

Miltex
Redefining Excellence

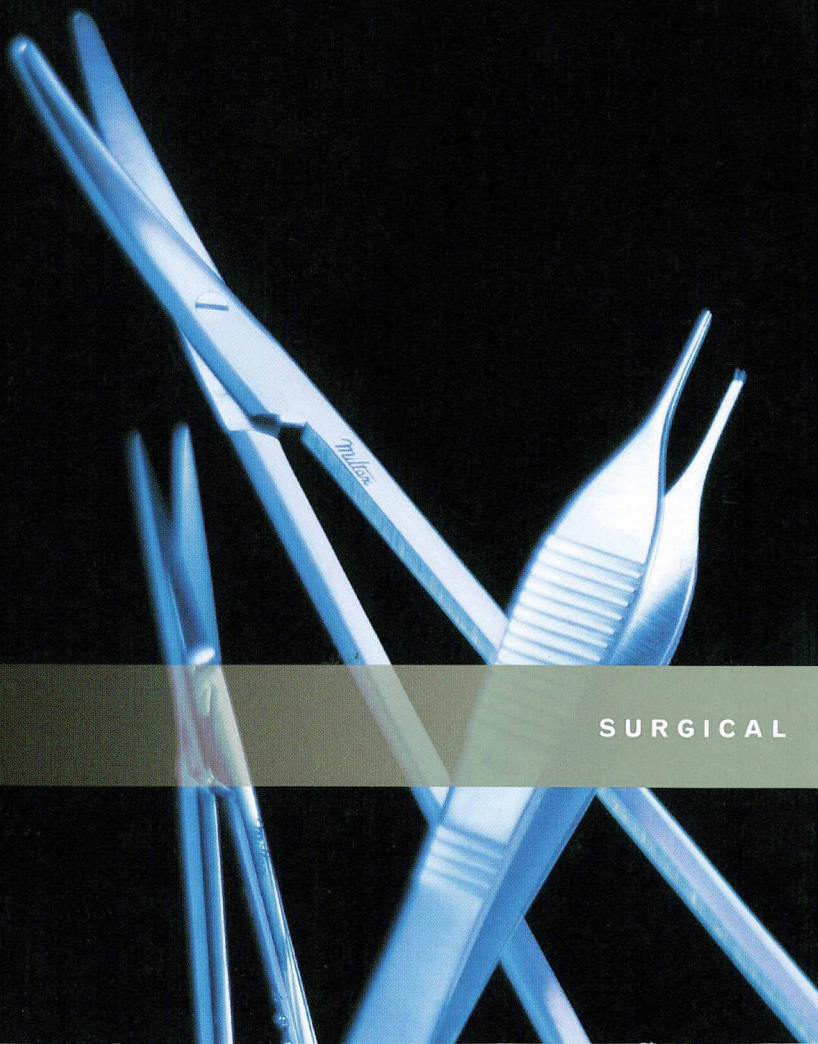

SURGICAL



Section Index

For complete alphabetical index see pages 598 to 614

For complete numerical index see pages 616 to 639

NewProducts..... NP1-NP21

	Page Nos.
Diagnostic Instruments	1-4
Anesthesia Instruments	5-7
Sterilizing Aids	8-10
Instrument Care Products	11
Tubing Forceps	12
Scalpel Blades and Handles	13-16
Disposable Scalpels	17
Operating Scissors	18-50
Bandage and Utility Scissors	51-52
Cast and Utility Shears	53
T-C Carb-N-Sert Scissors	54-59
SuperCut Scissors	60-63
Dressing and Tissue Forceps	64-82
Splinter Forceps	83-87
T-C Carb-N-Sert Dressing and Tissue Forceps	88-89
Hemostatic Forceps	90-108
Towel Clamps	109
Sponge Forceps	110-111
Needle Holders	112-121
T-C Carb-N-Sert Needle Holders	122-130
Surgical Needles	131-134
Suture Sundries	135-143
Probes and Directors	144-146
Suction Tubes	147-149
Vein Strippers	150
Retractors	151-187
Hooks	188-194

	Page Nos.
Thyroid-Goiter Instruments	195-197
Trocars and Biopsy Needles	198
Gall Bladder Instruments	199-205
Intestinal Instruments	206-214
Micro Surgery Instruments	215-224
Ophthalmic Instruments	225-268
Ear Instruments	269-288
Nasal Instruments	289-306
Plastic Surgery Instruments	307-346
Oral Instruments	347-354
Tonsil Instruments	355-361
Laryngeal Instruments	362-364
Bronchial and Esophageal Instruments	365-366
Tracheal Instruments	367-372
Atraumatic Instruments	373-387
Thoracic and Cardiovascular Instruments	388-408
Neurosurgical Instruments	409-439
Orthopedic Instruments	440-465
Cast Instruments	466-468
Rectal Instruments	469-481
Urological Instruments	482-488
Gynecological and Obstetrical Instruments	489-523
Dermal Instruments	524-551
Post Mortem Instruments	552-553
Suggested Surgical Instrument Sets	554-597

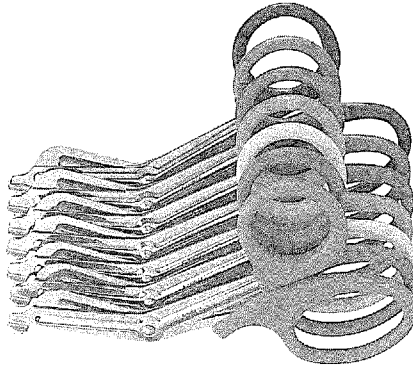

UNIVERSAL SCISSORS

- Highest quality German stainless steel construction
- Ideal for cutting bandages, gauze, tough clothing, cast material and metal sheets
- One serrated blade and comfortable contoured plastic handles
- Available in the popular 7-1/2" design and choose from seven colored handles

Part #	Description
5-1000	BLACK - Bandage & Utility Universal Scissors 7-1/2" (19.1 cm), with needle destroyer, black plastic finger rings, serrated blade. Autoclavable.
5-1025	RED - Bandage & Utility Universal Scissors 7-1/2" (19.1 cm), with needle destroyer, red plastic finger rings, serrated blade. Autoclavable.
5-1026	ORANGE - Bandage & Utility Universal Scissors 7-1/2" (19.1 cm), with needle destroyer, orange plastic finger rings, serrated blade. Autoclavable.
5-1027	BLUE - Bandage & Utility Universal Scissors 7-1/2" (19.1 cm), with needle destroyer, blue plastic finger rings, serrated blade. Autoclavable.
5-1028	PURPLE - Bandage & Utility Universal Scissors 7-1/2" (19.1 cm), with needle destroyer, purple plastic finger rings, serrated blade. Autoclavable.
5-1029	GREEN - Bandage & Utility Universal Scissors 7-1/2" (19.1 cm), with needle destroyer, green plastic finger rings, serrated blade. Autoclavable.
5-1030	YELLOW - Bandage & Utility Universal Scissors 7-1/2" (19.1 cm), with needle destroyer, yellow plastic finger rings, serrated blade. Autoclavable.

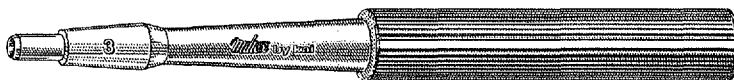

MILTEX® STERILE DISPOSABLE BIOPSY PUNCHES

- Individually packaged in color-coded, transparent, sturdy blister pack to protect cutting edge
- Seamless stainless steel razor sharp cutting edge
- Ribbed handle provides maximum control and comfort
- Sterile - ready to use every time
- Packed 50 Biopsy Punches to a Dispenser Box
- New 1/2 sizes

<u>Part #</u>	<u>Size</u>	<u>Part #</u>	<u>Size</u>
33-31AA	1.0 mm	33-33	3.5 mm
33-31A	1.5 mm	33-34	4.0 mm
33-31	2.0 mm	33-35	5.0 mm
33-31B	2.5 mm	33-36	6.0 mm
33-32	3.0 mm	33-37	8.0 mm

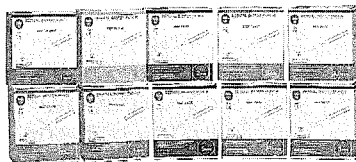

33-38 Assortment Box 10 each of the following sizes: 2mm, 3mm, 4mm, 5mm, 6mm

See page 526 for other related products.



4-510



4-511

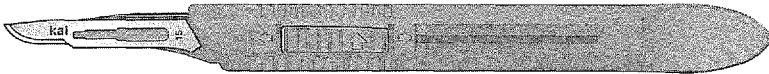

4-512

MILTEX® STERILE DISPOSABLE SAFETY SCALPEL

- Complies with OSHA directive for the Needlestick Safety and Prevention Act
- Stainless steel, sterile, single-use
- User activated and controlled mechanism - no springs to jam
- Audible confirmation when securely in desired position
- Metric ruler assists in determining length of incision
- Packed 10 per Box

Part #	Size
4-510	Size #10, Sterile, Single-Use
4-511	Size #11, Sterile, Single-Use
4-512	Size #15, Sterile, Single-Use



STEINMANN I.M. PINS (FOR INTRAMEDULLARY FIXATION)

- Ideal for immobilization of long bone fractures
- Manufactured from highest quality 316LVM stainless steel that is insert when implanted
- Precision ground trocar points with mirror finish
- Individually packaged and protected in clear cylinder tube

<u>Part #</u>	<u>Size</u>
---------------	-------------

27-182	Double Trocar Smooth - 1/16" x 7"
27-183	Double Trocar Smooth - 5/64" x 7"
27-184	Double Trocar Smooth - 3/32" x 8"
27-185	Double Trocar Smooth - 7/64" x 8"
27-186	Double Trocar Smooth - 1/8" x 9"
27-187	Double Trocar Smooth - 9/64" x 9"
27-188	Double Trocar Smooth - 5/32" x 10"
27-189	Double Trocar Smooth - 3/16" x 12"
27-190	Double Trocar Smooth - 1/4" x 12"
27-192	Double Trocar Partial Threaded - 1/16" x 7"
27-193	Double Trocar Partial Threaded - 5/64" x 7"
27-194	Double Trocar Partial Threaded - 3/32" x 8"
27-195	Double Trocar Partial Threaded - 7/64" x 8"
27-196	Double Trocar Partial Threaded - 1/8" x 9"
27-197	Double Trocar Partial Threaded - 9/64" x 9"
27-198	Double Trocar Partial Threaded - 5/32" x 10"
27-199	Double Trocar Partial Threaded - 3/16" x 12"
27-200	Double Trocar Partial Threaded - 1/4" x 12"

See pages 444-445 for Kirschner Wire (K-Wire), Pin Cutters, Pin Pullers and other accessories.

27-201	Miltex Pin and Wire Gauge - measures Steinmann Pins, K-Wire, drill bits and bone screws. (Includes 6" ruler)
--------	--

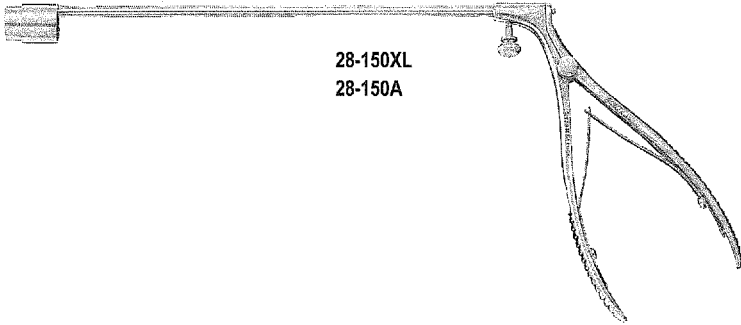

28-150XL
28-150A

RECTAL INSTRUMENTS

Part #	Description
---------------	--------------------

28-150XL	McGIVNEY Hemorrhoidal Ligator, 10" shaft, includes Ligating Rings and Loading Cone - Large
-----------------	--

28-150A	McGIVNEY Hemorrhoidal Ligator Set - includes McGIVNEY Hemorrhoidal Ligator 7" shaft, McGIVNEY Grasping Forceps 7-1/2", Ligating Rings, and Loading Cone - Large
----------------	---

See page 475 for the complete line of McGivney patterns.

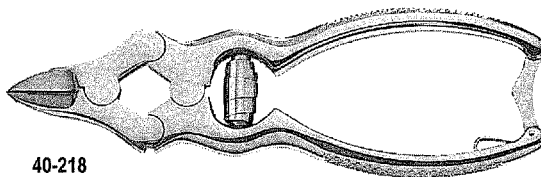

DERMAL/PODIATRY INSTRUMENT

- Double action allows for greater strength and control when cutting heavy nails
- Stainless steel construction
- Non-slip serrated grip handle
- Autoclavable

Part #	Description
---------------	--------------------

40-218	Double Action Nail Nipper, 6" (15.2 cm), straight jaws
---------------	--

See page 549 for curved pattern.



4-405

SCALPEL HANDLE

Part #	Description
---------------	--------------------

4-405	Self Locking Chisel Blade Handle
--------------	----------------------------------

See pages 13-14 for a complete line of scalpel handles.

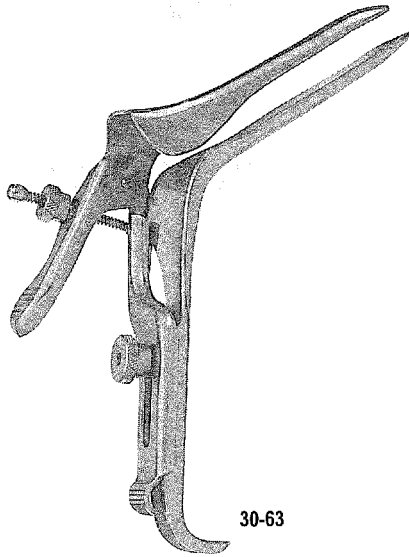

30-63

PEDERSON OPEN-SIDED VAGINAL SPECULA

Part #	Description
30-63	PEDERSON (Right) Open-Sided Vag. Spec, Narrow Blades (3-1/2" x 7/8") (8.9 cm x 2.2 cm)

See page 490 for a complete line of Pederson specula.



31-14
31-16



31-48
31-49
31-50
31-51

MILTEX INSULATED INSTRUMENTS FOR ELECTROSURGICAL PROCEDURES

- Ideally suited for LEEP/LLETZ
- Highest quality German crafted instruments thermally insulated with a superior, non-conductive blue nylon coating
- Exceeds high voltage testing requirements
- Autoclavable (carefully follow Miltex Care & Handling Instructions, supplied with instrument)
- Limited 1-year warranty against defects in workmanship and material

Part #	Description
---------------	--------------------

31-14	LEEP Dressing Forceps 8" (20.3cm) long, Serrated with Coated Tips
31-16	LEEP Dressing Forceps 10" (25.4cm) long, Serrated with Coated Tips
31-48	LEEP Tissue Forceps 8" (20.3cm) long, 1x2 Teeth with Exposed Tips
31-49	LEEP Tissue Forceps 8" (20.3cm) long, 1x2 Teeth with Coated Tips
31-50	LEEP Tissue Forceps 10" (25.4cm) long, 1x2 Teeth with Exposed Tips
31-51	LEEP Tissue Forceps 10" (25.4cm) long, 1x2 Teeth with Coated Tips

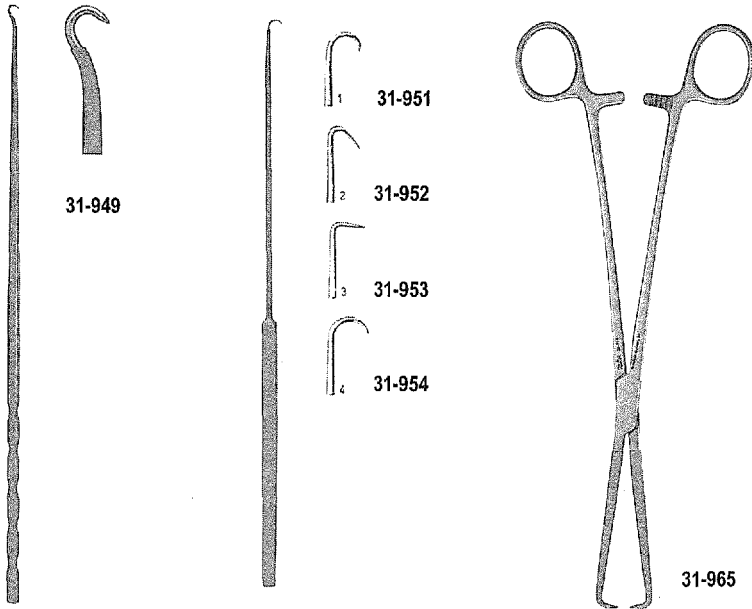

Part #	Description
31-949	LEEP Iris Hook 10" (25.4cm) long, Small delicate Exposed Tip with 4mm hook
31-951	LEEP Emmett Tenaculum Hook, 9" (22.9cm) long, Style 1 (half curved - small) with Exposed Tip
31-952	LEEP Emmett Tenaculum Hook, 9" (22.9cm) long, Style 2 (acute angle) with Exposed Tip
31-953	LEEP Emmett Tenaculum Hook, 9" (22.9cm) long, Style 3 (right angle) with Exposed Tip
31-954	LEEP Emmett Tenaculum Hook, 9" (22.9cm) long, Style 4 (half curved - large) with Exposed Tip
31-965	LEEP Schroeder-Braun Tenaculum Forceps 9-3/4" (24.8cm) long, straight with coated tips

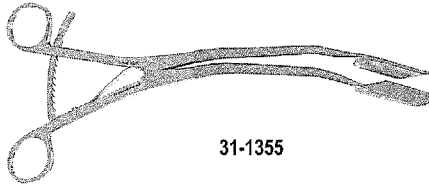
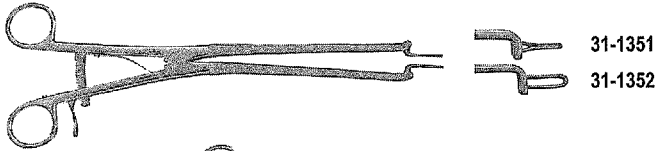

31-1355

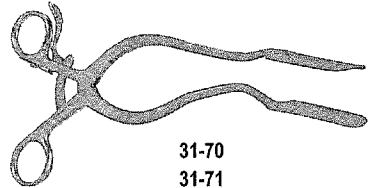

31-70

31-71

Part # Description

- 31-1351 LEEP Miltex-Kogan Endocervical Speculum 10-3/4" (27.3cm) long, Narrow Tip Coated (3.2mm x 25mm), with Grip-Lock Ratchet & Gauge
- 31-1352 LEEP Miltex-Kogan Endocervical Speculum 10-3/4" (27.3cm) long, Regular Tip Coated (7.2mm x 25mm), with Grip-Lock Ratchet & Gauge
- 31-1353 LEEP Kogan Endocervical Speculum 10-3/4" (27.3cm) long, Narrow Tip Coated (3.2mm x 25mm) (Standard Ratchet Pattern)
- 31-1354 LEEP Kogan Endocervical Speculum 10-3/4" (27.3cm) long, Regular Tip Coated (7.2mm x 25mm) (Standard Ratchet Pattern)
- 31-1355 LEEP Lateral Vaginal Retractor 8-1/4" (21cm) long, with Extra Long Thumb Ratchet (22mm x 57mm blade)
- 31-70 LEEP Redundant Wall Vaginal Retractor 7-3/4" (19.5cm) long, Medium 22mm x 57mm blade
- 31-71 LEEP Redundant Wall Vaginal Retractor 7-3/4" (19.5cm) long, Large 22mm x 75mm blade

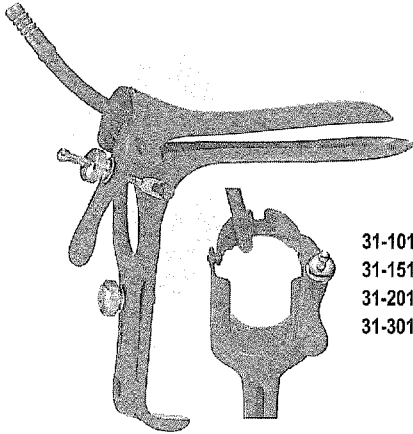

31-101
31-151
31-201
31-301

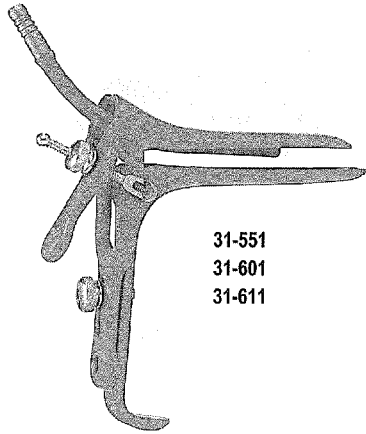

31-551
31-601
31-611

Part #	Description
---------------	--------------------

- | | |
|--------|--|
| 31-101 | LEEP Graves Speculum Small (3" x 7/8") (7.6 cm x 2.2 cm) with Smoke Evacuation Tube (2.8cm opening) |
| 31-151 | LEEP Graves Speculum Medium (4" x 1-1/4") (10.2 cm x 3.2 cm) with Smoke Evacuation Tube (2.8cm opening) |
| 31-201 | LEEP Graves Speculum Large (4-1/2" x 1-3/8") (11.4 cm x 3.5 cm) with Smoke Evacuation Tube (2.8cm opening) |
| 31-301 | LEEP Graves Speculum X-Large (6-3/4" x 1-3/8") (17.1 cm x 3.5 cm) with Smoke Evacuation Tube (2.8cm opening) |
| 31-551 | LEEP Pederson Speculum Medium (4" x 7/8") (10.2 cm x 2.2 cm) with Smoke Evacuation Tube (2.8cm opening) |
| 31-601 | LEEP Pederson Speculum Large (4-3/4" x 1") (12.1 cm x 2.5 cm) with Smoke Evacuation Tube (2.8cm opening) |
| 31-611 | LEEP Pederson Speculum X-Large (6-3/4" x 1") (17.1 cm x 2.5 cm) with Smoke Evacuation Tube (2.8cm opening) |

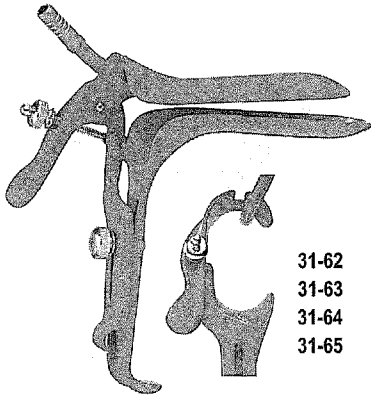

31-62
31-63
31-64
31-65

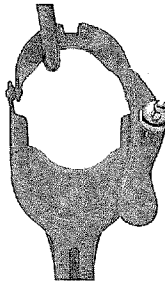

31-66
31-67

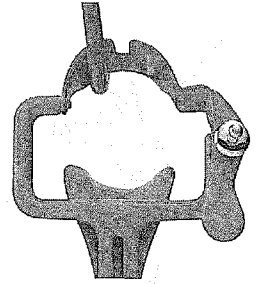

31-68
31-69

Part #	Description
31-62	LEEP Pederson (Right) Open-Sided Speculum Medium (4" x 7/8") (10.2 cm x 2.2 cm) with Smoke Evacuation Tube (2.8cm opening)
31-63	LEEP Pederson (Right) Open-Sided Speculum Large (4-1/2" x 1") (11.4 cm x 2.5 cm) with Smoke Evacuation Tube (2.8cm opening)
31-64	LEEP Graves Open-Sided (Right) Speculum Medium (4" x 1-1/4") (10.2 cm x 3.2 cm) with Smoke Evacuation Tube (2.8cm opening)
31-65	LEEP Graves Open-Sided (Right) Speculum Large (4-1/2" x 1-3/8") (11.4 cm x 3.5 cm) with Smoke Evacuation Tube (2.8cm opening)
31-66	LEEP Graves View-More Speculum Medium (4" x 1-1/4") (10.2 cm x 3.2 cm) with Smoke Evacuation Tube (4.0cm yoke opening)
31-67	LEEP Graves View-More Speculum Large (4-1/2" x 1-3/8") (11.4 cm x 3.5 cm) with Smoke Evacuation Tube (4.0cm yoke opening)
31-68	LEEP Graves Maxi-View Speculum Medium (4" x 1-1/4") (10.2 cm x 3.2 cm) with Smoke Evacuation Tube (7.0cm yoke opening)
31-69	LEEP Graves Maxi-View Speculum Large (4-1/2" x 1-3/8") (11.4 cm x 3.5 cm) with Smoke Evacuation Tube (7.0cm yoke opening)



New Products



31-5000

31-5002



31-5022

31-5024



31-5054

31-5070

31-5074

31-5092

31-5096

31-5056

31-5072

31-5090

31-5094

31-5098

Part # Description

31-5000	Sterile Disposable Electrode, Ball 3mm Diameter (Box of 5)
31-5002	Sterile Disposable Electrode, Ball 5mm Diameter (Box of 5)
31-5022	Sterile Disposable Electrode, Square (10mm width x 8mm depth) (Box of 5)
31-5024	Sterile Disposable Electrode, Square (10mm width x 10mm depth) (Box of 5)
31-5054	Sterile Disposable Electrode, Loop (10mm width x 8mm depth) (Box of 5)
31-5056	Sterile Disposable Electrode, Loop (10mm width x 10mm depth) (Box of 5)
31-5070	Sterile Disposable Electrode, Loop (15mm width x 5mm depth) (Box of 5)
31-5072	Sterile Disposable Electrode, Loop (15mm width x 8mm depth) (Box of 5)
31-5074	Sterile Disposable Electrode, Loop (15mm width x 10mm depth) (Box of 5)
31-5090	Sterile Disposable Electrode, Loop (20mm width x 8mm depth) (Box of 5)
31-5092	Sterile Disposable Electrode, Loop (20mm width x 10mm depth) (Box of 5)
31-5094	Sterile Disposable Electrode, Loop (20mm width x 12mm depth) (Box of 5)
31-5096	Sterile Disposable Electrode, Loop (20mm width x 15mm depth) (Box of 5)
31-5098	Sterile Disposable Electrode, Loop (20mm width x 20mm depth) (Box of 5)



1



2



3



15G



1V



2V



3V

PODIATRY AND DERMATOLOGY BLADES

Stainless Steel specialty surgical blades –

Sterile, individually sealed in blister packs, 20 blades per box.

<u>Cat#</u>	<u>Size</u>	<u>Uses</u>
4-601	#1	Debridement of calloused nail groves
4-602	#2	Biopsy of small cutaneous lesions
4-603	#3	Removal of plantar warts
4-604	#15G	Debridement of heel callus
4-605	#1V	Removal of foreign bodies
4-606	#2V	Enucleation of callus with painful core
4-607	#3V	Used for a variety of work on the cuticle and corns



4-406

MEDI-KLINGEN BLADE HANDLE

4-406 MEDI - KLINGEN BLADE HANDLE with chuck, 5" (12.7cm)



3-750



19-113



19-115



19-117

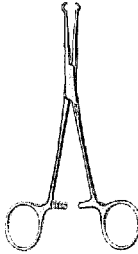

29-805

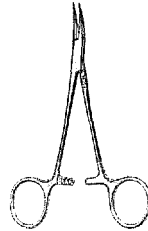

29-850



30-1384

EZ-ZYME™ ALL PURPOSE ENZYME CLEANER

3-750 3/4oz. packets – box of 32. Each packet makes a gallon of solution. Proven in a Major University Study to be the most effective enzyme cleaner against a group of competitors.

STUDENT GRADE TUNING FORKS

- 19-113** C-128 vibrations
- 19-115** C-256 vibrations
- 19-117** C-512 vibrations

NO SCALPEL VASECTOMY INSTRUMENTS

- 29-805** No Scalpel Vasectomy Ring Clamp 5 1/2" (14cm), gold finger rings
- 29-850** No Scalpel Vasectomy Hemostat 5 1/2" (14cm), smooth sharp point, curved, gold finger rings
- 29-855** No Scalpel Vasectomy Instrument Set - One of each

TOWNSEND ENDOCERVICAL BIOPSY CURETTE

- 30-1384** 12" (30.5cm), loop size 1 X 7 mm

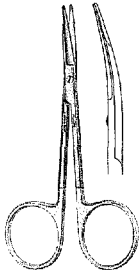

5-269TC

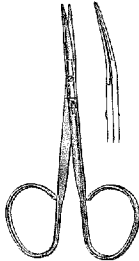

5-263*

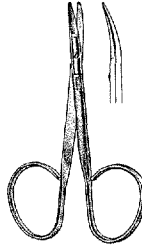

5-400*



6-127

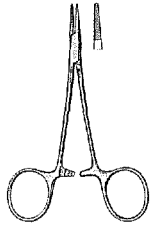

8-3TC

- 5-269TC** KAYE Dissecting Scissors 4 1/2" (11.5cm), curved, one serrated blade, CARB-N-SERT blade
- 5-263*** KAYE Fine Dissecting Scissors 4 11/32" (11cm), serrated blades, ribbon type
- 5-400*** MILTEX Utility Scissors 4 1/16" (10.3cm), curved blunt tips, ribbon type
- 6-127** GRIFFITHS-BROWN Tissue Forceps 4 11/32" (11cm), delicate, 1.5 X 5mm Brown-type teeth
- 8-3TC** PAR Needle Holder 4 1/2" (11.4cm), delicate serrated jaws 16000 teeth p. sq. inch, CARB-N-SERT jaws
- 8-5TC** PAR Needle Holder 5" (12.7cm), delicate serrated jaws 16000 teeth p. sq. inch, CARB-N-SERT jaws

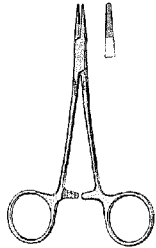

8-5TC

**Ribbon Type Scissors have extra large finger rings; shanks and rings have satin finish; blades are highly polished*



New Products

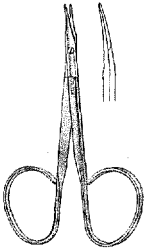

9-115*

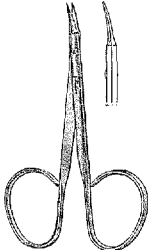

9-116*

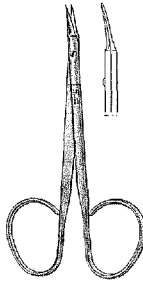

9-117*

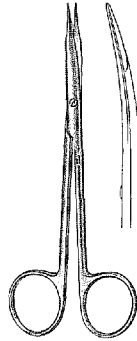

18-1455

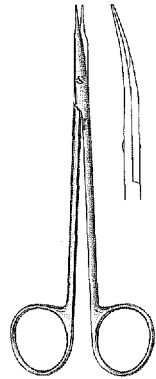

18-1456

9-115* REEH Stitch Scissors 3 7/8" (9.8cm), sharp tips, small hook at end of one blade, ribbon type

9-116* MILTEX Stitch Scissors 3 7/8" (9.8cm), curved, sharp pointed tips, ribbon type

9-117* MILTEX Stitch Scissors 4 7/8" (12.4cm), curved, sharp pointed tips, ribbon type

18-1455 STEVENS Tenotomy Scissors 5 1/2" (14.3cm), curved

18-1456 STEVENS Tenotomy Scissors 6 1/4" (15.9cm), curved

18-SC-1652 SUPERCUT Gradle (Eye Suture) Scissors 3 3/4" (9.5cm), curved

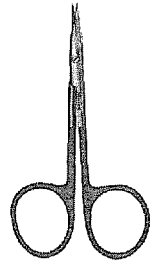

18-SC-1652

**Ribbon Type Scissors have extra large finger rings; shanks and rings have satin finish; blades are highly polished*

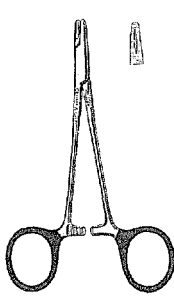

8-4CG

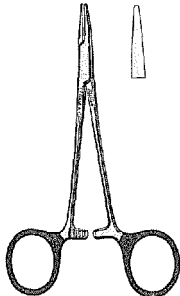

**8-6CG
8-7CG**

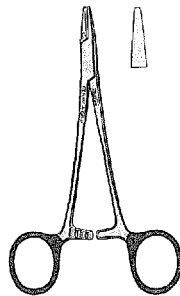

8-8CG

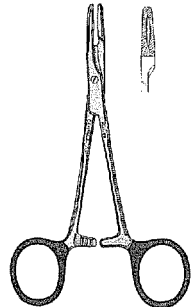

**8-15CG
8-16CG**

CERAM-A-GRIP® NEEDLE HOLDERS

Miltex Ceram-A-Grip® needleholders feature a patented ceramic material that is fusion bonded to the jaw to improve and increase jaw gripping power.

8-4CG DERF 4 3/4" (12.1cm)

8-6CG WEBSTER 5" (12.7cm), delicate, smooth jaws, standard pattern

8-7CG WEBSTER 4 3/4" (12.1cm), extra delicate, smooth jaws

8-8CG HALSEY 5" (12.7cm), smooth jaws

8-15CG OLSEN-HEGAR 5 1/2" (14cm), needle holder/scissors combination

8-16CG OLSEN-HEGAR 6 1/2" (16.5cm), needle holder/scissors combination

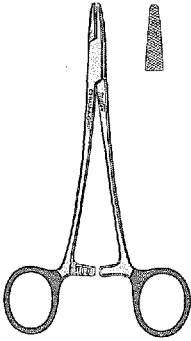

8-40CG

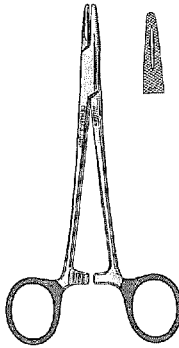

**8-42CG
8-44CG
8-46CG
8-48CG**

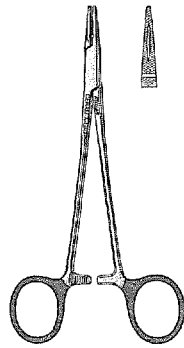

**8-50CG
8-51CG
8-52CG**

CERAM-A-GRIP® NEEDLE HOLDERS

Miltex Ceram-A-Grip® needleholders feature a patented ceramic material that is fusion bonded to the jaw to improve and increase jaw gripping power.

- | | |
|---------------|---------------------------|
| 8-40CG | BAUMGARTNER 5 1/2" (14cm) |
| 8-42CG | MAYO-HEGAR 5" (12.7cm) |
| 8-44CG | MAYO-HEGAR 6" (15.2cm) |
| 8-46CG | MAYO-HEGAR 7" (17.8cm) |
| 8-48CG | MAYO-HEGAR 8" (20.3cm) |
| 8-50CG | CRILE-WOOD 6" (15.2cm) |
| 8-51CG | CRILE-WOOD 7" (17.8cm) |
| 8-52CG | CRILE-WOOD 8" (20.3cm) |

DISPOSABLE EAR CURETTES

Packaged 50/Box



19-320 Ring Tip
19-321 Loop Tip
19-322 Small Spoon Tip
19-323 Large Spoon Tip

FEATURES

- Four Styles of Tips
- Directional Arrow for Correct Placement
- Handle Scored for Finger Placement and Control
- Atraumatic Design
- Single Use - Non Sterile
- Individually Packaged
- Packaged 50 per Dispenser Box

DISPOSABLE DERMAL CURETTES

Packaged 50/Box

33-52 2mm
33-53 3mm
33-54 4mm
33-55 5mm
33-57 7mm

FEATURES

- Five Sizes
- Size marked on every curette
- Curette blade manufactured from beveled surgical grade stainless steel
- Sturdy handle
- Sterile, disposable
- Cost-effective
- Convenient packaging

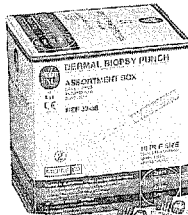

NP 20

DISPOSABLE BIOPSY PUNCHES - ASSORTED

Packaged 50/Box

10 each of the following sizes: 2mm, 3mm, 4mm, 5mm, 6mm
Color Coded by size

33-38 Assortment Box - Biopsy Punches

FEATURES

- Individually packaged in color-coded, transparent, sturdy blister pack to protect cutting edge
- Seamless stainless steel razor sharp cutting edge
- Ribbed handle provides maximum control and comfort

See page 526 for other available sizes



Miltex Edge™ Scissors Sharpener 5-5000

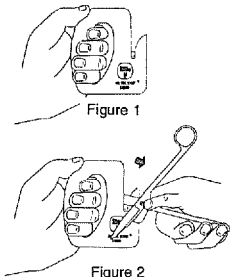
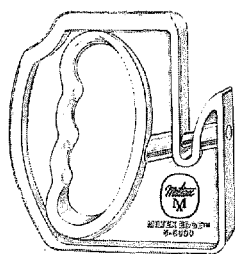

Figure 1

Figure 2

Miltex Nip-It™ Nipper and Bone Cutting Forceps Sharpener 5-5010

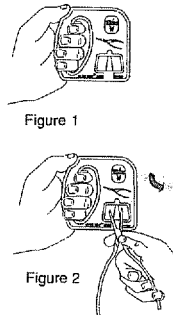
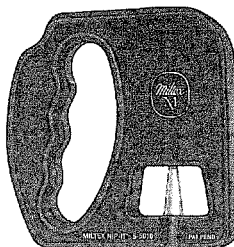

Figure 1

Figure 2

*Not intended for serrated or SuperCut Scissors

Tip-It™ Instrument Guards

Tip-It™ Instrument Guards are used to protect instrument tips and edges from damage during instrument handling and sterilization. Steam and Gas Sterilizable. Radiopaque and Latex Free. 50 per pack

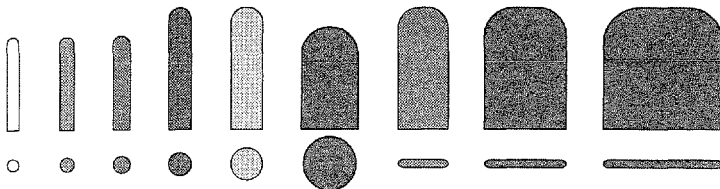

PRODUCT NUMBER

DIMENSION

SIZE CODE

COLOR

3-2501	1/16" x 3/4" (1.6mm x 19mm)	1	White
3-2502	5/64" x 3/4" (2mm x 19mm)	2	Blue
3-2503	7/64" x 3/4" (2.8mm x 19mm)	3	Green
3-2504	1/8" x 1" (3.2mm x 25.4mm)	4	Red
3-2505	3/16" x 1" (4.8mm x 25.4mm)	5	Yellow
3-2506	13/32" x 3/4" (10.3mm x 19mm)	6	Maroon
3-2507	1/16" x 3/8" x 1" (1.6mm x 9.5mm x 25.4mm)	7	Orange
3-2508	5/64" x 5/8" x 1" (2mm x 16mm x 25.4mm)	8	Brown
3-2509	1/8" x 1" x 1" (3.2mm x 25.4mm x 25.4mm)	9	Black
3-2510	Assorted, equal number of above, plus 5		



Diagnostic Instruments

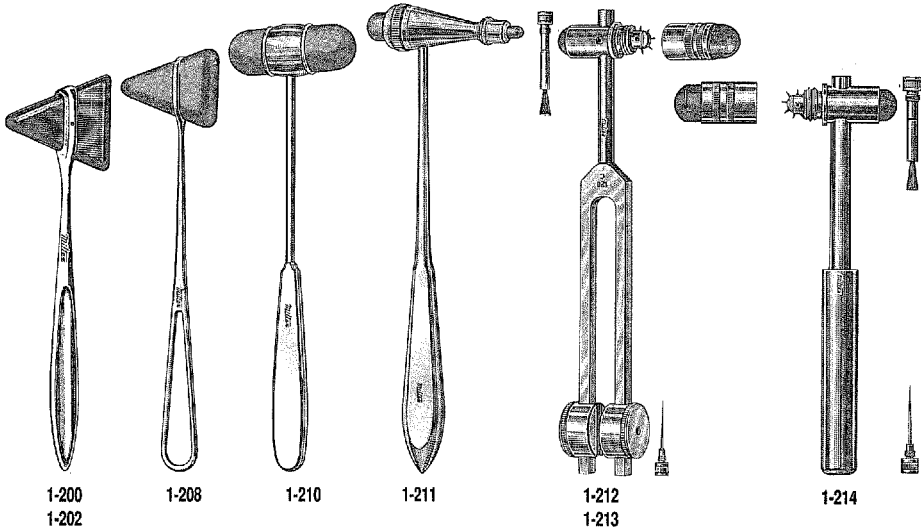

- 1-200 TAYLOR Percussion Hammer 7" (17.8 cm), Pediatric Size, solid handle
- 1-202 TAYLOR Percussion Hammer 7 1/2" (19.1 cm), Standard Size, solid handle, chrome
- 1-208 TAYLOR Percussion Hammer 9" (22.9 cm), Large Head, loop handle, chrome
- 1-210 DEJERINE Percussion Hammer 9 1/2" (24.1 cm), chrome
- 1-211 TROMNER Percussion Hammer 9 3/4" (24.8 cm), with Large and Small Rubber Tips, hollow tapered handle with sharp point, chrome

- 1-212 COMBO-5 Neuro Diagnostic Set (C-128 Tuning Fork, Buck Hammer, Pin Wheel, Brush and Needle)
- 1-213 COMBO-5 Neuro Diagnostic Set (C-256 Tuning Fork, Buck Hammer, Pin Wheel, Brush and Needle)
- 1-214 COMBO-4 Neuro Diagnostic Set (Buck Hammer, Pin Wheel, Brush and Needle)

- 1-220 BUCK Neurological Hammer 7 3/4" (19.7 cm), with Brush and Needle (screw into handle), chrome

- 1-222 RABINER Neurological Hammer 9" (22.9 cm), with Brush and Needle (screw into handle), chrome

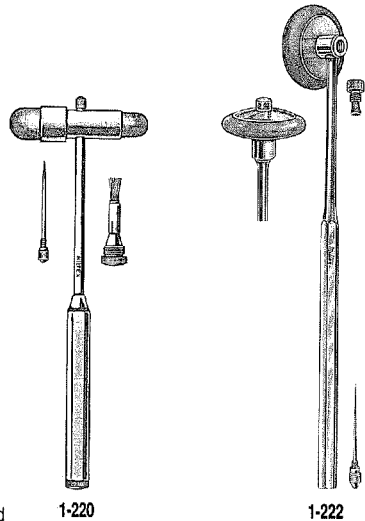



19-100

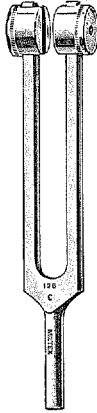

19-102

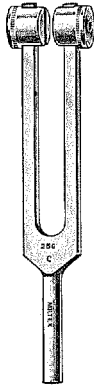

19-104



19-106

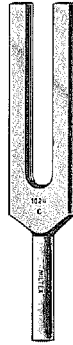

19-108



19-110

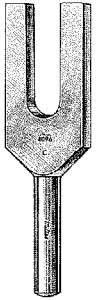

19-112

**MILTEX TUNING FORKS,
Aluminum Alloy**

- 19-100 C-64 vibrations
- 19-102 C-128 vibrations
- 19-104 C-256 vibrations
- 19-106 C-512 vibrations
- 19-108 C-1024 vibrations
- 19-110 C-2048 vibrations
- 19-112 C-4096 vibrations

19-120 Set of 5 Tuning Forks,
C-128, C-256, C-512,
C1024 and C-2048 in
fitted zippered case

19-120A Fitted zippered case only
for tuning fork set

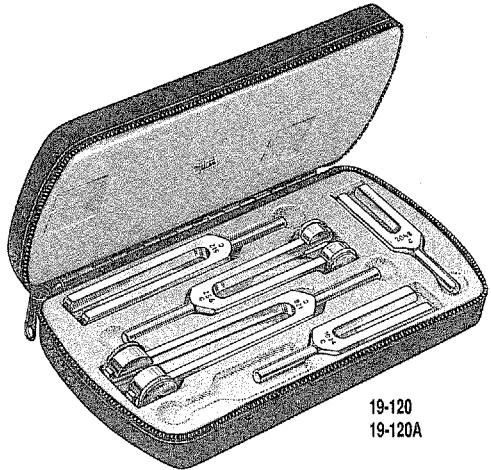

19-120
19-120A

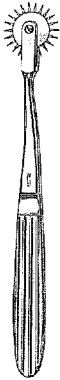

1-226

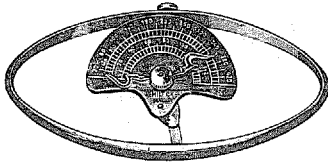

1-228

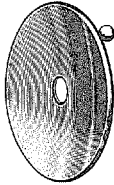

1-242
1-243

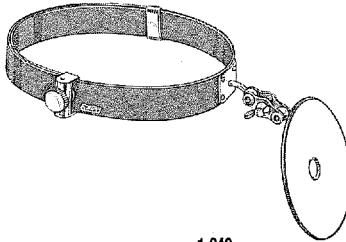

1-240
1-244



1-3000

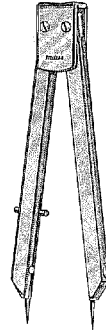

1-3005

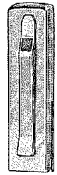

- 1-226 WARTENBERG Neurological Pin Wheel 7" (17.8 cm)
- 1-228 COLLIN Dynamometer, Adult size, 5" x 2 1/4" (12.7 x 5.7 cm)
- 1-240 FRANKEL Head Band and Mirror Set. Includes Standard 3 1/2" (8.9 cm) dia. mirror with 1/2" (1.3 cm) aperture and improved model Frankel Head Band No. 1-244
- 1-242 MILTEX Head Mirror, Standard size 3 1/2" (8.9 cm) dia. with 1/2" (1.3 cm) aperture, boilable
- 1-243 MILTEX Head Mirror, Small size 3" (7.6 cm) dia. with 5/8" (1.6 cm) aperture, boilable
- 1-244 FRANKEL Head Band, Black fibre material, improved pattern with secure thumb screw size adjustment; includes swivel mirror connector
- 1-3000 EKG Caliper, with protective metal cap, graduated in mm, and ring, satin chrome finish
- 1-3005 EKG Caliper, with protective metal cap, graduated in mm, and pocket clip, satin chrome finish
- 1-3015 EKG Caliper, Economy line, with protective black plastic cap, graduated in mm, nickel plated

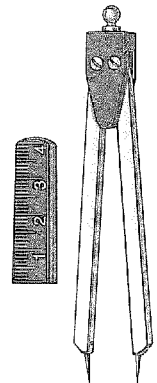

1-3015



1-3200

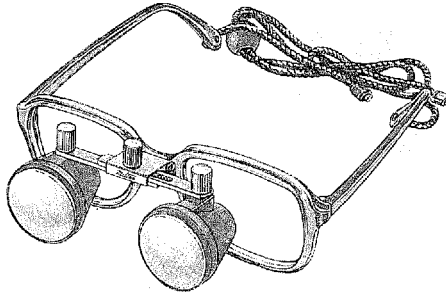

1-4000
1-4006



1-4010

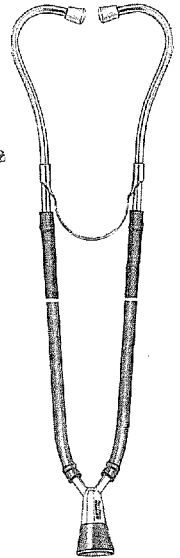

1-4

- 1-3200 MILTEX Fibreglass Tape Measure, 1/4" (6.4 mm) wide, graduated to 60" (152.4 cm) on one side, to 150 cm on other side. Plastic case with pushbutton tape return
- 1-4000 MILTEX Binocular Magnifying Loupe, lightweight, coated optics 1.8X magnification, 30 cm focal distance, 10 cm viewing area, pupillary distance adjustment, mounted on spectacle frame. With carrying case
- 1-4006 MILTEX Binocular Magnifying Loupe, same as No. 1-4000, but without spectacle frame and without case
- 1-4010 Accessory Clip-On Lenses, for No. 1-4000 and 1-4006 Loupes, increasing magnification to 2.5X, with 17 cm focal distance, 4.5 cm viewing area
- 1-4 FORD Stethoscope with shallow bell and plastic ear tips, chrome



2-20

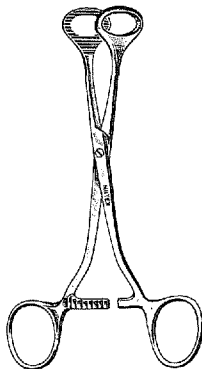

2-50

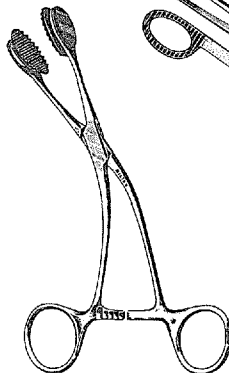

2-60
2-62

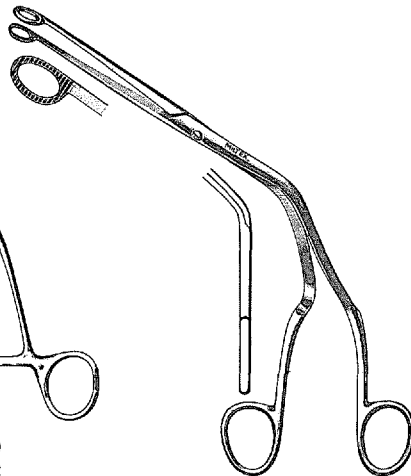

2-70
2-72

- 2-20 MAUNDER Oral Screw, white plastic
- 2-50 COLLIN Tongue Seizing Forceps 6 3/4" (17.1 cm) jaws 25mm wide
- 2-60 YOUNG Tongue Seizing Forceps 6 1/2" (16.5 cm), with soft rubber jaws
- 2-62 RUBBER JAWS for Young Tongue Forceps
- 2-70 MAGILL Endotracheal Catheter Introducing Forceps 9" (22.9 cm), adult size
- 2-72 MAGILL Endotracheal Catheter Introducing Forceps 7" (17.8 cm), child size
- 2-104 YANKAUER Suction Tube 11 3/4" (29.8 cm), with removable tip and tubing connection, chrome
- 2-104SS YANKAUER Suction Tube 11 3/4" (29.8 cm), with removable tip and tubing connection
- 2-106 Tip for YANKAUER Suction Tube, chrome
- 2-106SS Tip for YANKAUER Suction Tube

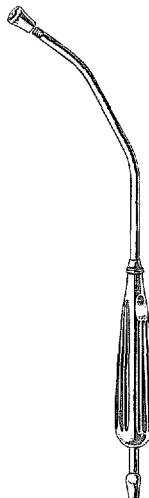

2-104
2-104SS



2-106
2-106SS

Anesthesia Instruments

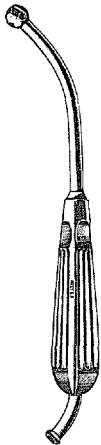

2-100

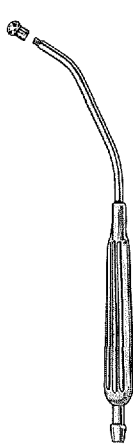

2-109

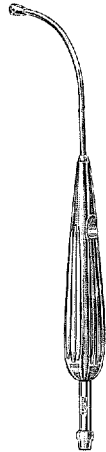

2-110
2-110SS

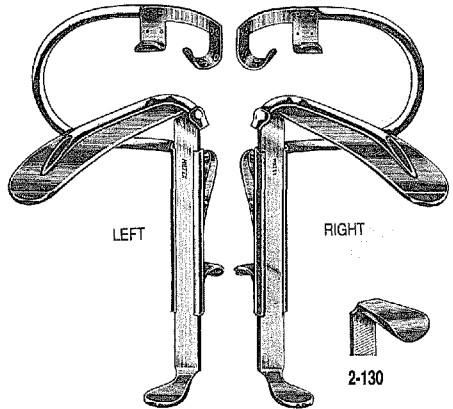

LEFT

RIGHT

2-130

2-120 to 2-122
2-132 to 2-138A

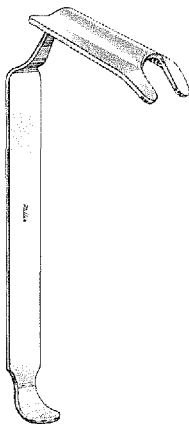

2-140 to 2-147

- 2-100** PYNCHON Suction Tube 11" (27.9 cm), tip with large openings, with removable tubing connection, chrome
- 2-109** YANKAUER Pediatric Suction Tube 8 1/2" (21.6 cm), with removable tip, delicate pattern
- 2-110** ANDREWS-PYNCHON Suction Tube 10" (25.4 cm), delicate pattern, chrome
- 2-110SS** ANDREWS-PYNCHON Suction Tube 10" (25.4 cm), delicate pattern
- 2-120** DAVIS Mouth Gag 6 1/4" (15.9 cm), double bite, left, without blades
- 2-122** DAVIS Mouth Gag 6 1/4" (15.9 cm), double bite, right, without blades

BLADES FOR DAVIS OR McIVOR MOUTH GAGS

W/o Ether Tube	Size No.	Size		W/Ether Tube
2-130	1	3/4" x 1" (1.9 x 2.5 cm)	Tooth Plate	—
2-132	2	1" x 2 3/4" (2.5 x 7 cm)	Tongue Blade	2-132A
2-134	3	1" x 3 1/4" (2.5 x 8.3 cm)	Tongue Blade	2-134A
2-136	4	1" x 3 3/4" (2.5 x 9.5 cm)	Tongue Blade	2-136A
2-138	5	1" x 4" (2.5 x 10.2 cm)	Tongue Blade	2-138A

RING TONGUE RETRACTOR BLADES

For use with Davis or McIvor Mouth Gags. Grooved blade holds endotracheal tube firmly in place.

Left	Size No.	Size	Right
2-140	2	7/8" x 2 1/4" (2.2 x 5.7 cm)	2-144
2-141	3	1 1/8" x 3" (2.9 x 7.6 cm)	2-145
2-142	4	1 1/4" x 3 1/2" (3.2 x 8.9 cm)	2-146
2-143	5	1 1/2" x 3 3/4" (3.8 x 9.5 cm)	2-147

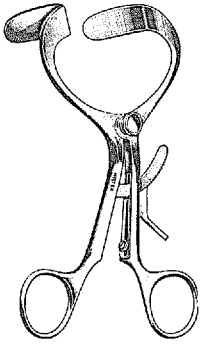

2-150

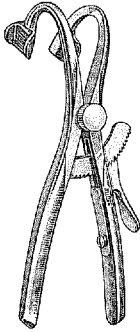

2-154

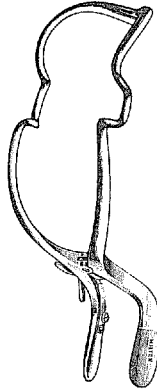

2-160
2-162
2-164

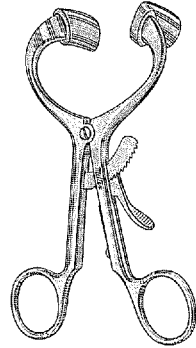

63-10
63-15
63-20

2-150 DOYEN-JANSEN Mouth Gag 5½" (14 cm), with grip lock

2-154 DENHARDT Mouth Gag 5" (12.7 cm), with grip lock

2-160 JENNINGS Mouth Gag, adult size, 6" (15.2 cm) wide

2-162 JENNINGS Mouth Gag, child size, 4¾" (12.1 cm) wide

2-164 JENNINGS Mouth Gag, infant size, 3¾" (9.5 cm) wide

2-180 McIVOR Mouth Gag, 5¾" (14.6 cm), complete with 3 tongue blades, one each Nos. 2-132, 2-134 and 2-136

2-182 McIVOR Mouth Gag, 5¾" (14.6 cm), frame only

MOLT Mouth Gags with silicone guards

63-10 Pediatric 4" (10.7 cm)

63-15 Child 4½" (11.4 cm)

63-20 Adult 5½" (14 cm)

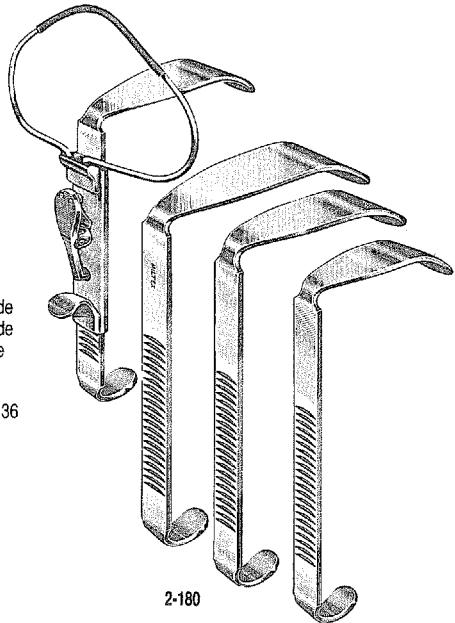

2-180

Sterilizing Aids

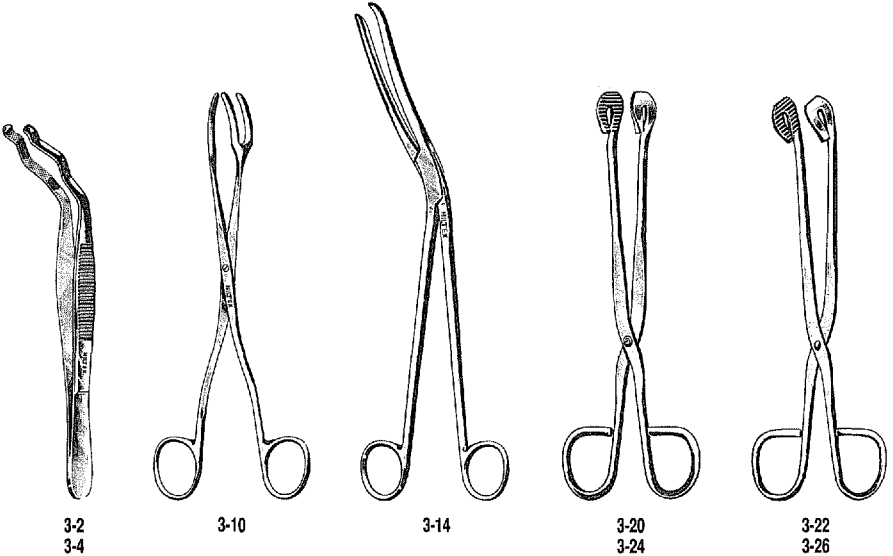

- 3-2 DAVIS Sterilizer Forceps 6" (15.2 cm)
- 3-4 DAVIS Sterilizer Forceps 10" (25.4 cm)
- 3-10 Three Prong Sterilizer Forceps 8" (20.3 cm)
- 3-14 CHEATLE Sterilizer Forceps 11" (27.9 cm)
- 3-20 Utility-Sterilizer Forceps 8" (20.3 cm), straight
- 3-22 Utility-Sterilizer Forceps 8" (20.3 cm), curved
- 3-24 Utility-Sterilizer Forceps 11" (27.9 cm), straight
- 3-26 Utility-Sterilizer Forceps 11" (27.9 cm), curved
- 3-50 Sterilizer Spiral Rack for surgical needles
- 3-60 BUNT Forceps Holder
- 65-25 Grasping Forceps 6 1/4" (15.9 cm)
Designed to grasp instruments from the ultrasonic and cold sterilization solution trays, containers and baskets.

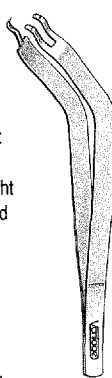

65-25

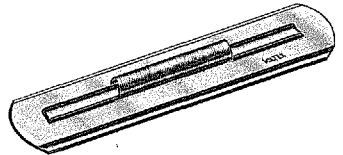

3-50

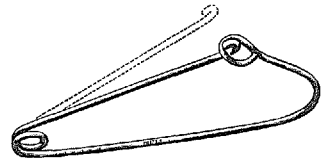

3-60



Sterilizing Aids

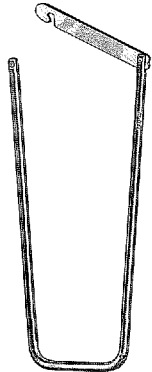

3-70 to 3-74

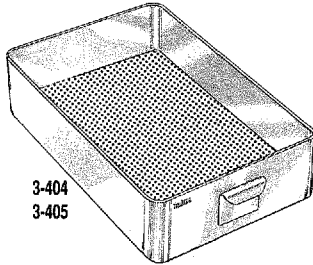

3-404
3-405

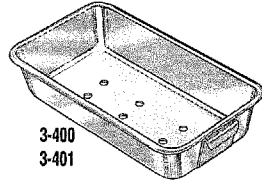

3-400
3-401

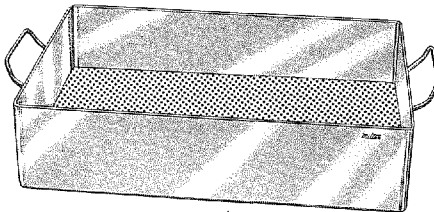

3-499 to 3-502

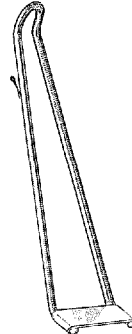

3-402



65-28

- 3-70 MILTEX Forceps Holder 8" (20.3 cm), with secure locking device
- 3-71 MILTEX Forceps Holder 10" (25.4 cm), with secure locking device
- 3-72 MILTEX Forceps Holder 12" (30.5 cm), with secure locking device
- 3-74 MILTEX Forceps Holder 16" (40.6 cm), with secure locking device

- 3-400 Flash Autoclaving Pan 9" x 5" x 2" (22.9 x 12.7 x 5.1 cm) with drainage holes, including safety handle
- 3-401 Flash Autoclaving Pan only
- 3-402 Safety Handle only
- 3-404 Flash Autoclaving Tray 10" x 6 1/2" x 2 1/2" (25.4 x 16.5 x 6.4 cm) with perforated bottom, including safety handle
- 3-405 Flash Autoclaving Tray only

INSTRUMENT STERILIZING TRAYS

With handles. Rolled safety edges. Perforated bottoms assure complete steam penetration with no build-up of condensation.

- 3-499 Outside Dimensions 10" x 6 1/2" x 2 1/2" (25.4 x 16.5 x 6.4 cm)
- 3-500 Outside Dimensions 10" x 10 1/2" x 3 1/2" (25.4 x 26.7 x 8.9 cm)
- 3-501 Outside Dimensions 15" x 10 1/2" x 3 1/2" (38.1 x 26.7 x 8.9 cm)
- 3-502 Outside Dimensions 20" x 10 1/2" x 3 1/2" (50.8 x 26.7 x 8.9 cm)

- 65-28 Mesh Holder, 6 3/4" (17.1 cm), 2 1/8" (5.4 cm) inside diameter of basket, securely holds small items such as micro clips, screws, burs etc., during cleaning, rinsing or sterilization

Sterilizing Aids

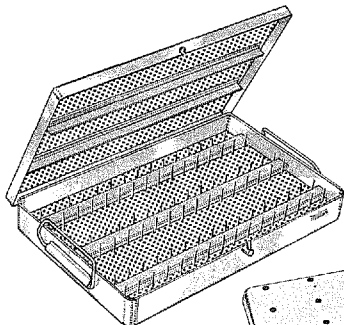

3-550 to 3-554

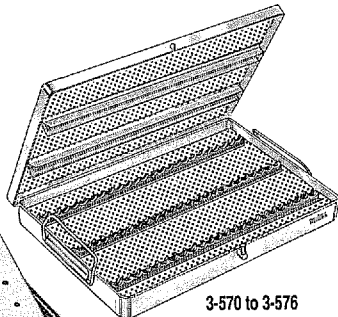

3-570 to 3-576

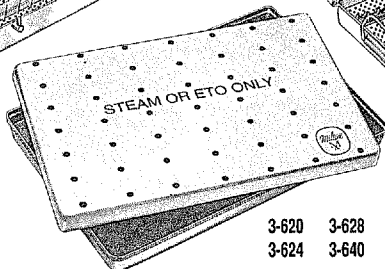

3-620 3-628
3-624 3-640

MICRO INSTRUMENT STERILIZING CASES

With handles and removable cover. Double rows of pins welded to bottom hold instruments in place. Strips of silicone rubber cushions on bottom and cover give added protection to instruments. Perforated cover and bottom assure complete heat penetration with no build-up of condensation. All edges rolled for safety. Easily operated lock holds cover securely.

- 3-550 Outside Dimensions 8" x 8 1/2" x 1 1/4" (20.3 x 21.6 x 3.2 cm)
- 3-552 Outside Dimensions 8" x 12 1/4" x 1 1/4" (20.3 x 31.1 x 3.2 cm)
- 3-554 Outside Dimensions 10 1/2" x 10" x 1 1/2" (26.7 x 25.4 x 3.8 cm)

Same features as described above, except double rows of silicone rubber cushions on bottom are adjustable to lengths of instruments. Upper silicone rubber strips hold instruments securely.

- 3-570 Outside Dimensions 8 1/2" x 8" x 1 1/4" (21.6 x 20.3 x 3.2 cm)
- 3-572 Outside Dimensions 8 1/2" x 12" x 1 1/4" (21.6 x 30.5 x 3.2 cm)
- 3-574 Outside Dimensions 10 1/2" x 10" x 1 1/2" (26.7 x 25.4 x 3.8 cm)
- 3-576 Outside Dimensions 10 1/2" x 15" x 1 1/4" (26.7 x 38.1 x 3.2 cm)

"CTS" COLOR TRAY SYSTEM

Each tray measures 11 1/8" x 7 1/4" x 1 5/16" (28.2 x 18.4 x 4.1 cm). Lightweight anodized aluminum. Tops available in red, blue and silver. All tray bottoms are silver. Each tray supplied with 2 sets of pre-cut foam which are steam and EO permeable. *Not for use with Dry Heat or Cold Sterilizing Solutions.*

- 3-620 Red
- 3-624 Blue
- 3-628 Silver
- 3-640 Pre-Cut "CTS" Foam. 6 sets of 2



Instrument Care Products

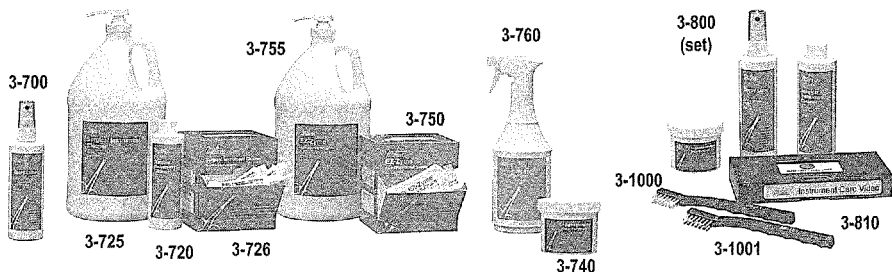

- 3-700** MILTEX Spray Lube, 8 fl. oz. (0.24 liter) bottles (case of 12). Pre-mixed non-silicon water soluble formula in pump spray bottles. Lubricates all moving parts on surgical instruments.
- 3-720** MILTEX Surgical Instrument Cleaner, 8 fl. oz. (0.24 liter) bottles (case of 12). Contents of one 8 oz. bottle makes 32 gallons of solution. Neutral pH formula for use in ultrasonic or manual cleaning of surgical instruments, glassware, plastic, metal or rubber goods.
- 3-725** MILTEX Surgical Instrument Cleaner, 1-gallon bottle (3.78 liter) (case of 4). Contents of 1-gallon container makes 512 gallons of solution.
- 3-726** MILTEX Surgical Instrument Cleaner, 1/4 fl. oz. (7.4 ml) packets (dispenser box of 80). Contents of 1-box makes 80 gallons of solution.
- 3-740** MILTEX Surgical Instrument Stain Remover, 3 oz. (85 grams) (case of 12). Special powdered formula removes stains and tarnishes, restores luster to surgical instruments, autoclaves, ultrasonic cleaners, stainless steel countertops, trays and stands.
- 3-750** MILTEX EZ-Zyme All Purpose Enzyme Cleaner, 3/4 oz. (22 ml) packets (dispenser box of 32). Contents of 1-box makes 32 gallons of solution. Neutral pH multi-enzyme liquid concentrate ideal for instrument presoak, ultrasonic cleaning, laundry presoak and evacuation system cleaner.
- 3-755** MILTEX EZ-Zyme All Purpose Enzyme Cleaner, 1-gallon bottle (3.78 liter) (case of 4). Contents of 1-gallon container makes 170 gallons of solution.
- 3-760** Instrument Prep Enzyme Foam, 24 oz. (0.71 liter) spray bottles (case of 12). Ready-to-use foaming spray for pre-cleaning of soiled instruments and scopes (rigid & flexible). Ideal for applications where instrument cleaning is not immediately available.
- 3-800** MILTEX Instrument Care System Kit includes one each of the following: Spray Lube, Surgical Instrument Cleaner, Surgical Instrument Stain Remover, Instrument Care Video, Nylon Brush and Stainless Steel Brush.
- 3-810** MILTEX Instrument Care Video, 25-minute Instructional Video designed to help practitioners and staff properly care for instruments.
- 3-1000** MILTEX Instrument Cleaning Brushes 7-1/4" (18.4cm), Nylon Bristles (Set of 3). Designed to clean instruments without scratching or harming delicate surfaces. Autoclavable.
- 3-1001** MILTEX Instrument Cleaning Brushes 7-1/4" (18.4cm), Stainless Steel Bristles (Set of 3). Designed to clean instrument serrations, rasps, files and burs. Autoclavable.

Tubing Clamps



3-2000

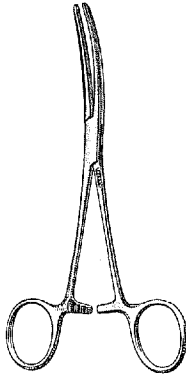

V97-584

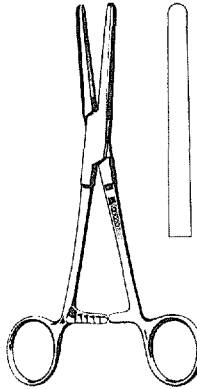

V97-590

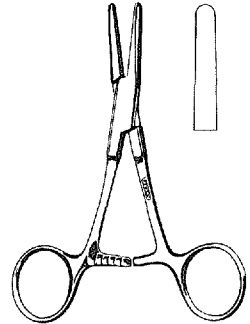

V97-588

3-2000 MILTEX Occlusion Clamp for arteriovenous cannula, 1 3/4" (4.4 cm), cross action

V97-584 ST. VINCENTS Tube Occluding Clamp 6 1/2" (16.5 cm), curved, smooth jaws

V97-590 PRESBYTERIAN HOSPITAL Tube Occluding Clamp 7" (17.8 cm), straight, smooth jaws, heavy pattern

V97-588 English Pattern Tube Occluding Clamp 4 1/2" (11.4 cm), straight, smooth jaws

V97-585 U.S. Pattern Tube Occluding Clamp 5 3/4" (14.6 cm), straight, serrated jaws, with guard

V97-591 U.S. Pattern Tube Occluding Clamp 7 1/2" (19.1 cm), straight, serrated jaws, with guard

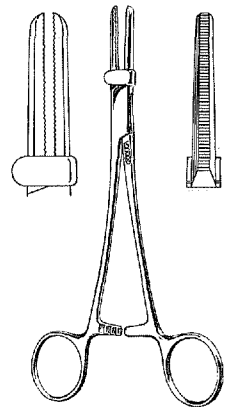

V97-585
V97-591



Scalpel Handles



4-7*
4-7R*

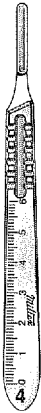

4-8*
4-8R*



4-9



4-10



4-11



4-12



4-16

- 4-7 *KNIFE HANDLE No. 3 fitting surgical blades Nos. 10 thru 15, Extra Fine
- 4-7R *Same as No. 4-7, but Economy Grade, Rustless, Nickel Plated
- 4-8 *KNIFE HANDLE No. 4 fitting surgical blades Nos. 20 thru 25, Extra Fine
- 4-8R *Same as No. 4-8, but Economy Grade, Rustless, Nickel Plated
- 4-9 KNIFE HANDLE No. 7, fitting surgical blades Nos. 10 thru 15, Extra Fine
- 4-10 KNIFE HANDLE No. 3L, for deep surgery, fitting blades Nos. 10 thru 15, Extra Fine
- 4-11 KNIFE HANDLE No. 4L, for deep surgery, fitting blades Nos. 20 thru 25, Extra Fine
- 4-12 KNIFE HANDLE No. 3LA, angled tip, for deep surgery, fitting blades Nos. 10 thru 15, Extra Fine
- 4-16 KNIFE HANDLE, No. 9, fitting blades Nos. 10 thru 15, Extra Fine

*Handles have mm and cm graduations

Scalpel Handles



4-17



4-18



4-20



4-30



4-31



4-400



4-401

- 4-17 SIEGEL Knife Handle 6" (15.2 cm) round, fitting blades Nos. 10 thru 15
- 4-18 Knife Handle Style No. 5, 5" (12.7 cm), green plastic w/stainless tip, fitting blades Nos. 10 thru 15
- 4-20 Knife Handle Style No. 6, 5 1/4" (13.3 cm), red plastic w/stainless tip, fitting blades Nos. 20 thru 25
- E-Z-OFF Reusable Plastic Knife Handles (Pat. Pend.), autoclavable, permitting quick and safe removal of blade, box of 10
- 4-30 Style No. 3, fitting blades Nos. 10 thru 15, grey color
- 4-31 Style No. 4, fitting blades Nos. 20 thru 25, blue color
- 4-400 Miniature Blade Handle w/chuck, 3 3/4" (9.5 cm), round knurled (3K type)
- 4-401 Miniature Blade Handle w/self-locking chuck, 3 3/4" (9.5 cm), round knurled (3K type)



Sterile Surgical Blades

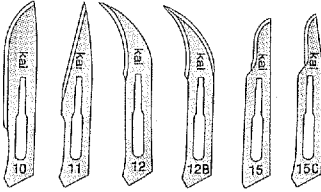

(Fits handles #s 3, 3L, 3LA, 5, 7, 9, SIEGEL)

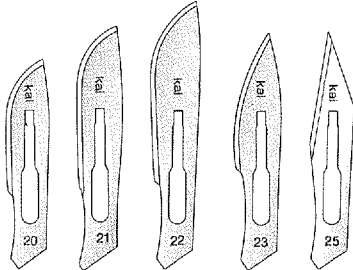

(Fits handles #s 4, 4L, 6)



4-110 to 4-125

MILTEX SURGICAL BLADES — Made by Kai

Individually sealed in Foil Peel Packs.
Packed 100 blades to a Dispenser Box.
Sterilized by Gamma Radiation 2.5M Rads.

CARBON STEEL — STERILE

	Blade Size
4-110	10
4-111	11
4-112	12
4-112B	12B
4-115	15
4-115C	15C
4-120	20
4-121	21
4-122	22
4-123	23
4-125	25
4-100	

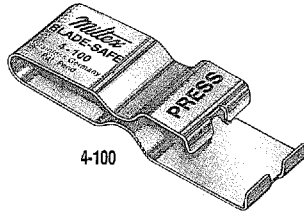

4-100

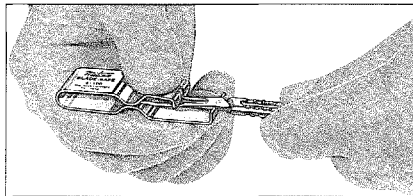

BLADE SAFE Surgical Blade Remover, will remove blades easily and safely from any style surgical handle.

Sterile Surgical Blades

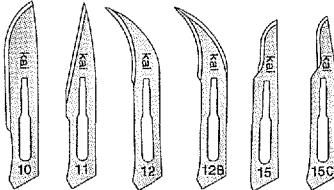

(Fits handles #s 3, 3L, 3LA, 5, 7, 9, SIEGEL)

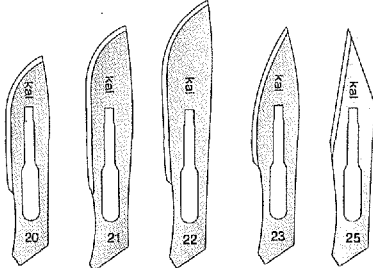

(Fits handles #s 4, 4L, 6)



4-310 to 4-325

MILTEX SURGICAL BLADES — Made by Kai

Individually sealed in Foil Peel Packs.
Packed 100 blades to a Dispenser Box.
Sterilized by Gamma Radiation 2.5M Rads.

STAINLESS STEEL — STERILE

	Blade Size
4-310	10
4-311	11
4-312	12
4-312B	12B
4-315	15
4-315C	15C
4-320	20
4-321	21
4-322	22
4-323	23
4-325	25



Sterile Disposable Scalpels

Miltex single-use Scalpels are pre-assembled: Stainless steel surgical blades mounted on plastic handles with fluted finger-grips. The scalpel blade is safely protected by a new type easy pull-off protector.

Each sterile scalpel is sealed in a peel-apart see-through package. 10 scalpels are packaged in a handy dispenser box for convenient use. Scalpels are supplied sterile - ready-to-use.

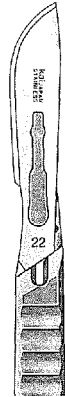
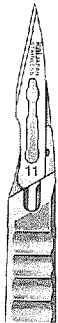
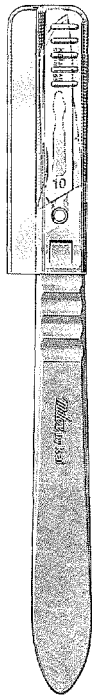
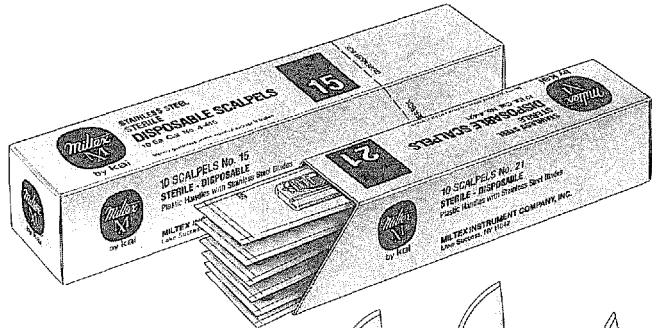

MILTEX DISPOSABLE SCALPELS — Made by Kai

Packed 10 Scalpels to a Dispenser Box.
Sterilized by EO.

STAINLESS STEEL — STERILE

	Blade Size
4-410	10
4-411	11
4-412	12
4-415	15
4-420	20
4-421	21
4-422	22
4-423	23

Operating Scissors

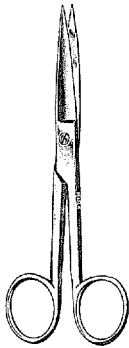

5-2 to 5-8

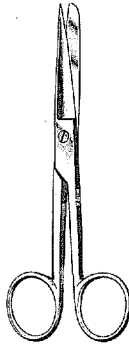

5-12 to 5-19

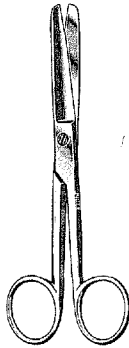

5-22 to 5-28

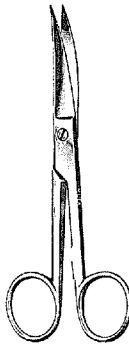

5-32 to 5-38

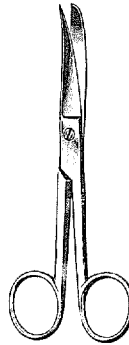

5-42 to 5-49

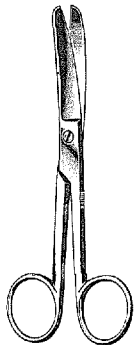

5-52 to 5-58

STANDARD PATTERN OPERATING SCISSORS

Straight		Curved		Straight		Curved	
Sharp-sharp points				Sharp-blunt points			
5-2	4½" (11.4 cm)	5-32		5-12	4½" (11.4 cm)	5-42	
5-4	5" (12.7 cm)	5-34		5-14	5" (12.7 cm)	5-44	
5-6	5½" (14 cm)	5-36		5-16	5½" (14 cm)	5-46	
5-7	6" (15.2 cm)	5-37		5-17	6" (15.2 cm)	—	
5-8	6½" (16.5 cm)	5-38		5-18	6½" (16.5 cm)	5-48	
				5-19	7½" (19.1 cm)	5-49	
				Curved			
				Blunt-blunt points			
		5-22	4½" (11.4 cm)	5-52			
		5-24	5" (12.7 cm)	5-54			
		5-26	5½" (14 cm)	5-56			
		5-27	6" (15.2 cm)	—			
		5-28	6½" (16.5 cm)	5-58			



Operating Scissors

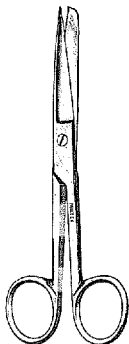

5-70 to 5-73

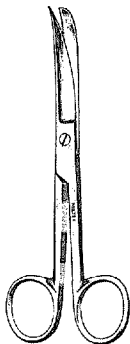

5-74 to 5-77

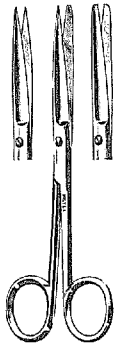

5-60 to 5-62
5-80 to 5-84

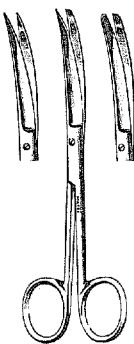

5-63 to 5-65
5-86 to 5-90

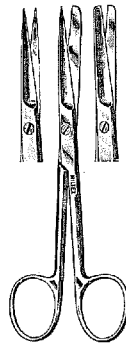

5-100 to 5-104



5-106 to 5-108

SERRATEX OPERATING SCISSORS

Standard Pattern Operating Scissors. One blade with fine serrations reduces tissue slippage.

Straight		Curved
5-70	5½" (14 cm) Sharp-sharp points	5-74
5-72	5½" (14 cm) Sharp-blunt points	5-76
5-73	5½" (14 cm) Blunt-blunt points	5-77

NOTE: Serrated blades are available on all types of scissors, on special request.

LIGHTWEIGHT OPERATING SCISSORS

Delicate pattern designed for pediatric, vascular and other delicate procedures.

Straight		Curved
Sharp-sharp points		
5-60	5" (12.7 cm)	5-63
5-80	5½" (14 cm)	5-86
Sharp-blunt points		
5-61	5" (12.7 cm)	5-64
5-82	5½" (14 cm)	5-88
Blunt-blunt points		
5-62	5" (12.7 cm)	5-65
5-84	5½" (14 cm)	5-90

DEAVER SCISSORS 5½" (14 cm)

5-100	Straight, sharp-sharp points	5-106	Curved, sharp-sharp points
5-102	Straight, sharp-blunt points	5-108	Curved, sharp-blunt points
5-104	Straight, blunt-blunt points		

Operating Scissors



5-112

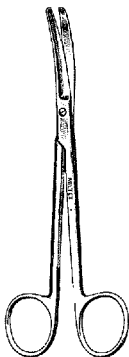

5-114

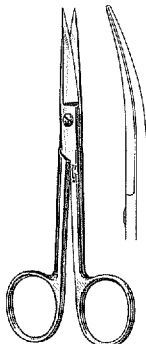

5-115
5-116

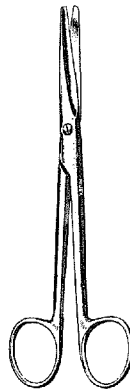

5-120
5-124

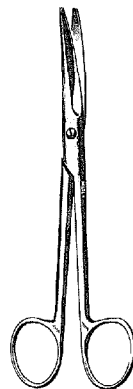

5-122
5-126

- 5-112 MIXTER Scissors 6¼" (15.9 cm), straight, blunt points
- 5-114 MIXTER Scissors 6¼" (15.9 cm), curved, blunt points
- 5-115 MAYO Operating Scissors 5½" (14 cm), straight, heavy pattern, sharp points
- 5-116 MAYO Operating Scissors 5½" (14 cm), curved, heavy pattern, sharp points
- 5-120 MAYO Dissecting Scissors 5½" (14 cm), straight, standard beveled blades
- 5-122 MAYO Dissecting Scissors 5½" (14 cm), curved, standard beveled blades
- 5-124 MAYO Dissecting Scissors 6¾" (17.1 cm), straight, standard beveled blades
- 5-126 MAYO Dissecting Scissors 6¾" (17.1 cm), curved, standard beveled blades
- 5-128 MAYO Dissecting Scissors 9" (22.9 cm), straight, standard beveled blades
- 5-130 MAYO Dissecting Scissors 9" (22.9 cm), curved, standard beveled blades

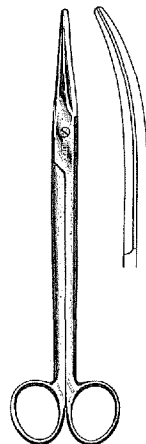

5-128
5-130

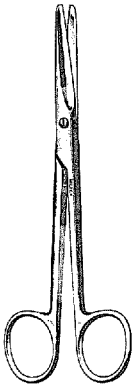

5-132

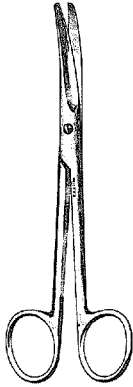

5-134

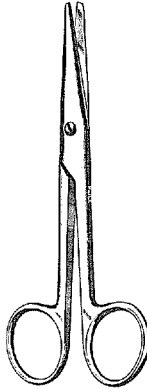

5-136
5-140

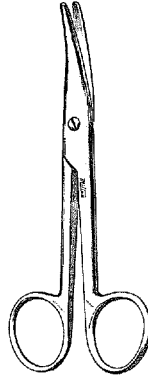

5-138
5-142

- 5-132 SERRATEX-MAYO Dissecting Scissors 6¾" (17.1 cm), straight, one fine serrated blade
- 5-134 SERRATEX-MAYO Dissecting Scissors 6¾" (17.1 cm), curved, one fine serrated blade
- 5-136 MAYO Dissecting Scissors 5½" (14 cm), straight, rounded blades
- 5-138 MAYO Dissecting Scissors 5½" (14 cm), curved, rounded blades
- 5-140 MAYO Dissecting Scissors 6¾" (17.1 cm), straight, rounded blades
- 5-142 MAYO Dissecting Scissors 6¾" (17.1 cm), curved, rounded blades

Operating Scissors

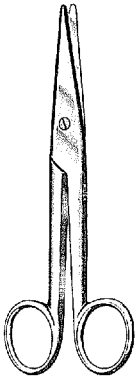

5-144

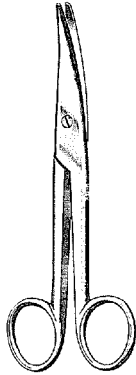

5-146

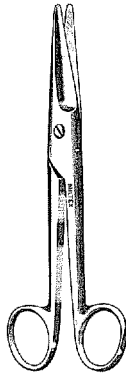

5-148

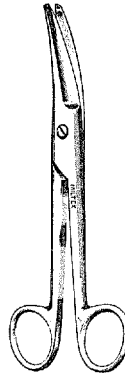

5-150

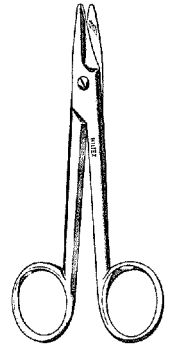

5-152
5-154

- 5-144 MAYO-NOBLE Dissecting Scissors 6½" (16.5 cm), straight, rounded blades
- 5-146 MAYO-NOBLE Dissecting Scissors 6½" (16.5 cm), curved, rounded blades
- 5-148 MAYO-NOBLE Dissecting Scissors 6½" (16.5 cm), straight, beveled blades
- 5-150 MAYO-NOBLE Dissecting Scissors 6½" (16.5 cm), curved, beveled blades
- 5-152 SISTRUNK Scissors 5½" (14 cm), straight
- 5-154 SISTRUNK Scissors 5½" (14 cm), slightly curved

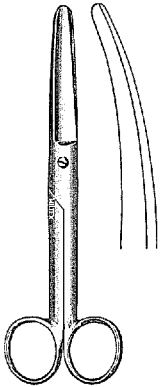

5-160
5-162

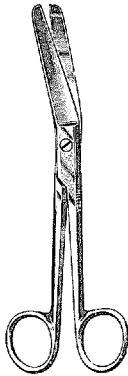

5-166



5-172 to 5-178

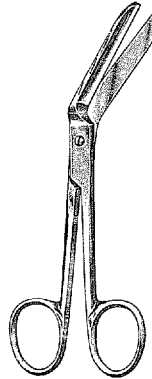

30-2190
30-2195

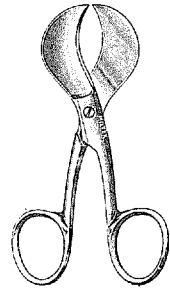

30-2575

- 5-160 DOYEN Abdominal Scissors 7" (17.8 cm), straight
- 5-162 DOYEN Abdominal Scissors 7" (17.8 cm), curved
- 5-166 FERGUSON Abdominal Scissors 7" (17.8 cm), angled on flat
- 5-172 REYNOLDS Dissecting Scissors 6" (15.2 cm), curved, tenotomy type dissecting tips
- 5-174 REYNOLDS Dissecting Scissors 6" (15.2 cm), curved, tenotomy type dissecting tips, one serrated blade
- 5-176 REYNOLDS Dissecting Scissors 7" (17.8 cm), curved, tenotomy type dissecting tips
- 5-178 REYNOLDS Dissecting Scissors 7" (17.8 cm), curved, tenotomy type dissecting tips, one serrated blade
- 30-2190 BRAUN Episiotomy Scissors 5½" (14 cm), angled to side, guarded lower blade
- 30-2195 BRAUN Episiotomy Scissors 8½" (21.6 cm), angled to side, guarded lower blade
- 30-2575 Umbilical Scissors 4½" (10.5 cm), American Pattern
- 30-2580 BUSCH Scissors 6½" (16.5 cm), curved on side

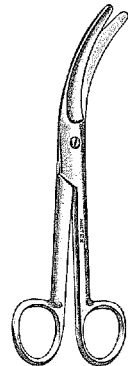

30-2580

Operating Scissors

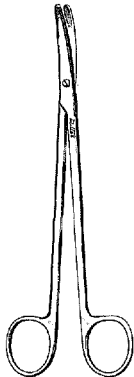

5-180
5-182
5-184

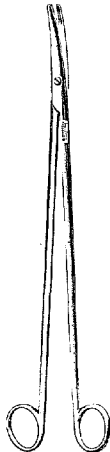

5-188
5-192
5-196



5-284
5-286
5-288

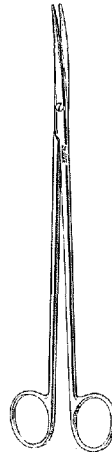

5-185
5-189
5-193

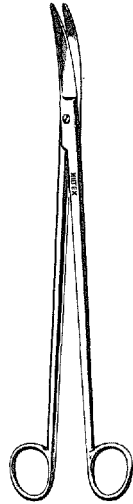

5-200
5-202

METZENBAUM SCISSORS – STANDARD PATTERN

Straight	Length	Curved
5-179	5½" (14 cm) (Lahey)	5-180
5-181	7" (17.8 cm)	5-182
—	8" (20.3 cm)	5-184
5-186	9" (22.9 cm) (Nelson)	5-188
5-190	11" (27.9 cm) (Nelson)	5-192
5-194	14½" (36.8 cm) (Nelson)	5-196

METZENBAUM SCISSORS – DELICATE PATTERN

Straight	Length	Curved
5-283	5" (12.7 cm)	5-284
—	6" (15.2 cm)	5-286
—	7" (17.8 cm)	5-288
5-183	8" (20.3 cm)	5-185
5-187	9" (22.9 cm)	5-189
—	11" (27.9 cm)	5-193

5-200 HARRINGTON Scissors 11½" (29.2 cm), straight

5-202 HARRINGTON Scissors 11½" (29.2 cm), curved



Operating Scissors

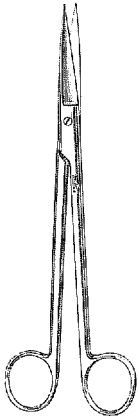

5-220
5-222
5-224

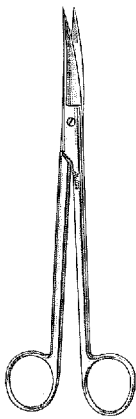

5-226
5-228
5-230

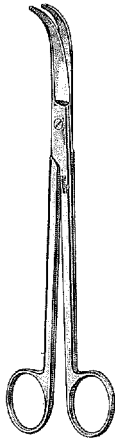

5-243

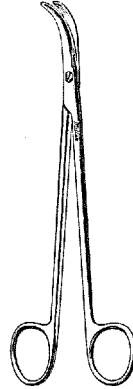

5-244
5-245

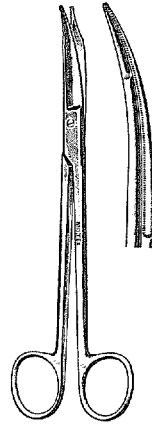

27-1000

- 5-220 SIMS Scissors 8" (20.3 cm), straight, sharp-sharp points
- 5-222 SIMS Scissors 8" (20.3 cm), straight, sharp-blunt points
- 5-224 SIMS Scissors 8" (20.3 cm), straight, blunt-blunt points
- 5-226 SIMS Scissors 8" (20.3 cm), curved, sharp-sharp points
- 5-228 SIMS Scissors 8" (20.3 cm), curved, sharp-blunt points
- 5-230 SIMS Scissors 8" (20.3 cm), curved, blunt-blunt points
- 5-243 JORGENSON Scissors 9" (22.9 cm), strongly curved blades
- 5-244 THOREK Scissors 7 1/4" (18.4 cm), full curve
- 5-245 THOREK Scissors 10" (25.4 cm), full curve
- 27-1000 MARTIN Cartilage Scissors 8" (20.3 cm), serrated non-slip cutting edges
- 30-2605 DUBOIS Scissors 10 1/2" (26.7 cm), curved, extra heavy pattern, blunt points

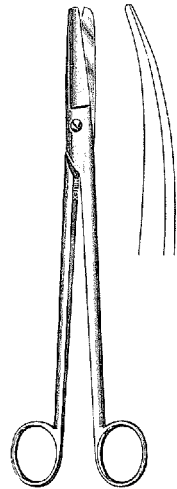

30-2605

Operating Scissors

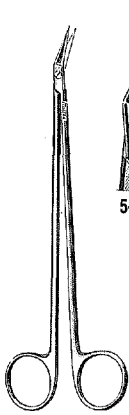

5-246



5-247



5-248

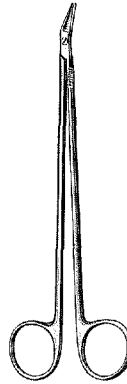

5-249A



5-249B

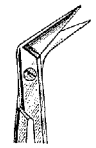

5-249C

- 5-246 POTTSMITH Scissors 7½" (19.1 cm), angled on side 25°, 20 mm blades
- 5-247 POTTSMITH Scissors 7½" (19.1 cm), angled on side 45°, 20 mm blades
- 5-248 POTTSMITH Scissors 7½" (19.1 cm), angled on side 60°, 20 mm blades
- 5-249A POTTSMITH Scissors 7" (17.8 cm), delicate, angled on side 25°, 13 mm blades
- 5-249B POTTSMITH Scissors 7" (17.8 cm), delicate, angled on side 45°, 13 mm blades
- 5-249C POTTSMITH Scissors 7" (17.8 cm), delicate, angled on side 60°, 13 mm blades

- 25-1240B DeBAKEY-POTTSMITH Scissors 6¾" (17.1 cm), dull tips, angled on side 45°
- 25-1240C DeBAKEY-POTTSMITH Scissors 6¾" (17.1 cm), dull tips, angled on side 60°

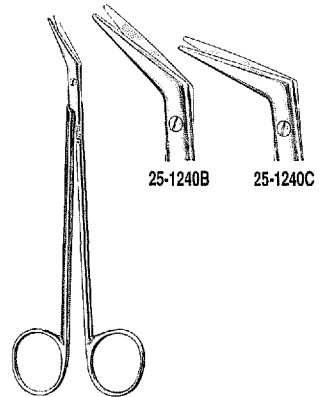

25-1240B

25-1240C



Operating Scissors

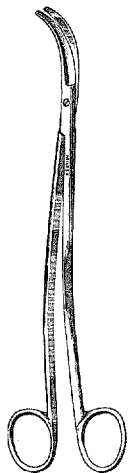

25-1280

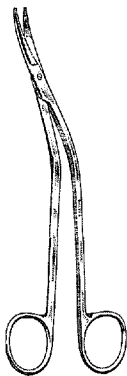

28-240



5-250
5D-251



5-252
5D-253



5-254
5D-255

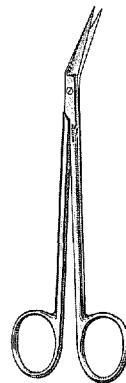

5D-328

- 25-1280** SATINSKY Scissors 10" (25.4 cm), S-curved
- 28-240** MILLER Rectal Scissors 6 $\frac{3}{4}$ " (17.1 cm), bayonet shape, delicate serrated blades with blunt points
- 5-250** KELLY Fistula Scissors 6 $\frac{1}{4}$ " (15.9 cm), sharp points, straight
- 5D-251** KELLY Fistula Scissors 6 $\frac{1}{4}$ " (15.9 cm), sharp points, straight, with one serrated blade
- 5-252** KELLY Fistula Scissors 6 $\frac{1}{4}$ " (15.9 cm), sharp points, curved
- 5D-253** KELLY Fistula Scissors 6 $\frac{1}{4}$ " (15.9 cm), sharp points, curved, with one serrated blade
- 5-254** KELLY Fistula Scissors 6 $\frac{1}{4}$ " (15.9 cm), sharp points, angled on side
- 5D-255** KELLY Fistula Scissors 6 $\frac{1}{4}$ " (15.9 cm), sharp points, angular, with one serrated blade
- 5D-328** LOCKLIN Scissors 6 $\frac{1}{4}$ " (15.9 cm), angled on side 25°, with one serrated blade
- 5D-329** LOCKLIN Scissors 6 $\frac{1}{4}$ " (15.9 cm), curved shanks, angled on side 25°, with one serrated blade

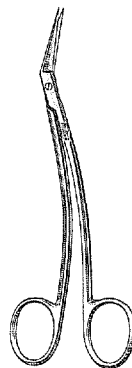

5D-329

Operating Scissors

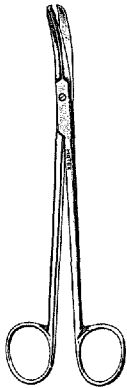

5-256

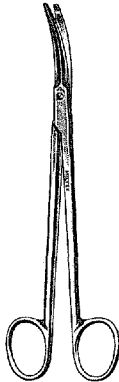

22-962

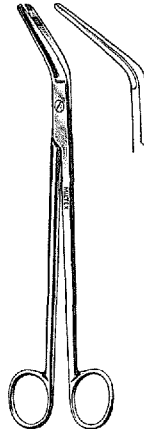

5-260

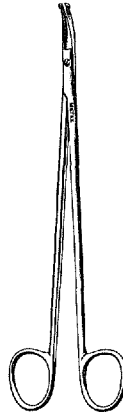

5-262

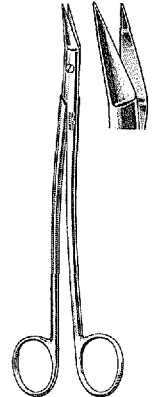

5-264

5-256 BOETTCHER Dissecting Scissors 7¼" (18.4 cm), double edged, curved

22-962 LILLY Dissecting Scissors 7½" (19.1 cm), strong curve

5-260 SWEET Scissors 8½" (21.6 cm), angled on flat

5-262 STRULLY Dissecting Scissors 8" (20.3 cm), slightly curved blades with probe tips

5-264 DEAN Dissecting Scissors 6¾" (17.1 cm), blades angled on flat, one serrated blade

5-265 KAHN Dissecting Scissors 5½" (14 cm), straight

5-266 KAHN Dissecting Scissors 5½" (14 cm), curved

5-267 KAHN Dissecting Scissors 7" (17.8 cm), straight

5-268 KAHN Dissecting Scissors 7" (17.8 cm), curved

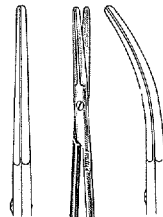

5-265

5-266

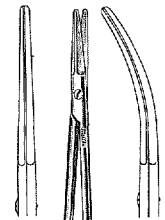

5-267

5-268

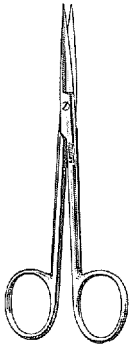

5-270
5-271

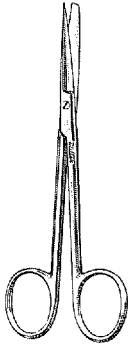

5-272
5-273

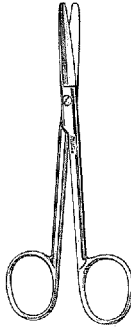

5-274
5-275

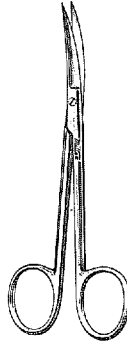

5-276
5-277

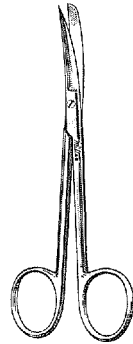

5-278
5-279

PLASTIC SURGERY SCISSORS 4 3/4" (12.1cm)

Straight

- 5-270 Sharp-sharp points
- 5-271 Sharp-sharp points, serrated blade
- 5-272 Sharp-blunt points
- 5-273 Sharp-blunt points, serrated blade
- 5-274 Blunt-blunt points
- 5-275 Blunt-blunt points, serrated blade

Curved

- 5-276
- 5-277
- 5-278
- 5-279
- 5-280
- 5-281

Angled on side

- 5-282 Sharp-sharp points
- 5-282A Sharp-sharp points, serrated blade

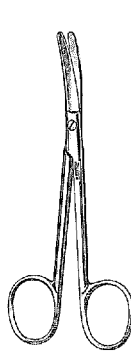

5-280
5-281

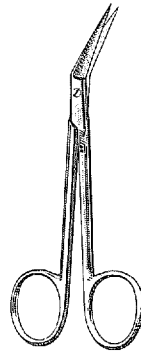

5-282
5-282A

Operating Scissors

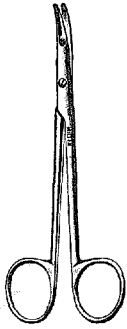

5-290
5-291

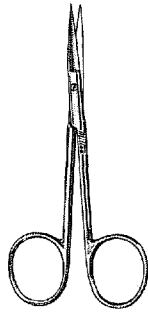

5-300

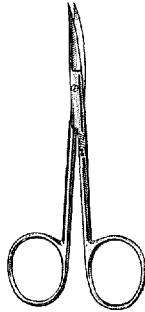

5-302

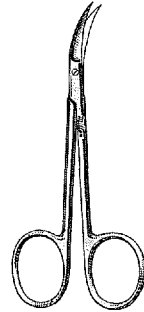

5D-303

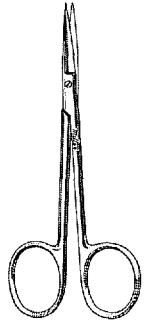

5-304

- 5-290 RAGNELL Dissecting Scissors 5" (12.7 cm), flat tip, curved
- 5-291 RAGNELL Dissecting Scissors 7" (17.8 cm), flat tip, curved
- 5-300 Iris Scissors 4" (10.2 cm), straight
- 5-302 Iris Scissors 4" (10.2 cm), curved
- 5D-303 Iris Scissors 4½" (11.4 cm), curved sideways
- 5-304 Iris Scissors 4½" (11.4 cm), straight
- 5-306 Iris Scissors 4½" (11.4 cm), curved
- 5-308 Iris Scissors 4½" (11.4 cm), angled on side

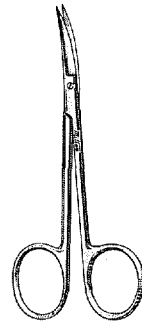

5-306

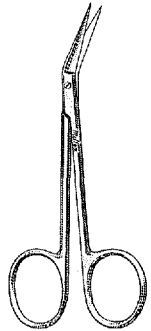

5-308



Operating Scissors



18-1392
18-1394

18-1396

18-1398

18-1404

18-1405

18-1415*
18-1416*

- 18-1392 BONN Miniature Iris Scissors 3½" (8.9 cm), with 15 mm blades, straight
- 18-1394 BONN Miniature Iris Scissors 3½" (8.9 cm), with 15 mm blades, curved
- 18-1396 Iris Scissors 3½" (8.9 cm), with 20 mm blades, straight, delicate
- 18-1398 Iris Scissors 3½" (8.9 cm), with 20 mm blades, curved, delicate
- 18-1404 MILTEX Iris Scissors 4" (10.2 cm), straight, heavy pattern
- 18-1405 MILTEX Iris Scissors 4" (10.2 cm), curved, heavy pattern
- 18-1415* Iris Scissors 4" (10.2 cm), straight, standard pattern, ribbon type
- 18-1416* Iris Scissors 4" (10.2 cm), curved, standard pattern, ribbon type
- 18-1417* Iris Scissors 3¾" (9.5 cm), straight, miniature pattern with 14 mm blades, ribbon type
- 18-1418* Iris Scissors 3¾" (9.5 cm), curved, miniature pattern with 14 mm blades, ribbon type
- 18-1419* Utility Scissors 3¾" (9.5 cm), curved blunt blades, 15 mm long, ribbon type

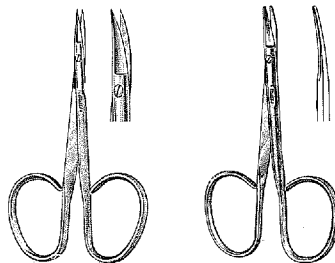

18-1417*
18-1418*

18-1419*

*Ribbon Type Scissors have extra large finger rings; shanks and rings have satin finish; blades are highly polished

Operating Scissors

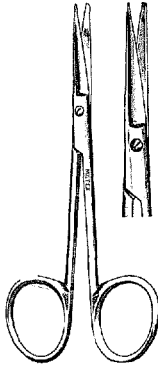

18-1420
18-1422

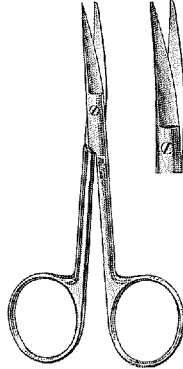

18-1426
18-1428

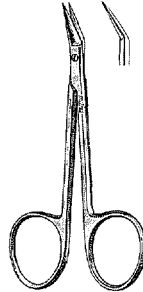

18-1440

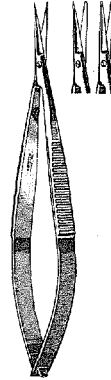

18-1510
18-1512
18-1514



18-1516

- 18-1420 KNAPP Iris Scissors 4" (10.2 cm), straight, sharp-blunt points
- 18-1422 KNAPP Iris Scissors 4" (10.2 cm), straight, blunt-blunt points
- 18-1426 KNAPP Iris Scissors 4" (10.2 cm), curved, sharp-blunt points
- 18-1428 KNAPP Iris Scissors 4" (10.2 cm), curved, blunt-blunt points
- 18-1440 WILMER Conjunctival and Utility Scissors 4" (10.2 cm), angled on flat

- 18-1510 NOYES Iris Scissors 4½" (11.4 cm), straight, sharp-sharp points
- 18-1512 NOYES Iris Scissors 4½" (11.4 cm), straight, sharp-blunt points
- 18-1514 NOYES Iris Scissors 4½" (11.4 cm), straight, blunt-blunt points
- 18-1516 NOYES Iris Scissors 4½" (11.4 cm), curved, sharp-sharp points

- 18-1520 BARRAQUER Iris Scissors 2¼" (5.7cm), angled 7 mm blades, sharp points
- 18-1521 BARRAQUER Iris Scissors 2¼" (5.7cm), angled 7 mm blades, blunt points

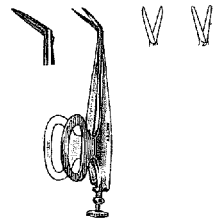

18-1520
18-1521



Operating Scissors

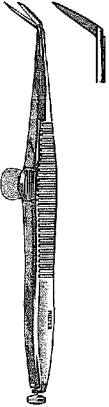

18-1524
18-1526

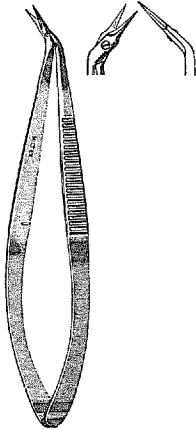

18-1550
18-1552

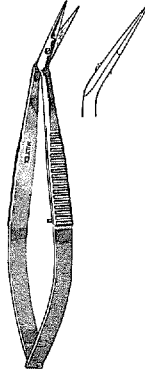

18-1554

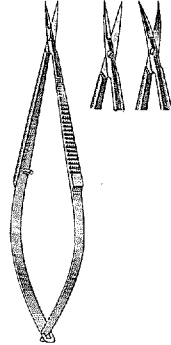

18-1618
18-1619

- 18-1524 DeWECKER Iris Scissors 4 1/4" (10.8 cm), angled 7 mm blades, sharp-sharp points
- 18-1526 DeWECKER Iris Scissors 4 1/4" (10.8 cm), angled 7 mm blades, sharp-blunt points

- 18-1550 McCLURE Iris Scissors 3 3/4" (9.5 cm), angled over edge, 4 mm blades with very delicate sharp points

- 18-1552 McCLURE Iris Scissors 3 3/4" (9.5 cm), angled on flat, 4 mm blades with very delicate sharp points

- 18-1554 McCLURE Iris Scissors 4" (10.2 cm), angled on flat, regular 10 mm blades with sharp points

- 18-1618 Micro Iris Scissors 4" (10.2 cm), straight, sharp points
- 18-1619 Micro Iris Scissors 4" (10.2 cm), curved, sharp points

- 18-1625 McPHERSON-VANNAS Micro Iris Scissors 3 1/4" (8.3 cm), straight, sharp points
- 18-1626 McPHERSON-VANNAS Micro Iris Scissors 3 1/4" (8.3 cm), curved, sharp points

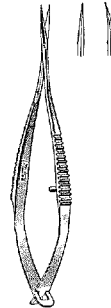

18-1625
18-1626

Operating Scissors

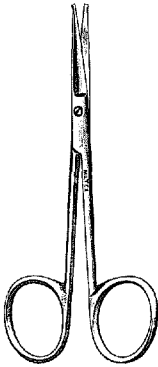

18-1430

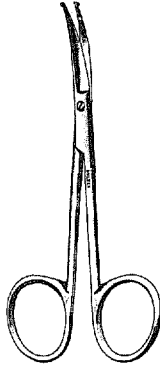

18-1432

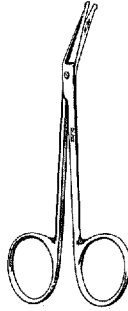

5-310

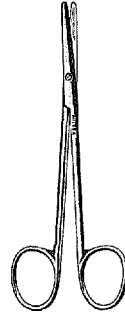

5-312

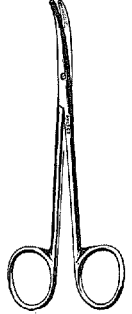

5-314

- 18-1430 Eye Scissors with probe points 4" (10.2 cm), straight
- 18-1432 Eye Scissors with probe points 4" (10.2 cm), curved
- 5-310 Eye Scissors with probe points 4½" (11.4 cm), angled on side
- 5-312 Strabismus Scissors 4" (10.2 cm), straight
- 5-314 Strabismus Scissors 4" (10.2 cm), curved
- 18-1453* Strabismus Scissors 4¼" (10.8 cm), curved, ribbon type
- 18-1454* Strabismus Scissors 4¼" (10.8 cm), curved, ribbon type

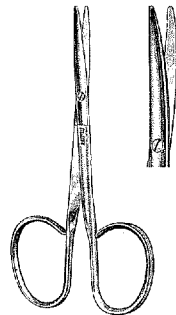

18-1453*
18-1454*

*Ribbon Type Scissors have extra large finger rings; shanks and rings have satin finish; blades are highly polished



Operating Scissors

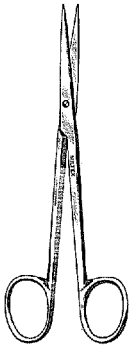

5-316



5-318

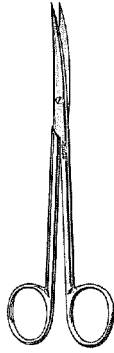

5D-326

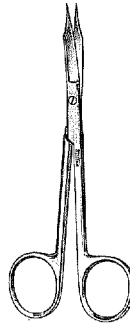

5-320

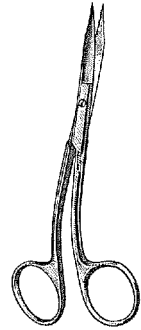

5D-322

- 5-316 BROPHY Scissors 5½" (14 cm), straight, sharp points
- 5-318 BROPHY Scissors 5½" (14 cm), curved, sharp points
- 5D-326 BROPHY Scissors 5½" (14 cm), curved, one serrated blade
- 5-320 GOLDMAN-FOX Wound Debridement Scissors 5" (12.7 cm), curved fine tips with one serrated blade
- 5D-322 GOLDMAN-FOX Wound Debridement Scissors 5" (12.7 cm), curved, one serrated blade, angled shanks
- 5D-324 LA GRANGE Scissors 4¼" (10.8 cm), curved, one serrated blade, angled shanks
- 21-539 KLEINERT-KUTZ Tenotomy Scissors 4¾" (12.4 cm), curved, rounded dissecting blades

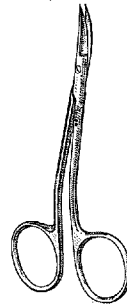

5D-324

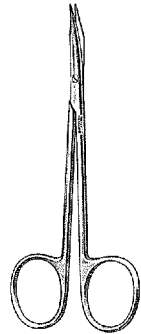

21-539

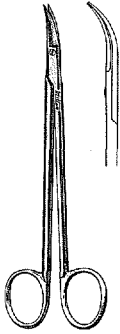

21-558
21D-559

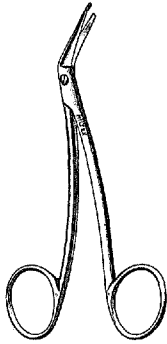

21-560



21-600

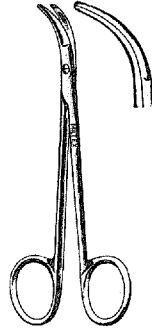

21-602

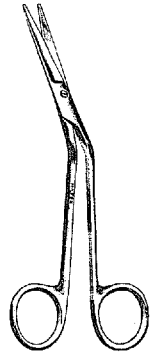

21-604

- 21-558 QUIMBY Scissors 5" (12.7 cm), blades 15 mm, strongly curved and pointed
- 21D-559 QUIMBY Scissors 5" (12.7 cm), blades 15 mm, strongly curved and pointed, one serrated blade
- 21-560 TAYLOR Dural Scissors 5½" (14 cm), with probe tip
- 21-600 FOMON Saber-Back 5" (12.7 cm), slightly curved blades with semi-sharp outer edges used for dissection
- 21-602 FOMON Lower Lateral Scissors 5" (12.7 cm), strong curve, dissecting blades
- 21-604 FOMON Dorsal Scissors 5½" (14 cm), light pattern, angular shanks
- 21-605 MILTEX Saber-Back Rhytidectomy Scissors 6½" (16.5 cm), curved with semi-sharp outer edges used for dissection

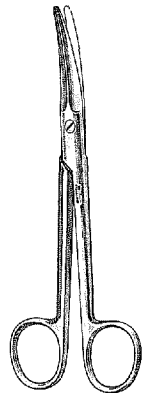

21-605

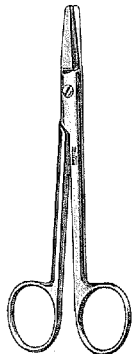

21-606

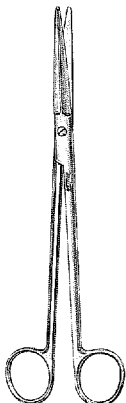

21-607

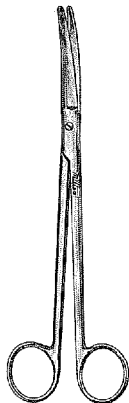

21-608

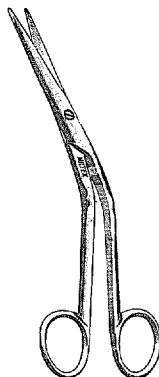

21-610

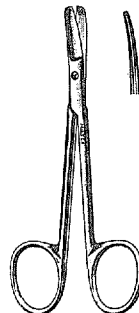

21-612

- 21-606** CASTANARES Facelift Scissors 6¼" (15.9 cm), straight, short strong blades
- 21-607** GORNEY Facelift Scissors 7¾" (19.7 cm), straight, one serrated blade
- 21-608** GORNEY Facelift Scissors 7¾" (19.7 cm), slightly curved, one serrated blade
- 21-610** COTTLE Dorsal Scissors 6½" (16.5 cm), heavy pattern with rounded blades, angular shanks
- 21-612** COTTLE Bulldog Nasal Scissors 4½" (11.4 cm), slightly curved blunt blades

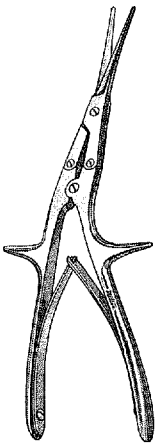

21-621

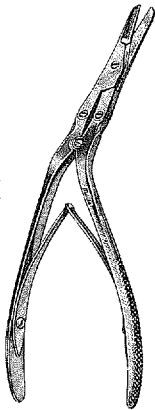

21-622

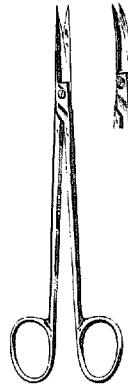

21-630
21-632

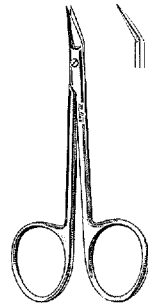

33-240

- 21-621 GORNEY Septal Scissors 7¾" (19.7 cm), double action, angled handle, serrated blades with 1¼" (4.4 cm) cut
- 21-622 CAPLAN Nasal Bone Scissors 8" (20.3 cm), double action, serrated blades
- 21-630 JOSEPH Nasal Scissors 5¾" (14.6 cm), straight, sharp points
- 21-632 JOSEPH Nasal Scissors 5¾" (14.6 cm), curved, sharp points
- 33-240 BIRO Dermal Naevus Scissors 4" (10.2 cm), angled on flat, with sharp outside edges
- 33-242 MILTEX Undermining Scissors 4½" (11.4 cm), curved blades, with flat pointed tip

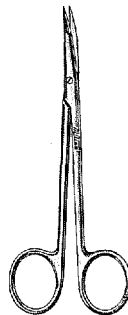

33-242

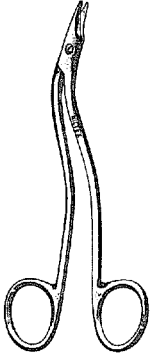

9-96

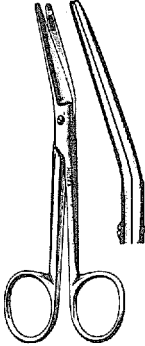

9-98

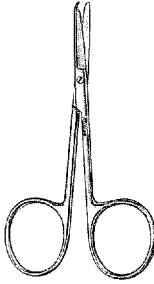

9-100

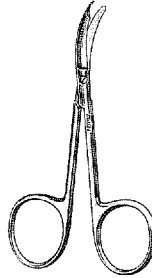

9-101

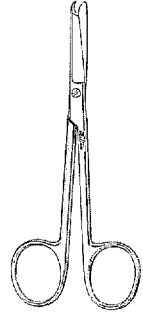

9-102

- 9-96 HEATH Suture Scissors 6¼" (15.9 cm), serrated blade
- 9-98 NEWS Suture Scissors 5½" (14 cm), angled on flat
- 9-100 SPENCER Stitch Scissors 3½" (8.9 cm), delicate
- 9-101 SHORTBENT Stitch Scissors 3½" (8.9 cm), curved, delicate
- 9-102 LITTAUER JR. Stitch Scissors 4½" (11.4 cm), light pattern
- 9-103 NORTHBENT Stitch Scissors 4¾" (12.1 cm), curved, light pattern
- 9-104 LITTAUER Stitch Scissors 5½" (14 cm), standard pattern

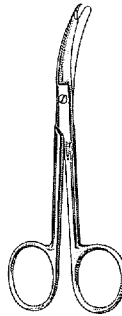

9-103

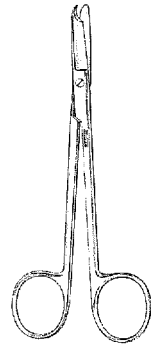

9-104

Operating Scissors

Milrex
M

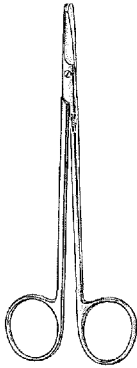

9-106

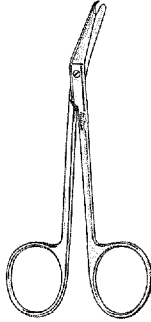

9-108

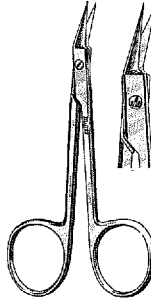

9-110

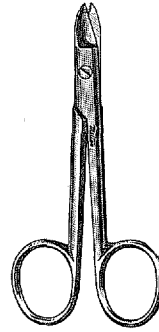

9-120
9D-121

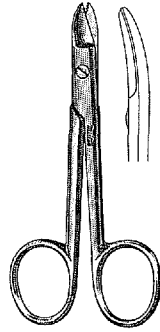

9-122
9D-123

- 9-106 LONG Oral Surgery Stitch Scissors 6" (15.2 cm)
- 9-108 MILTEX Stitch Scissors 4½" (11.4 cm), angled, delicate
- 9-110 O'BRIEN Stitch Scissors 3¾" (9.5 cm), angled, sharp points

WIRE CUTTING SCISSORS 4¾" (12.1 cm)

- 9-120 Straight, one serrated blade
- 9D-121 Straight
- 9-122 Curved, one serrated blade
- 9D-123 Curved
- 9-124 Angled to side, one serrated blade

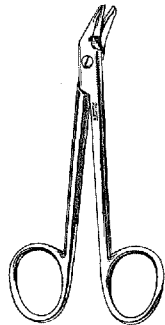

9-124



Operating Scissors

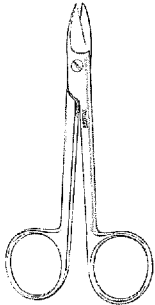

9D-132
9D-133

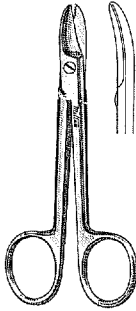

9D-134
9D-135



18-1486

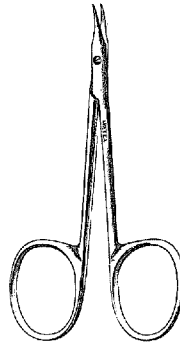

18-1652

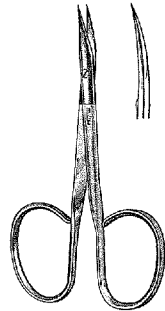

18-1653*

WIRE CUTTING SCISSORS 4¼" (10.8 cm)

- 9D-132 Straight, one serrated blade
- 9D-133 Straight
- 9D-134 Curved, one serrated blade
- 9D-135 Curved

18-1486 WESTCOTT Stitch Scissors 4½" (11.4 cm), curved, sharp points

18-1652 Eye Suture (GRADLE) Scissors 3¾" (9.5 cm), slightly curved, sharp points

18-1653* Eye Suture Scissors 4" (10.2 cm), slightly curved, sharp points, ribbon type

21-536 LITTLER Suture Carrying Scissors 4⅝" (11.8 cm), with suture hole in blades, curved

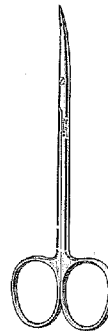

21-536

* Ribbon Type Scissors have extra large finger rings; shanks and rings have satin finish; blades are highly polished



17-115
17-120
17-215



17-115 17-120
17-215



17-500

PENCIL-TYPE MICRO SCISSORS

7/8" (18.4 cm) overall length; extremely delicate working ends

- 17-115 Scissors, 4 mm long blades, straight shaft
- 17-120 Scissors, 8 mm long blades, straight shaft
- 17-215 Scissors, 4 mm long blades, angled shaft

- 17-500 MILTEX Micro Dissecting Scissors 5/8" (14.6 cm), double action, sharp points, spring handle

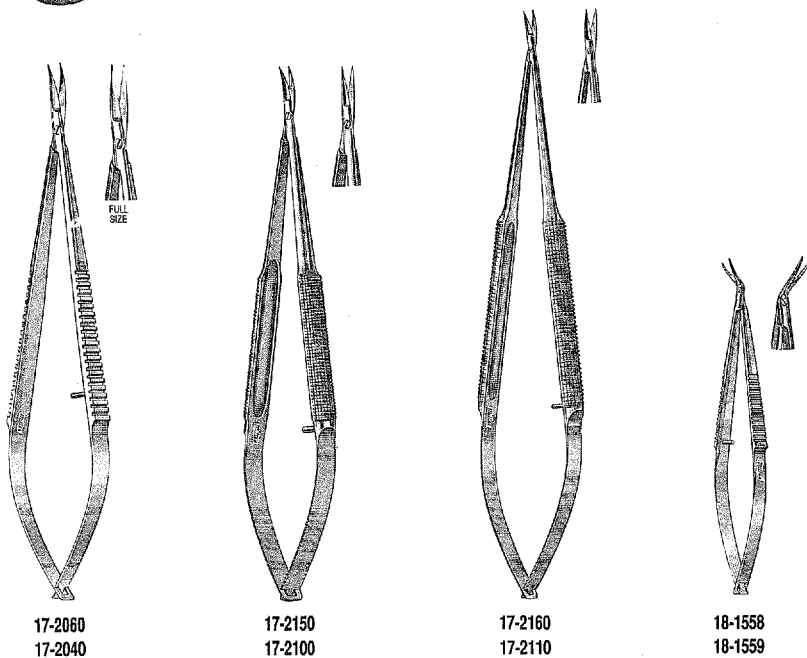

MILTEX MICRO SURGERY SCISSORS, Sharp points

- 17-2060 6" (15.2 cm) straight, 8 mm blades, flat handles
- 17-2040 6" (15.2 cm) curved, 8 mm blades, flat handles
- 17-2150 6" (15.2 cm) straight, 6 mm blades, round handles
- 17-2100 6" (15.2 cm) curved, 6 mm blades, round handles
- 17-2160 7½" (18.1 cm) straight, 6 mm blades, round handles
- 17-2110 7½" (18.1 cm) curved, 6 mm blades, round handles

- 18-1558 CASTROVIEJO Corneal Scissors 4" (10.2 cm), right, sub-miniature for micro surgery, 6 mm blades
- 18-1559 CASTROVIEJO Corneal Scissors 4" (10.2 cm), left, sub-miniature for micro surgery, 6 mm blades

Operating Scissors

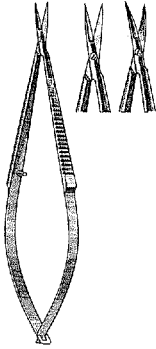

18-1618
18-1619



18-1625
18-1626

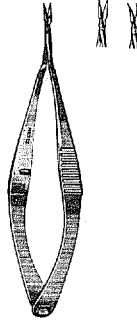

18-1630
18-1631



18-1633
18-1634

- 18-1618** Micro Iris Scissors 4" (10.2 cm), straight, sharp points
- 18-1619** Micro Iris Scissors 4" (10.2 cm), curved, sharp points
- 18-1625** McPHERSON-VANNAS Micro Iris Scissors 3/4" (8.3 cm), straight, sharp points
- 18-1626** McPHERSON-VANNAS Micro Iris Scissors 3/4" (8.3 cm), curved, sharp points
- 18-1630** Micro-VANNAS Scissors 3/4" (8.3 cm), straight, ultrafine blades
- 18-1631** Micro-VANNAS Scissors 3/4" (8.3 cm), curved, ultrafine blades
- 18-1633** Micro Scissors 3/4" (8.3 cm), straight, superfine blades
- 18-1634** Micro Scissors 3/4" (8.3 cm), curved, superfine blades



18-1460 to 18-1476

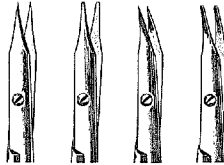

18-1460 to 18-1466

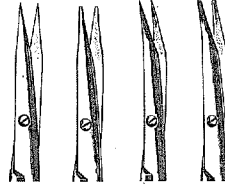

18-1470 to 18-1476

STEVENS TENOTOMY SCISSORS

- 18-1460 Straight sharp points 4½" (10.5 cm), short blades
- 18-1462 Straight blunt points 4½" (10.5 cm), short blades
- 18-1464 Curved sharp points 4½" (10.5 cm), short blades
- 18-1466 Curved blunt points 4½" (10.5 cm), short blades
- 18-1470 Straight sharp points 4½" (11.4 cm), long blades
- 18-1472 Straight blunt points 4½" (11.4 cm), long blades
- 18-1474 Curved sharp points 4½" (11.4 cm), long blades
- 18-1476 Curved blunt points 4½" (11.4 cm), long blades
- 18-1477* STEVENS Tenotomy Scissors 3¾" (9.5 cm), straight, blunt points, ribbon type
- 18-1478* STEVENS Tenotomy Scissors 3¾" (9.5 cm), curved, blunt points, ribbon type

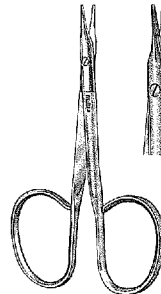

18-1477*
18-1478*

*Ribbon Type Scissors have extra large finger rings; shanks and rings have satin finish; blades are highly polished

Operating Scissors

Millex
N



18-1480



18-1482



18-1484

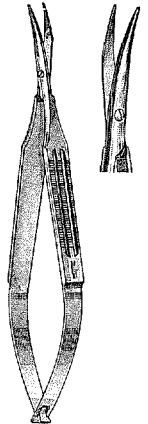

18-1487
18-1488

- 18-1480 WESTCOTT Utility Scissors 4½" (11.4 cm), curved, blunt tips
- 18-1482 SCHEIE-WESTCOTT Corneal Section Scissors 5" (12.7 cm), right, curved, blunt tips
- 18-1484 SCHEIE-WESTCOTT Corneal Section Scissors 5" (12.7 cm), left, curved, blunt tips
- 18-1487 WESTCOTT Tenotomy Scissors 5¼" (13.3 cm), right, wide handles
- 18-1488 WESTCOTT Tenotomy Scissors 5¼" (13.3 cm), left, wide handles
- 18-1494 Enucleation Scissors 5" (12.7 cm), light curve
- 18-1496 Enucleation Scissors 5" (12.7 cm), medium curve
- 18-1498 Enucleation Scissors 5" (12.7 cm), full curve

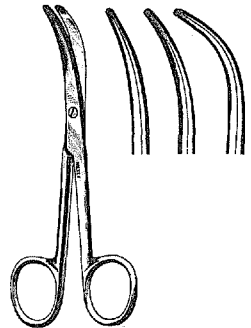

18-1494 to 18-1498

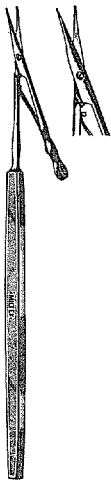

18-1540

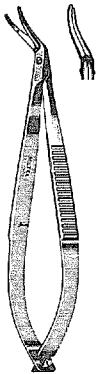

18-1560

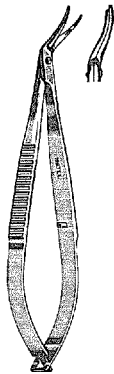

18-1562

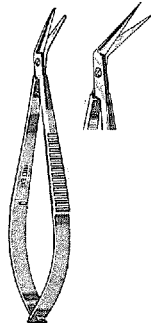

18-1570
18-1572

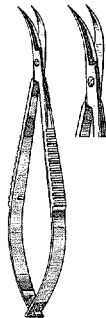

18-1576



18-1578

- 18-1540 NOYES Iridectomy Scissors 5½" (14 cm), straight, 7 mm blades, sharp-sharp points
- 18-1560 CASTROVIEJO Corneal Section Scissors 4½" (11.4 cm), right, inner blade 1 mm longer, blunt tips
- 18-1562 CASTROVIEJO Corneal Section Scissors 4½" (11.4 cm), left, inner blade 1 mm longer, blunt tips
- 18-1570 CASTROVIEJO Keratoplasty Scissors 3¾" (9.5 cm), angled blades 11 mm, sharp points
- 18-1572 CASTROVIEJO Keratoplasty Scissors 3¾" (9.5 cm), angled blades 11 mm, blunt points
- 18-1576 CASTROVIEJO Corneal Scissors 3¾" (9.5 cm), curved, sharp points
- 18-1578 CASTROVIEJO Corneal Scissors 3¾" (9.5 cm), curved, blunt points
- 18-1594 McGUIRE Corneal Scissors 4⅞" (10.5 cm), right
- 18-1596 McGUIRE Corneal Scissors 4⅞" (10.5 cm), left

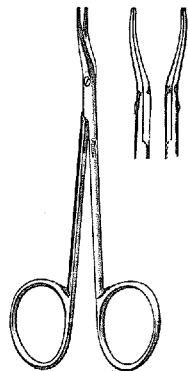

18-1594
18-1596

Operating Scissors

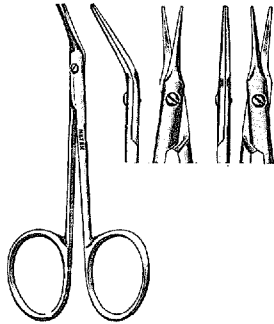

18-1600 to 18-1604

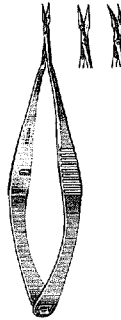

18-1620
18-1622

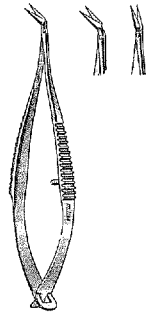

18-1623
18-1624

- 18-1600 AEBLI Corneal Scissors 4" (10.2 cm), straight
- 18-1602 AEBLI Corneal Scissors 4" (10.2 cm), angled on flat, right
- 18-1604 AEBLI Corneal Scissors 4" (10.2 cm), angled on flat, left
- 18-1620 VANNAS Capsulotomy Scissors 3¼" (8.3cm), straight, very delicate sharp points
- 18-1622 VANNAS Capsulotomy Scissors 3¼" (8.3 cm), curved, very delicate sharp points
- 18-1623 VANNAS Capsulotomy Scissors 3¼" (8.3 cm), angled to side, very delicate sharp points
- 18-1624 VANNAS Capsulotomy Scissors 3¼" (8.3 cm), angled on flat, very delicate sharp points
- 19-2060 WULLSTEIN Ear Scissors 3" (7.6 cm) shaft, straight, very delicate

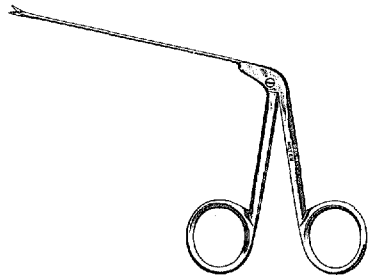

19-2060

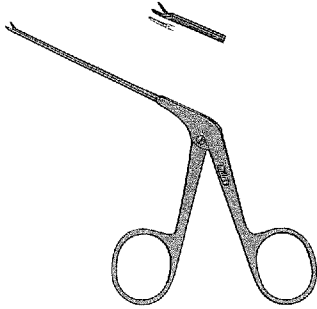

19-2150-B

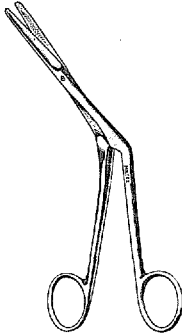

20-160

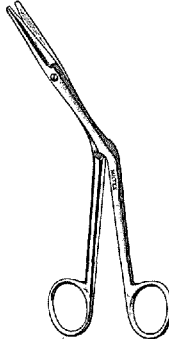

20-164

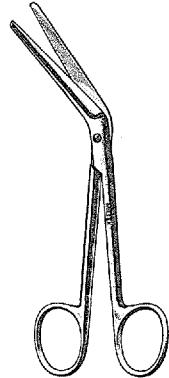

20-168

- 19-2150-B** BELLUCCI Micro Ear Scissors 2¾" (7 cm) shaft, 4 mm blades, ebony finish
- 20-160** KNIGHT Nasal Scissors 6¾" (17.1 cm), angled on side, standard pattern
- 20-164** HEYMAN Nasal Scissors 6¾" (17.1 cm), angled on side, rounded blades
- 20-168** SEILER Turbinate Scissors 6¾" (15.9 cm), angled on side

Operating Scissors

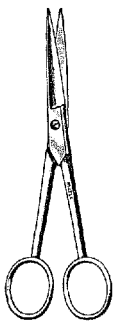

34-80



34-92

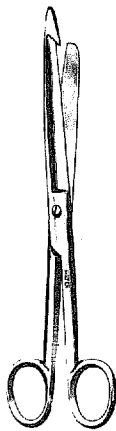

34-98

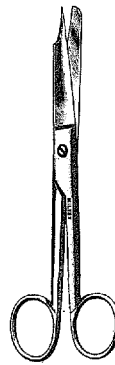

40-260

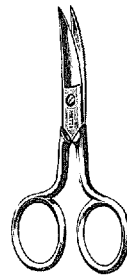

40-425

- 34-80 Dissecting Scissors 4½" (11.4 cm), straight, two sharp points, economy grade
- 34-92 RICHTER Dissecting Scissors 5" (12.7 cm), angular blades, one sharp and one blunt point
- 34-98 Enterotomy Scissors 8" (20.3 cm), with hook blade
- 40-260 Ingrown Nail Splitting Scissors 6" (15.2 cm), straight one serrated blade.
- 40-425 Nail Scissors 3½" (8.9 cm), curved blades, chrome
- 40-435 Cuticle Scissors 3½" (8.9 cm), curved blades, standard pattern, chrome
- 40-445 Cuticle Scissors 3½" (8.9 cm), curved blades, extra delicate, chrome

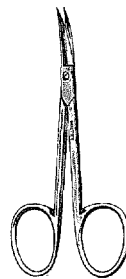

40-435

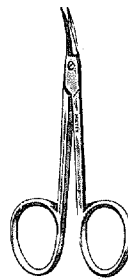

40-445



Bandage and Utility Scissors

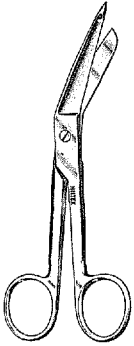

5-510 to 5-516

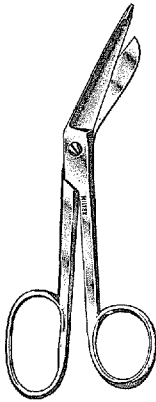

5-550

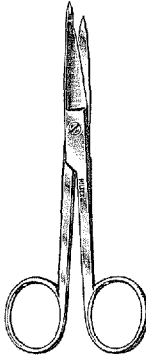

5-560

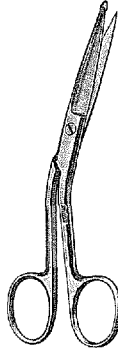

5-561

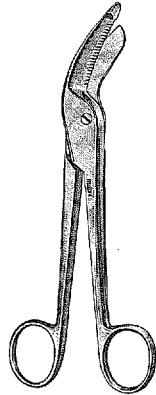

5-547

- 5-510 LISTER Bandage Scissors 3½" (8.9 cm), extra fine
- 5-512 LISTER Bandage Scissors 4½" (11.4 cm), extra fine
- 5-514 LISTER Bandage Scissors 5½" (14 cm), extra fine
- 5-516 LISTER Bandage Scissors 7¼" (18.4 cm), extra fine
- 5-550 LISTER Bandage Scissors 8" (20.3 cm), with one large finger ring

- 5-560 KNOWLES Bandage Scissors 5½" (14 cm), straight
- 5-561 KNOWLES Bandage Scissors 5½" (14 cm), shanks angled on side, serrated blade

- 5-547 HERCULES Heavy Duty Bandage and Plaster Shears 7½" (19.1 cm), serrated blade

- 5-564 U.S.A. Gauze Scissors 8" (20.3 cm), chrome

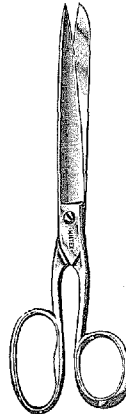

5-564

Bandage and Utility Scissors

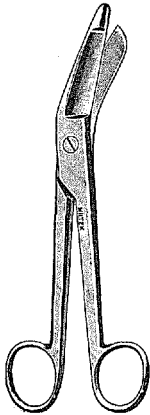

5-568

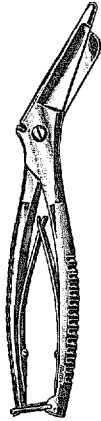

5-600

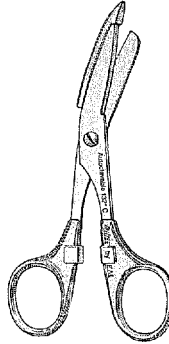

5-700
5-702

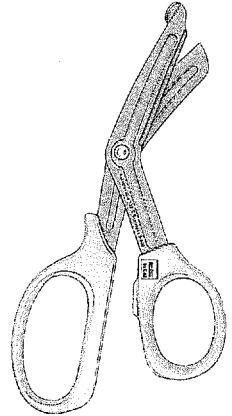

5-800

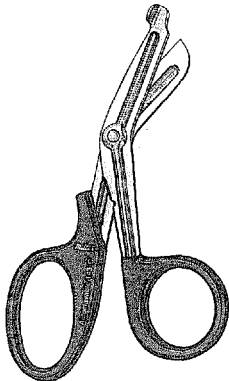

5-998
5-1000

- 5-568 ESMARCH Heavy Duty Bandage and Cast Shears 8" (20.3 cm)
- 5-600 MILTEX First Aid and Utility Shears 8½" (21.6 cm), with wire cutter and serrated blade
- Nurse's Scissors 5½" (14 cm). Fluoride coated blades help prevent adhesive from sticking to the blade surfaces. Scissors have plastic finger rings and safety guard. Supplied in a plastic carrying pouch. Autoclavable
- 5-700 Pink
- 5-702 Blue
- 5-800 Bandage and Utility Scissors 8½" (21.6 cm), with fluoride coated blades to help prevent adhesive or fiberglass casting material from sticking to the blade surfaces. Neon green plastic finger rings, serrated blade. Autoclavable
- 5-998 Bandage and Utility Scissors 6½" (16.5 cm), with needle destroyer, black plastic finger rings, serrated blade. Autoclavable
- 5-1000 Bandage and Utility Scissors 7½" (19.1 cm), with needle destroyer, black plastic finger rings, serrated blade. Autoclavable

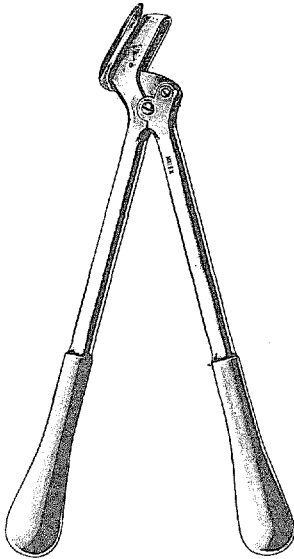

27-3059 to 27-3062

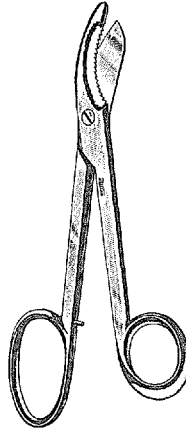

27-3070

- 27-3059 STILLE Plaster Shears 8" (20.3 cm), Pediatric Size, serrated blades
- 27-3060 STILLE Plaster Shears 11" (27.9 cm), Medium Size, serrated blades
- 27-3062 STILLE Plaster Shears 15" (38.2 cm), Standard Size, serrated blades
- 27-3070 BRUNS Plaster Shears 9¼" (23.5 cm), serrated blade

Carb-N-Sert Scissors



OUR TOP QUALITY LINE OF SURGICAL SCISSORS

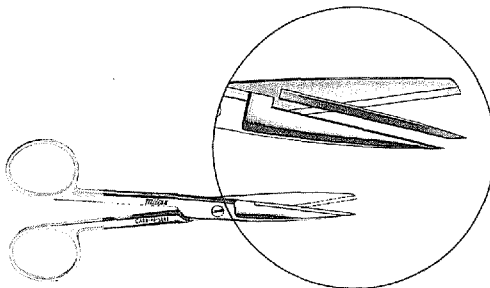

Manufactured to traditionally high Millex standards, these tungsten carbide blades are bonded to the finest quality stainless steel surgical scissors, then precision ground and honed on diamond wheels.

- Precision screws, fully tempered, will keep these scissors in perfect alignment.
- Scissors shanks are tempered to a hardness that permits proper flexibility.
- Finger rings are well rounded and polished for better "feel" and prevention of finger fatigue, and each instrument is satin finished to reduce glare.

Gold plated finger rings identify these tungsten carbide instruments, and the Millex catalog number has been etched on each scissors to facilitate re-ordering.

Carb-N-Sert Scissors will rarely require sharpening. While the initial cost of Carb-N-Sert Scissors is higher than standard stainless scissors, Carb-N-Sert Scissors represent a considerable savings to the user in the long run because of superior performance and longer service life.



Carb-N-Sert Scissors

CARB-N-SERT SCISSORS
with tungsten carbide insert blades will stay sharp for years

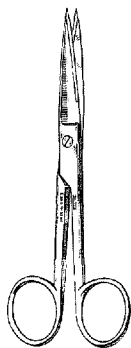

5-6TC

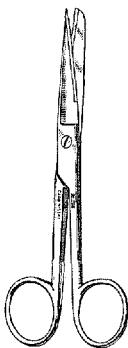

5-16TC

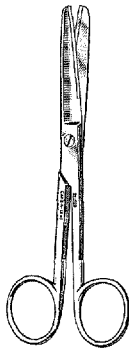

5-26TC

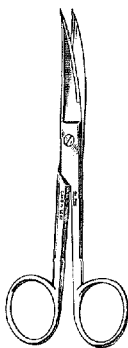

5-36TC

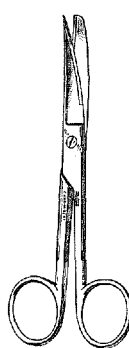

5-46TC

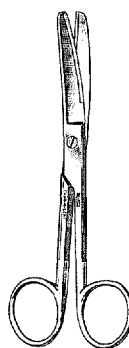

5-56TC

- 5-6TC Operating Scissors 5½" (14 cm), straight, sharp-sharp points
- 5-16TC Operating Scissors 5½" (14 cm), straight, sharp-blunt points
- 5-26TC Operating Scissors 5½" (14 cm), straight, blunt-blunt points
- 5-36TC Operating Scissors 5½" (14 cm), curved, sharp-sharp points
- 5-46TC Operating Scissors 5½" (14 cm), curved, sharp-blunt points
- 5-56TC Operating Scissors 5½" (14 cm), curved, blunt-blunt points

Carb-N-Sert Scissors



CARB-N-SERT SCISSORS

with tungsten carbide insert blades will stay sharp for years

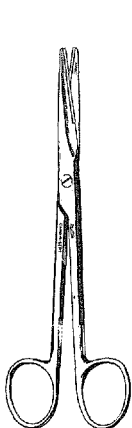

5-120TC
5-124TC

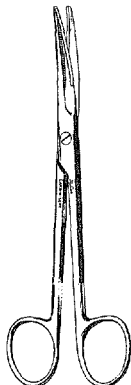

5-122TC
5-126TC

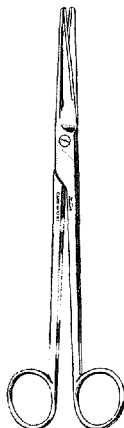

5-128TC
5-130TC

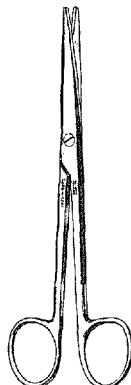

5-136TC
5-140TC



5-138TC
5-142TC

- | | |
|---------|---|
| 5-120TC | MAYO Dissecting Scissors 5½" (14 cm), straight, standard beveled blades |
| 5-122TC | MAYO Dissecting Scissors 5½" (14 cm), curved, standard beveled blades |
| 5-124TC | MAYO Dissecting Scissors 6¾" (17.1 cm), straight, standard beveled blades |
| 5-126TC | MAYO Dissecting Scissors 6¾" (17.1 cm), curved, standard beveled blades |
| 5-128TC | MAYO Dissecting Scissors 9" (22.9 cm), straight, standard beveled blades |
| 5-130TC | MAYO Dissecting Scissors 9" (22.9 cm), curved, standard beveled blades |
| 5-136TC | MAYO Dissecting Scissors 5½" (14 cm), straight, rounded blades |
| 5-138TC | MAYO Dissecting Scissors 5½" (14 cm), curved, rounded blades |
| 5-140TC | MAYO Dissecting Scissors 6¾" (17.1 cm), straight, rounded blades |
| 5-142TC | MAYO Dissecting Scissors 6¾" (17.1 cm), curved, rounded blades |



Carb-N-Sert Scissors

CARB-N-SERT SCISSORS
with tungsten carbide insert blades will stay sharp for years

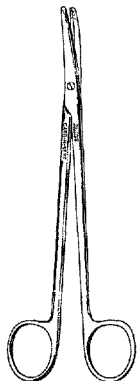

5-180TC
5-182TC

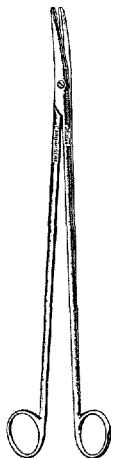

5-184TC 5-192TC
5-188TC 5-193A-TC
5-189A-TC



5-180A-TC

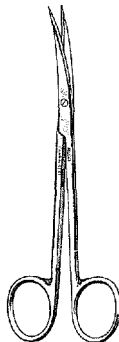

5-180B-TC

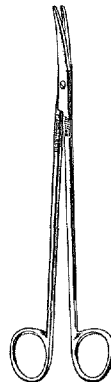

5-182A-TC

METZENBAUM SCISSORS STANDARD PATTERN — BLUNT POINTS

Straight	Length	Curved
5-179TC	5½" (14 cm)	5-180TC
5-181TC	7" (17.8 cm)	5-182TC
—	8" (20.3 cm)	5-184TC
5-186TC	9" (22.9 cm)	5-188TC
—	10" (25.4 cm)	5-189A-TC
—	11" (27.9 cm)	5-192TC
—	12" (30.5 cm)	5-193A-TC

METZENBAUM SCISSORS - DELICATE PATTERN

Straight	Length	Curved
5-179A-TC	5½" (14 cm) blunt points	5-180A-TC
5-179B-TC	5½" (14 cm) sharp points	5-180B-TC
5-181A-TC	7" (17.8 cm) blunt points	5-182A-TC
5-181B-TC	7" (17.8 cm) sharp points	5-182B-TC
5-187TC	9" (22.9 cm) blunt points	5-189TC

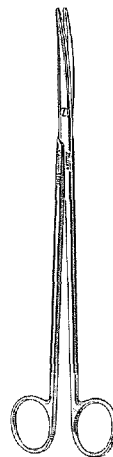

5-189TC

Carb-N-Sert Scissors



CARB-N-SERT SCISSORS
with tungsten carbide insert blades will stay sharp for years

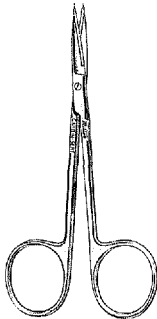

5-304TC

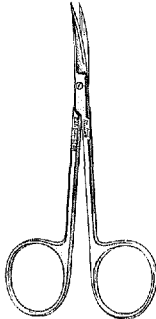

5-306TC

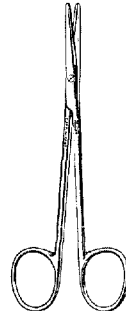

5-312TC

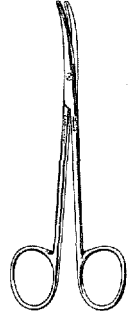

5-314TC

5-304TC Iris Scissors 4½" (11.4 cm), straight

5-306TC Iris Scissors 4½" (11.4 cm), curved

5-312TC Strabismus Scissors 4½" (11.4 cm), straight

5-314TC Strabismus Scissors 4½" (11.4 cm), curved



Carb-N-Sert Scissors

CARB-N-SERT SCISSORS
with tungsten carbide insert blades will stay sharp for years

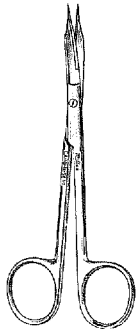

5-320TC

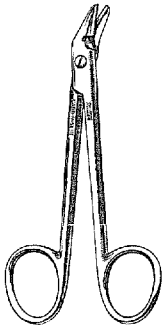

9-124TC

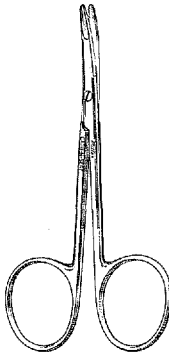

21-537TC

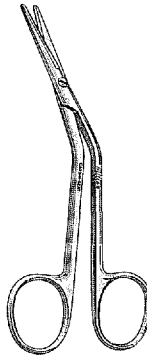

21-604TC

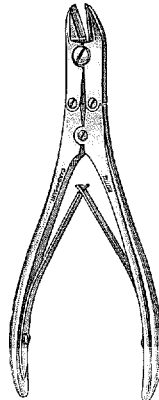

27-159TC

- 5-320TC** GOLDMAN-FOX Wound Debridement Scissors 5" (12.7 cm), curved fine tips, one serrated blade
- 9-124TC** Wire Cutting Scissors 4 $\frac{3}{4}$ " (12.1 cm), angled to side, one serrated blade
- 21-537TC** MILTEX Blepharoplasty Scissors 4 $\frac{1}{2}$ " (11.4 cm), curved flat tips, one serrated blade
- 21-604TC** FOMON Dorsal Scissors, 5 $\frac{1}{2}$ " (14 cm), angled shanks
- 27-159TC** C-N-S Pin and Wire Cutter 7" (17.8 cm), double action, cuts up to 2 mm ($\frac{5}{16}$ ") soft wire or 1.5 mm ($\frac{1}{16}$ ") hard wire

SuperCut Scissors

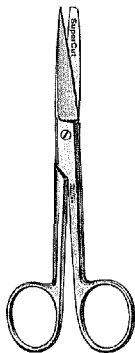

5-SC-16

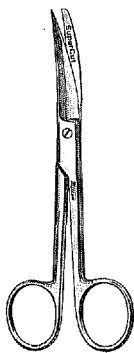

5-SC-46

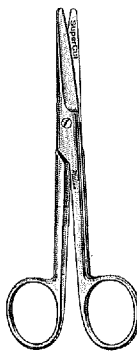

5-SC-120
5-SC-124

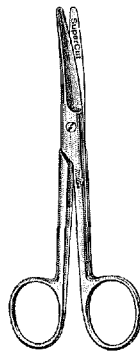

5-SC-122
5-SC-126

Manufactured with the highest quality stainless steel and German craftsmanship, Millex SuperCut Scissors are ideal for various surgical and dental procedures or applications. SuperCut Scissors have a specially designed razor-sharp upper blade edge that cuts effortlessly through tissue. The lower blade has micro-fine serrations to prevent tissue slippage. For easy identification, Millex SuperCut Scissors have two black finger rings.

Millex also offers SuperCut/Carb-N-Sert® Scissors, which have precision SuperCut performance with one lower serrated blade and one upper razor-sharp blade, as well as the durability of Tungsten Carbide cutting edges. These scissors are easily identified with one short and one long gold-plated finger ring.

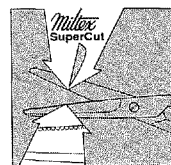

5-SC-16 Operating Scissors 5½" (14 cm), straight, sharp/blunt
5-SC-46 Operating Scissors 5½" (14 cm), curved, sharp/blunt

5-SC-120 MAYO Scissors 5½" (14 cm), straight
5-SC-122 MAYO Scissors 5½" (14 cm), curved
5-SC-124 MAYO Scissors 6¾" (17.1 cm), straight
5-SC-126 MAYO Scissors 6¾" (17.1 cm), curved



SuperCut Scissors

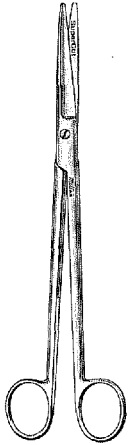

5-SC-128

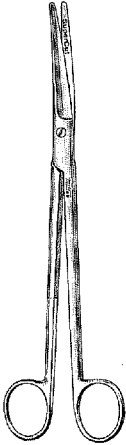

5-SC-130

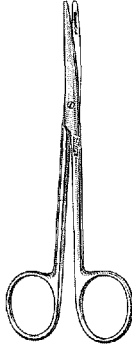

5-SC-180

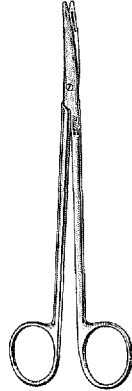

5-SC-182

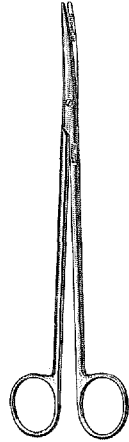

5-SC-188

- | | |
|----------|--|
| 5-SC-128 | MAYO Scissors 9" (22.9 cm), straight |
| 5-SC-130 | MAYO Scissors 9" (22.9 cm), curved |
| 5-SC-180 | METZENBAUM Scissors 5½" (14 cm), curved |
| 5-SC-182 | METZENBAUM Scissors 7" (17.8 cm), curved |
| 5-SC-188 | METZENBAUM Scissors 9" (22.9 cm), curved |

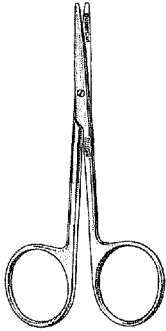

5-SC-283

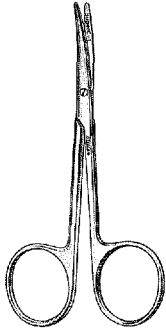

5-SC-284

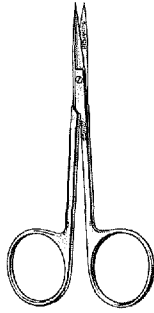

5-SC-304

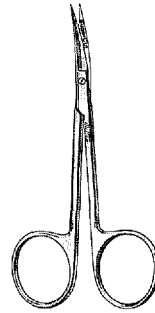

5-SC-306

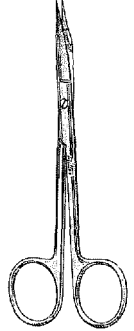

5-SC-320

- 5-SC-283 METZENBAUM Scissors 4½" (11.4 cm), straight, delicate
- 5-SC-284 METZENBAUM Scissors 4½" (11.4 cm), curved, delicate
- 5-SC-304 Iris Scissors 4½" (11.4 cm), straight
- 5-SC-306 Iris Scissors 4½" (11.4 cm), curved
- 5-SC-320 GOLDMAN-FOX Scissors 5" (12.7 cm), curved

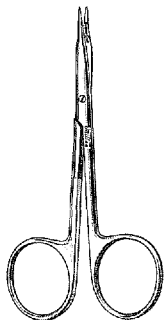

18-SC-1472

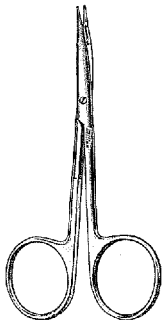

18-SC-1476

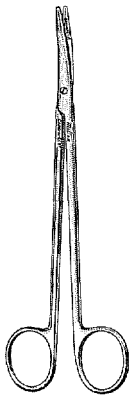

5-SC-182TC

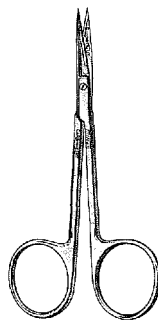

5-SC-304TC

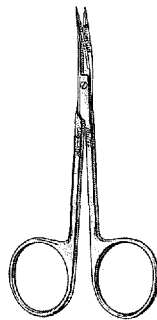

5-SC-306TC

18-SC-1472

STEVENS Tenotomy Scissors 4½" (11.4 cm), straight

18-SC-1476

STEVENS Tenotomy Scissors 4½" (11.4 cm), curved

5-SC-182TC

METZENBAUM Scissors 7" (17.8 cm), curved, SuperCut Carb-N-Sert Blades

5-SC-304TC

Iris Scissors 4½" (11.4 cm), straight, SuperCut Carb-N-Sert Blades

5-SC-306TC

Iris Scissors 4½" (11.4 cm), curved, SuperCut Carb-N-Sert Blades

Dressing and Tissue Forceps

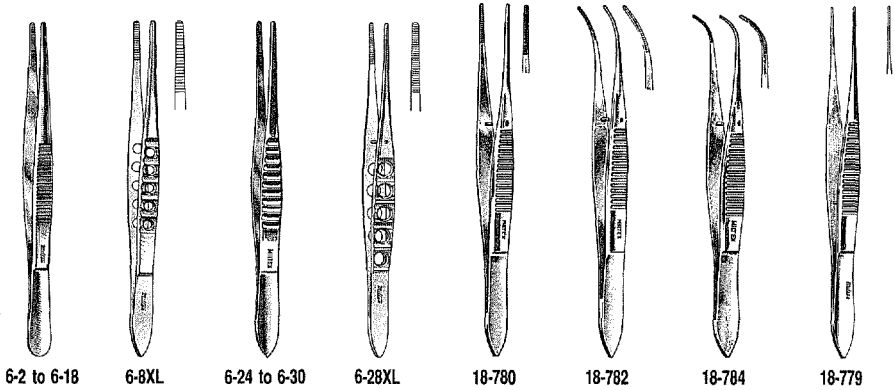

DRESSING FORCEPS, SERRATED TIPS

Standard Pattern Serrated Handles	Standard Pattern Lightweight with Fenestrated Handles	Length	Delicate Pattern Fluted Handles	Delicate Pattern Lightweight with Fenestrated Handles
6-2	—	4" (10.2 cm)	—	—
6-4	—	4½" (11.4 cm)	6-24	—
6-6	—	5" (12.7 cm)	6-26	—
6-8	6-8XL	5½" (14 cm)	6-28	6-28XL
6-10	—	6" (15.2 cm)	6-30	—
6-12	—	7" (17.8 cm)	—	—
6-14	—	8" (20.3 cm)	—	—
6-16	—	10" (25.4 cm)	—	—
6-18	—	12" (30.5 cm)	—	—

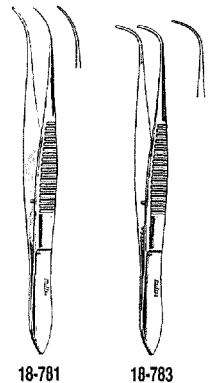

EYE DRESSING FORCEPS 4" (10.2cm), SERRATED TIPS

	Standard Pattern 0.8 mm wide tips	Extra Delicate Pattern 0.5 mm wide tips
18-780	Straight	18-779 Straight
18-782	Half curved	18-781 Half curved
18-784	Full curved	18-783 Full curved



6-40 to 6-86



6-44XL



6-90 to 6-96



TISSUE FORCEPS, 1 X 2 TEETH

Standard Pattern Serrated Handles	Standard Pattern Lightweight with Fenestrated Handles	Length	Delicate Pattern Fluted Handles
6-40	—	4½" (11.4 cm)	6-90
6-42	—	5" (12.7 cm)	6-92
6-44	6-44XL	5½" (14 cm)	6-94
6-46	—	6" (15.2 cm)	6-96
6-47	—	7" (17.8 cm)	—
6-48	—	8" (20.3 cm)	—
6-50	—	10" (25.4 cm)	—
6-52	—	12" (30.5 cm)	—
6-60	Tissue Forceps	4½" (11.4 cm)	2 x 3 teeth
6-62	Tissue Forceps	5" (12.7 cm)	2 x 3 teeth
6-64	Tissue Forceps	5½" (14 cm)	2 x 3 teeth
6-66	Tissue Forceps	6" (15.2 cm)	2 x 3 teeth
6-72	Tissue Forceps	5" (12.7 cm)	3 x 4 teeth
6-74	Tissue Forceps	5½" (14 cm)	3 x 4 teeth
6-76	Tissue Forceps	6" (15.2 cm)	3 x 4 teeth
6-82	Tissue Forceps	5" (12.7 cm)	4 x 5 teeth
6-84	Tissue Forceps	5½" (14 cm)	4 x 5 teeth
6-86	Tissue Forceps	6" (15.2 cm)	4 x 5 teeth

Dressing and Tissue Forceps



18-786
18-787



18-788



18-790



18-785

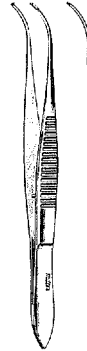

18-789

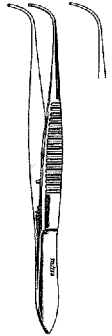

18-791

IRIS TISSUE FORCEPS 4" (10.2 cm), 1 x 2 TEETH

Standard Pattern
0.8 mm wide tips

- 18-786** Straight
- 18-787** Straight (Non Magnetic)
- 18-788** Half curved
- 18-790** Full curved

Extra Delicate Pattern
0.5 mm wide tips

- 18-785** Straight
- 18-789** Half curved
- 18-791** Full curved



6-100



6-104
6-109



6-106
6-108
6-109A



6-107

- 6-100 Dressing Forceps 5" (12.7 cm), curved narrow tips
- 6-104 SEMKEN Dressing Forceps 5" (12.7 cm), serrated
- 6-106 SEMKEN Tissue Forceps 5" (12.7 cm), 1 x 2 teeth
- 6-107 SEMKEN Tissue Forceps 5" (12.7 cm), 1 x 2 teeth, curved tips
- 6-108 SEMKEN Tissue Forceps 5" (12.7 cm), 2 x 3 teeth
- 6-109 SEMKEN Dressing Forceps 6" (15.2 cm), serrated
- 6-109A SEMKEN Tissue Forceps 6" (15.2 cm), 1 x 2 teeth

Dressing and Tissue Forceps

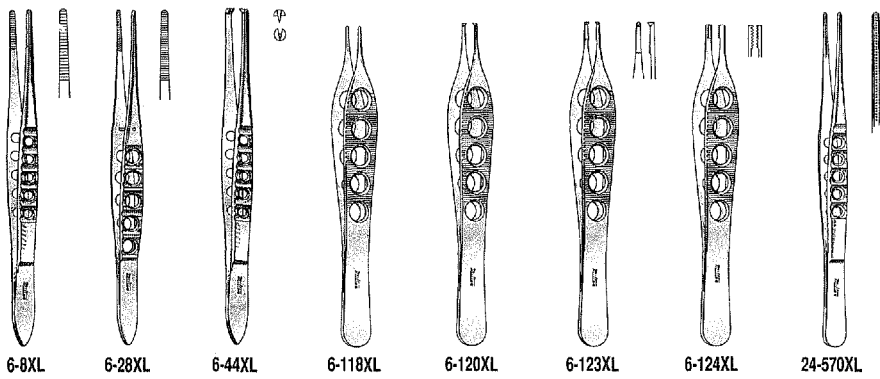

Lightweight Forceps with Fenestrated Handles provide the user with a firm, non-slip grip, reducing hand fatigue.

- 6-8XL** Dressing Forceps 5½" (14 cm), standard pattern
- 6-28XL** Dressing Forceps 5½" (14 cm), delicate pattern
- 6-44XL** Tissue Forceps 5½" (14 cm), 1 x 2 teeth, standard pattern
- 6-118XL** ADSON Dressing Forceps 4¾" (12.1 cm), serrated
- 6-120XL** ADSON Tissue Forceps 4¾" (12.1 cm), 1 x 2 teeth
- 6-123XL** ADSON Tissue Forceps 4¾" (12.1 cm), w/platform, 1 x 2 teeth
- 6-124XL** BROWN-ADSON Tissue Forceps 4¾" (12.1 cm), 7 x 7 side grasping teeth
- 24-570XL** DeBAKEY Tissue Forceps 6" (15.2 cm), atraumatic teeth, 1.5 mm wide tips

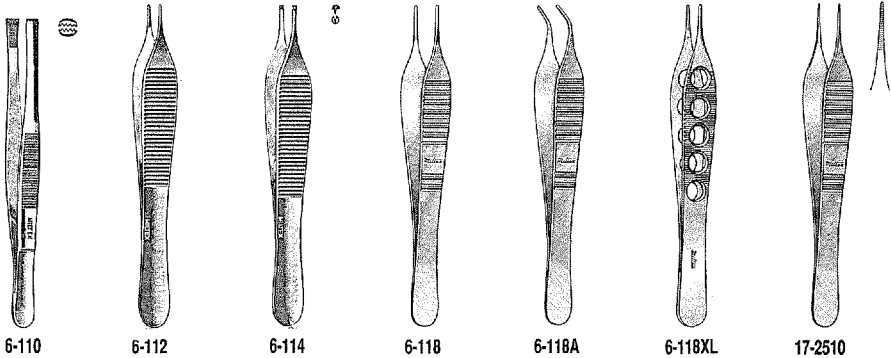

- 6-110** STILLE Pattern Tissue Forceps 5" (12.7 cm), 4 x 5 teeth
- 6-112** HUDSON (EWALD) Dressing Forceps 4¾" (12.1 cm), serrated
- 6-114** HUDSON (EWALD) Tissue Forceps 4¾" (12.1 cm), 1 x 2 teeth
- 6-118** ADSON Dressing Forceps 4¾" (12.1 cm), serrated, delicate
- 6-118A** ADSON Dressing Forceps 4¾" (12.1 cm), serrated, delicate, angled
- 6-118XL** ADSON Dressing Forceps 4¾" (12.1 cm), serrated, lightweight, fenestrated handles
- 17-2510** Micro ADSON Dressing Forceps 4¾" (12.1 cm), serrated tips, 0.5 mm wide

Dressing and Tissue Forceps



6-120
6-122



6-120A



6-120XL

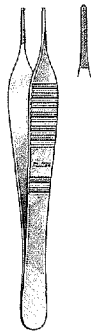

6-121



17-2500



6-123

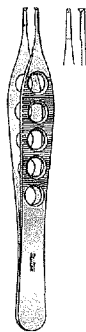

6-123XL

- 6-120 ADSON Tissue Forceps 4¾" (12.1 cm), 1 x 2 teeth, delicate
- 6-120A ADSON Tissue Forceps 4¾" (12.1 cm), 1 x 2 teeth, delicate, angled
- 6-120XL ADSON Tissue Forceps 4¾" (12.1 cm), 1 x 2 teeth, lightweight, fenestrated handles
- 6-121 ADSON Tissue Forceps 4¾" (12.1 cm), 1 x 2 teeth and cross serrated tips, delicate
- 17-2500 Micro ADSON Tissue Forceps 4¾" (12.1 cm), tips 0.5 mm wide, 1 x 2 teeth
- 6-122 ADSON Tissue Forceps 4¾" (12.1 cm), 2 x 3 teeth, delicate
- 6-123 ADSON Tissue and Suture Forceps 4¾" (12.1 cm), 1 x 2 teeth with tying platform
- 6-123XL ADSON Tissue Forceps 4¾" (12.1 cm), w/platform, 1 x 2 teeth, lightweight, fenestrated handles
- 6-124 BROWN-ADSON Tissue Forceps 4¾" (12.1 cm), 7 x 7 side grasping teeth
- 6-124XL BROWN-ADSON Tissue Forceps 4¾" (12.1 cm), 7 x 7 side grasping teeth, lightweight, fenestrated handles
- 6-125 DeBAKEY-ADSON Tissue Forceps 4¾" (12.1 cm), atraumatic tips 1.5 mm wide



6-124

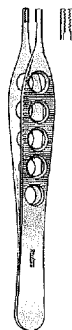

6-124XL



6-125



Dressing and Tissue Forceps



6-126



6-128



6-132

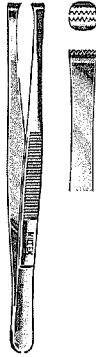

6-134
6-136

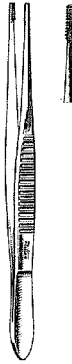

6-138 to 6-141



6-142 to 6-145

6-126 BROWN-ADSON Tissue Forceps 4 $\frac{1}{4}$ " (12.1 cm), 7 x 7 side grasping teeth, angular

6-128 HEANEY Tissue Forceps 5 $\frac{1}{2}$ " (14 cm), 2 x 3 teeth and cross serrated tips

6-132 STONE Tissue Forceps 6" (15.2 cm), 4 x 5 teeth

6-134 MARTIN Tissue Forceps 6" (15.2 cm), 7 x 8 teeth

6-136 MARTIN Tissue Forceps 7 $\frac{1}{2}$ " (19.1 cm), 7 x 8 teeth

6-138 BROWN Tissue Forceps 6" (15.2 cm), 8 x 8 side grasping teeth

6-140 BROWN Tissue Forceps 8" (20.3 cm), 8 x 8 side grasping teeth

6-141 BROWN Tissue Forceps 10" (25.4 cm), 8 x 8 side grasping teeth

6-142 RUSSIAN Tissue Forceps 6" (15.2 cm)

6-144 RUSSIAN Tissue Forceps 8" (20.3 cm)

6-145 RUSSIAN Tissue Forceps 10" (25.4 cm)

6-148 BONNEY Tissue Forceps 7" (17.8 cm), 1 x 2 teeth and serrated tips

6-150 BONNEY Tissue Forceps 7" (17.8 cm), 2 x 3 teeth and serrated tips

6-154 POTTS-SMITH Dressing Forceps 7" (17.8 cm), serrated

6-156 POTTS-SMITH Dressing Forceps 8 $\frac{1}{4}$ " (21 cm), serrated

6-158 POTTS-SMITH Dressing Forceps 9 $\frac{1}{2}$ " (24.1 cm), serrated

6-159 POTTS-SMITH Dressing Forceps 12" (30.5 cm), serrated

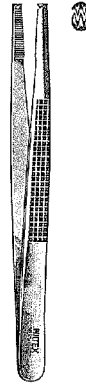

6-148
6-150



6-154 to 6-159

Dressing and Tissue Forceps

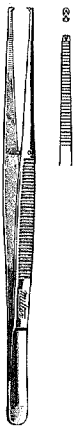

6-160 to 6-164A



6-166

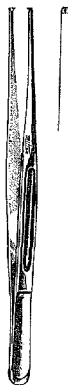

6-168



6-180

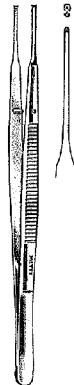

6-182

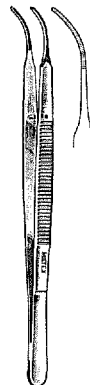

6-184

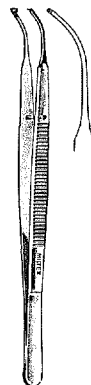

6-186

6-160 POTTS-SMITH Tissue Forceps 7" (17.8 cm), 1 x 2 teeth and serrated tips

6-162 POTTS-SMITH Tissue Forceps 8 1/4" (21 cm), 1 x 2 teeth and serrated tips

6-164 POTTS-SMITH Tissue Forceps 9 1/2" (24.1 cm), 1 x 2 teeth and serrated tips

6-164A POTTS-SMITH Tissue Forceps 12" (30.5 cm), 1 x 2 teeth and serrated tips

6-166 CUSHING Dressing Forceps 7" (17.8 cm), serrated, Gutch handle, scraper end

6-168 CUSHING Tissue Forceps 7" (17.8 cm), 1 x 2 teeth, Gutch handle, scraper end

6-180 GERALD Dressing Forceps 7" (17.8 cm), straight, serrated

6-182 GERALD Tissue Forceps 7" (17.8 cm), straight, 1 x 2 teeth

6-184 GERALD Dressing Forceps 7" (17.8 cm), curved, serrated

6-186 GERALD Tissue Forceps 7" (17.8 cm), curved, 1 x 2 teeth

6-188 CUSHING Dressing Forceps 7" (17.8 cm), serrated, scraper end

6-189 CUSHING Tissue Forceps 7" (17.8 cm), 1 x 2 teeth, scraper end



6-188



6-189



Dressing and Tissue Forceps



6-190



6-192

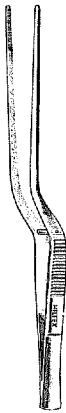

6-197
6-198



6-200 to 6-204



6-210

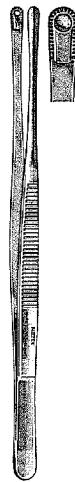

6-212

- 6-190 CUSHING Dressing Forceps 7¼" (18.4 cm), bayonet, serrated, scraper end
- 6-192 CUSHING Tissue Forceps 7¼" (18.4 cm), bayonet, 1 x 2 teeth, scraper end
- 6-197 GRUENWALD (JANSEN) Bayonet Dressing Forceps 6½" (16.5 cm), serrated
- 6-198 ADSON Bayonet Dressing Forceps 8¼" (21 cm), serrated
- 6-200 KELLY Tissue Forceps 9" (22.9 cm), 1 x 2 teeth, slotted Gutch handle
- 6-202 KELLY Tissue Forceps 9" (22.9 cm), 2 x 3 teeth, slotted Gutch handle
- 6-204 KELLY Tissue Forceps 9" (22.9 cm), 3 x 4 teeth, slotted Gutch handle
- 6-210 MAYO RUSSIAN Tissue Forceps 9" (22.9 cm), fenestrated jaws, slotted grooved handles
- 6-212 DAVIS Tissue Forceps 10" (25.4 cm)
- 6-214 SINGLEY Tissue Forceps 9" (22.9 cm), fenestrated serrated jaws
- 16-80 WANGENSTEEN Tissue Forceps 9" (22.9 cm), rounded jaws with fine cross serrations

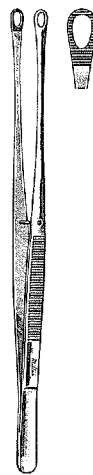

6-210



16-80

Dressing and Tissue Forceps

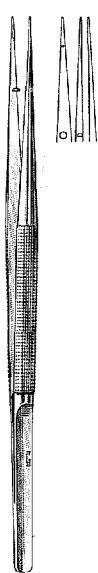

17-1100

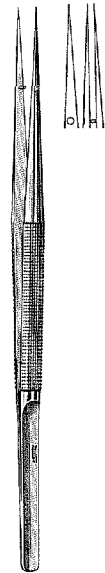

17-1150

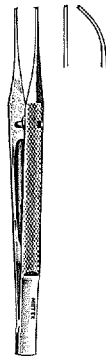

18-620
18-624

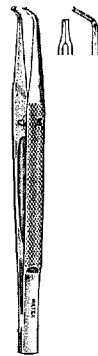

18-632



18-793

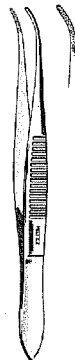

18-794

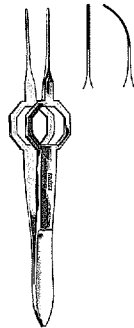

18-795
18-795A

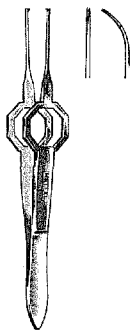

18-796
18-798

- 17-1100 RHOTON Micro Suture Forceps 7" (17.8 cm), straight, with 0.7 mm tying platform
- 17-1150 RHOTON Micro Forceps 7" (17.8 cm), straight, 0.3 mm tips
- 18-620 KIRBY Iris Tissue Forceps 4" (10.2 cm), straight, 1 x 2 teeth
- 18-624 KIRBY Iris Tissue Forceps 4" (10.2 cm), curved, 1 x 2 teeth
- 18-632 KIRBY Tissue Forceps 4" (10.2 cm), angled tips with 1 x 2 teeth
- 18-793 O'CONNOR Iris Tissue Forceps 3¾" (9.5 cm), angular jaws 0.5 x 9 mm with 1 x 2 teeth
- 18-794 BRACKEN Iris Dressing Forceps 4" (10.2 cm), with fine cross-serrated tips
- 18-795 FOERSTER Eye Dressing Forceps 3¾" (9.5 cm), octagonal grip, straight, serrated tips 0.5 mm wide
- 18-795A FOERSTER Eye Dressing Forceps 3¾" (9.5 cm), octagonal grip, full curved, serrated tips 0.5 mm wide
- 18-796 FOERSTER Iris Tissue Forceps 3¾" (9.5 cm), octagonal grip, straight, 1 x 2 teeth, 0.5 mm wide
- 18-798 FOERSTER Iris Tissue Forceps 3¾" (9.5 cm), octagonal grip, full curved, 1 x 2 teeth, 0.5 mm wide



Dressing and Tissue Forceps



18-804



18-814
18-816



18-818
18-820



18-825



18-834

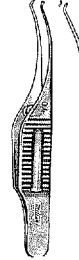

18-827
18-828

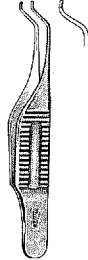

18-829

- 18-804** STEVENS Iris Tissue Forceps 4" (10.2 cm), straight, 1 x 2 teeth, 1 mm wide
- 18-814** GRAEFE Eye Dressing Forceps 2 3/4" (7 cm), straight, serrated
- 18-816** GRAEFE Iris Tissue Forceps 2 3/4" (7 cm), straight, 1 x 2 teeth
- 18-818** GRAEFE Eye Dressing Forceps 2 3/4" (7 cm), curved, serrated
- 18-820** GRAEFE Iris Tissue Forceps 2 3/4" (7 cm), curved, 1 x 2 teeth
- 18-825** GILL (CHANDLER) Iris Dressing Forceps 3" (7.6 cm), fine cross serrated tips, 0.6 mm wide
- 18-834** GILL Iris Tissue Forceps 2 5/8" (7.3 cm), tips 0.6 mm wide, with 1 x 2 teeth
- 18-827** TROUTMAN-BARRAQUER Colibri Type Tissue Forceps 3" (7.6 cm), with 1 x 2 teeth, 0.4 mm, set at 45° angle, with tying platform
- 18-828** TROUTMAN-BARRAQUER Colibri Type Tissue Forceps 3" (7.6 cm), with 1 x 2 teeth, 0.12 mm, set at 45° angle, with tying platform
- 18-829** BOTVIN Iris Dressing Forceps 2 5/8" (7.3 cm), fine cross serrated tips, 0.5 mm wide
- 18-830** GILL HESS Iris Forceps 2 3/4" (7 cm), with 1 x 2 teeth forward 0.5 mm
- 18-835** BONN Micro Tissue Forceps 2 3/4" (7 cm), 1 x 2 teeth 0.12 mm, with tying platform

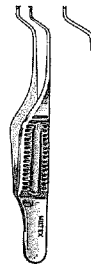

18-830

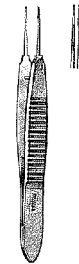

18-835

Dressing and Tissue Forceps

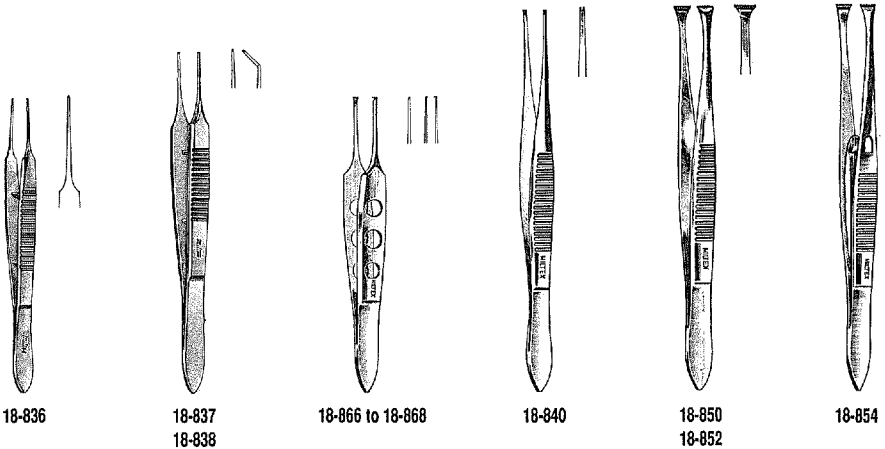

- 18-836** BONN Micro Tissue Forceps 3¾" (9.5 cm), 1 x 2 teeth 0.12 mm, with tying platform
- 18-837** McPHERSON Micro Tissue Forceps 3½" (8.9 cm), straight, 1 x 2 teeth 0.2 mm, with tying platform
- 18-838** McPHERSON Micro Tissue Forceps 3½" (8.9 cm), angled, 1 x 2 teeth 0.2 mm, with tying platform
- 18-866** BISHOP-HARMON Dressing Forceps 3¾" (8.6 cm), fine cross serrated tips 0.5 mm wide
- 18-867** BISHOP-HARMON Micro Tissue Forceps 3¾" (8.6 cm), delicate 0.3 mm 1 x 2 teeth
- 18-868** BISHOP-HARMON Tissue Forceps 3¾" (8.6 cm), standard 0.7 mm 1 x 2 teeth
- 18-840** Strabismus Tissue Forceps 4" (10.2 cm), 1 mm wide tips with 1 x 2 teeth
- 18-850** GRAEFE Tissue Forceps 4¾" (11.2 cm), standard jaws 4.5 mm wide, with fine teeth
- 18-852** GRAEFE Tissue Forceps 4¾" (11.2 cm), standard jaws 4.5 mm wide, with fine teeth, Non-Magnetic
- 18-854** GRAEFE Tissue Forceps 4¾" (11.2 cm), standard jaws 4.5 mm wide, with fine teeth, with catch



Dressing and Tissue Forceps

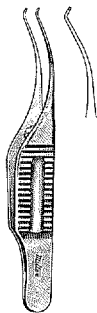

18-880
18-881



18-883

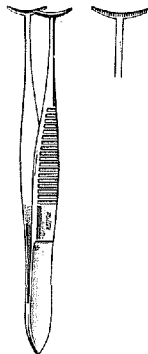

18-896
18-897



18-912



18-914

- 18-880** PIERSE Colibri Type Tissue Forceps 3/4" (8.3 cm), tips 0.12 mm
18-881 PIERSE Colibri Type Tissue Forceps 3/4" (8.3 cm), tips 0.3 mm
18-883 CASTROVIEJO Colibri Type Tissue Forceps 4" (10.2 cm), tips 0.12 mm, with tying platform
18-896 GREEN Tissue Forceps 4" (10.2 cm), T-shape, 12 mm wide 19 x 20 teeth
18-897 GREEN Tissue Forceps 4" (10.2 cm), T-shape, 5 mm wide 8 x 9 teeth
18-912 LESTER Tissue Forceps 3/4" (9.5 cm), delicate 1 x 2 teeth, 0.6 mm wide
18-914 LESTER Tissue Forceps 3/4" (9.5 cm), delicate 2 x 3 teeth, 1 mm wide

Dressing and Tissue Forceps



18-916

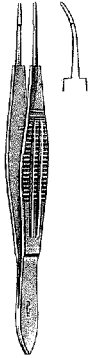

18-946
18-947

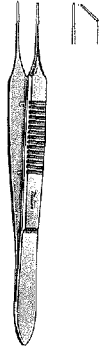

18-948
18-949



18-956
18-958

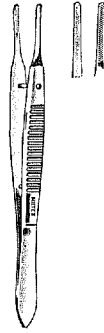

18-962
18-964



18-966

- 18-916** HARMON Tissue Forceps 3" (7.6 cm), 4 x 5 teeth, delicate 2.5 mm wide tips
- 18-946** HARMS Suturing Forceps 4½" (10.5 cm), straight, with 11 mm wide handles, tying platform, 0.6 mm wide at tip
- 18-947** HARMS Suturing Forceps 4½" (10.5 cm), curved, with 11 mm wide handles, tying platform, 0.6 mm wide at tip
- 18-948** McPHERSON Micro Iris Suturing Forceps 3½" (8.9 cm), straight, tying platform 0.3 x 5 mm, no teeth
- 18-949** McPHERSON Micro Iris Suturing Forceps 3½" (8.9 cm), angled, tying platform 0.3 x 5 mm, no teeth
- 18-956** NUGENT Utility Forceps 4¼" (10.8 cm), smooth tips 1.2 mm wide
- 18-958** NUGENT Utility Forceps 4¼" (10.8 cm), cross serrated tips 1.2 mm wide
- 18-962** McCULLOUGH Utility Forceps 4" (10.2 cm), smooth tips 1.5mm wide
- 18-964** McCULLOUGH Utility Forceps 4" (10.2 cm), cross serrated tips 1.5 mm wide
- 18-966** McCULLOUGH Suturing Forceps 4" (10.2 cm), cross serrated tips 1.5 mm wide with 1 x 2 teeth



Dressing and Tissue Forceps



18-970



18-971



18-978



18-1100



18-1102



18-1104

- 18-970** WILL'S HOSPITAL Utility Forceps 4" (10.2 cm), with cross serrated tying platform 1.2 mm wide
- 18-971** BONACCOLTO Utility Forceps 4" (10.2 cm), longitudinal serrations with cross serrations on tip, 1.2 mm wide with tapered tips
- 18-978** SCHAAF Foreign Body Forceps 3¾" (9.5 cm), grooved tips
- 18-1100** LITTAUER Cilia Forceps 3½" (8.9 cm), 4 mm wide jaws with fine horizontal serrations
- 18-1102** BEER Cilia Forceps 3½" (8.9 cm), 4 mm wide smooth jaws
- 18-1104** ZIEGLER Cilia Forceps 3½" (8.9 cm), 2 mm wide smooth jaws

Dressing and Tissue Forceps



18-1106



18-1107

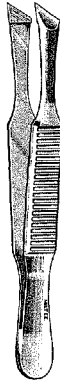

18-1108



18-1110



18-1111



18-1112

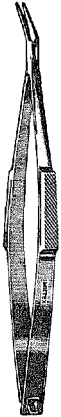

18-1114

- 18-1106 DOUGLAS Cilia Forceps 3½" (8.9 cm), thin tips 2.5 mm wide, with fine horizontal serrations
- 18-1107 Swiss Cilia and Suture Forceps 3¾" (9.5 cm), precision fitted diagonal jaws 3 mm wide
- 18-1108 BERGH Cilia Forceps 4¼" (10.8 cm), 10 mm wide jaws with horizontal serrations
- 18-1110 BERGH Cilia Forceps 3½" (8.9 cm), 5 mm wide jaws with horizontal serrations
- 18-1111 BARRAQUER Cilia and Suture Forceps 4½" (11.4 cm), with 5 mm smooth platform
- 18-1112 BENNETT Cilia Forceps 3" (7.6 cm), cup shaped jaws 3 mm diameter
- 18-1114 BEAUPRE Cilia Forceps 4½" (11.4 cm), smooth jaws 12 mm long, 45° angle
- 18-1116 GRADLE Cilia Forceps 4" (10.2 cm), precision ground jaws 1.4 mm wide



18-1116



Dressing and Tissue Forceps

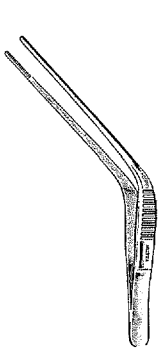

19-350

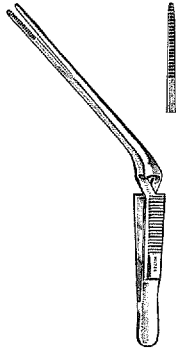

19-356

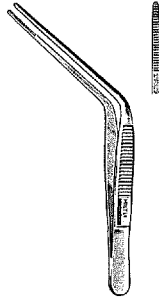

19-360



19-370



19-371

- 19-350 WILDE Dressing Forceps 5" (12.7 cm), angular with serrated tips
- 19-356 WILDE Dressing Forceps 5 1/4" (13.3 cm), cross action, angular with serrated tips
- 19-360 BLAKE Dressing Forceps 4 1/2" (11.4 cm), very delicate, angular with serrated tips
- 19-370 LUCAE Dressing Forceps 5 1/2" (14 cm), bayonet shape with serrated tips
- 19-371 JANSEN Dressing Forceps 6 1/4" (15.9 cm), bayonet shape, extra delicate pattern with 2 mm wide serrated tips
- 20-120 WILDE Dressing Forceps 6 1/2" (16.5 cm), angular

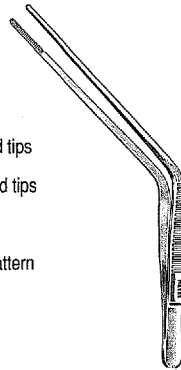

20-120

Dressing and Tissue Forceps

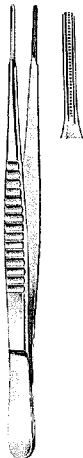

24-550
to
24-556



24-570
to
24-574



24-570XL

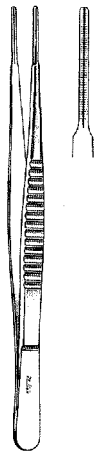

24-580
24-582

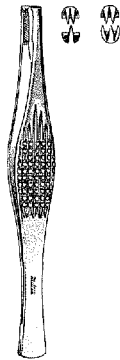

26-956
26-958



33-500

DeBAKEY ATRAUMATIC TISSUE FORCEPS, 2.5 cm wide tips

24-550	6" (15.2 cm)	24-554	9½" (24.1 cm)
24-552	7¾" (19.7 cm)	24-556	12" (30.5 cm)

DeBAKEY ATRAUMATIC TISSUE FORCEPS, 1.5 mm wide jaw tips

24-570	6" (15.2 cm)
24-570XL	6" (15.2 cm) lightweight with fenestrated handles
24-572	8" (20.3 cm)
24-574	9½" (24.1 cm)

24-580	COOLEY Atraumatic Tissue Forceps 6" (15.2 cm), tips 2 mm wide
24-582	COOLEY Atraumatic Tissue Forceps 8" (20.3 cm), tips 2 mm wide
26-956	FERRIS SMITH Tissue Forceps 7" (17.8 cm), serrated platform tips with 1 x 2 teeth
26-958	FERRIS SMITH Tissue Forceps 7" (17.8 cm), serrated platform tips with 2 x 3 teeth
33-500	MILTEX Depilatory Forceps 5½" (13.3 cm), flat square tips with deep serrations



6-300
to
6-304



6-308



6-310

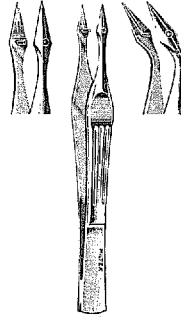

6-312
6-314

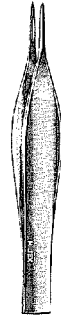

6-316
6-318

- 6-300 Plain Splinter Forceps 3½" (8.9 cm)
- 6-302 Plain Splinter Forceps 4" (10.2 cm)
- 6-304 Plain Splinter Forceps 4½" (11.4 cm)
- 6-308 CARMALT Splinter Forceps 4¼" (10.8 cm), straight
- 6-310 CARMALT Splinter Forceps 4¼" (10.8 cm), curved
- 6-312 WALTER Splinter Forceps 4¼" (10.8 cm), straight
- 6-314 WALTER Splinter Forceps 4¼" (10.8 cm), curved
- 6-316 FEILCHENFELD Splinter Forceps 3" (7.6 cm)
- 6-318 FEILCHENFELD Splinter Forceps 4½" (11.4 cm)

Splinter Forceps

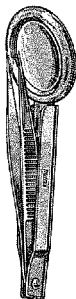

V96-329

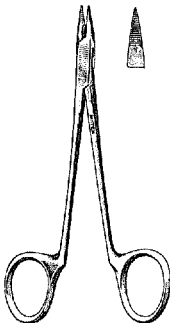

6-330

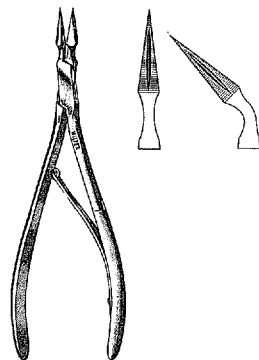

6-336
6-337

- V96-329 Splinter Forceps 3" (7.6 cm), with magnifying glass, in carrying case
- 6-330 Physicians' Splinter Forceps 5" (12.7 cm)
- 6-336 VIRTUS Splinter Forceps 6" (15.2 cm), straight
- 6-337 VIRTUS Splinter Forceps 6" (15.2 cm), 45° angle
- 6-338 WILLIAMS Splinter Forceps 5½" (14 cm), straight
- 6-340 WILLIAMS Splinter Forceps 5½" (14 cm), 45° angle
- 6-342 WILLIAMS Splinter Forceps 5½" (14 cm), right angle

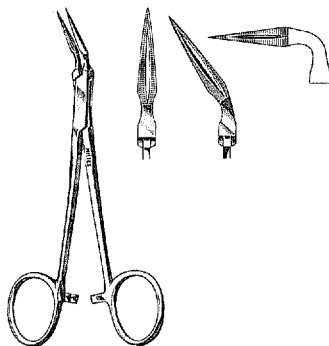

6-338
6-340
6-342



Splinter Forceps

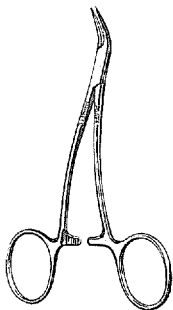

6-350



6-400

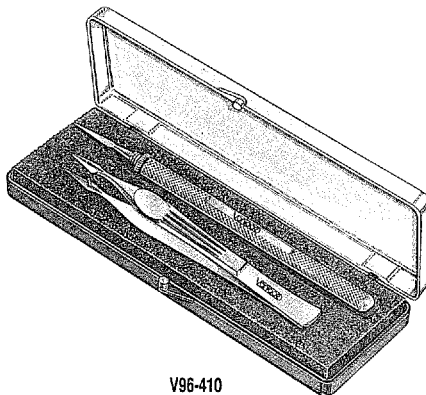

V96-410

V96-415

- 6-350 PEET Splinter Forceps 4 $\frac{3}{4}$ " (12.1 cm), double curve
- 6-400 MILTEX Splinter Liberator 5" (12.7 cm), trocar point in reversible handle
- V96-410 Professional Splinter Removal Kit. The Liberator is used to approach the embedded fragment by elevating the epidermis. After the fragment is exposed, the Walter Forceps is used for quick and easy removal of splinter.
- V96-415 Display carton with 12 ea. V96-410 Professional Splinter Removal Kits (not shown)

Splinter Forceps



17-301



17-302



17-303



17-303C



17-303X



17-304

SWISS JEWELER STYLE FORCEPS Non-Magnetic Stainless Steel

- 17-301 Style 1, fine, $4\frac{3}{4}$ " (12.1 cm)
- 17-302 Style 2, strong, fine, $4\frac{3}{4}$ " (12.1 cm)
- 17-303 Style 3, narrow, fine, $4\frac{3}{4}$ " (12.1 cm)
- 17-303C Style 3C, narrow, fine, $4\frac{3}{8}$ " (11.2 cm)
- 17-303X Style 3, micro-fine, $4\frac{3}{4}$ " (12.1 cm)
- 17-304 Style 4, fine, $4\frac{3}{8}$ " (11.2 cm)
- 17-305 Style 5, super fine, $4\frac{3}{8}$ " (11.2 cm)



17-305



Splinter Forceps



17-305X



17-306



17-307



17-307X



18-980

SWISS JEWELER STYLE FORCEPS Non-Magnetic Stainless Steel

- 17-305X Style 5, micro-fine, $4\frac{3}{8}$ " (11.2 cm)
- 17-306 Style 6, pickup, $4\frac{1}{2}$ " (11.4 cm)
- 17-307 Style 7, fine curved, $4\frac{1}{2}$ " (11.4 cm)
- 17-307X Style 7, micro-fine, curved, $4\frac{1}{2}$ " (11.4 cm)
- 18-980 THORPE Splinter Forceps 4" (10.2 cm), very sharp points, fine serrated tips

Carb-N-Sert Dressing and Tissue Forceps



CARB-N-SERT DRESSING & TISSUE FORCEPS
with tungsten carbide insert tips permit atraumatic and firm
grasp of tissue. Tips have 4000 teeth per square inch



6-30TC

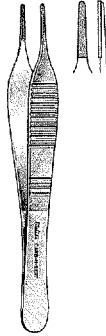

6-118TC



6-123TC

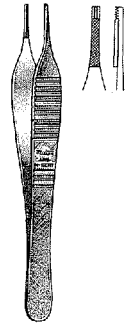

6-124TC

- 6-30TC Dressing Forceps 6" (15.2 cm), cross serrated tips
- 6-118TC ADSON Dressing Forceps 4¾" (12.1 cm), cross serrated tips
- 6-123TC ADSON Tissue and Suture Forceps 4¾" (12.1 cm), 1 x 2 teeth and cross serrated tying platform
- 6-124TC BROWN-ADSON Tissue and Suture Forceps 4¾" (12.1 cm), 7 x 7 side grasping teeth and cross serrated tying platform



Carb-N-Sert Dressing and Tissue Forceps

CARB-N-SERT DRESSING & TISSUE FORCEPS
with tungsten carbide insert tips permit atraumatic and firm
grasp of tissue. Tips have 4000 teeth per square inch



6-154TC to 6-158TC



6-165TC

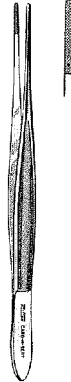

6-166TC



6-198TC

- 6-154TC POTTSMITH Dressing Forceps 7" (17.8 cm), cross serrated tips
- 6-156TC POTTSMITH Dressing Forceps 8¼" (21 cm), cross serrated tips
- 6-158TC POTTSMITH Dressing Forceps 9¾" (24.8 cm), cross serrated tips
- 6-165TC EVANS Pelvic Tissue Forceps 10" (25.4 cm), cross serrated tips
- 6-166TC CUSHING Dressing Forceps 7" (17.8 cm), Gutch handle, cross serrated tips
- 6-198TC ADSON Bayonet Dressing Forceps 8½" (21.6 cm), cross serrated tips

Hemostatic Forceps

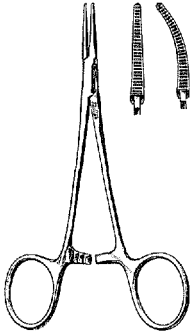

7-2
7-4

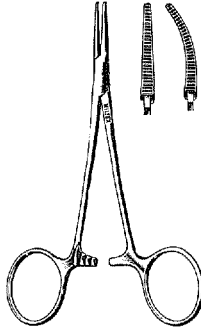

18-1934
18-1936

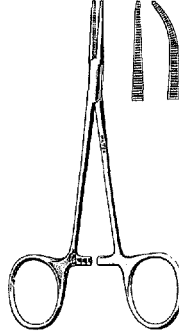

7-8
7-10

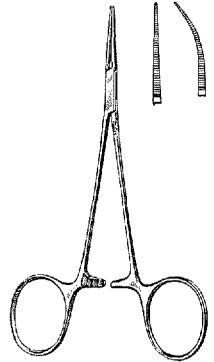

17-2600
17-2602

- 7-2 HALSTED Mosquito Forceps 5" (12.7 cm), straight
- 7-4 HALSTED Mosquito Forceps 5" (12.7 cm), curved
- 18-1934 Non-Magnetic HALSTED Mosquito Forceps 5" (12.7 cm)
- 18-1936 Non-Magnetic HALSTED Mosquito Forceps 5" (12.7 cm)
- 7-8 HALSTED Mosquito Forceps 5" (12.7 cm), straight, extra delicate
- 7-10 HALSTED Mosquito Forceps 5" (12.7 cm), curved, extra delicate
- 17-2600 JACOBSON Micro Mosquito Forceps 5" (12.7 cm), straight, extremely delicate
- 17-2602 JACOBSON Micro Mosquito Forceps 5" (12.7 cm), curved, extremely delicate
- 7-11 PACKER Mosquito Forceps 5" (12.7 cm), straight, flat jaws
- 7-12 PACKER Mosquito Forceps 5" (12.7 cm), curved, flat jaws

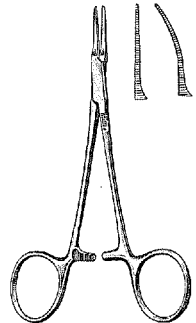

7-11
7-12

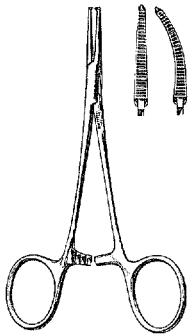

7-14
7-16

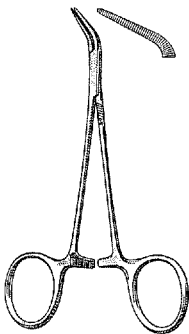

7-20

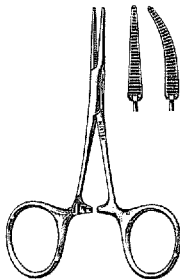

7-24
7-26

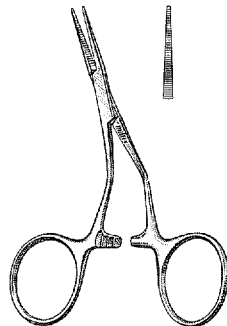

7-24A

- 7-14 HALSTED Mosquito Forceps 5" (12.7 cm), straight, 1 x 2 teeth
- 7-16 HALSTED Mosquito Forceps 5" (12.7 cm), curved, 1 x 2 teeth
- 7-20 HALSTED Mosquito Forceps 5" (12.7 cm), jaws 45° angled on flat, extra delicate
- 7-24 HARTMAN Mosquito Forceps 3½" (8.9 cm), straight
- 7-26 HARTMAN Mosquito Forceps 3½" (8.9 cm), curved
- 7-24A HARTMAN LEE Mosquito Forceps 3½" (8.9 cm), straight jaws, shanks angled on flat
- 7-30 PROVIDENCE HOSPITAL Forceps 5½" (14 cm), straight
- 7-32 PROVIDENCE HOSPITAL Forceps 5½" (14 cm), curved

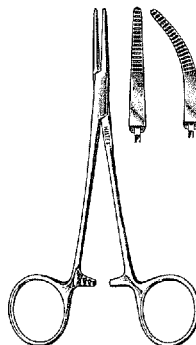

7-30
7-32

Hemostatic Forceps

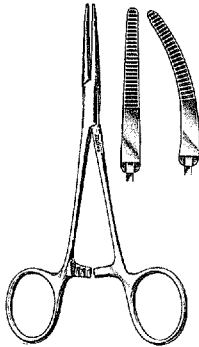

7-36
7-38

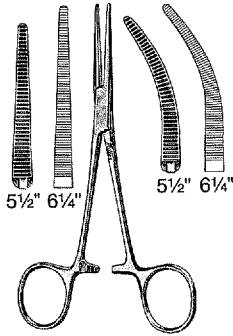

7-42 to 7-48

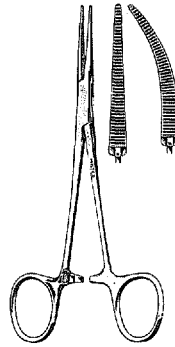

7-50
7-52

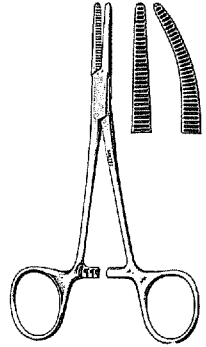

7-60
7-62

- 7-36 KELLY Forceps 5½" (14 cm), straight
- 7-38 KELLY Forceps 5½" (14 cm), curved
- 7-42 CRILE Forceps 5½" (14 cm), straight
- 7-44 CRILE Forceps 5½" (14 cm), curved
- 7-46 CRILE Forceps 6¼" (15.9 cm), straight
- 7-48 CRILE Forceps 6¼" (15.9 cm), curved
- 7-50 Baby CRILE Forceps 5½" (14 cm), straight, extra delicate
- 7-52 Baby CRILE Forceps 5½" (14 cm), curved, extra delicate
- 7-60 LAHEY Hemostatic Forceps 5½" (14 cm), straight
- 7-62 LAHEY Hemostatic Forceps 5½" (14 cm), curved
- 7-66 KOCHER Forceps 5½" (14 cm), straight, 1 x 2 teeth
- 7-68 KOCHER Forceps 5½" (14 cm), curved, 1 x 2 teeth

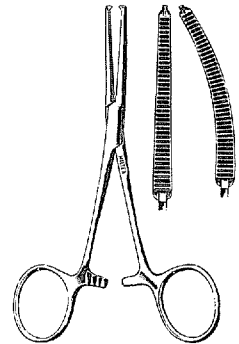

7-66
7-68



Hemostatic Forceps

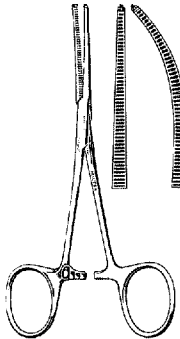

7-70
7-72

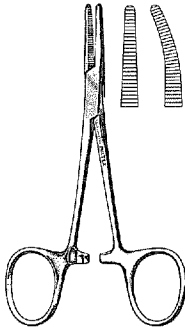

7-82
7-84

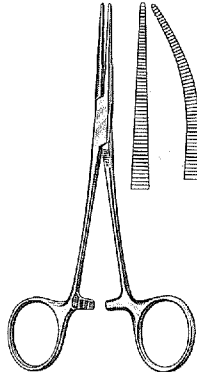

7-90
7-91

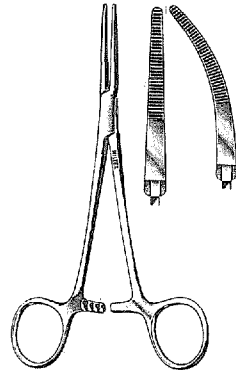

7-92
7-94

- 7-70 Baby OCHSNER Forceps 5½" (14 cm), straight, 1 x 2 teeth, extra delicate
- 7-72 Baby OCHSNER Forceps 5½" (14 cm), curved, 1 x 2 teeth, extra delicate
- 7-82 JONES Forceps 5" (12.7 cm), straight
- 7-84 JONES Forceps 5" (12.7 cm), curved
- 7-90 COLLER Forceps 6¼" (15.9 cm), straight, delicate
- 7-91 COLLER Forceps 6¼" (15.9 cm), curved, delicate
- 7-92 RANKIN Forceps 6¼" (15.9 cm), straight
- 7-94 RANKIN Forceps 6¼" (15.9 cm), curved
- 7-98 LOVELACE Hemostatic Forceps 6¼" (15.9 cm), straight, cross serrations, 1 x 2 teeth

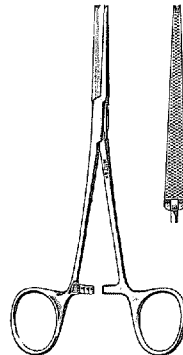

7-98

Hemostatic Forceps

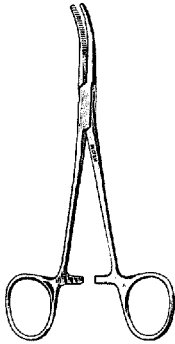

7-102

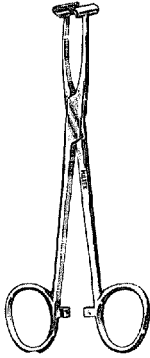

7-106

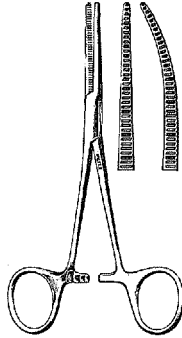

7-110
7-112

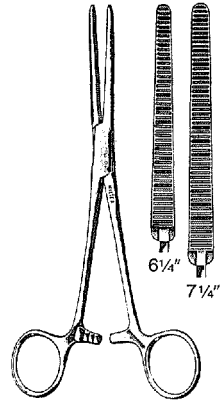

7-118 to 7-130

- 7-102 DANDY Forceps 5½" (14 cm), curved sideways
- 7-106 PRATT T-Shape Forceps 6" (15.2 cm)
- 7-110 Baby PEAN Forceps 5½" (14 cm), straight, extra delicate
- 7-112 Baby PEAN Forceps 5½" (14 cm), curved, extra delicate

ROCHESTER PEAN FORCEPS

Straight	Length	Curved
7-118	5½" (14 cm)	7-136
7-120	6¼" (15.9 cm)	7-138
7-122	7¼" (18.4 cm)	7-140
7-124	8" (20.3 cm)	7-142
7-126	9" (22.9 cm)	7-144
7-128	10¼" (26 cm)	7-146
7-130	12" (30.5 cm)	7-148

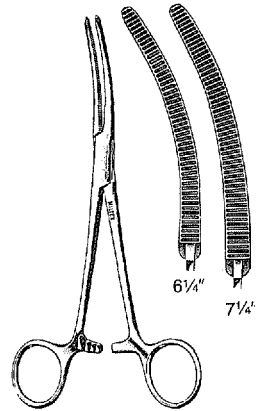

7-136 to 7-148



Hemostatic Forceps

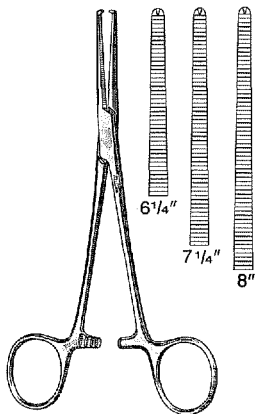

7-150 to 7-157

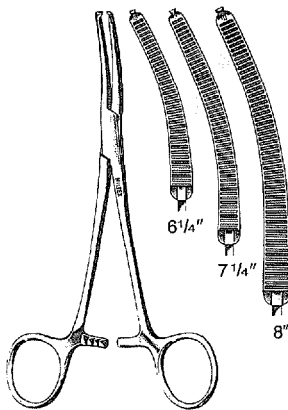

7-160 to 7-167

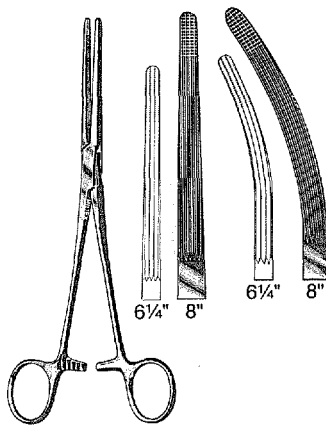

7-170 to 7-182

ROCHESTER OCHSNER FORCEPS, 1 x 2 TEETH

Straight	Length	Curved
7-150	6 1/4" (15.9 cm)	7-160
7-152	7 1/4" (18.4 cm)	7-162
7-154	8" (20.3 cm)	7-164
7-156	9" (22.9 cm)	7-166
7-157	10" (25.4 cm)	7-167

7-170 ROCHESTER CARMALT Forceps 6 1/4" (15.9 cm), straight

7-172 ROCHESTER CARMALT Forceps 6 1/4" (15.9 cm), curved

7-180 ROCHESTER CARMALT Forceps 8" (20.3 cm), straight

7-182 ROCHESTER CARMALT Forceps 8" (20.3 cm), straight

7-190 MICULICZ Hemostatic Forceps 8" (20.3 cm), slightly curved, 1 x 2 teeth

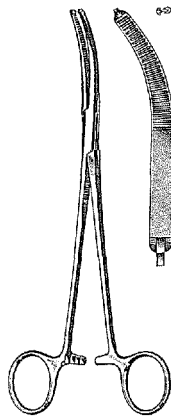

7-190

Hemostatic Forceps

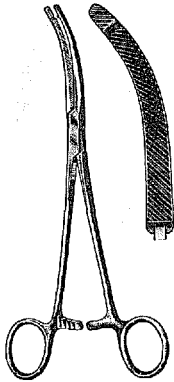

30-1700

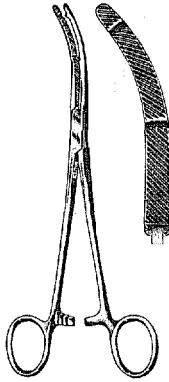

30-1710
30-1715

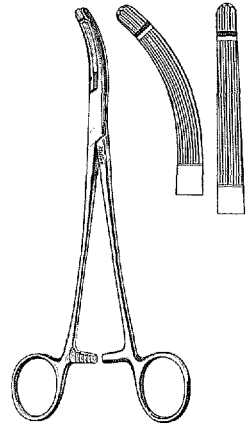

30-1716
30-1718

- 30-1700 HEANEY Forceps 8 $\frac{1}{4}$ " (21 cm), heavy pattern, single tooth, curved
- 30-1710 HEANEY Forceps 8 $\frac{1}{4}$ " (21 cm), heavy pattern, double tooth, curved
- 30-1715 HEANEY Forceps 9 $\frac{1}{4}$ " (24.8 cm), extra heavy pattern, double tooth, curved
- 30-1716 HEANEY-BALLENTINE Forceps 8 $\frac{1}{4}$ " (21 cm), longitudinal serrations, single tooth, curved
- 30-1718 BALLENTINE Forceps 8 $\frac{1}{2}$ " (21.6 cm), longitudinal serrations, single tooth, straight
- 30-1720 GARLAND Forceps 8 $\frac{1}{4}$ " (21 cm), longitudinal serrations, single tooth, angled on flat

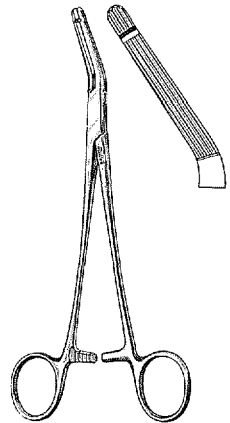

30-1720



Hemostatic Forceps

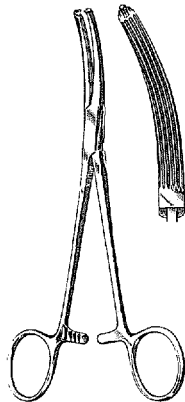

30-1730

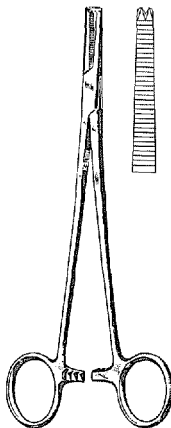

30-1735

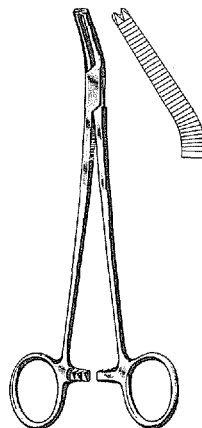

30-1740

- 30-1730 LONG Forceps 7½" (19.1 cm), longitudinal serrations, 1 x 2 teeth, curved
- 30-1735 PHANEUF Forceps 8" (20.3 cm), horizontal serrated jaws, 1 x 2 teeth, straight
- 30-1740 PHANEUF Forceps 8" (20.3 cm), horizontal serrated jaws, 1 x 2 teeth, angled on flat
- 30-1805 PEAN Forceps 9" (22.9 cm), curved, with longitudinal serrations
- 30-1815 PEAN Forceps 10¼" (26 cm), curved, with longitudinal serrations

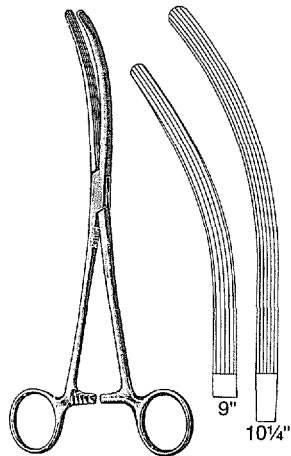

30-1805
30-1815

Hemostatic Forceps

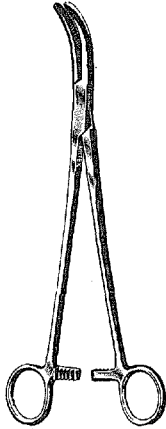

29-280

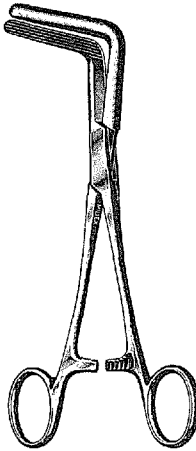

29-282

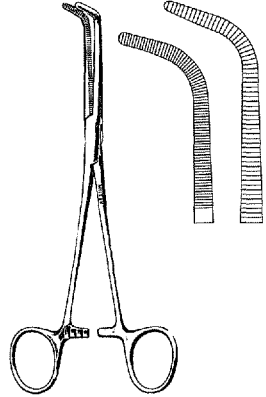

7-200
7-202

29-280 WERTHEIM Pedicle Clamp 9¾" (24.8 cm),
curved jaws 2" (5.1 cm) long

29-282 WERTHEIM-CULLEN Pedicle Clamp 8½" (21.6 cm),
right angle jaws 2" (5.1 cm) long

7-200 MIXTER Forceps 6¼" (15.9 cm), fully curved

7-202 MIXTER Forceps 7¼" (18.4 cm), fully curved

7-206 MIXTER Forceps 9" (22.9 cm), fully curved

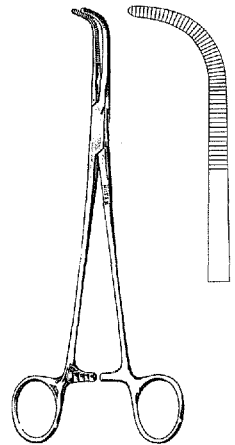

7-206



Hemostatic Forceps

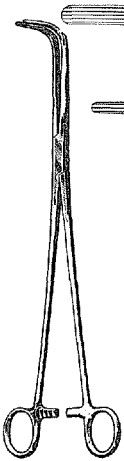

25-812
25-814

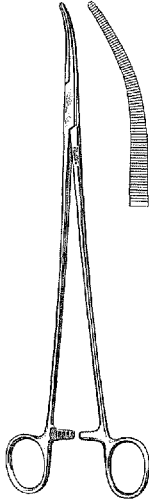

25-821

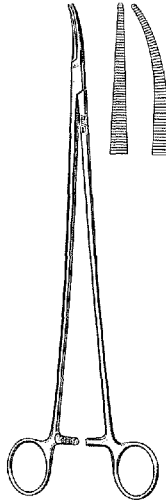

25-834
25-835

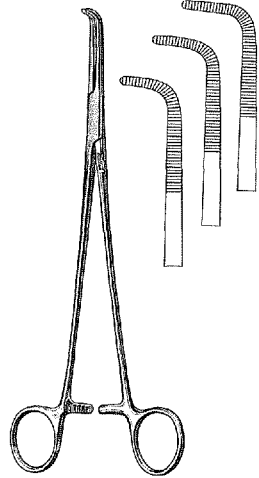

25-836 to 25-838

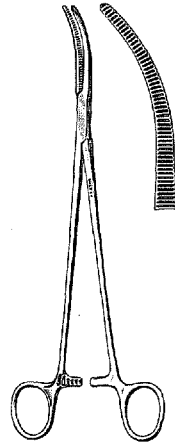

25-840

- 25-812** MIXTER Forceps 9" (22.9 cm), right angle jaws, longitudinal serrations
- 25-814** MIXTER Forceps 11" (27.9 cm), right angle jaws, longitudinal serrations
- 25-821** MILTEX Forceps 11" (27.9 cm), a delicate light-weight instrument with fine serrated 45 mm long jaws
- 25-834** BRIDGE Forceps 11" (27.9 cm), straight, very delicate
- 25-835** BRIDGE Forceps 11" (27.9 cm), curved, very delicate
- 25-836** KANTROWITZ Forceps 7½" (19.1 cm), delicate right angle jaws
- 25-837** KANTROWITZ Forceps 9½" (24.1 cm), delicate right angle jaws
- 25-838** KANTROWITZ Forceps 11" (27.9 cm), delicate right angle jaws
- 25-840** FINOCHIETTO Forceps 9" (22.9 cm), slightly curved jaws

Hemostatic Forceps

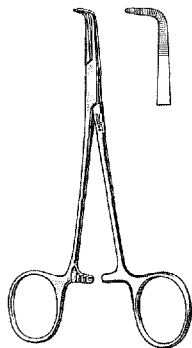

7-210

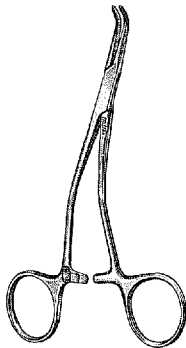

7-210A

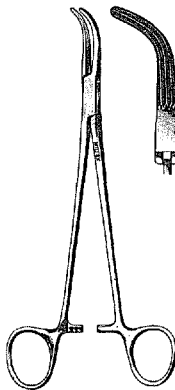

14-46

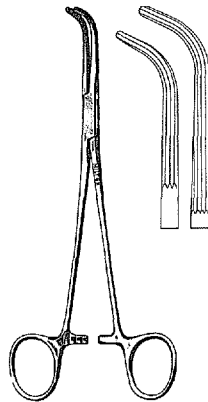

14-48
14-49

- 7-210 Baby MIXTER Forceps 5¼" (13.3 cm), fully curved, extra delicate
- 7-210A MIXTER Forceps, Lee modif. 5¼" (13.3 cm), curved jaws and angled shanks, delicate
- 14-46 LOWER Forceps 7" (17.8 cm)
- 14-48 LAHEY Forceps 7½" (19.1 cm)
- 14-49 LAHEY Forceps 9" (22.9 cm)
- 14-50 MOYNIHAN Forceps 8½" (21.6 cm)

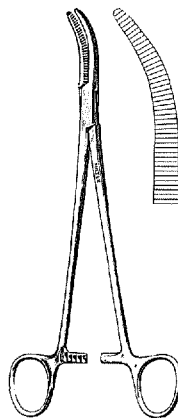

14-50

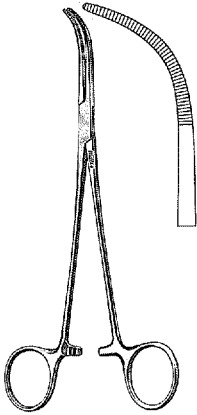

14-51

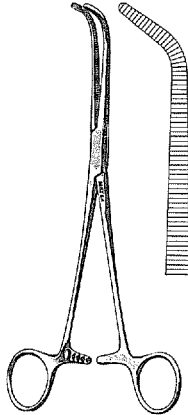

14-52

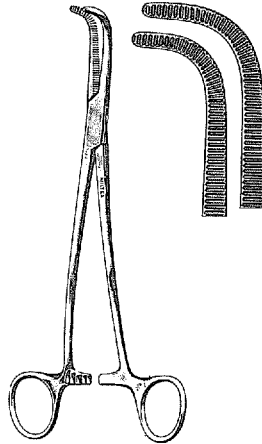

14-56

- 14-51 GREEN Forceps 8½" (21.6 cm), delicate
- 14-52 JOHNS HOPKINS Forceps 8" (20.3 cm)
- 14-56 GRAY Forceps 9" (22.9 cm), serrated, set of two
- 14-62 SHALLCROSS Forceps 7" (17.8 cm)

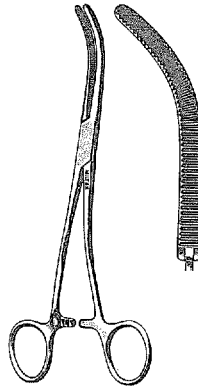

14-62

Hemostatic Forceps

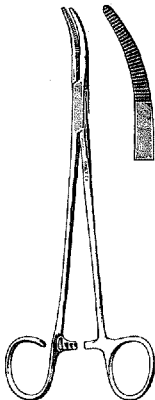

22-660

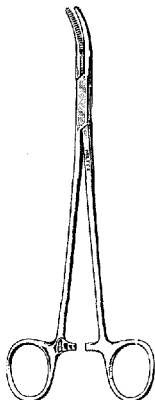

22-662

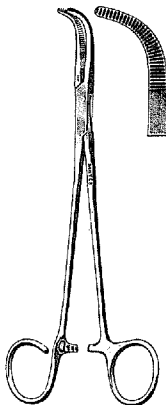

22-666

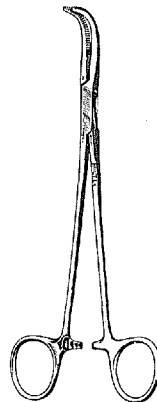

22-668

- 22-660 SCHNIDT Hemostatic Forceps 7½" (19.1 cm), slight curve, open ring
- 22-662 SCHNIDT Hemostatic Forceps 7½" (19.1 cm), slight curve, closed rings
- 22-666 SAWTELL Hemostatic Forceps 7½" (19.1 cm), full curve, open ring
- 22-668 SAWTELL Hemostatic Forceps 7½" (19.1 cm), full curve, closed rings
- 7-220 PENNINGTON Hemostatic Forceps 6" (15.2 cm)

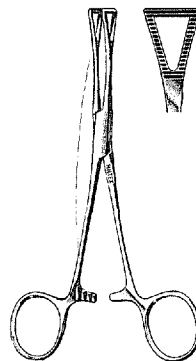

7-220

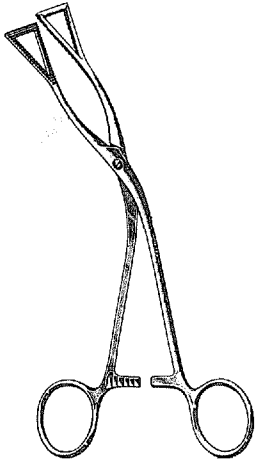

14-66

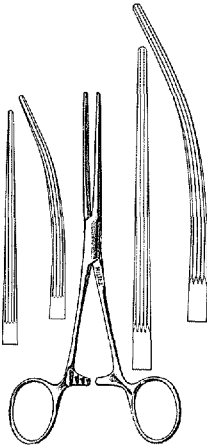

7-230 to 7-236

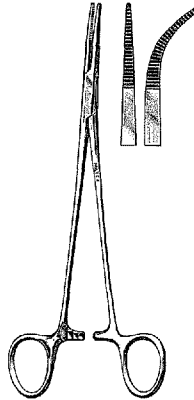

7-240
7-242

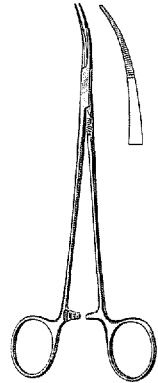

17-2603

- 14-66 LOVELACE Gall Bladder Forceps 7¼" (18.4 cm), angular, 1" (2.5 cm) wide jaws
- 7-230 BAINBRIDGE Forceps 6" (15.2 cm), straight, longitudinal serrations with cross tip serrations
- 7-232 BAINBRIDGE Forceps 6" (15.2 cm), curved, longitudinal serrations with cross tip serrations
- 7-234 BAINBRIDGE Forceps 7¼" (18.4 cm), straight, longitudinal serrations with cross tip serrations
- 7-236 BAINBRIDGE Forceps 7¼" (18.4cm), curved, longitudinal serrations with cross tip serrations
- 7-240 ADSON Hemostatic Forceps 7¼" (18.4 cm), straight
- 7-242 ADSON Hemostatic Forceps 7¼" (18.4 cm), curved
- 17-2603 JACOBSON Hemostatic Forceps 7" (17.8 cm), curved, extremely delicate
- 7-250 MOSQUITO Hemostatic Forceps 8¼" (21cm), straight, delicate
- 7-252 MOSQUITO Hemostatic Forceps 8¼" (21cm), curved, delicate
- 7-254 MOSQUITO Hemostatic Forceps 8¼" (21cm), right angle, delicate

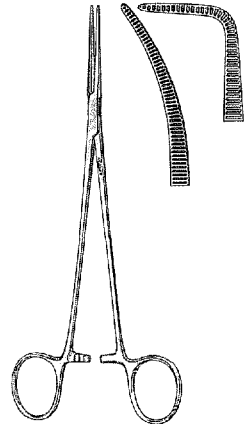

7-250 to 7-254

Hemostatic Forceps

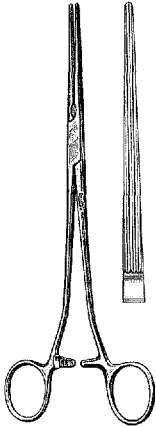

16-99

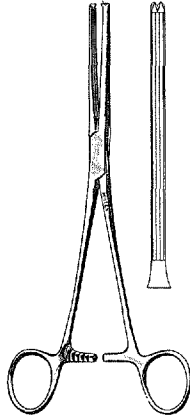

16-100

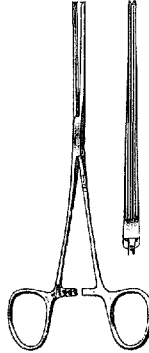

16-102

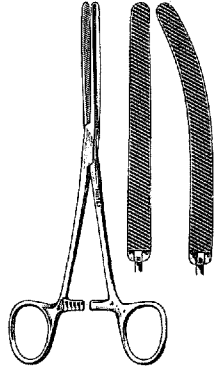

16-108
16-110

- 16-99 DENNIS Clamp 9" (22.9 cm), longitudinal serrations
- 16-100 ALLEN Clamp 8" (20.3 cm), longitudinal serrations with 1 x 2 teeth
- 16-102 Baby ALLEN Clamp 6½" (16.5 cm), delicate, longitudinal serrations with 1 x 2 teeth
- 16-108 Baby DOYEN Forceps 6½" (16.5 cm), straight, flexible blades with diagonal serrations
- 16-110 Baby DOYEN Forceps 6½" (16.5 cm), curved, flexible blades with diagonal serrations
- 16-120 KOCHER Forceps 10½" (26.7 cm), straight, longitudinal serrations
- 16-122 KOCHER Forceps 10½" (26.7 cm), curved, longitudinal serrations

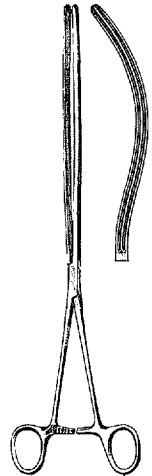

16-120
16-122

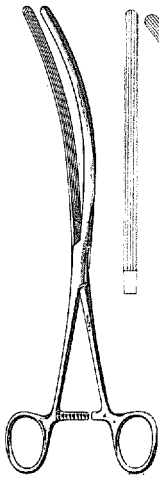

16-130
16-132

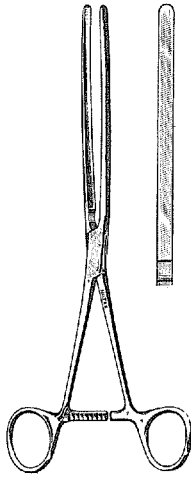

16-140

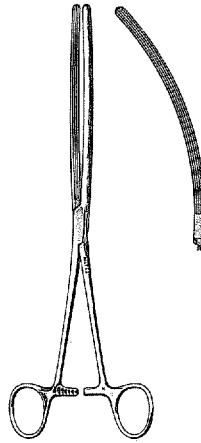

16-160
16-162

- 16-130 MAYO-ROBSON Forceps 10" (25.4 cm), straight, longitudinal serrations
- 16-132 MAYO-ROBSON Forceps 10" (25.4 cm), curved, longitudinal serrations
- 16-140 SCUDDER Forceps 9½" (24.1 cm), straight, smooth solid blades
- 16-160 DOYEN Forceps 9" (22.9 cm), straight, flexible blades with longitudinal serrations
- 16-162 DOYEN Forceps 9" (22.9 cm), curved, flexible blades with longitudinal serrations
- 7-255 GEMINI-MIXTER Forceps 5½" (14 cm), delicate, full curved jaws
- 7-256 GEMINI-MIXTER Forceps 7" (17.8 cm), delicate, full curved jaws
- 7-257 GEMINI-MIXTER Forceps 8" (20.3 cm), delicate, full curved jaws
- 7-258 GEMINI-MIXTER Forceps 9" (22.9 cm), delicate, full curved jaws
- 7-259 GEMINI-MIXTER Forceps 11" (27.9 cm), delicate, full curved jaws

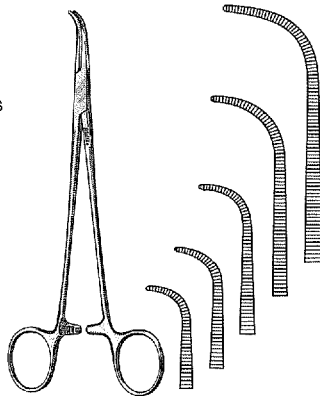

7-255 to 7-259

Hemostatic Forceps

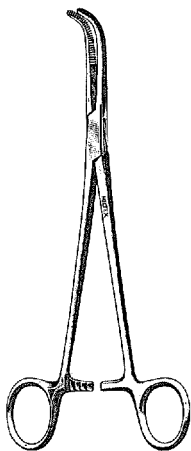

25-780 to 25-786

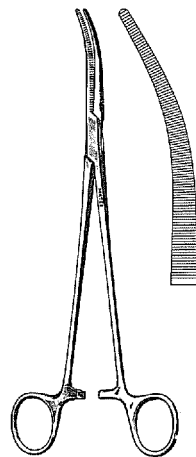
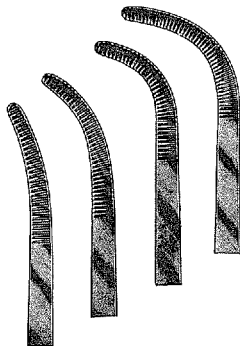

25-800

- 25-780 RUMEL Forceps 9" (22.9 cm), slight curve, 2 $\frac{3}{8}$ " (6.1 cm), long jaws
- 25-782 RUMEL Forceps 9" (22.9 cm), medium curve, 2 $\frac{3}{8}$ " (6.1 cm), long jaws
- 25-784 RUMEL Forceps 9" (22.9 cm), full curve, 2 $\frac{3}{8}$ " (6.1 cm), long jaws
- 25-786 RUMEL Forceps 9" (22.9 cm), angular, 2 $\frac{3}{8}$ " (6.1 cm), long jaws
- 25-800 SAROT Artery Forceps 9 $\frac{1}{2}$ " (24.1 cm), with 2 $\frac{1}{2}$ " (6.4 cm) long jaws

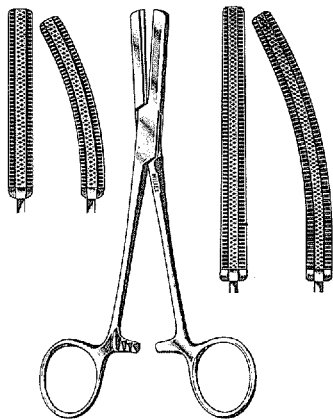

7-260 to 7-266

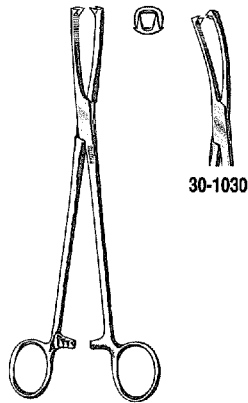

30-1025

- 7-260 FERGUSON Angiotribe Forceps 6½" (16.5 cm), straight
- 7-262 FERGUSON Angiotribe Forceps 6½" (16.5 cm), curved
- 7-264 FERGUSON Angiotribe Forceps 7½" (19.1 cm), straight
- 7-266 FERGUSON Angiotribe Forceps 7½" (19.1 cm), curved

- 30-1025 JACOBS Forceps 8½" (21.6 cm), straight, serrated jaws, 2 x 2 teeth
- 30-1030 JACOBS Forceps 8½" (21.6 cm), curved sideways, serrated jaws, 2 x 2 teeth

- 30-1050-6 MUSEUX Forceps 9½" (24.1 cm), straight, 2 x 2 teeth, 6 mm wide jaws
- 30-1050-8 MUSEUX Forceps 9½" (24.1 cm), straight, 2 x 2 teeth, 8 mm wide jaws
- 30-1050-10 MUSEUX Forceps 9½" (24.1 cm), straight, 2 x 2 teeth, 10 mm wide jaws

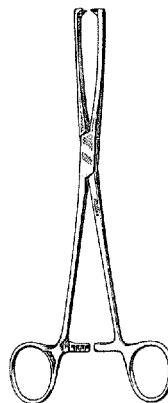

30-1050-6
30-1050-8
30-1050-10

Hemostatic Forceps



7-280 to 7-298



7-300 to 7-305



7-310



7-315

- 7-280 JOHNS HOPKINS Bulldog Clamp 1½" (3.8 cm), straight
- 7-282 JOHNS HOPKINS Bulldog Clamp 2" (5 cm), straight
- 7-284 JOHNS HOPKINS Bulldog Clamp 2½" (6.3 cm), straight
- 7-286 JOHNS HOPKINS Bulldog Clamp 3" (7.6 cm), straight
- 7-288 JOHNS HOPKINS Bulldog Clamp 3½" (8.9 cm), straight
- 7-290 JOHNS HOPKINS Bulldog Clamp 1½" (3.8 cm), curved
- 7-292 JOHNS HOPKINS Bulldog Clamp 2" (5 cm), curved
- 7-294 JOHNS HOPKINS Bulldog Clamp 2½" (6.3 cm), curved
- 7-296 JOHNS HOPKINS Bulldog Clamp 3" (7.6 cm), curved
- 7-298 JOHNS HOPKINS Bulldog Clamp 3½" (8.9 cm), curved

- 7-300 DIEFFENBACH Serrefine 2¼" (5.7 cm), straight
- 7-302 DIEFFENBACH Serrefine 2¼" (5.7 cm), curved
- 7-304 DIEFFENBACH Serrefine 1½" (3.8 cm), straight
- 7-305 DIEFFENBACH Serrefine 1½" (3.8 cm), curved

- 7-310 DIETHRICH Micro Bulldog Clamp 1¾" (4.7 cm), straight jaws
8 mm x 1.2 mm
- 7-315 DIETHRICH Micro Bulldog Clamp 1¾" (4.4 cm), angled jaws
8 mm x 1.2 mm

For Atraumatic Bulldog clamps see pages 374 - 376



Towel Clamps



7-500
7-501

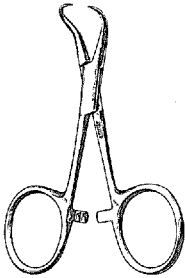

7-504

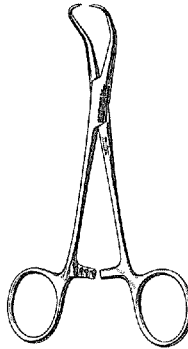

7-506

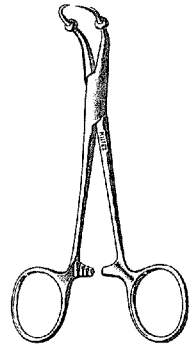

7-510

- 7-500 JONES Towel Clamp 3½" (8.9 cm), standard size
- 7-501 JONES Towel Clamp 2¼" (5.7 cm), lightweight
- 7-504 BACKHAUS Towel Clamp 3½" (8.9 cm)
- 7-506 BACKHAUS Towel Clamp 5¼" (13.3 cm)
- 7-510 ROEDER Towel Clamp 5¼" (13.3 cm), with ball stops
- 7-514 LORNA Non-Perforating Towel Clamp 3½" (8.9 cm)
- 7-515 LORNA Non-Perforating Towel Clamp 5¼" (13.3 cm)

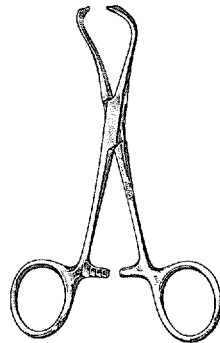

7-514
7-515

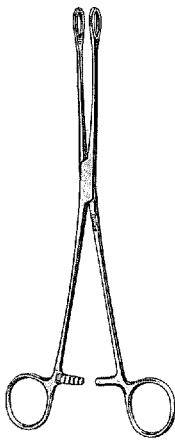

7-600 to 7-606

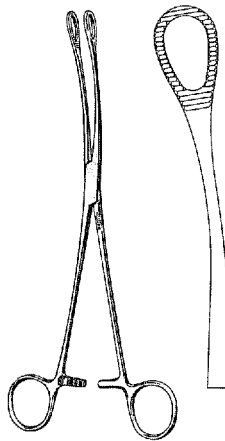

7-610 to 7-616

FOERSTER SPONGE FORCEPS

- | | |
|----------------|---|
| 7-600 | 9½" (24.1 cm), straight, serrated jaws |
| 7-602 | 9½" (24.1 cm), straight, smooth jaws |
| 7-604 | 7" (17.8 cm), straight, serrated jaws |
| 7-606 | 7" (17.8 cm), straight, smooth jaws |
| 7-610 | 9½" (24.1 cm), curved, serrated jaws |
| 7-612 | 9½" (24.1 cm), curved, smooth jaws |
| 7-614 | 7" (17.8 cm), curved, serrated jaws |
| 7-616 | 7" (17.8 cm), curved, smooth jaws |
| 30-2505 | KELLY Sponge Forceps 12½" (31.8 cm), serrated ring jaws, slightly curved |

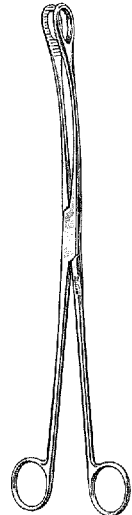

30-2505

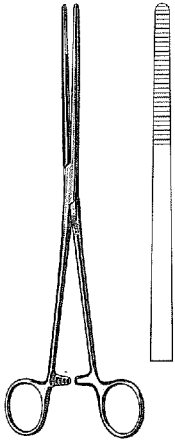

7-620

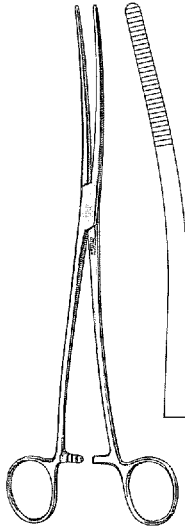

7-622

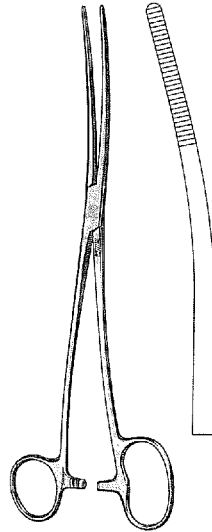

7-624

- 7-620 BOZEMAN Sponge Forceps 10½" (26.7 cm), straight
- 7-622 BOZEMAN Sponge Forceps 10½" (26.7 cm), double curved
- 7-624 BOZEMAN Sponge Forceps 10½" (26.7 cm), double curved, with one large finger ring

- 7-630 FLETCHER Sponge Forceps 9½" (24.1 cm), straight
- 7-632 FLETCHER Sponge Forceps 9½" (24.1 cm), curved

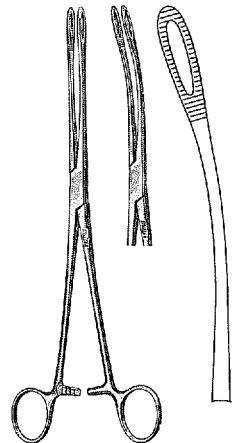

7-630
7-632

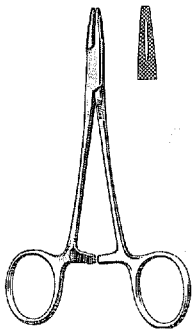

8-2

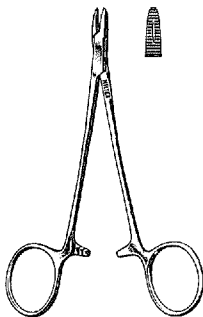

8-4

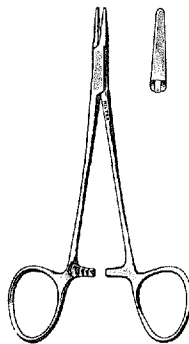

8-6

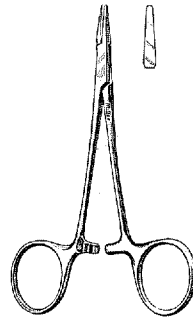

8-7

- 8-2 COLLIER Needle Holder 5" (12.7 cm), fenestrated jaws
- 8-4 DERF Needle Holder 4¾" (12.1 cm)
- 8-6 WEBSTER Needle Holder 5" (12.7 cm), delicate, smooth jaws, standard pattern
- 8-7 WEBSTER Needle Holder 4¾" (12.1 cm), extra delicate, smooth jaws
- 8-8 HALSEY Needle Holder 5" (12.7 cm), smooth jaws
- 8D-36 HALSEY Needle Holder 5" (12.7 cm), serrated jaws

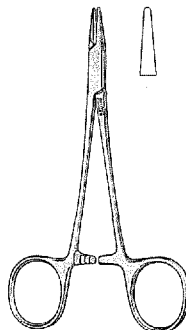

8-8

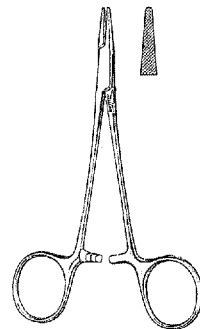

8D-36



Needle Holders

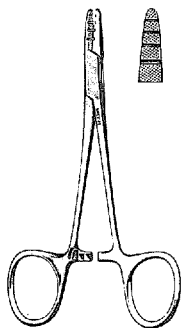

8-10

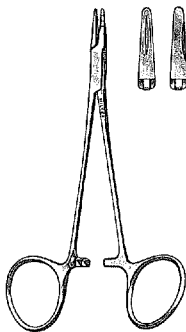

8-12

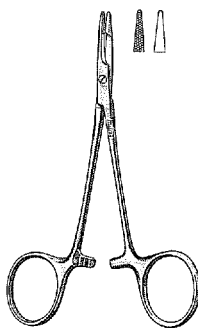

8-14
8-14A

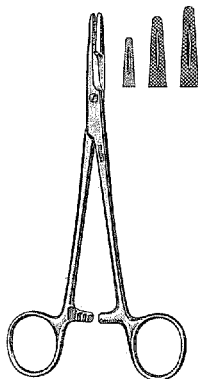

8-15 to 8-17

- 8-10 ABBEY Needle Holder 5" (12.7 cm)
- 8-12 NEIVERT Needle Holder 5" (12.7 cm), one offset ring

OLSEN-HEGAR NEEDLE HOLDERS combined with Suture Scissors

- 8-14 4¾" (12.1 cm), extra delicate pattern, serrated jaws
- 8-14A 4¾" (12.1 cm), extra delicate pattern, smooth jaws
- 8-15 5½" (14 cm), serrated jaws
- 8-16 6½" (16.5 cm), serrated jaws
- 8-17 7¼" (18.4 cm), serrated jaws
- 8-20 CONVERSE Needle Holder 4¾" (10.8 cm), longitudinal serrations, large finger rings

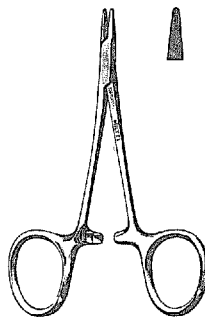

8-20

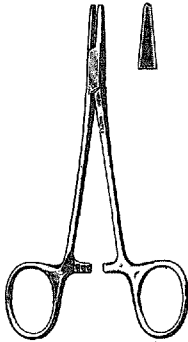

8-22
8-23

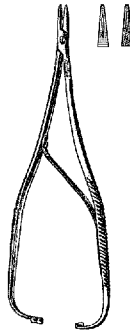

8-26

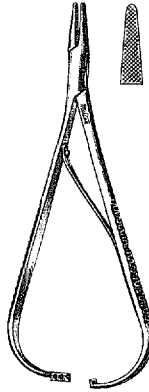

8-28

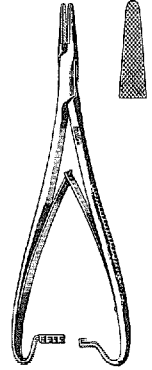

8-30
8-32

- 8-22 BROWN Needle Holder 5¼" (13.3 cm), convex jaws, fine serrations
- 8-23 BROWN Needle Holder 6¾" (17.1 cm), convex jaws, fine serrations
- 8-26 BOYNTON Needle Holder 5" (12.7 cm), delicate
- 8-28 MATHIEU Needle Holder 5½" (14 cm), with spring handles
- 8-30 MATHIEU Needle Holder 6¼" (15.9 cm), with spring handles
- 8-32 MATHIEU Needle Holder 7½" (19.1 cm), with spring handles
- 8-40 BAUMGARTNER Needle Holder 5½" (14 cm)

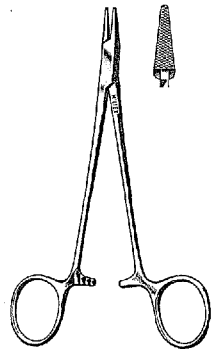

8-40

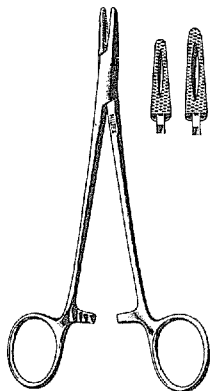

8-42 to 8-48

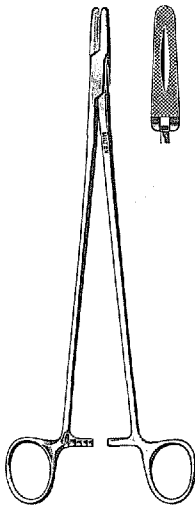

8-130

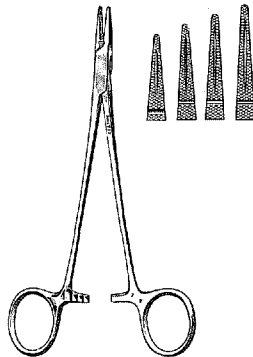

8-50 to 8-53

- 8-42 MAYO-HEGAR Needle Holder 5" (12.7 cm)
- 8-44 MAYO-HEGAR Needle Holder 6" (15.2 cm)
- 8-46 MAYO-HEGAR Needle Holder 7" (17.8 cm)
- 8-48 MAYO-HEGAR Needle Holder 8" (20.3 cm)
- 8-130 MAYO-HEGAR (MASSON) Needle Holder 10½" (26.7 cm)

- 8-50 CRILE-WOOD Needle Holder 6" (15.2 cm)
- 8-51 CRILE-WOOD Needle Holder 7" (17.8 cm)
- 8-52 CRILE-WOOD Needle Holder 8" (20.3 cm)
- 8-53 CRILE-WOOD Needle Holder 9" (22.9 cm)

GILLIES-SHEEHAN Needle Holders combined with Suture Scissors, one fenestrated jaw and one angled finger ring

- 8-58 6½" (16.5 cm), straight
- 8-59 6½" (16.5 cm), curved

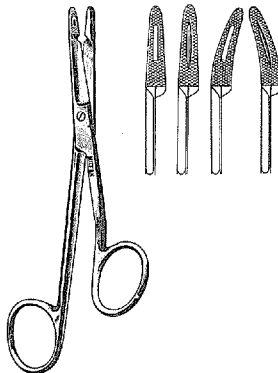

8-58
8-59

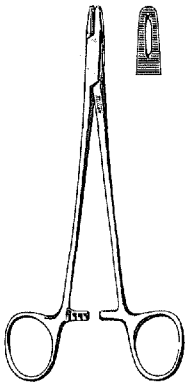

8-70

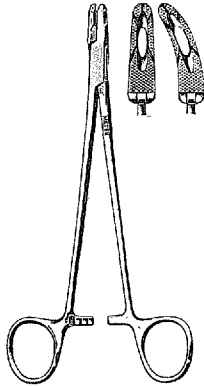

8-74
8-76

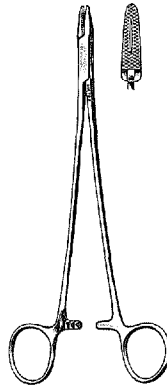

8-80

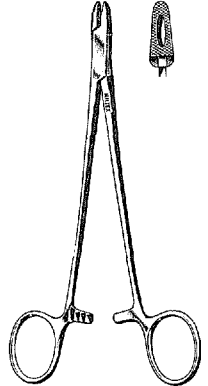

8-84

- 8-70 ADSON Needle Holder 7" (17.8 cm), fenestrated jaws
- 8-74 METZENBAUM Needle Holder 7¼" (18.4 cm), straight, fenestrated jaws
- 8-76 METZENBAUM Needle Holder 7¼" (18.4 cm), curved, fenestrated jaws
- 8-80 NEW ORLEANS Needle Holder 7" (17.8 cm)
- 8-84 M.G.H. Needle Holder 7" (17.8 cm)
- 8-94 CRILE Needle Holder 6" (15.2 cm)

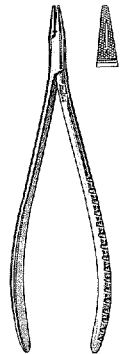

8-94



Needle Holders

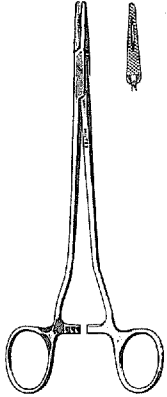

8-96

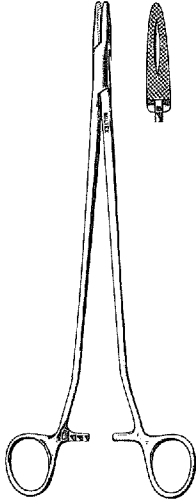

8-114

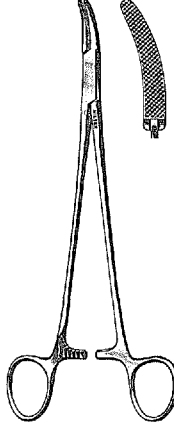

8-100

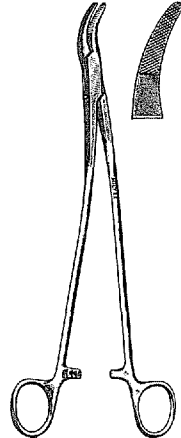

8-102

- 8-96 SAROT Needle Holder 7½" (18.1 cm), light model
- 8-114 SAROT Needle Holder 10½" (26.7 cm)
- 8-100 HEANEY Needle Holder 8½" (21.6 cm), curved jaws
- 8-102 STRATTE Needle Holder 9" (22.9 cm), double curved jaws and bent shanks

Needle Holders

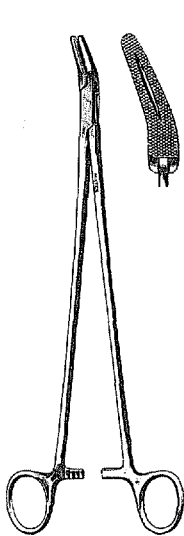

8-122

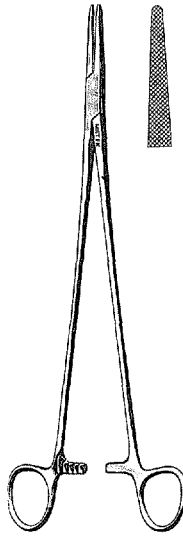

8-134

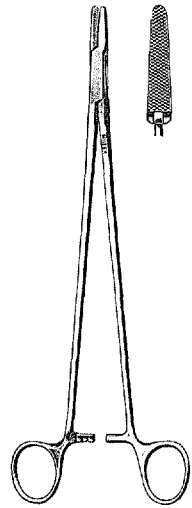

8-136

- 8-122 FINOCHIETTO Needle Holder 10½" (26.7 cm), angled jaws
- 8-134 WANGENSTEEN Needle Holder 10¾" (27.3 cm), long jaws
- 8-136 WANGENSTEEN Needle Holder 10½" (26.7 cm), short jaws



Needle Holders

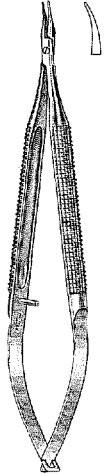

17-1000

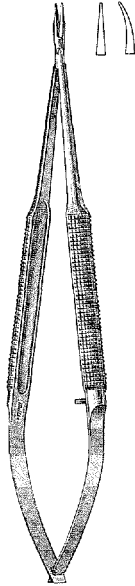

17-980
17-1010

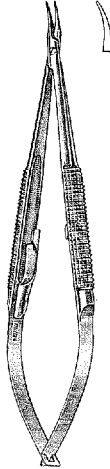

17-1020

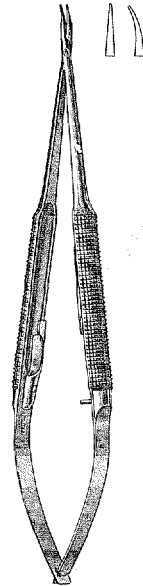

17-1024
17-1025

MILTEX Micro Surgery Needle Holders with round handles, 0.6 mm tips

- | | |
|---------|---|
| 17-1000 | 5¼" (13.3 cm), curved jaws |
| 17-980 | 7⅞" (18.1 cm), straight jaws |
| 17-1010 | 7⅞" (18.1 cm), curved jaws |
| 17-1020 | 5¼" (13.3 cm), curved jaws, with lock |
| 17-1024 | 7⅞" (18.1 cm), straight jaws, with lock |
| 17-1025 | 7⅞" (18.1 cm), curved jaws, with lock |

Needle Holders

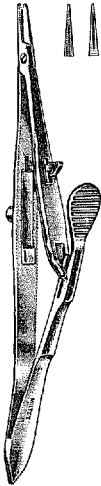

18-1800

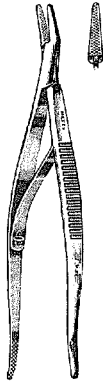

18-1810

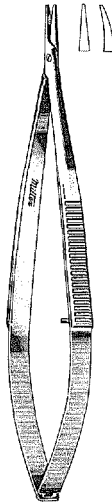

18-1820
18-1824

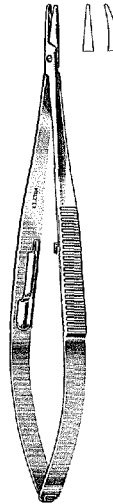

18-1828
18-1832

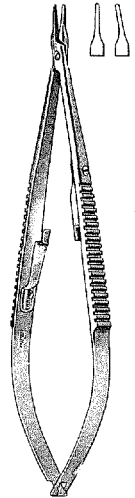

18-1831
18-1833

- 18-1800 KALT Needle Holder 5¼" (13.3 cm), standard model, delicate jaws
- 18-1810 GREEN Needle Holder and Suturing Forceps 4¼" (10.8 cm), angled jaws, double end
- 18-1820 CASTROVIEJO Needle Holder 5½" (14 cm), straight, without lock
- 18-1824 CASTROVIEJO Needle Holder 5½" (14 cm), curved, without lock
- 18-1828 CASTROVIEJO Needle Holder 5½" (14 cm), straight, with lock
- 18-1832 CASTROVIEJO Needle Holder 5½" (14 cm), curved, with lock
- 18-1831 CASTROVIEJO Needle Holder 5½" (14 cm), straight, extra delicate jaws, with lock
- 18-1833 CASTROVIEJO Needle Holder 5½" (14 cm), curved, extra delicate jaws, with lock

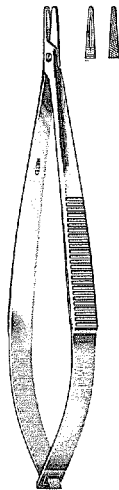

18-1834

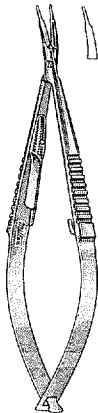

18-1837

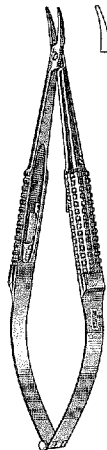

18-1838
18-1839

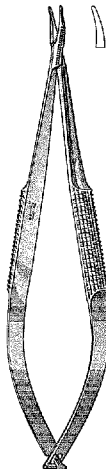

18-1840



18-1858

- 18-1834 PATON Needle Holder 4½" (11.4 cm), straight, without lock
- 18-1837 McPHERSON Needle Holder for microsurgery 4" (10.2 cm), curved, smooth tapered jaws, with lock
- 18-1838 BARRAQUER Needle Holder 5" (12.7 cm), curved, without lock, 10 mm wide hollow round handles
- 18-1839 BARRAQUER Needle Holder 5" (12.7cm), curved, with lock, 10 mm wide hollow round handles
- 18-1840 BARRAQUER Needle Holder 5½" (13 cm), curved, delicate tapered jaws, 8 mm wide round handles, without lock
- 18-1858 STEVENS Needle Holder 6½" (16.5 cm), with ratchet lock

Carb-N-Sert Needle Holders



OUR TOP QUALITY LINE OF NEEDLE HOLDERS

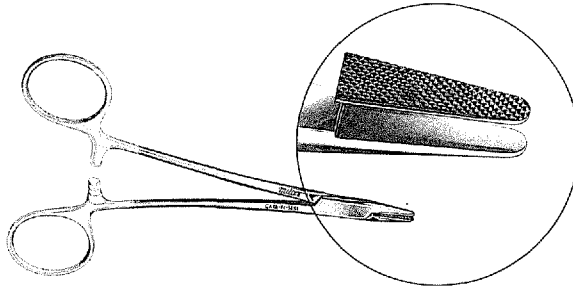

Carb-N-Sert jaws are made of tungsten carbide, the hardest steel made for surgical instruments. They are then bonded to needle holders made of the finest quality stainless steel.

- Teeth are precision milled into the tungsten carbide, forming sharp pyramid-shapes to provide a positive non-slip grip on needles and sutures.
- Carb-N-Sert jaws are custom styled with teeth ranging from 2600 p.sq. inch to 16000 p.sq. inch, according to the size of the instrument and the sizes of needles and sutures used. Some needle holder patterns are also available with smooth Carb-N-Sert jaws, designed to hold the smallest sutures in micro-surgical and plastic surgery procedures.
- The edges around the outside of the jaws are chamfered to prevent

accidental cutting of suture material when held in the jaws.

- The edges around the box lock have distinct non-catch bevels, preventing fraying of suture material.
- Finger Rings are well rounded and polished for better "feel" and prevention of finger fatigue.
- Each instrument is satin finished to reduce glare.

Gold plated finger rings identify these tungsten carbide instruments, and the Miltex catalog number has been etched on each needle holder to facilitate re-ordering.

Carb-N-Sert Needle Holders are specifically designed for precise suturing, thereby facilitating the surgeon's task.



Carb-N-Sert Needle Holders

CARB-N-SERT NEEDLE HOLDERS
with tungsten carbide inserts
insure firm holding of needles and sutures

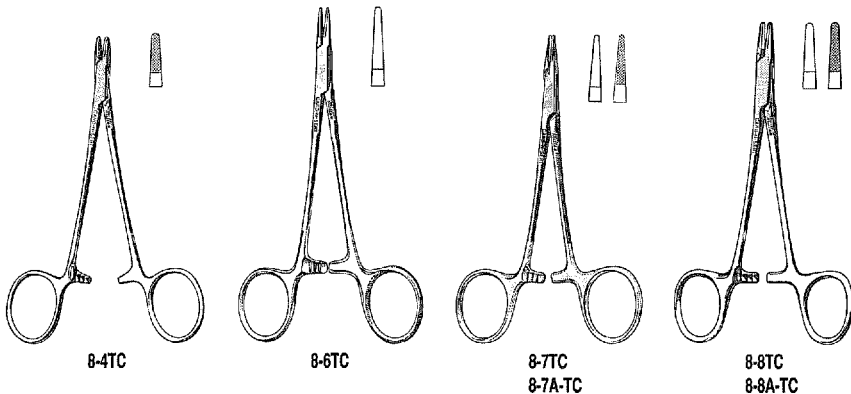

- 8-4TC** DERF Needle Holder 4 3/4" (12.1 cm), serrated jaws 4000 teeth p. sq. inch
- 8-6TC** WEBSTER Needle Holder 5 1/4" (13.3 cm), smooth jaws, standard pattern, delicate
- 8-7TC** WEBSTER Needle Holder 4 3/4" (12.1 cm), smooth jaws, extra delicate
- 8-7A-TC** WEBSTER (JOHNSON) Needle Holder 4 3/4" (12.1 cm), serrated jaws 4000 teeth p. sq. inch, extra delicate
- 8-8TC** HALSEY Needle Holder 5" (12.7 cm), smooth jaws, standard pattern
- 8-8A-TC** HALSEY Needle Holder 5" (12.7 cm), serrated jaws 4000 teeth p. sq. inch

Carb-N-Sert Needle Holders



CARB-N-SERT NEEDLE HOLDERS
with tungsten carbide inserts
insure firm holding of needles and sutures

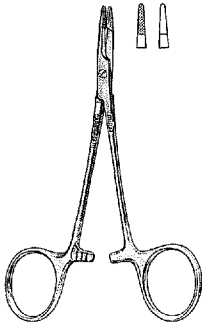

8-14TC
8-14A-TC

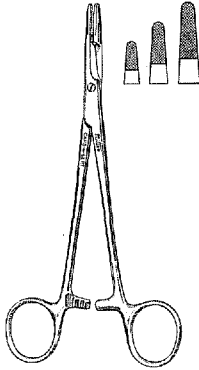

8-15TC
8-16TC
8-17TC

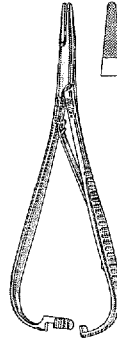

8-28TC

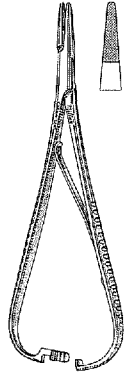

8-30TC

OLSEN-HEGAR NEEDLE HOLDERS combined with Suture Scissors

- 8-14TC 4¾" (12.1 cm) extra delicate, serrated jaws
4000 teeth p. sq. inch
- 8-14A-TC 4¾" (12.1 cm), extra delicate, smooth jaws
- 8-15TC 5½" (14 cm) serrated jaws 2600 teeth p. sq. inch
- 8-16TC 6½" (16.5 cm) serrated jaws 2600 teeth p. sq. inch
- 8-17TC 7½" (19.1 cm) serrated jaws 2600 teeth p. sq. inch
- 8-28TC MATHIEU Needle Holder 5½" (14 cm), serrated jaws
2600 teeth p. sq. inch
- 8-30TC MATHIEU Needle Holder 6¼" (15.9 cm), serrated jaws
2600 teeth p. sq. inch
- 8-40TC BAUMGARTNER Needle Holder 5½" (14 cm), serrated
jaws 4000 teeth p. sq. inch

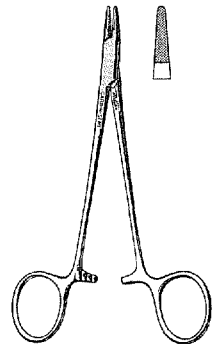

8-40TC

CARB-N-SERT NEEDLE HOLDERS
with tungsten carbide inserts
insure firm holding of needles and sutures

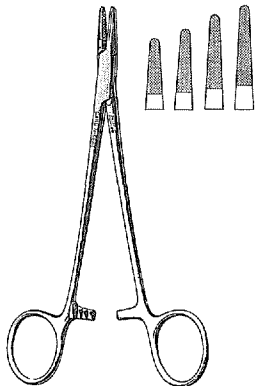

8-42TC to 8-48TC

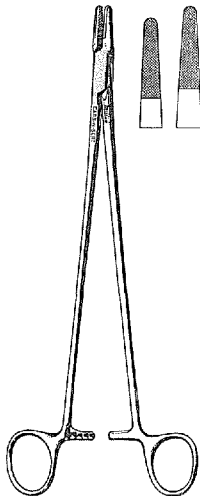

8-130TC
8-49TC

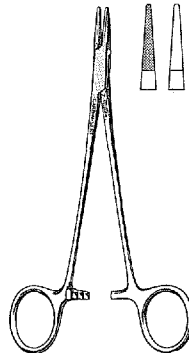

8-50TC
8-50A-TC

- 8-42TC MAYO-HEGAR Needle Holder 5" (12.7 cm), serrated jaws 2600 teeth p. sq. inch
- 8-44TC MAYO-HEGAR Needle Holder 6" (15.2 cm), serrated jaws 2600 teeth p. sq. inch
- 8-46TC MAYO-HEGAR Needle Holder 7" (17.8 cm), serrated jaws 2600 teeth p. sq. inch
- 8-48TC MAYO-HEGAR Needle Holder 8" (20.3 cm), serrated jaws 2600 teeth p. sq. inch
- 8-130TC MAYO-HEGAR (MASSON) Needle Holder 10½" (26.7 cm), serrated jaws 2600 teeth p. sq. inch
- 8-49TC MAYO-HEGAR Needle Holder 12" (30.5 cm), serrated jaws 2600 teeth p. sq. inch
- 8-50TC CRILE-WOOD Needle Holder 6" (15.2 cm), serrated jaws 4000 teeth p. sq. inch
- 8-50A-TC CRILE-WOOD Needle Holder 6" (15.2 cm), smooth jaws

Carb-N-Sert Needle Holders



CARB-N-SERT NEEDLE HOLDERS
with tungsten carbide inserts
insure firm holding of needles and sutures

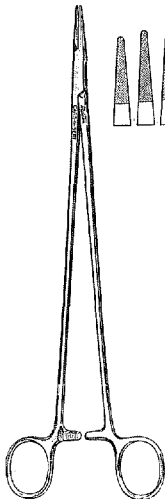

8-51TC to 8-57TC

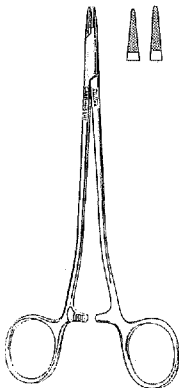

8-62TC
8-63TC

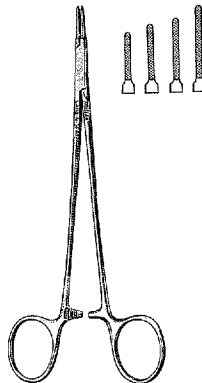

8-65TC to 8-69TC

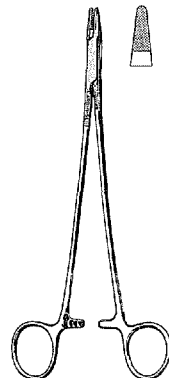

8-81TC

- 8-51TC CRILE-WOOD (DeBAKEY) Needle Holder 7" (17.8 cm), serrated jaws 4000 teeth p. sq. inch
- 8-52TC CRILE-WOOD (DeBAKEY) Needle Holder 8" (20.3 cm), serrated jaws 2600 teeth p. sq. inch
- 8-53TC CRILE-WOOD (DeBAKEY) Needle Holder 9" (22.9 cm), serrated jaws 2600 teeth p. sq. inch
- 8-55TC CRILE-WOOD (DeBAKEY) Needle Holder 10½" (26.7 cm), serrated jaws 2600 teeth p. sq. inch
- 8-57TC CRILE-WOOD (DeBAKEY) Needle Holder 12" (30.5 cm), serrated jaws 2600 teeth p. sq. inch
- 8-62TC COOLEY Needle Holder 6" (15.2 cm), extra delicate, serrated jaws 4000 teeth p. sq. inch
- 8-63TC COOLEY Needle Holder 6¾" (17.1 cm), extra delicate, serrated jaws 4000 teeth p. sq. inch
- 8-65TC RYDER-Type Intracardiac Needle Holder 5" (12.7 cm), extra delicate, serrated jaws 4000 teeth p. sq. inch
- 8-66TC RYDER-Type Intracardiac Needle Holder 6" (15.2 cm), extra delicate, serrated jaws 4000 teeth p. sq. inch
- 8-67TC RYDER-Type Intracardiac Needle Holder 7" (17.8 cm), extra delicate, serrated jaws 4000 teeth p. sq. inch
- 8-69TC RYDER-Type Intracardiac Needle Holder 9" (22.9 cm), extra delicate, serrated jaws 4000 teeth p. sq. inch
- 8-81TC NEW ORLEANS Needle Holder 7" (17.8cm), serrated jaws 2600 teeth p. sq. inch



Carb-N-Sert Needle Holders

CARB-N-SERT NEEDLE HOLDERS
with tungsten carbide inserts
insure firm holding of needles and sutures

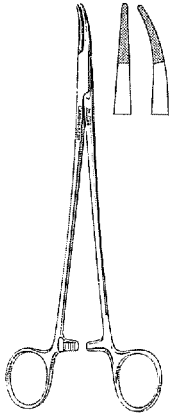

8-82TC
8-83TC

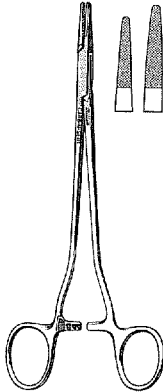

8-96TC
8-114TC

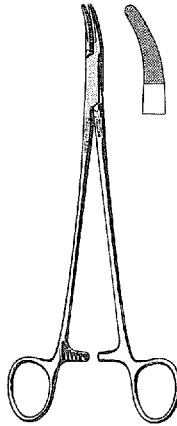

8-100TC

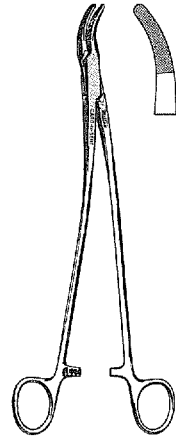

8-102TC

8-82TC JULIAN PATTERN Needle Holder 8¼" (21cm), straight fine tips, serrated jaws 2600 teeth p. sq. inch

8-83TC JULIAN PATTERN Needle Holder 8¼" (21cm), curved fine tips, serrated jaws 2600 teeth p. sq. inch

8-96TC SAROT Needle Holder 7¼" (18.4cm), serrated jaws 2600 teeth p. sq. inch

8-114TC SAROT Needle Holder 10½" (26.7cm), serrated jaws 2600 teeth p. sq. inch

8-100TC HEANEY Needle Holder 8½" (21.6 cm), curved, serrated jaws 2600 teeth p. sq. inch

8-102TC STRATTE Needle Holder 9" (22.9cm), serrated jaws 2600 teeth p. sq. inch

22-500TC Wire Twister 6" (15.2 cm)

22-502TC Wire Twister 8" (20.3 cm)

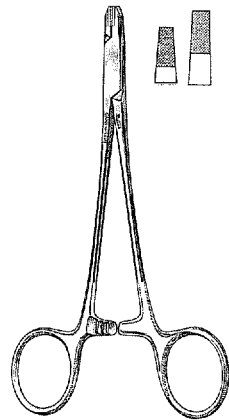

22-500TC
22-502TC

Carb-N-Sert Needle Holders



CARB-N-SERT NEEDLE HOLDERS
with tungsten carbide inserts insure firm holding of needles and sutures

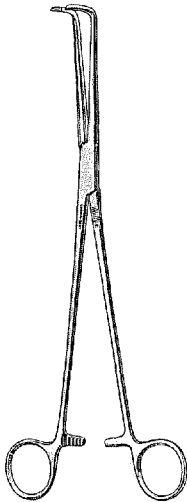

29-310TC

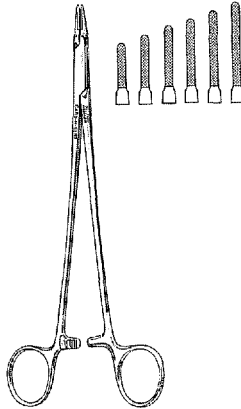

8-101TC to 107TC

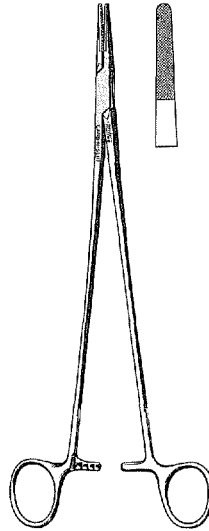

8-134TC

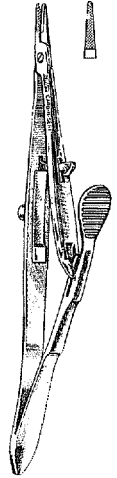

18-1800TC

29-310TC BIHRLE Needle Holder/Clamp 11" (27.9 cm)

8-101TC RYDER Needle Holder 5" (12.7 cm), serrated jaws 4000 teeth p. sq. inch

8-103TC RYDER Needle Holder 6" (15.2 cm), serrated jaws 4000 teeth p. sq. inch

8-104TC RYDER Needle Holder 7" (17.8 cm), serrated jaws 4000 teeth p. sq. inch

8-105TC RYDER Needle Holder 8" (20.3 cm), serrated jaws 4000 teeth p. sq. inch

8-106TC RYDER Needle Holder 9" (22.9 cm), serrated jaws 4000 teeth p. sq. inch

8-107TC RYDER Needle Holder 10 1/4" (26 cm), serrated jaws 4000 teeth p. sq. inch

8-134TC WANGENSTEEN Needle Holder 10 3/4" (27.3 cm), serrated jaws 2600 teeth p. sq. inch

18-1800TC KALT Needle Holder 5 1/2" (14 cm), serrated jaws 16000 teeth p. sq. inch

18-1816TC MILTEX-CASTROVIEJO Needle Holder 4 1/8" (10.5 cm), round handles, with lock, delicate smooth jaws

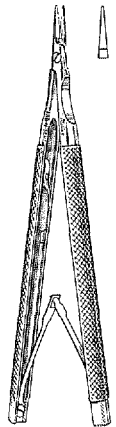

18-1816TC



Carb-N-Sert Needle Holders

CARB-N-SERT NEEDLE HOLDERS
with tungsten carbide inserts insure firm holding of needles and sutures

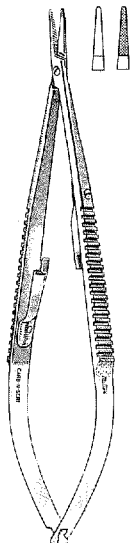

18-1828TC
18-1828A-TC

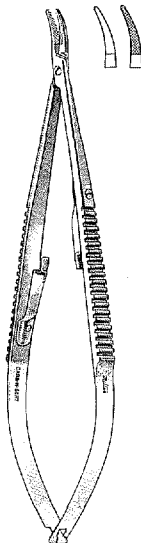

18-1832TC
18-1832A-TC

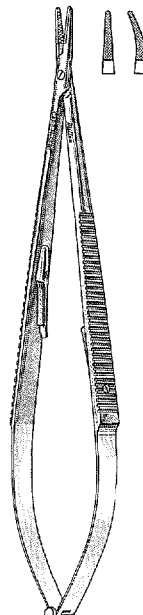

17-1090TC to 17-1092TC

- 18-1828TC** CASTROVIEJO Needle Holder 5 1/2" (14 cm), straight, with lock, smooth jaws
- 18-1828A-TC** CASTROVIEJO Needle Holder 5 1/2" (14 cm), straight, with lock, serrated jaws 16000 teeth p. sq. inch
- 18-1832TC** CASTROVIEJO Needle Holder 5 1/2" (14 cm), curved, with lock, smooth jaws
- 18-1832A-TC** CASTROVIEJO Needle Holder 5 1/2" (14 cm), curved, with lock, serrated jaws 16000 teeth p. sq. inch

- 17-1090TC** JACOBSON Microvascular Needle Holder 7" (17.8 cm), straight, with lock, serrated jaws 16000 teeth p. sq. inch
- 17-1091TC** JACOBSON Microvascular Needle Holder 7" (17.8 cm), curved, with lock, serrated jaws 16000 teeth p. sq. inch
- 17-1092TC** JACOBSON Microvascular Needle Holder 8 1/2" (21.6 cm), straight, with lock, serrated jaws 16000 teeth p. sq. inch

Carb-N-Sert Needle Holders



CARB-N-SERT NEEDLE HOLDERS
with tungsten carbide inserts
insure firm holding of needles and sutures

With QUICK-RELEASE RATCHET
(suitable for Left Handers)

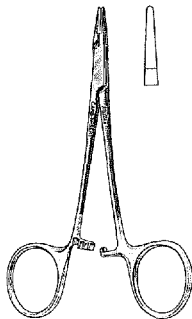

8-706TC

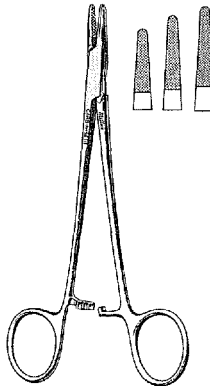

8-744TC to 8-748TC

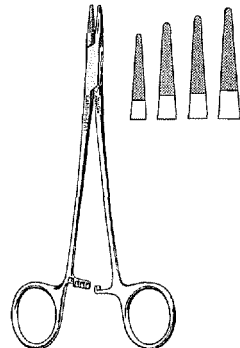

8-750TC to 8-753TC

- 8-706TC** WEBSTER Quick-Release Needle Holder 5" (12.7 cm), smooth jaws
- 8-744TC** MAYO-HEGAR Quick-Release Needle Holder 6" (15.2 cm), serrated jaws 2600 teeth p. sq. inch
- 8-746TC** MAYO-HEGAR Quick-Release Needle Holder 7" (17.8 cm), serrated jaws 2600 teeth p. sq. inch
- 8-748TC** MAYO-HEGAR Quick-Release Needle Holder 8" (20.3 cm), serrated jaws 2600 teeth p. sq. inch
- 8-750TC** CRILE-WOOD Quick-Release Needle Holder 6" (15.2 cm), serrated jaws 4000 teeth p. sq. inch
- 8-751TC** CRILE-WOOD Quick-Release Needle Holder 7" (17.8 cm), serrated jaws 4000 teeth p. sq. inch
- 8-752TC** CRILE-WOOD Quick-Release Needle Holder 8" (20.3 cm), serrated jaws 4000 teeth p. sq. inch
- 8-753TC** CRILE-WOOD Quick-Release Needle Holder 9" (22.9 cm), serrated jaws 4000 teeth p. sq. inch



Surgical Needles

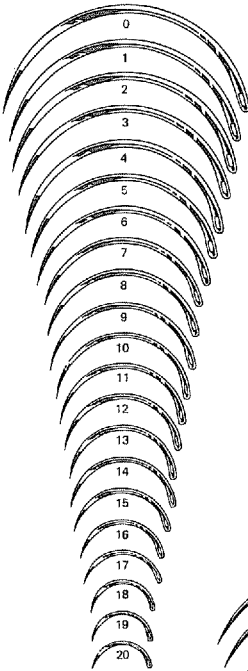

MS-192
REGULAR SURGEON'S
1/2 Circle
Cutting Edge

MS-192S
Same as above
with Spring Eye

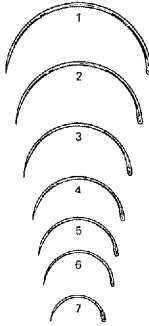

MS-150
ROUND BODIED
1/2 Circle
Taper Point

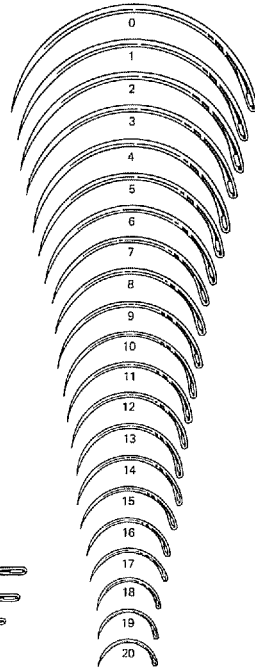

MS-192A
REGULAR SURGEON'S
1/2 Circle
Taper Point

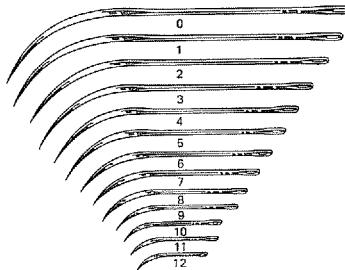

MS-141
REGULAR SURGEON'S
Half Curved
Cutting Edge

All needles shown actual size

Needles are packed in packages of 12.

Surgical Needles

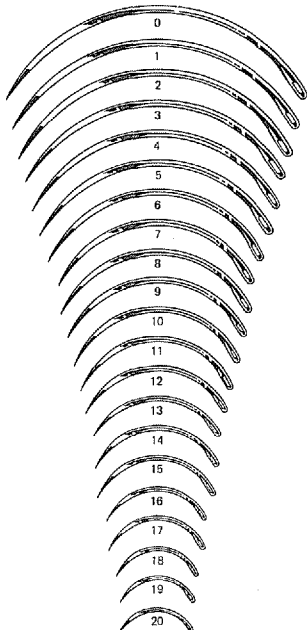

MS-140
REGULAR SURGEON'S
3/8 Circle
Cutting Edge

MS-140S
Same as above
with Spring Eye

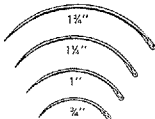

MS-153
MAYO INTESTINAL
3/8 Circle
Taper Point

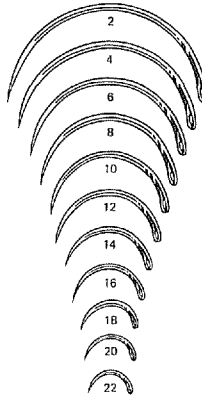

MS-126
FERGUSON
1/2 Circle
Taper Point

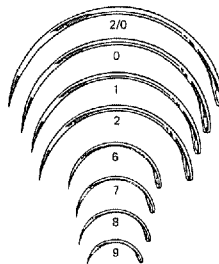

MS-450
FISTULA
1/2 Circle
Cutting Edge

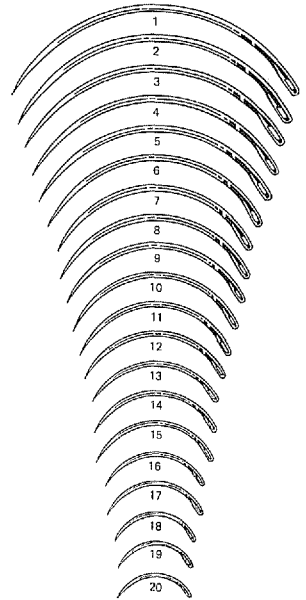

MS-140A
REGULAR SURGEON'S
3/8 Circle
Taper Point

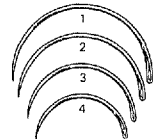

MS-179
MURPHY'S INTESTINAL
1/2 Circle
Taper Point

All needles shown actual size.

Needles are packed in packages of 12.



Surgical Needles

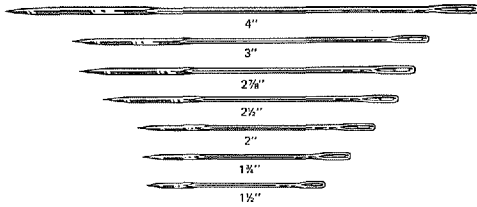

MS-431
KEITH ABDOMINAL
Straight
Triangular Point

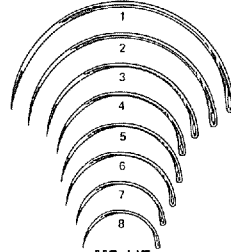

MS-117
MARTIN'S UTERINE
1/2 Circle
Cutting Edge

Eye Needles

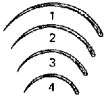

MS-172
EYE NEEDLE
3/8 Circle
Cutting Edge



MS-175
EYE NEEDLE
1/2 Circle
Cutting Edge



MS-177
JAMESON STRABISMUS
Cutting Edge



MS-176
EYE NEEDLE
1/2 Circle
Taper Point

Dental Needles



MS-155
LANE CLEFT PALATE
3/8 Circle
Cutting Edge



MS-156
LANE CLEFT PALATE
1/2 Circle
Cutting Edge



MSRC-14
MSRC-18
DENTAL
REVERSE CUTTING EDGE
1/2 Circle

Needles are packed in packages of 12.

Surgical Needles

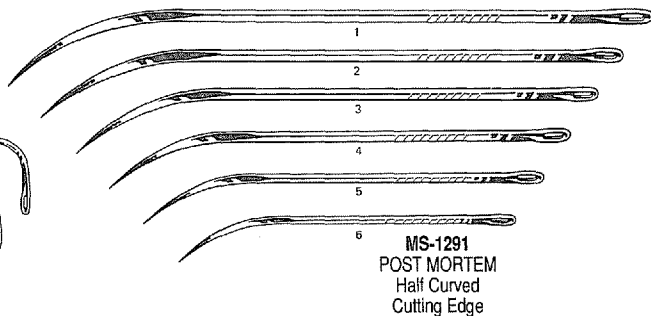
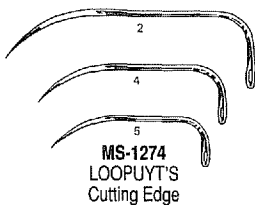
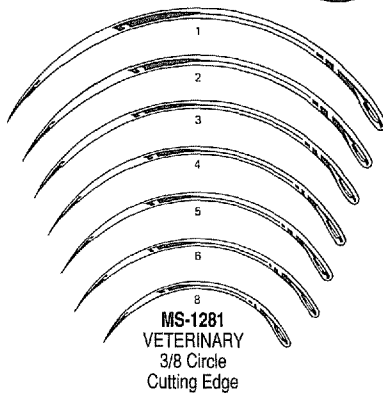
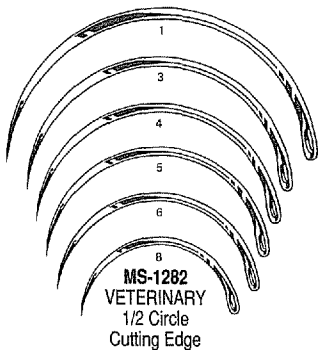

All needles have Regular eyes,
unless otherwise noted.

Needles are packed
in packages of 12.

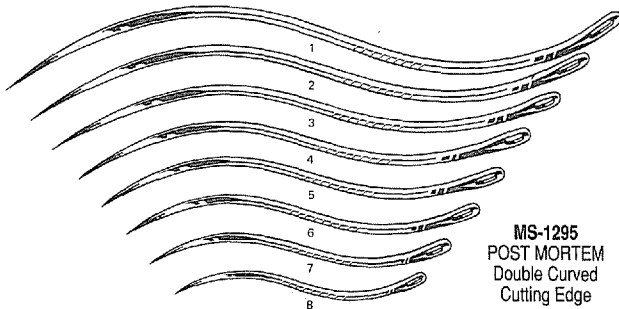



Suture Sundries

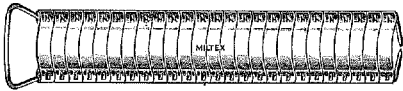

9-1 to 9-10

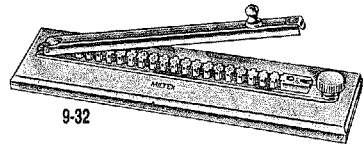

9-32

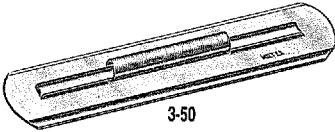

3-50

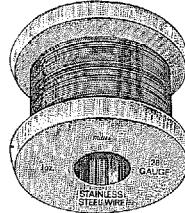

9-40 to 9-44

MICHEL WOUND CLIPS (100 to an envelope, 1000 to a box), stainless

9-1	size 7.5 mm	9-6	size 16 mm
9-2	size 11 mm	9-8	size 18 mm
9-4	size 14 mm	9-10	size 22 mm

9-32 McKENZIE Brain Clip Holding Rack, for 20 clips

3-50 Sterilizing Spiral Rack for Surgical Needles

BABCOCK SUTURE WIRE, Stainless Steel Type AISI 316-L

B&S Gauge	Diameter	1 oz. (28 g) Spools	4 oz. (113 g) Spools
18	.040" (1 mm)	9-40-18	9-44-18
20	.032" (.8 mm)	9-40-20	9-44-20
22	.025" (.6 mm)	9-40-22	9-44-22
24	.020" (.5 mm)	9-40-24	9-44-24
25	.018" (.45 mm)	9-40-25	9-44-25
26	.016" (.4 mm)	9-40-26	9-44-26
28	.012" (.3 mm)	9-40-28	9-44-28
30	.010" (.25 mm)	9-40-30	9-44-30
32	.008" (.2 mm)	9-40-32	9-44-32
34	.006" (.15 mm)	9-40-34	9-44-34
36	.005" (.13 mm)	9-40-36	—



9-50



9-52



9-54



9-60

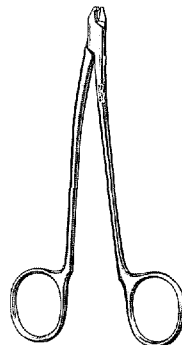

9-62

- 9-50 MICHEL Clip Applying Forceps 4¾" (12.1 cm)
- 9-52 HEGENBARTH Clip Applying Forceps 4¾" (12.1 cm), cross action
- 9-54 WACHENFELD Clip Applying-Removing Forceps 4¾" (12.1 cm), cross action
- 9-60 MICHEL Clip Applying-Removing Forceps 5" (12.7 cm), double ended
- 9-62 MILTEK Skin Staple Removing Forceps 5½" (14 cm)

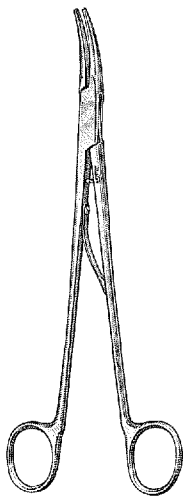

9-74

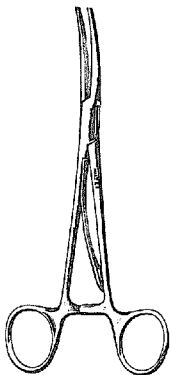

9-80

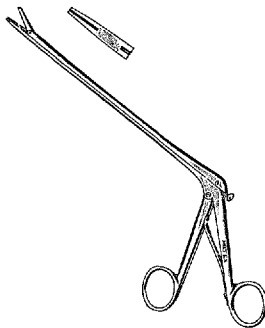

9-90

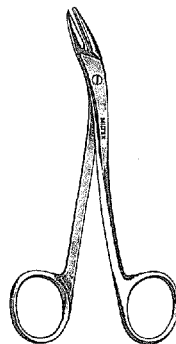

9-94

- 9-74 SMITHWICK Clip Applying Forceps 9" (22.9 cm), curved jaws, straight handles
- 9-80 MCKENZIE Clip Applying Forceps 6" (15.2 cm), curved jaws, straight handles
- 9-90 SCOVILLE Clip Applying Forceps 6" (15.2 cm) shaft
- 9-94 RICHTER HEATH Clip Removing Forceps 5½" (14 cm)



17-303



18-1107

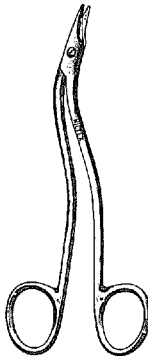

9-96

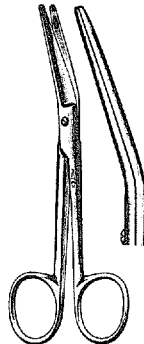

9-98

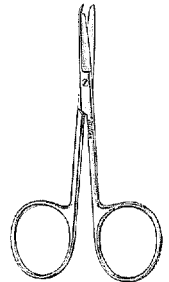

9-100

- 17-303 Suture Forceps (style 3), narrow, fine 4 $\frac{3}{4}$ " (12.1 cm)
- 18-1107 Swiss Cilia and Suture Forceps 3 $\frac{3}{4}$ " (9.5 cm), precision fitted diagonal jaws 3 mm wide
- 9-96 HEATH Suture Scissors 6 $\frac{1}{8}$ " (15.4 cm), serrated blade
- 9-98 NEW'S Suture Scissors 5 $\frac{1}{2}$ " (14 cm), angled on flat
- 9-100 SPENCER Stitch Scissors 3 $\frac{1}{2}$ " (8.9 cm), delicate
- 9-101 SHORTBENT Stitch Scissors 3 $\frac{1}{2}$ " (8.9 cm), curved, delicate
- 9-102 LITTAUER JR. Stitch Scissors 4 $\frac{1}{2}$ " (11.4 cm), light pattern

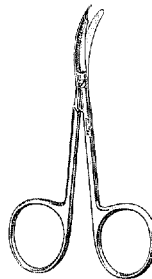

9-101

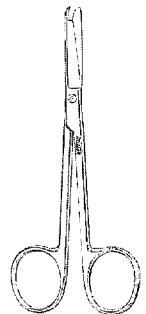

9-102

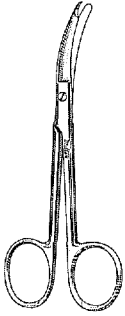

9-103

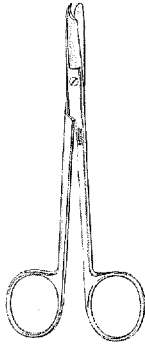

9-104

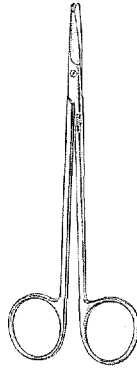

9-106

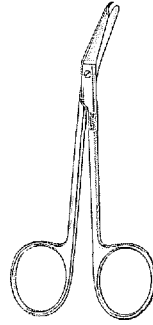

9-108

- 9-103 NORTHBENT Stitch Scissors 4¾" (12.1 cm), curved, light pattern
- 9-104 LITTAUER Stitch Scissors 5½" (14 cm), standard pattern
- 9-106 LONG Oral Surgery Stitch Scissors 6" (15.2 cm)
- 9-108 MILTEX Stitch Scissors 4½" (11.4 cm), angled, delicate
- 9-110 O'BRIEN Stitch Scissors 3¾" (9.5 cm), angled, sharp points

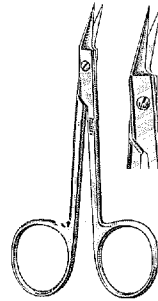

9-110



18-1486

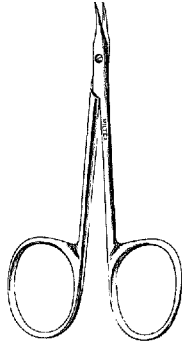

18-1652

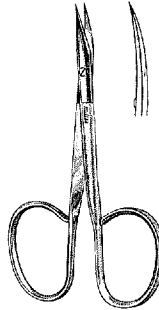

18-1653*

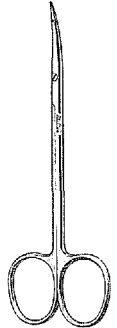

21-536

- 18-1486** WESTCOTT Stitch Scissors 4½" (11.4 cm), curved, sharp points
- 18-1652** Eye Suture (GRADLE) Scissors 3¾" (9.5 cm), slightly curved, sharp points
- 18-1653*** Eye Suture Scissors 4" (10.2 cm), slightly curved, sharp points, ribbon type
- 21-536** LITTLER Suture Carrying Scissors 4¾" (11.8 cm), with suture hole in blades, curved

For a complete selection of Carb-N-Sert Eye Scissors with Tungsten Carbide blades and Super Cut Scissors see pages 58, 62 and 63.

*Ribbon type scissors have extra large finger rings; shanks and rings have satin finish; blades are highly polished.

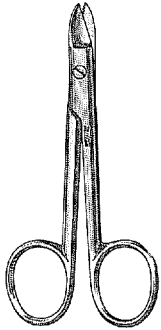

9-120
9D-121

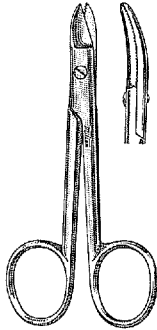

9-122
9D-123

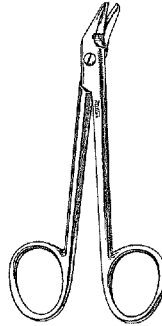

9-124
9-124TC

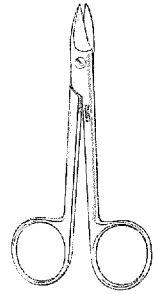

9D-132
9D-133

WIRE CUTTING SCISSORS 4 $\frac{3}{4}$ " (12.1 cm)

- 9-120 Straight, one serrated blade
- 9D-121 Straight
- 9-122 Curved, one serrated blade
- 9D-123 Curved
- 9-124 Angled to side, one serrated blade
- 9-124TC Angled to side, one serrated blade, Carb-N-Sert inserts

WIRE CUTTING SCISSORS 4 $\frac{1}{4}$ " (10.8 cm)

- 9D-132 Straight, one serrated blade
- 9D-133 Straight
- 9D-134 Curved, one serrated blade
- 9D-135 Curved

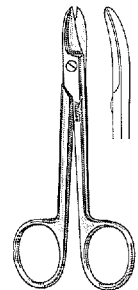

9D-134
9D-135

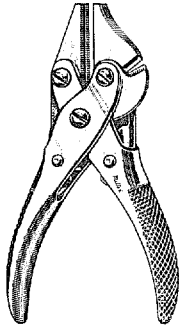

9-128

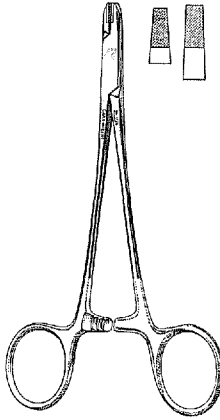

22-500TC
22-502TC

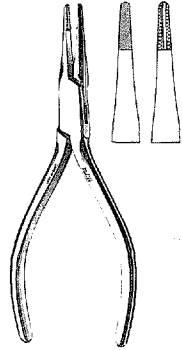

27-176TC

- 9-128 Double Action Parallel Pliers and Wire Cutter
4½" (11.4 cm), nickel plated
- 22-500TC Wire Twister 6" (15.2 cm), CARB-N-SERT jaws
- 22-502TC Wire Twister 8" (20.3 cm), CARB-N-SERT jaws
- 27-176TC MILTEX Pin Puller 5½" (14 cm), CARB-N-SERT cross serrated
top jaw measures 1 cm in length. Grooved cross serrated
opposing jaw (groove measures 1 cm in length).
- 9-140 DESCHAMPS Ligature Carrier 8" (20.3 cm), blunt, left
- 9-142 DESCHAMPS Ligature Carrier 8" (20.3 cm), blunt, right
- 9-146 DESCHAMPS Ligature Carrier 8" (20.3 cm), sharp, left
- 9-148 DESCHAMPS Ligature Carrier 8" (20.3 cm), sharp, right

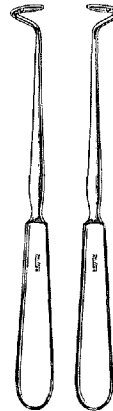

9-140
9-142

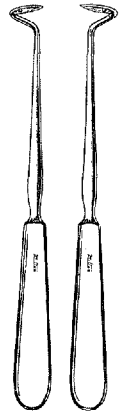

9-146
9-148

For additional Orthopedic Pin & Wire instruments see pages 443,444

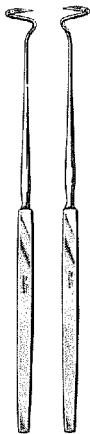

9-154
9-156



12-90
12-92



21-900

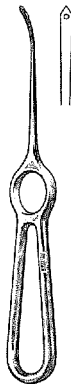

21-901



21-902

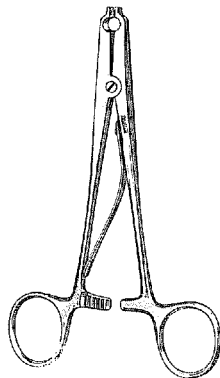

26-590

- 9-154 DUPUYSS-WEISS Ligature Carrier 8½" (21.6 cm), right
- 9-156 DUPUYSS-WEISS Ligature Carrier 8½" (21.6 cm), left
- 12-90 LAHEY Ligature Carrier 7½" (19.1 cm), curved left
- 12-92 LAHEY Ligature Carrier 7½" (19.1 cm), curved right
- 21-900 OBWEGESER Mandibular Awl for wire suturing 5½" (14 cm), slightly curved
- 21-901 OBWEGESER Maxillary Awl for wire suturing 7" (17.8 cm), strong curve
- 21-902 OBWEGESER Zygomatic Arch Awl for wire suturing 9" (22.9 cm), slightly curved
- 26-590 RANEY Scalp Clip Applying Forceps 6¼" (15.9 cm)
- 26-591 RANEY Reusable Scalp Clips, black finish (pkg. of 12)
- 26-660 ADSON Aneurysm Needle 9" (22.9 cm)
- 27-110 Bone Wire Guide 8¾" (22.2 cm), U.S. Pattern



26-591



26-660



27-110

Probes and Directors



10-2 to 10-14



10-22 to 10-34



10-38



10-69 to 10-76



10-79 to 10-84



28-100

PROBES, DOUBLE ENDED, Malleable

Nickel-Silver

10-2-NS	4½" (11.4 cm)
10-4-NS	5" (12.7 cm)
10-6-NS	5½" (14 cm)
10-8-NS	6" (15.2 cm)
10-10-NS	7" (17.8 cm)
10-12-NS	8" (20.3 cm)
10-14-NS	10" (25.4 cm)

Sterling

10-2-ST	
10-4-ST	
10-6-ST	
10-8-ST	
10-10-ST	
10-12-ST	
10-14-ST	

PROBES WITH EYE, Malleable

Stainless

10-22-SS	4½" (11.4 cm)
10-24-SS	5" (12.7 cm)
10-26-SS	5½" (14 cm)
10-28-SS	6" (15.2 cm)
10-30-SS	7" (17.8 cm)
10-32-SS	8" (20.3 cm)
10-34-SS	10" (25.4 cm)

Sterling

10-22-ST	
10-24-ST	
10-26-ST	
10-28-ST	
10-30-ST	
10-32-ST	
10-34-ST	

10-38

Probe with Myrtle Leaf 5" (12.7 cm)

GROOVED DIRECTORS

With
Tongue Tie

10-69	4½" (11.4 cm)
10-70	5" (12.7 cm)
10-72	5½" (14 cm)
10-74	6" (15.2 cm)
10-76	8" (20.3 cm)

With Probe Tip and
Tongue Tie

10-79	
10-80	
10-82	
10-84	
—	

28-100

LARRY Probe and Grooved Director 7" (17.8 cm)



Probes

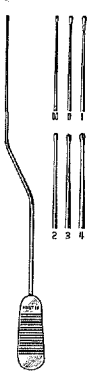

18-710 to 18-720

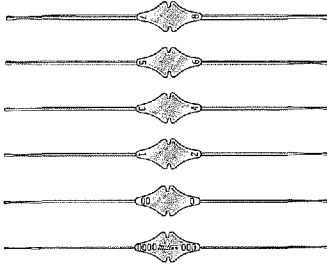

18-722 to 18-732

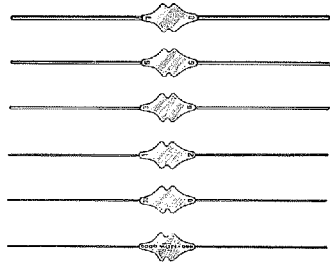

18-740 to 18-750

FRENCH PATTERN LACRIMAL PROBES 5" (12.7 cm)

Bayonet shape

18-710	size 00	18-716	size 2
18-712	size 0	18-718	size 3
18-714	size 1	18-720	size 4

WILLIAMS LACRIMAL PROBES 5" (12.7 cm), sterling

18-722	size 0000-000	18-728	size 3-4
18-724	size 00-0	18-730	size 5-6
18-726	size 1-2	18-732	size 7-8

BOWMAN LACRIMAL PROBES 5" (12.7 cm), sterling

18-740	size 0000-000	18-746	size 3-4
18-742	size 00-0	18-748	size 5-6
18-744	size 1-2	18-750	size 7-8

19-210 BUCK (SPENCER) Ear Probe
5½" (14 cm), sterling shaft

20-100 THEOBALD (FISH) Sinus Probe
6" (15.2 cm), sterling

20-102 SKILLERN Sinus Probe 6½" (16.5 cm),
graduated, sterling

28-104 BARR Fistula Probe, with 8" (20.3 cm)
sterling shaft, eye at tip, 1½" (29.2 cm) overall



19-210



20-100



20-102

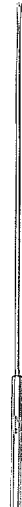

28-104

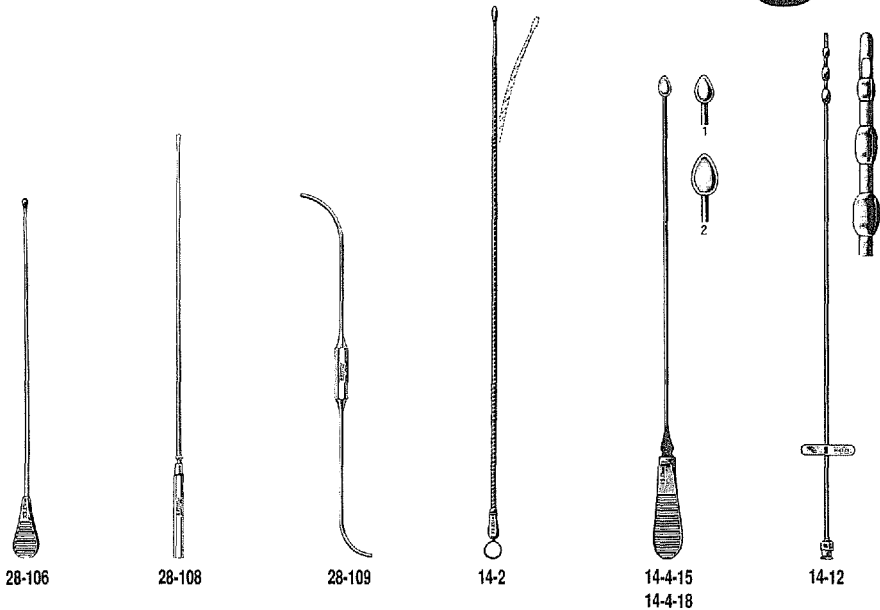

- 28-106** BUIE Fistula Probe, with 5½" (14 cm) sterling shaft, 6¾" (17.1 cm) overall
- 28-108** PRATT Rectal Probe, with 7¾" (19.7 cm) sterling shaft, 11" (27.9 cm) overall
- 28-109** BARR Double Ended Probe 7" (17.8 cm), rigid
- 14-2** OCHSNER (FENGER) Gall Duct Probe, cannulated flexible spiral 14" (35.6 cm) with stylet
- 14-4-15** MAYO Common Duct Probe 10" (25.4 cm), malleable shaft, 15 French (5 mm)
- 14-4-18** MAYO Common Duct Probe 10" (25.4 cm), malleable shaft, 18 French (5.9 mm)
- 14-12** MIXTER Irrigating Dilaprobe 12" (30.5 cm), malleable, with Luer Lock, silver plated

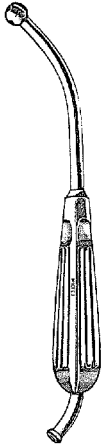

2-100

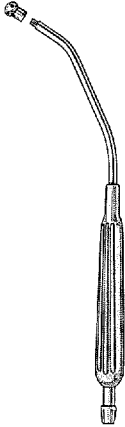

2-109



2-110
2-110SS

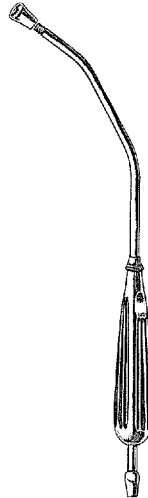

2-104
2-104SS



2-106
2-106SS

- 2-100 PYNCHON Suction Tube 11" (27.9 cm), tip with large openings, with removable tubing connection, chrome
- 2-109 YANKAUER Pediatric Suction Tube 8½" (21.6 cm), with removable tip, delicate pattern
- 2-110 ANDREWS-PYNCHON Suction Tube 10" (25.4 cm), delicate pattern, chrome
- 2-110SS ANDREWS-PYNCHON Suction Tube 10" (25.4 cm), delicate pattern
- 2-104 YANKAUER Suction Tube 11¾" (29.8 cm), with removable tip and tubing connection, chrome
- 2-104SS YANKAUER Suction Tube 11¾" (29.8 cm), with removable tip and tubing connection
- 2-106 Tip for Yankauer Suction Tube, chrome
- 2-106SS Tip for Yankauer Suction Tube
- 10-220 ANTHONY Suction Tube 10" (25.4 cm), lumen 2 mm, chrome

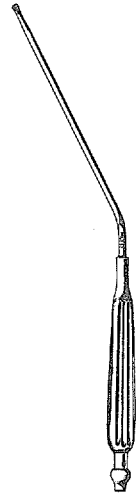

10-220

Suction Tubes

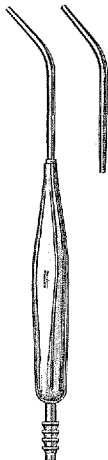

20-466

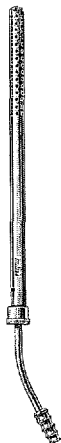

10-310



10-312



19-562 to 19-565

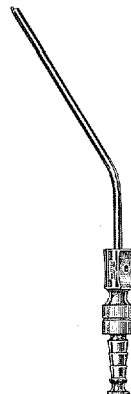

19-570 to 19-577

20-466 COUPLAND Suction Tube 10" (25.4 cm), with 2 interchangeable tips 1.5 and 2 mm, chrome

10-310 POOLE Suction Tube 23 Fr. (7.6 mm), curved

10-312 POOLE Suction Tube 30 Fr. (9.9 mm), straight

HOUSE SUCTION-IRRIGATION TUBES, 9 cm working length

19-562 1.8 mm Suction Tube and 1.8 mm Irrigating Tube

19-563 2.5 mm Suction Tube and 2 mm Irrigating Tube

19-564 3 mm Suction Tube and 2 mm Irrigating Tube

19-565 4.5 mm Suction Tube and 2 mm Irrigating Tube

FRAZIER FERGUSON SUCTION TUBES, with finger cut-off, angled

19-570 6 French (2 mm)

19-575 10 French (3.3 mm)

19-572 7 French (2.3 mm)

19-576 11 French (3.6 mm)

19-573 8 French (2.6 mm)

19-577 12 French (4 mm)

19-574 9 French (3 mm)

20-460 FRAZIER FERGUSON Suction Tube 9 French (3 mm), straight, with finger cut-off



20-460



Suction Tubes



19-580 to 19-584

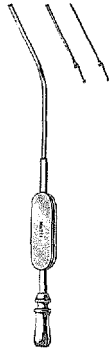

19-1820



19-589



26-780
26-782

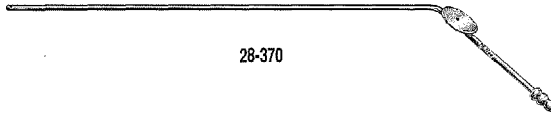

28-370

- 19-580 BARON Suction Tube 3 French (1 mm), with finger cut-off, 7.5 cm tube
- 19-582 BARON Suction Tube 5 French (1.7 mm), with finger cut-off, 7.5 cm tube
- 19-584 BARON Suction Tube 7 French (2.3 mm), with finger cut-off, 7.5 cm tube
- 19-1820 Ear Suction Tube with 2 interchangeable tips 20 ga. and 22 ga.
- 19-589 ANTHONY Suction Tube 6½" (16.5 cm), with 3 mm lumen
- 26-780 ADSON Suction Tube 6" (15.2 cm), with finger valve and obturator, 11 Fr. (3.6 mm)
- 26-782 ADSON Suction Tube 8" (20.3 cm), with finger valve and obturator, 15 Fr. (5 mm)
- 28-370 BUIE Suction Tube 16" (40.6 cm), with finger valve, 15 Fr. (5 mm)

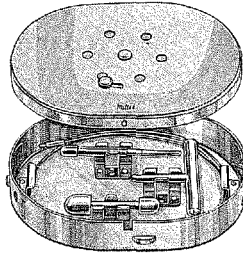

10-290
10-291

- 10-290** NABATOFF Vein Stripper Set, including 2 probe tips, 9 mm, 12 mm and 15 mm olives, and handle with screws on either end of 34" (86.4 cm) cable. Complete in sterilizer case.
- 10-291** NABATOFF Vein Stripper Set, without sterilizer case.

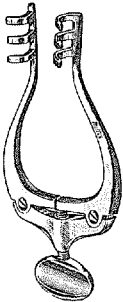

11-2

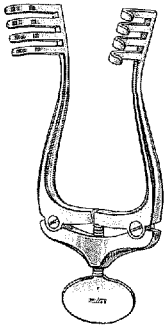

11-4

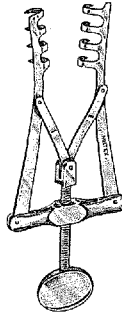

11-6

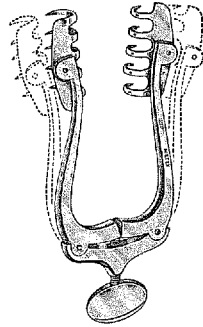

11-8

- 11-2 JANSEN Retractor 4¼" (10.8 cm), spread 3" (7.6 cm), 3 x 3 blunt prongs
10 mm deep, standard model
- 11-4 JANSEN Retractor 4½" (11.4 cm), spread 3" (7.6 cm), 4 x 4 blunt prongs
20 mm deep
- 11-6 ALLPORT Retractor 4" (10.2 cm), spread 2½" (6.4 cm), 4 x 4 sharp prongs
- 11-8 JANSEN-WAGNER Retractor 5" (12.7 cm), 5 x 5 sharp prongs, self-adjusting
- 11-10 DAVIS Retractor 4½" (11.4 cm), 3 x 3 blunt prongs



11-10

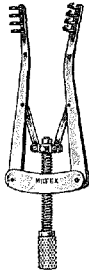

11-12
11-13

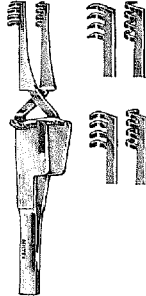

11-14
11-16

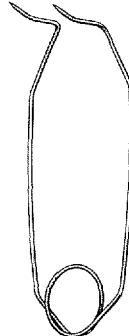

11-17
11-18

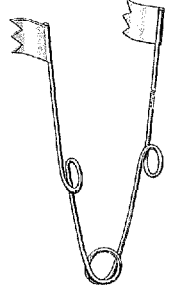

11-19

- 11-12 ALM Retractor 2 $\frac{3}{4}$ " (7 cm), spread 2 $\frac{1}{4}$ " (5.7 cm), prongs $\frac{1}{8}$ " (.32 cm) deep
- 11-13 ALM Retractor 3 $\frac{5}{8}$ " (9.8 cm), spread 3" (7.6 cm), prongs $\frac{1}{2}$ " (1.3 cm) deep
- 11-14 MILTEX Cross Action Retractor 4" (10.2 cm), sharp prongs
- 11-16 MILTEX Cross Action Retractor 4" (10.2 cm), blunt prongs
- 11-17 FARR Wire Retractor 5 $\frac{1}{2}$ " (14 cm), prongs $\frac{3}{4}$ " (1.9 cm)
- 11-18 FARR Wire Retractor 5 $\frac{1}{2}$ " (14 cm), prongs 1 $\frac{1}{8}$ " (2.8 cm)
- 11-19 Spring Wire Retractor 3 $\frac{1}{4}$ " (8.3 cm), with blades 10 mm wide x 13 mm deep

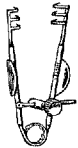

18-80

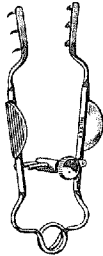

18-84

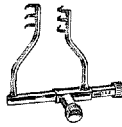

18-88

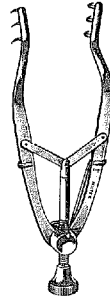

18-96

- 18-80** AGRICOLA Retractor 1½" (3.8 cm), 3 x 3 pointed prongs 4 mm deep, non-magnetic
- 18-84** MELLER Retractor 2⅞" (7.3 cm), 3 x 3 prongs 3 mm deep, non-magnetic
- 18-88** GOLDSTEIN Retractor 1⅞" (2.8 cm), 3 x 3 pointed prongs 5 mm deep, non-magnetic
- 18-96** STEVENSON Retractor 3¼" (8.3 cm), 3 x 3 prongs 3 mm deep, non-magnetic

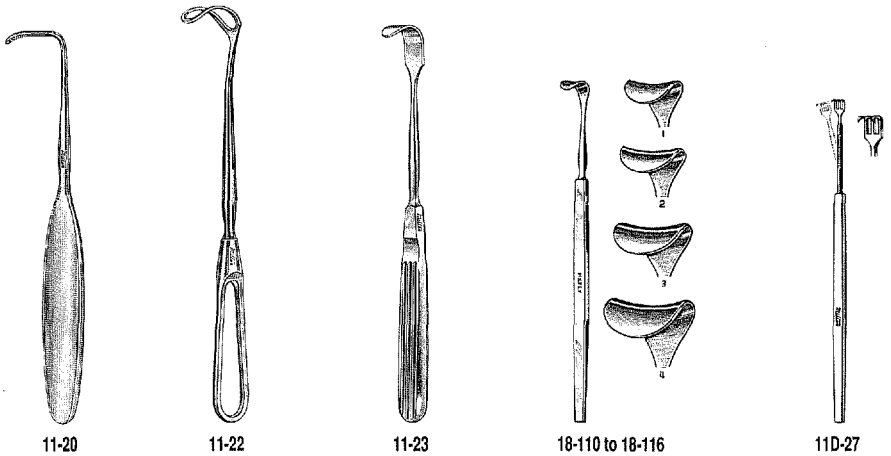

- 11-20 LAHEY Retractor 7/4" (19.7 cm)
- 11-22 GREEN Retractor 8 1/2" (21.6 cm)
- 11-23 LITTLE Retractor 7/4" (19.7 cm)
- 18-110 DESMARRES Retractor 5 1/2" (14 cm), size 1, 11 mm
- 18-112 DESMARRES Retractor 5 1/2" (14 cm), size 2, 13 mm
- 18-114 DESMARRES Retractor 5 1/2" (14 cm), size 3, 15 mm
- 18-116 DESMARRES Retractor 5 1/2" (14 cm), size 4, 17 mm
- 11D-27 Flexible Neck Rake Retractor 5" (12.7 cm), 3 sharp prongs
- 11-30 Flexible Neck Rake Retractor 6" (15.2 cm), 1 sharp prong
- 11-32 Flexible Neck Rake Retractor 6" (15.2 cm), 2 sharp prongs
- 11-34 Flexible Neck Rake Retractor 6" (15.2 cm), 3 sharp prongs
- 11-36 Flexible Neck Rake Retractor 6" (15.2 cm), 1 blunt prong
- 11-38 Flexible Neck Rake Retractor 6" (15.2 cm), 2 blunt prongs
- 11-40 Flexible Neck Rake Retractor 6" (15.2 cm), 3 blunt prongs

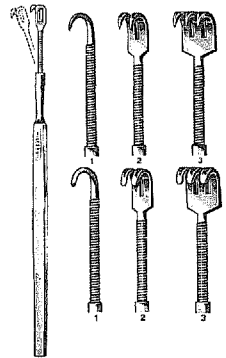

11-30 to 11-40

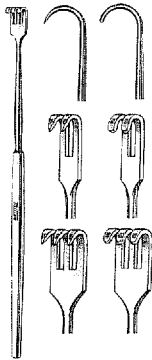

11-50 to 11-60



18-100
18-102



18-439

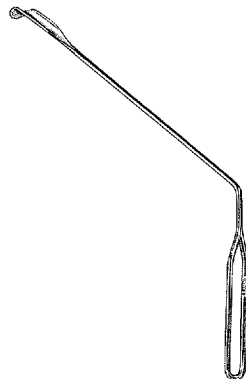

20-835

- 11-50 Rigid Neck Rake Retractor 6" (15.2 cm), 1 sharp prong
- 11-52 Rigid Neck Rake Retractor 6" (15.2 cm), 2 sharp prongs
- 11-54 Rigid Neck Rake Retractor 6" (15.2 cm), 3 sharp prongs
- 11-56 Rigid Neck Rake Retractor 6" (15.2 cm), 1 blunt prong
- 11-58 Rigid Neck Rake Retractor 6" (15.2 cm), 2 blunt prongs
- 11-60 Rigid Neck Rake Retractor 6" (15.2 cm), 3 blunt prongs
- 18-100 KNAPP (ROLLET) Retractor 5¼" (13.3 cm), with 4 sharp prongs
- 18-102 KNAPP Retractor 5¼" (13.3 cm), with 4 blunt prongs
- 18-439 McGANNON Retractor 5" (12.7 cm), fenestrated blade 2.5 mm wide
- 20-835 LOTHROP Retractor 8" (20.3 cm) shaft, grooved blade 40 x 18 mm with 5 mm lip
- 20-836 LOVE Retractor, 18 mm wide blade
- 20-838 LOVE Retractor, 20 mm wide blade
- 20-840 LOVE Retractor, 22 mm wide blade

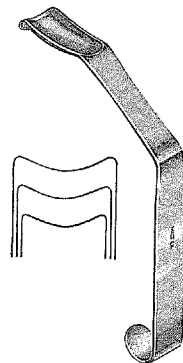

20-836 to 20-840

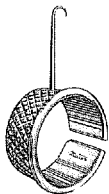

21-107

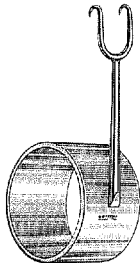

21-108



21-148



21-150



21-163

- 21-107 MILLARD Thimble Retractor, $\frac{5}{8}$ " (1.6 cm) working length, sharp single hook
- 21-108 COTTLE Thumb Retractor, $1\frac{1}{2}$ " (3.8 cm) working length, sharp double hook 8 mm wide
- 21-148 FOMON Retractor $6\frac{1}{2}$ " (16.5 cm), two ball end prongs 11 mm wide
- 21-150 COTTLE Retractor $5\frac{1}{2}$ " (14 cm), four blunt prongs, 2 center prongs recessed
- 21-163 CONVERSE Alar Retractor 4" (10.2 cm), double end, with blunt double hooks 10 mm and 14 mm wide
- 21-165 COTTLE Knife Guide and Retractor 8" (20.3 cm), double end, ball tip prongs 10 mm wide, and 5 mm wide slotted hook



21-165



21-176

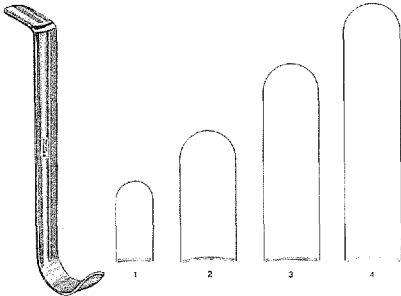

21-182 to 21-185

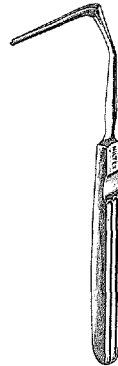

21-188



21-190

- 21-176** NEIVERT Knife Guide and Retractor 6½" (16.5 cm), double end, open blade 14 mm wide
- 21-182** CONVERSE Blade Retractor ¾" (9.5 cm), size 1
- 21-183** CONVERSE Blade Retractor ¾" (9.5 cm), size 2
- 21-184** CONVERSE Blade Retractor ¾" (9.5 cm), size 3
- 21-185** CONVERSE Blade Retractor ¾" (9.5 cm), size 4
- 21-188** AUFRICHT Retractor-Speculum 6½" (16.5 cm), solid blade 45 mm long
- 21-190** AUFRICHT Retractor 7" (17.8 cm), fenestrated blade 45 mm long

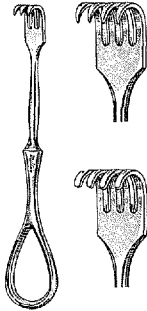

11-42 to 11-49



11-73

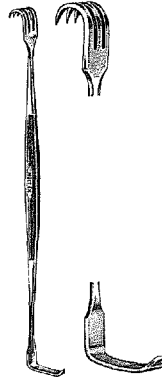

11-74
11-76



11-78



11-79

VOLKMAN FINGER RETRACTORS 4½" (11.4 cm)

Sharp		Blunt
11-42	2 prongs	11-46
11-43	3 prongs	11-47
11-44	4 prongs	11-48
11-45	6 prongs	11-49

- 11-73 RAGNELL Retractor 6" (15.2 cm), double end 3 x 8 mm and 5 x 15 mm blades, delicate
- 11-74 SENN Retractor 6¾" (16.2 cm), sharp, double end
- 11-76 SENN Retractor 6¾" (16.2 cm), blunt, double end
- 11-78 CRILE Retractor 4½" (11.4 cm), double end 3 x 11 mm and 6 x 20 mm blades
- 11-79 LUER S-Shape Retractor 5½" (14 cm), double end 10 x 5 mm and 14 x 9 mm

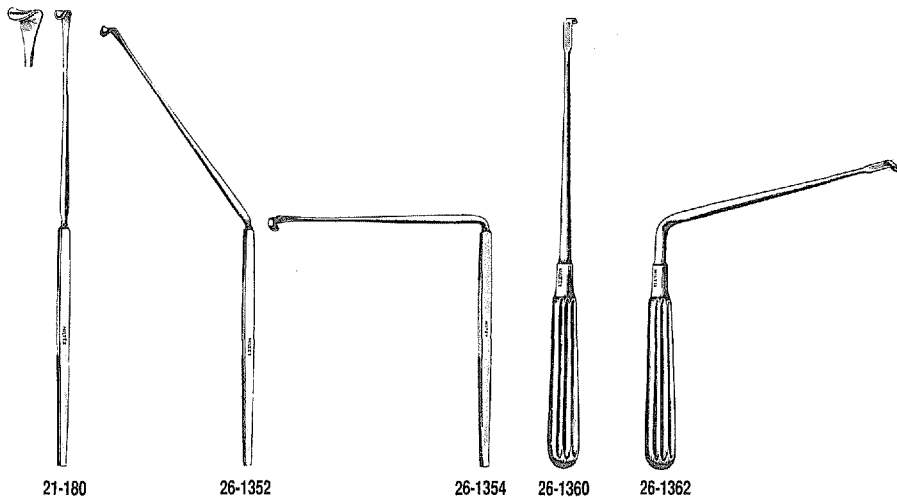

- 21-180** LOVE Nerve Retractor 8½" (21.6 cm), straight, 7 mm blade
- 26-1352** LOVE Nerve Root Retractor 8½" (21.6 cm), angled 45°, 7 mm blade
- 26-1354** LOVE Nerve Root Retractor 8½" (21.6 cm), angled 90°, 7 mm blade
- 26-1360** SCOVILLE Nerve Root Retractor 9" (22.9 cm), straight, 8 mm wide blade
- 26-1362** SCOVILLE Nerve Root Retractor 9" (22.9 cm), angular, 8 mm wide blade
- 11-80** MATHIEU Retractor 6½" (16.5 cm), sharp, double end
- 11-81** MATHIEU Retractor 6½" (16.5 cm), blunt, double end



11-80
11-81



11-82

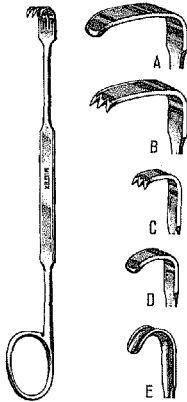

11-88 to 11-96

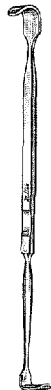

23-1047



23-1049

- 11-82 MEYERDING Skin Hook and Retractor 6 $\frac{1}{4}$ " (15.9 cm), double end
- 11-88 MEYERDING Finger Retractor 7" (17.8 cm), style A. Blade $\frac{1}{4}$ " (.64 cm) x $\frac{1}{16}$ " (1.7 cm)
- 11-90 MEYERDING Finger Retractor 7" (17.8 cm), style B. Blade $\frac{3}{16}$ " (.48 cm) x $\frac{5}{16}$ " (1.6 cm)
- 11-92 MEYERDING Finger Retractor 7" (17.8 cm), style C. Blade $\frac{1}{8}$ " (.32 cm) x $\frac{1}{4}$ " (.64 cm)
- 11-94 MEYERDING Finger Retractor 7" (17.8 cm), style D. Blade $\frac{3}{32}$ " (.24 cm) x $\frac{9}{16}$ " (1 cm)
- 11-96 MEYERDING Finger Retractor 7" (17.8 cm), style E. Blade $\frac{1}{4}$ " (.64 cm) x $\frac{7}{8}$ " (2.2 cm)
- 23-1047 LUKENS Retractor 6 $\frac{3}{4}$ " (17.1 cm), 10 mm wide curved and 7 mm wide angular blades
- 23-1049 JACKSON Retractor 7" (17.8 cm), double end, 2 blunt prongs $\frac{5}{16}$ " (2.4 cm) wide, and solid blade $\frac{3}{8}$ " (1 cm) wide

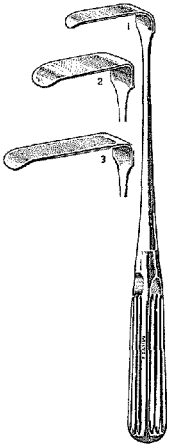

25-272
25-274



11-100



11-102



11-110
11-112



11-114
11-116

- 25-272 SAUERBRUCH Retractor 9" (22.9 cm), blade $\frac{3}{8}$ " (2.2 cm) x $2\frac{1}{4}$ " (5.7 cm)
 25-274 SAUERBRUCH Retractor 9" (22.9 cm), blade $\frac{3}{4}$ " (1.9 cm) x $2\frac{7}{8}$ " (7.3 cm)
- 11-100 CUSHING Decompression Retractor $8\frac{1}{2}$ " (21.6 cm)
 11-102 CUSHING Vein Retractor 9" (22.9 cm), blade 11 x 13 mm
- 11-110 FARABEUF Retractors 6" (15.2 cm), double end, set of two
 11-112 Baby FARABEUF Retractors $4\frac{3}{4}$ " (12.1 cm), double end, set of two
- 11-114 PARKER Retractors 5" (12.7 cm), double end, set of two
 11-116 PARKER Retractors $7\frac{1}{4}$ " (18.4 cm), double end, set of two

Retractors

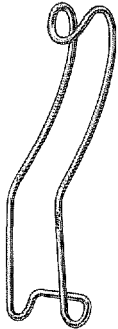

22-200

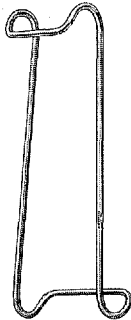

22D-202

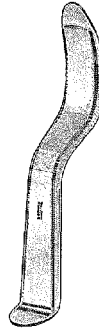

22D-209

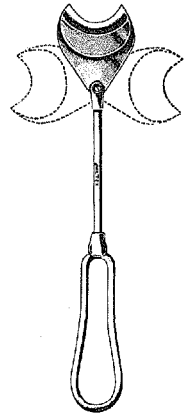

22-210

- 22-200 MILTEX Lip Retractor 6" (15.2 cm), double end 25 mm and 36 mm wide
- 22D-202 COLUMBIA Lip Retractor 5½" (14 cm), double end 37 mm and 50 mm wide
- 22D-209 UNIVERSITY OF MINNESOTA Cheek Retractor 5½" (14 cm), double end 14 mm and 20 mm wide
- 22-210 Cheek Retractor 7¾" (19.7 cm), with swivel blade 35 mm wide
- 22-854 HURD Tonsil Dissector and Pillar Retractor 9" (22.9 cm), standard pattern, 9 x 25 mm blade



22-854



Retractors



22-856



22-890



11-118



11-120



11-122

22-856 MORRISON-HURD Tonsil Dissector and Pillar Retractor 9" (22.9 cm), flat handle, 8 x 25 mm serrated blade

22-890 COLVER Tonsil Examining Retractor 8" (20.3 cm), blunt tip

11-118 MAYO-COLLINS Retractor 6" (15.2 cm), double end, set of two

11-120 GOELET Retractor 7½" (19.1 cm), double end

11-122 U.S. ARMY Retractor 8½" (21.6 cm), double end, set of two

11-130 Ribbon Retractor ¾" (1.9 cm) x 13" (33 cm), malleable

11-132 Ribbon Retractor 1" (2.5 cm) x 13" (33 cm), malleable

11-134 Ribbon Retractor 1¼" (3.2 cm) x 13" (33 cm), malleable

11-136 Ribbon Retractor 1½" (3.8 cm) x 13" (33 cm), malleable

11-140 Ribbon Retractor 2" (5.1 cm) x 13" (33 cm), malleable

11-144 Pediatric Ribbon Retractor ¾" (1.6 cm) x 8" (20.3 cm), malleable

11-146 Pediatric Ribbon Retractor 1" (2.5 cm) x 8" (20.3 cm), malleable

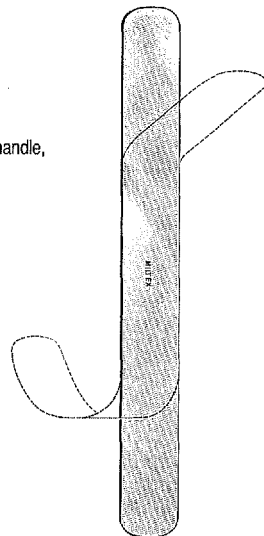

11-130 to 11-146

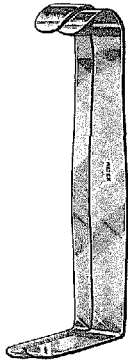

11-150

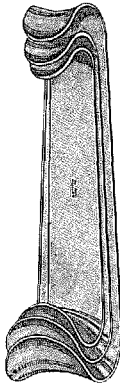

11-152 to 11-155

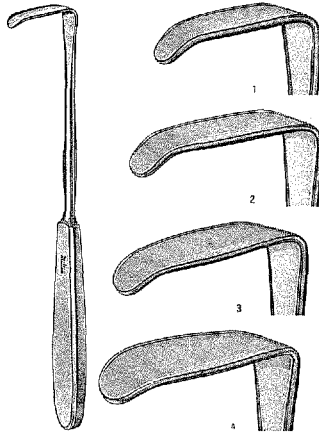

11-160 to 11-166

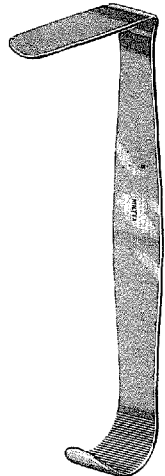

11-180 to 11-184

- 11-150** PARKER-MOTT Retractors 6" (15.2 cm), double end, set of two
- 11-152** ROUX Retractors 6 $\frac{1}{8}$ " (16.8 cm), double end, set of three
- 11-153** ROUX Retractor 5 $\frac{1}{4}$ " (13.3 cm), small 3 $\frac{1}{8}$ " (1.9 cm) x 1" (2.5 cm)
- 11-154** ROUX Retractor 5 $\frac{1}{4}$ " (14.6 cm), medium 7 $\frac{1}{8}$ " (2.2 cm) x 1 $\frac{3}{8}$ " (3.5 cm)
- 11-155** ROUX Retractor 6 $\frac{1}{8}$ " (16.8 cm), large 1" (2.5 cm) x 1 $\frac{5}{8}$ " (4.1 cm)
- 11-160** LANGENBECK Retractor 8" (20.3 cm), blade 3 $\frac{1}{8}$ " (1 cm) x 1 $\frac{1}{4}$ " (3.2 cm)
- 11-162** LANGENBECK Retractor 8" (20.3 cm), blade 3 $\frac{1}{8}$ " (1 cm) x 1 $\frac{1}{2}$ " (3.8 cm)
- 11-164** LANGENBECK Retractor 8" (20.3 cm), blade 1 $\frac{1}{2}$ " (1.3 cm) x 1 $\frac{1}{2}$ " (3.8 cm)
- 11-166** LANGENBECK Retractor 8" (20.3 cm), blade 3 $\frac{1}{8}$ " (1.6 cm) x 1 $\frac{1}{2}$ " (3.8 cm)
- 11-180** HEANEY Retractor 10 $\frac{1}{2}$ " (26.7 cm), blade 1" (2.5 cm) x 1 $\frac{3}{4}$ " (4.4 cm)
- 11-182** HEANEY Retractor 10 $\frac{1}{2}$ " (26.7 cm), blade 1 $\frac{1}{8}$ " (2.8 cm) x 2 $\frac{1}{8}$ " (7.3 cm)
- 11-184** HEANEY Retractor 10 $\frac{1}{2}$ " (26.7 cm), blade 1 $\frac{1}{8}$ " (2.8 cm) x 3 $\frac{1}{4}$ " (8.3 cm)



Retractors

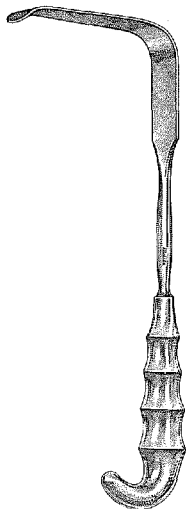

11-185

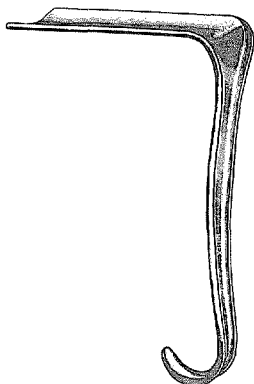

30-300 to 30-310

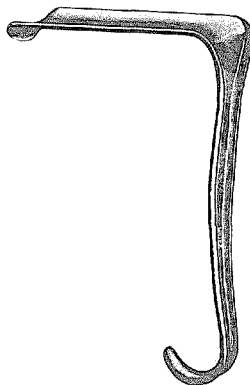

30-320 to 30-330

- 11-185 HEANEY-SIMON Retractor 11½" (29.2 cm), blade 1" (2.5 cm) x 4½" (11.4 cm)
- 30-300 JACKSON Retractor 7" (17.8 cm), Blade 1½" (3.8 cm) x 3" (7.6 cm)
- 30-305 JACKSON Retractor 7" (17.8 cm), Blade 1½" (3.8 cm) x 3½" (8.9 cm)
- 30-310 JACKSON Retractor 7" (17.8 cm), Blade 1½" (3.8 cm) x 4" (10.2 cm)
- 30-320 EASTMAN Retractor 7" (17.8 cm), Blade 1½" (3.8 cm) x 3" (7.6 cm)
- 30-325 EASTMAN Retractor 7" (17.8 cm), Blade 1½" (3.8 cm) x 3½" (8.9 cm)
- 30-330 EASTMAN Retractor 7" (17.8 cm), Blade 1½" (3.8 cm) x 4" (10.2 cm)
- 30-340 DE LEE Universal Retractor 9½" (24.1 cm), Blade 2¾" (7 cm) x 2" (5.1 cm)

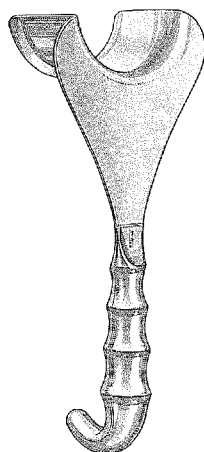

30-340

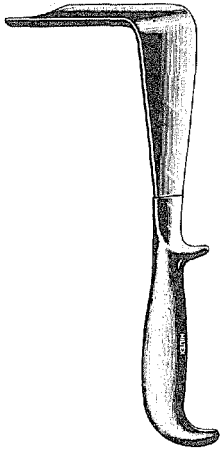

30-395 to 30-415

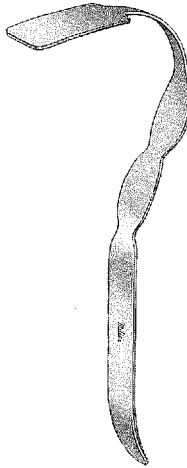

11-192

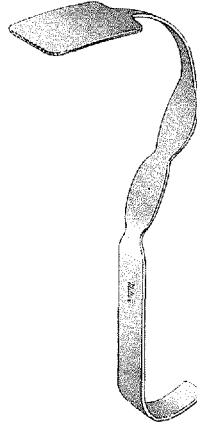

11-194

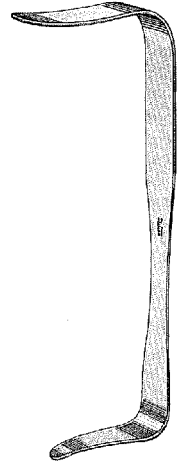

11-200

- 30-395 DOYEN Retractor 9" (22.9 cm), Blade 1¼" (4.4 cm) x 2½" (6.4 cm)
- 30-406 DOYEN Retractor 9" (22.9 cm), Blade 2½" (5.4 cm) x 3" (7.6 cm)
- 30-415 DOYEN Retractor 9" (22.9 cm), Blade 2¼" (5.7 cm) x 3½" (8.9 cm)

- 11-192 JUNG Mini-Chole Retractor 10½" (26.7 cm), 3 cm width blade
- 11-194 JUNG Mini-Chole Retractor 9" (22.9 cm), 4 cm width blade
- 11-196 JUNG Mini-Chole Retractors, set of 2 each of 3 cm width blade and 1 each of 4 cm width blade

- 11-200 DEEVER Retractor 1" (2.5 cm) x 9" (22.9 cm)
- 11-202 DEEVER Retractor 1" (2.5 cm) x 12" (30.5 cm)
- 11-204 DEEVER Retractor 1" (2.5 cm) x 13" (33 cm)

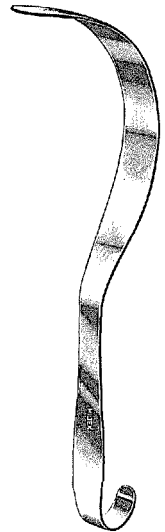

11-202
11-204

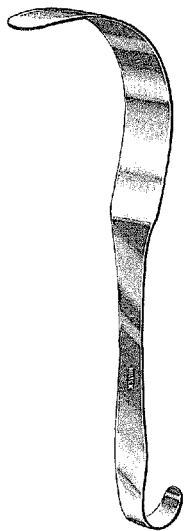

11-206

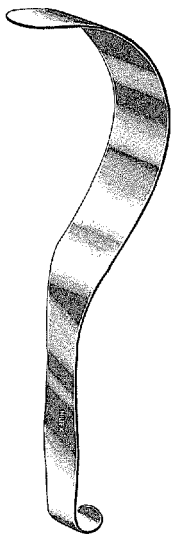

11-208
11-210

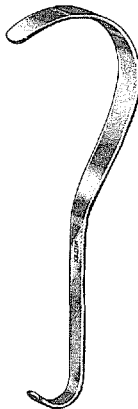

11-218 to 11-220

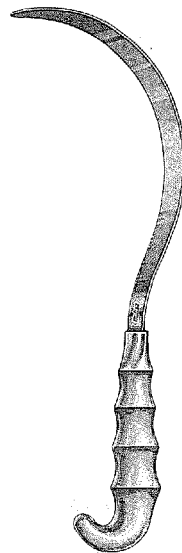

11-221 to 11-223

- | | |
|--------|---|
| 11-206 | DEAVER Retractor 1½" (3.8 cm) x 12" (30.5 cm) |
| 11-208 | DEAVER Retractor 2" (5.1 cm) x 12" (30.5 cm) |
| 11-210 | DEAVER Retractor 3" (7.6 cm) x 12" (30.5 cm) |
| 11-218 | Pediatric DEAVER Retractor 5⁄8" (1.6 cm) x 8½" (21.6 cm) |
| 11-219 | Pediatric DEAVER Retractor ¾" (1.9 cm) x 7" (17.8 cm) |
| 11-220 | Pediatric DEAVER Retractor 7⁄8" (2.2 cm) x 8" (20.3 cm) |
| 11-221 | DEAVER Retractor with Hollow Grip Handle 1" (2.5 cm) x 12" (30.5 cm) |
| 11-222 | DEAVER Retractor with Hollow Grip Handle 1" (2.5 cm) x 13" (33 cm) |
| 11-223 | DEAVER Retractor with Hollow Grip Handle 1½" (3.8 cm) x 12" (30.5 cm) |

Retractors

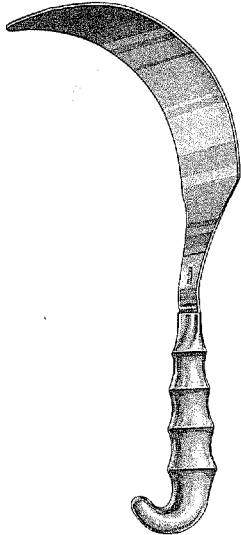

11-224 to 11-225

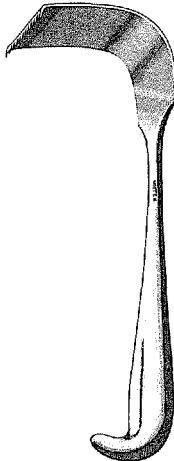

11-240 to 11-244



11-246 to 11-249

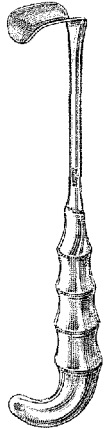

11-250 to 11-256

- 11-224 DEAVER Retractor with Hollow Grip Handle, 2" (5.1 cm) x 12" (30.5 cm)
- 11-224A DEAVER Retractor with Hollow Grip Handle, 3" (7.6 cm) x 12" (30.5 cm)
- 11-225 DEAVER Retractor with Hollow Grip Handle, 4" (10.2 cm) x 12" (30.5 cm)
- 11-240 MEYERDING Retractor 9½" (24.1 cm), large blade, 3½" (8.9 cm) x 2" (5.1 cm)
- 11-242 MEYERDING Retractor 9½" (24.1 cm), medium blade, 3" (7.6 cm) x 1" (2.5 cm)
- 11-244 MEYERDING Retractor 9½" (24.1 cm), small blade, 2" (5.1 cm) x ¾" (1.6 cm)
- 11-246 RICHARDSON Retractor 9½" (24.1 cm), Loop Handle, 1" (2.5 cm) x ¾" (1.9 cm)
- 11-247 RICHARDSON Retractor 9½" (24.1 cm), Loop Handle, 1¼" (3.2 cm) x 1" (2.5 cm)
- 11-248 RICHARDSON Retractor 9½" (24.1 cm), Loop Handle, 1½" (3.8 cm) x 1½" (3.8 cm)
- 11-249 RICHARDSON Retractor 9½" (24.1 cm), Loop Handle, 2" (5.1 cm) x ¾" (1.9 cm)
- 11-250 RICHARDSON Retractor 9½" (24.1 cm), Hollow Grip Handle, 1" (2.5 cm) x ¾" (1.9 cm)
- 11-252 RICHARDSON Retractor 9½" (24.1 cm), Hollow Grip Handle, 1¼" (3.2 cm) x 1" (2.5 cm)
- 11-254 RICHARDSON Retractor 9½" (24.1 cm), Hollow Grip Handle, 1½" (3.8 cm) x 1" (2.5 cm)
- 11-256 RICHARDSON Retractor 9½" (24.1 cm), Hollow Grip Handle, 2" (5.1 cm) x ¾" (1.9 cm)

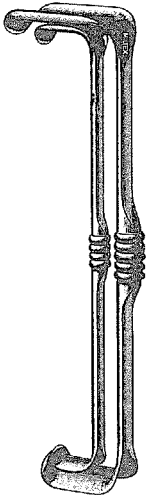

11-260 to 11-260B

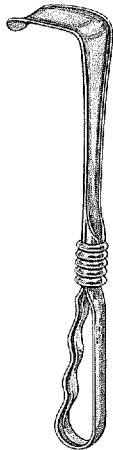

11-266 to 11-269

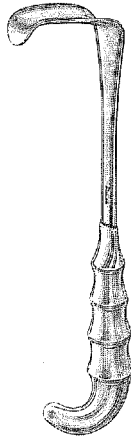

11-270 to 11-274

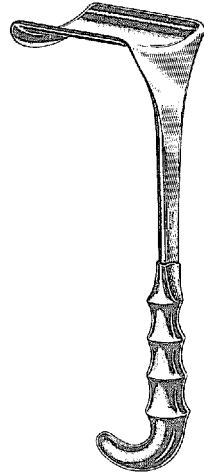

11-276

- 11-260** RICHARDSON-EASTMAN Retractor, double end, set of two
11-260A RICHARDSON-EASTMAN Retractor, double end, 11" (27.9 cm), large size
11-260B RICHARDSON-EASTMAN Retractor, double end, 10" (25.4 cm), small size
- 11-266** KELLY Retractor 9¾" (24.8 cm), Loop Handle, 2" (5.1 cm) x 1½" (3.8 cm)
11-267 KELLY Retractor 9¾" (24.8 cm), Loop Handle, 2½" (6.4 cm) x 2" (5.1 cm)
11-268 KELLY Retractor 9¾" (24.8 cm), Loop Handle, 3" (7.6 cm) x 2½" (6.4 cm)
11-269 KELLY Retractor 9¾" (24.8 cm), Loop Handle, 3½" (8.9 cm) x 2¾" (7 cm)
- 11-270** KELLY Retractor 9½" (24.1 cm), Hollow Grip Handle, 2" (5.1 cm) x 1½" (3.8 cm)
11-272 KELLY Retractor 10" (25.4 cm), Hollow Grip Handle, 2½" (6.4 cm) x 2" (5.1 cm)
11-274 KELLY Retractor 10" (25.4 cm), Hollow Grip Handle, 3" (7.6 cm) x 2½" (6.4 cm)
11-276 KELLY Retractor 10" (25.4 cm), Hollow Grip Handle, 3½" (8.9 cm) x 2¾" (7 cm)

Retractors

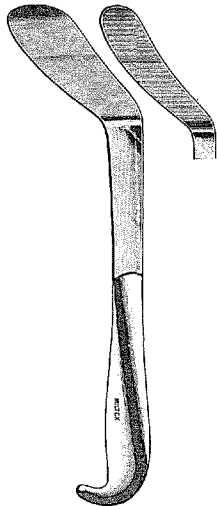

11-290
11-292

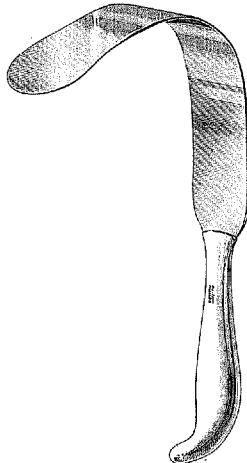

11-300

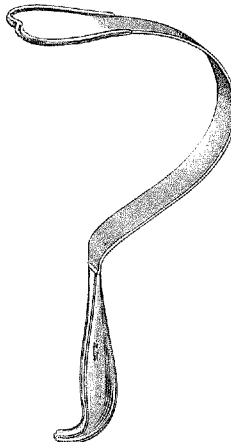

11-314 to 11-318



11-342

- 11-290 MURPHY Gall Bladder Retractor 10½" (26.7 cm), blade 1¼" (3.2 cm) wide
11-292 MURPHY Gall Bladder Retractor 10½" (26.7 cm), blade 2" (5.1 cm) wide
11-300 FOSS Gall Bladder Retractor 10" (25.4 cm), blade 1¾" (4.4 cm) wide
11-314 HARRINGTON Retractor 12" (30.5 cm), blade 2½" (6.4 cm) wide
11-316 HARRINGTON Retractor 12" (30.5 cm), blade 1½" (3.8 cm) wide
11-318 HARRINGTON Retractor 9½" (24.1 cm), blade 1" (2.5 cm) wide
11-342 FRITSCH Abdominal Retractor 9½" (24.1 cm), Hollow Grip Handle, 3" (7.6 cm) blade



Retractors

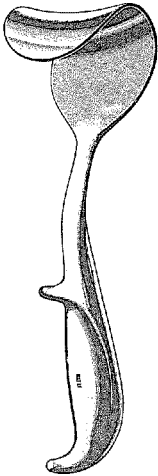

11-346



25-302

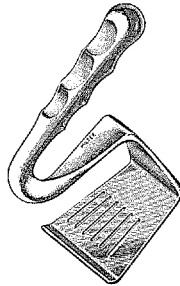

25-306

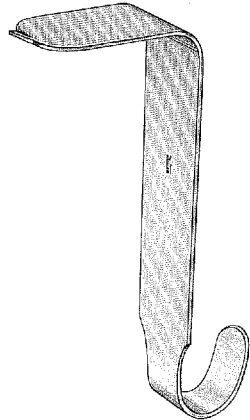

26-91
26-92

- 11-346 MAYO Abdominal Retractor 10" (25.4 cm), blade 2¾" (7 cm) wide
- 25-302 ALLISON Lung Retractor 12¾" (32.4 cm), standard size 2" (5.1 cm) wide blade
- 25-306 DAVIDSON Scapula Retractor, blade 3½" (8.9 cm) wide x 3¼" (8.3 cm) deep
- 26-91 TAYLOR Spinal Retractor 7¼" (18.4 cm), blade 1¼" (3.2 cm) x 3" (7.6 cm)
- 26-92 TAYLOR Spinal Retractor 8" (20.3 cm), blade 1¼" (3.2 cm) x 4" (10.2 cm)



28-70 to 28-74

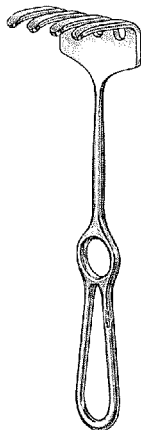

11-349

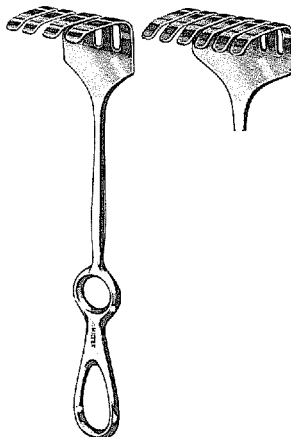

11-350
11-352

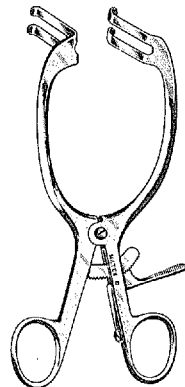

11-360

- 28-70 SAWYER Retractor 11" (27.9 cm), blade $\frac{7}{8}$ " (2.2 cm) x $2\frac{1}{2}$ " (6.4 cm)
- 28-72 SAWYER Retractor 11" (27.9 cm), blade $1\frac{1}{8}$ " (2.8 cm) x 3" (7.6 cm)
- 28-74 SAWYER Retractor 11" (27.9 cm), blade $1\frac{1}{2}$ " (3.8 cm) x $3\frac{1}{2}$ " (8.9 cm)
- 11-349 OLLIER Retractor $8\frac{1}{2}$ " (21.6 cm), blunt, 4 prongs $2\frac{1}{4}$ " (5.7 cm) x $1\frac{3}{4}$ " (4.4 cm)
- 11-350 ISRAEL Retractor 9" (22.9 cm), blunt, 4 prongs $1\frac{1}{2}$ " (3.8 cm) x $1\frac{5}{8}$ " (4.1 cm)
- 11-352 ISRAEL Retractor 9" (22.9 cm), blunt, 6 prongs $2\frac{1}{4}$ " (5.7 cm) x $1\frac{3}{4}$ " (4.4 cm)
- 11-360 MAYO-ADAMS Retractor $6\frac{3}{4}$ " (17.1 cm), with grip lock
- 11-362 MAYO-ADAMS Retractor $6\frac{3}{4}$ " (17.1 cm), with center blade and grip lock

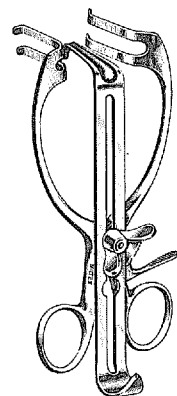

11-362

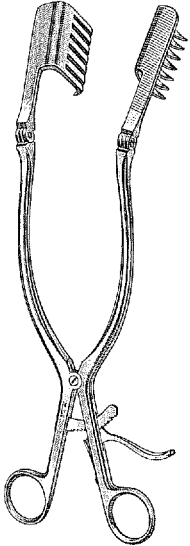

26-1973

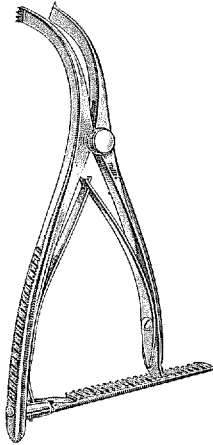

26-2000
26-2001
26-2005

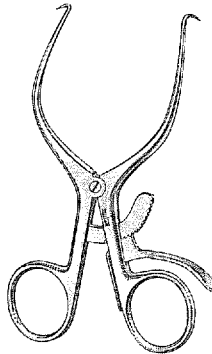

11-365
11-366

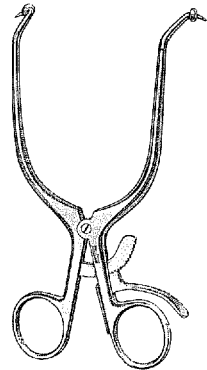

11-368

- 26-1973** BECKMAN-EATON Laminectomy Retractor 12 $\frac{3}{4}$ " (32.4 cm), hinged, sharp 7 x 7 teeth 1 $\frac{1}{4}$ " (4.4 cm) wide x 2" (5.1 cm) deep
- 26-2000** INGE Lamina Spreader 6" (15.2 cm), jaws open to 1 $\frac{1}{8}$ " (2.8 cm)
- 26-2001** INGE Lamina Spreader 6" (15.2 cm), jaws open to 1 $\frac{1}{8}$ " (2.8 cm), without teeth
- 26-2005** INGE Lamina Spreader 9 $\frac{1}{2}$ " (24.1 cm), jaws open to 1 $\frac{1}{4}$ " (4.4 cm), smooth handles
- 11-365** Pediatric GELPI Retractor 5 $\frac{1}{2}$ " (14 cm), with grip lock
- 11-366** GELPI Retractor 6 $\frac{3}{4}$ " (17.1 cm), with grip lock
- 11-368** GELPI Retractor 6 $\frac{3}{4}$ " (17.1 cm), with ball stops and grip lock
- 11-374** RIGBY Appendectomy Retractor 6 $\frac{3}{4}$ " (17.1 cm), with grip lock

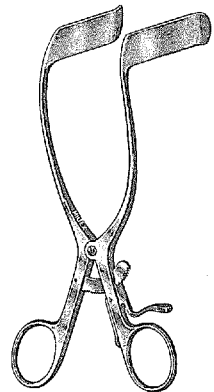

11-374

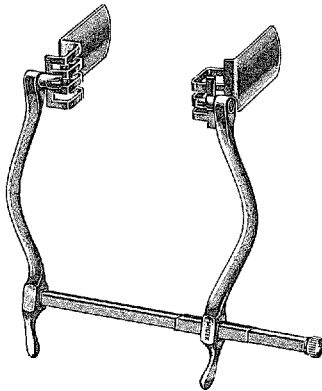

11-390

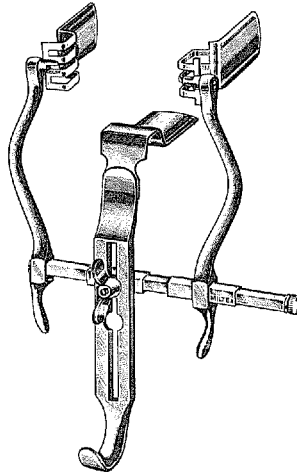

11-392

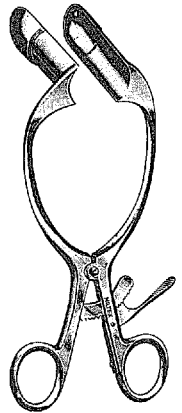

28-6

11-390 MASSON-JUDD Bladder Retractor with 2 swivel blades 1" (2.5 cm) x 2¾" (7 cm)

11-392 MASSON-JUDD Bladder Retractor with 2 swivel blades and center blade 1" (2.5 cm) x 2¾" (7 cm)

28-6 BARR Anal Retractor 8" (20.3 cm), self-retaining, blades 2¾" (7 cm) x ⅞" (2.2 cm)

28-8 COOK Rectal Retractor 8" (20.3 cm), triple bladed, self-retaining, 4" (10.2 cm) deep blades, lower blade ½" (1.3 cm) wide

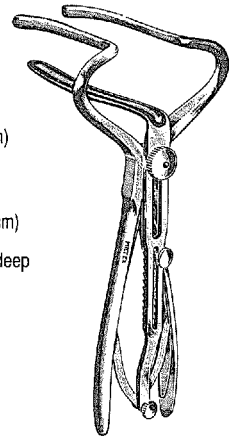

28-8

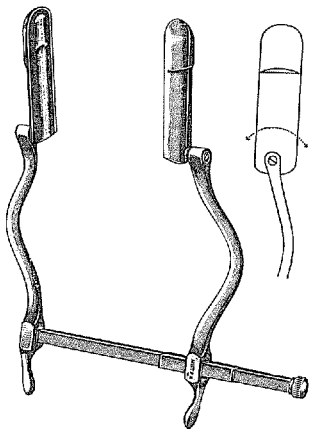

28-64
28-65

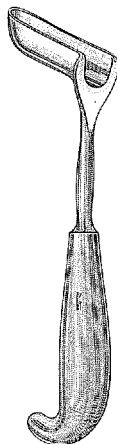

28-68
28-69

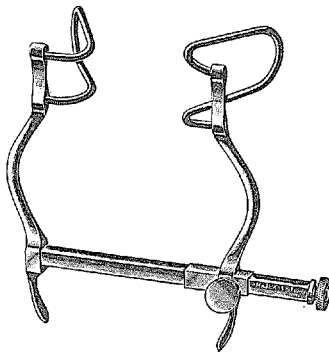

11-400 to 11-404

- 28-64** SMITH (BUIE) Anal Retractor, self-retaining, swivel blades $2\frac{1}{2}$ " (6.4 cm) x $\frac{7}{8}$ " (2.2 cm) open to 4" (10.2 cm)
- 28-65** SMITH (BUIE) Anal Retractor, self-retaining, extra long swivel blades 4" (10.2 cm) x $\frac{7}{8}$ " (2.2 cm) open to 4" (10.2 cm)
- 28-68** HILL-FERGUSON Retractor $8\frac{1}{2}$ " (21.6 cm), small blade 2.2 x 6.4 cm
- 28-69** HILL-FERGUSON Retractor $8\frac{3}{4}$ " (21 cm), large blade 3 x 7.6 cm
- 11-400** GOSSET Retractor 4" (10.2 cm) spread, 1" (2.5 cm) x $1\frac{1}{2}$ " (3.8 cm) blades
- 11-402** GOSSET Retractor $5\frac{1}{2}$ " (14 cm) spread, 1" (2.5 cm) x $2\frac{1}{2}$ " (6.4 cm) blades
- 11-404** Pediatric GOSSET Retractor $3\frac{1}{2}$ " (8.9 cm) spread, $\frac{3}{4}$ " (1.9 cm) x 1" (2.5 cm) blades, light pattern

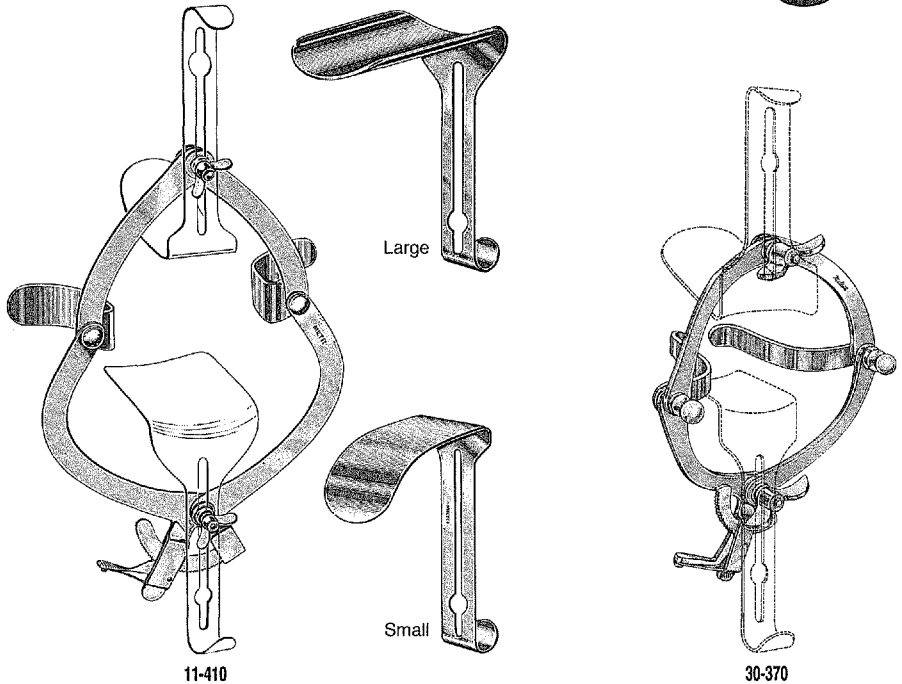

11-410 O'SULLIVAN-O'CONNOR Abdominal Retractor, with 3 interchangeable blades, two small size $1\frac{1}{4}$ " (4.4 cm) x $3\frac{1}{4}$ " (8.3 cm), one large size $2\frac{3}{4}$ " (7 cm) x $4\frac{1}{4}$ " (10.8 cm)

30-370 O'SULLIVAN-O'CONNOR Vaginal Retractor, with 3 interchangeable blades, $\frac{1}{2}$ " (1.3 cm) x $1\frac{7}{8}$ " (4.7 cm), $1\frac{1}{2}$ " (3.8 cm) x $3\frac{1}{2}$ " (8.9 cm) and $1\frac{3}{4}$ " (4.4 cm) x $3\frac{1}{2}$ " (8.9 cm)

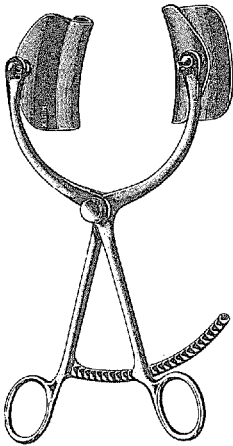

11-414

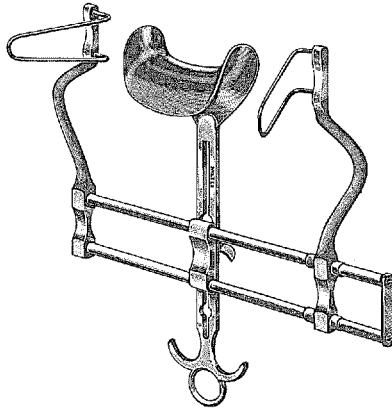

11-420

11-421

11-414 COLLIN Abdominal Retractor 9" (22.9 cm), with 2 swivel blades

BALFOUR ABDOMINAL RETRACTORS
with fenestrated side blades 2½" (6.4 cm) deep and solid center blade 3" (7.6 cm) x 1¾" (4.4 cm) deep

11-420 7" (17.8 cm) spread (standard size)

11-421 10" (25.4 cm) spread

11-424 BALFOUR Abdominal Retractor, with solid side blades 2¾" (7 cm) deep and solid center blade 3" (7.6 cm) x 1¾" (4.4 cm) deep, 7" (17.8 cm) spread

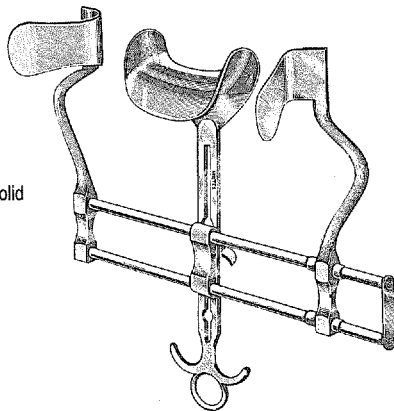

11-424

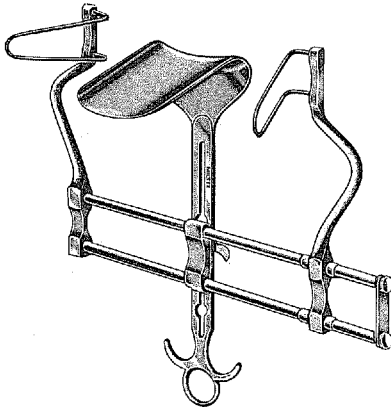

11-428

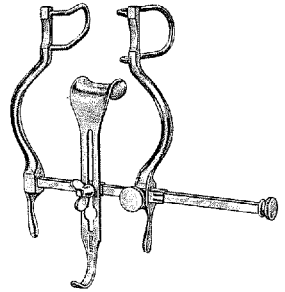

11-430

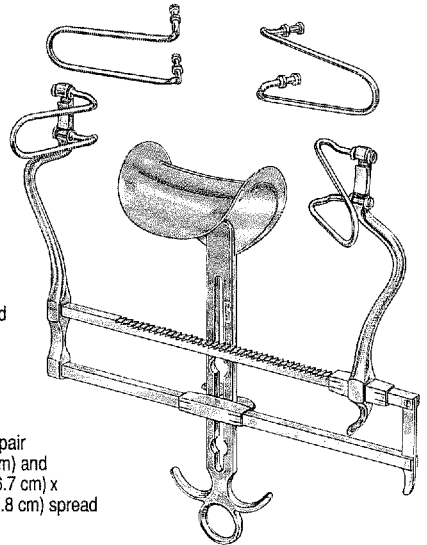

11-432

- 11-428 BALFOUR Abdominal Retractor, with fenestrated side blades 4" (10.2 cm) deep solid center blade 2¾" (7 cm) x 4" (10.2 cm) deep, 7" (17.8 cm) spread
- 11-430 Pediatric BALFOUR Abdominal Retractor, with fenestrated side blades and solid center blade 1" (2.5 cm) deep, 4" (10.2 cm) spread, light pattern
- 11-432 BALFOUR Abdominal Retractor with ratchet bar, 2 pair interchangeable fenestrated side blades 2½" (5.7 cm) and 3½" (8.9 cm) deep and 2 solid center blades 2¾" (6.7 cm) x 1¾" (4.4 cm) and 3¼" (8.3 cm) x 2¾" (7 cm), 7" (17.8 cm) spread

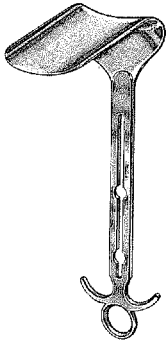

11-442

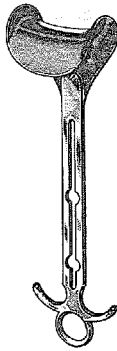

11-440
11-444
11-446

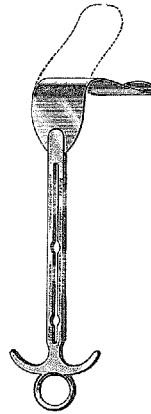

11-448

- 11-440 BALFOUR Center Blade, standard size 3" (7.6 cm) x 1 $\frac{1}{4}$ " (4.4 cm) deep
- 11-442 BALFOUR Center Blade, extra deep model, 2 $\frac{3}{4}$ " (7 cm) x 4" (10.2 cm) deep
- 11-444 BALFOUR Center Blade, 2 $\frac{5}{8}$ " (6.7 cm) x 1 $\frac{3}{4}$ " (4.4 cm) deep
- 11-446 BALFOUR Center Blade, 3 $\frac{1}{4}$ " (8.3 cm) x 2 $\frac{3}{4}$ " (7 cm) deep
- 11-448 BALFOUR Center Blade, 2" (5.1 cm) x 5" (12.7 cm) deep, malleable

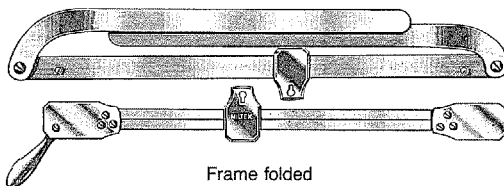
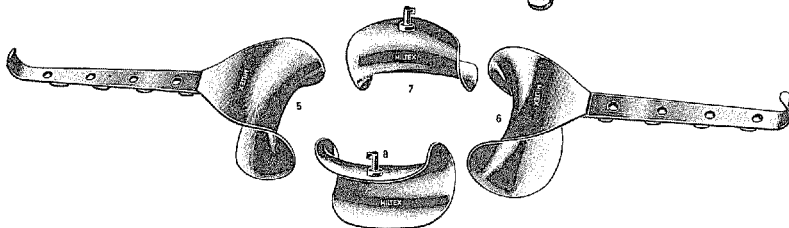
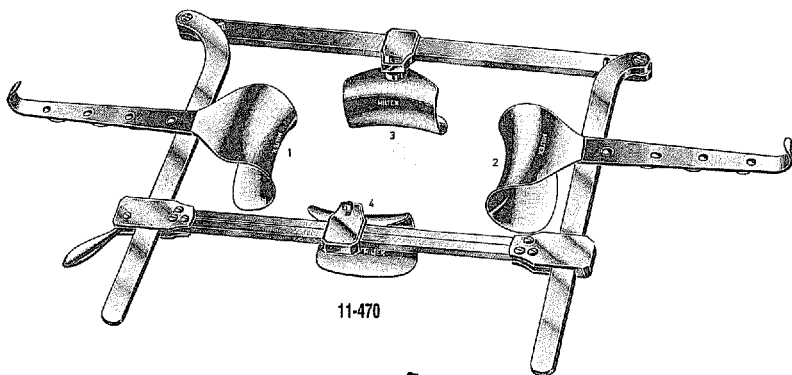

11-470 FRANZ Abdominal Retractor, with 8 interchangeable blades, folding for easy storage.

Blades No. 1 and 2 – 2" (5.1 cm) x 1¼" (4.4 cm) deep

Blades No. 3 and 4 – 2½" (6.4 cm) x 1¼" (3.2 cm) deep

Blades No. 5 and 6 – 3" (7.6 cm) x 2" (5.1 cm) deep

Blades No. 7 and 8 – 3½" (8.9 cm) x 1¼" (3.2 cm) deep



Retractors



11-500

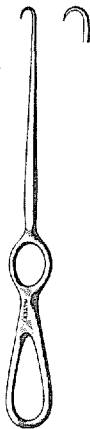

11-502



27-230
27-232

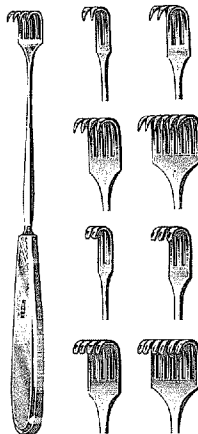

11-504 to 11-516



11-530 to 11-544

- 11-500 VOLKMAN Hook 8½" (21.6 cm), sharp, hollow handle
- 11-502 VOLKMAN Hook 8½" (21.6 cm), sharp, ring handle
- 27-230 VOLKMAN Hook Retractor 9" (22.9 cm), sharp point 15 mm deep
- 27-232 VOLKMAN Hook Retractor 9" (22.9 cm), blunt tip 15 mm deep

VOLKMAN RETRACTORS 8½" (21.6 cm), Hollow Handle

Sharp		Blunt
11-504	2 prongs	11-512
11-506	3 prongs	11-514
11-508	4 prongs	11-516

VOLKMAN RETRACTORS 8" (20.3 cm), Ring Handle

Sharp		Blunt
11-530	2 prongs	11-538
11-532	3 prongs	11-540
11-534	4 prongs	11-542
11-536	6 prongs	11-544

Retractors

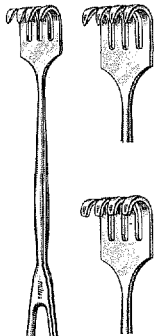

11-546 to 11-554

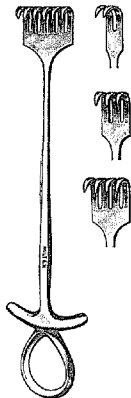

11-560 to 11-566

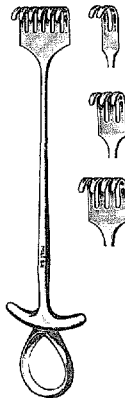

11-568 to 11-574

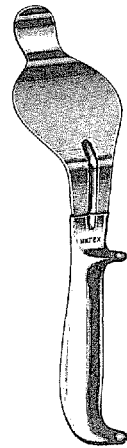

11-580
11-582

VOLKMAN RETRACTORS 8¾" (22.2 cm), USA Pattern Ring Handle

Sharp		Blunt
11-546	2 prongs	11-551
11-547	3 prongs	11-552
11-548	4 prongs	11-553
11-549	6 prongs	11-554

MURPHY RETRACTORS 7½" (19.1 cm)

Sharp		Blunt
11-560	2 prongs	11-568
11-562	3 prongs	11-570
11-564	4 prongs	11-572
11-566	6 prongs	11-574

11-580 BENNETT Tibia Retractor 9½" (24.1 cm), small blade 1¾" (4.4 cm) wide

11-582 BENNETT Tibia Retractor 9½" (24.1 cm), large blade 2½" (6.4 cm) wide

11-590 HIBBS Retractor 9¼" (23.5 cm), blade 1" (2.5 cm) x 3" (7.6 cm) deep

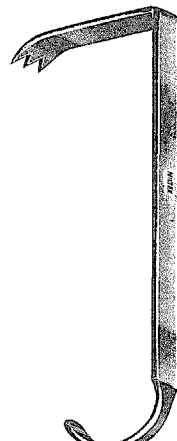

11-590



Retractors



27-213
27-214



27-215 to 27-218

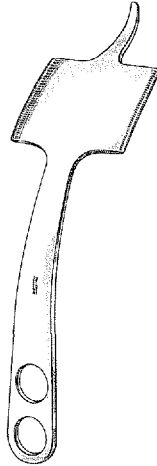

27-219



27-223

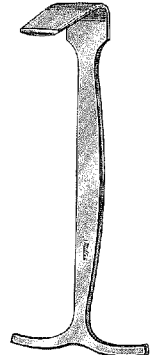

27-224

- 27-213 MINI-HOHMANN Retractor 6 $\frac{1}{4}$ " (15.9 cm), blade 6 mm wide
27-214 MINI-HOHMANN Retractor 6 $\frac{1}{4}$ " (15.9 cm), blade 8 mm wide
27-215 HOHMANN Retractor 9 $\frac{1}{4}$ " (23.5 cm), blade 10 mm wide
27-216 HOHMANN Retractor 9 $\frac{1}{4}$ " (23.5 cm), blade 18 mm wide
27-217 HOHMANN Retractor 9 $\frac{1}{4}$ " (23.5 cm), blade 25 mm wide
27-218 HOHMANN Retractor 9 $\frac{1}{4}$ " (23.5 cm), blade 43 mm wide
27-219 HOHMANN Retractor 9 $\frac{3}{4}$ " (24.8 cm), blade 70 mm wide
27-223 BLOUNT Knee Retractor 7" (17.8 cm), blade 1 $\frac{1}{4}$ " (4.4 cm) deep, $\frac{5}{8}$ " (1.6 cm) wide tapering to $\frac{3}{16}$ " (.48 cm)
27-224 SMILLIE Meniscus Hook Retractor 5 $\frac{3}{4}$ " (14.6 cm), blade $\frac{3}{4}$ " (1.9 cm) x 1 $\frac{1}{8}$ " (3.5 cm)
27-225 HAYS Hand and Finger Retractor 6" (15.2 cm), angled blade 1 $\frac{1}{2}$ " (3.8 cm) long, $\frac{3}{8}$ " (1 cm) wide tapering to $\frac{1}{8}$ " (.32 cm)



27-225

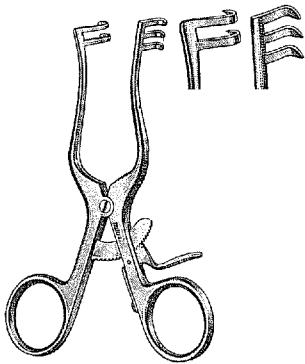

11-600 to 11-602

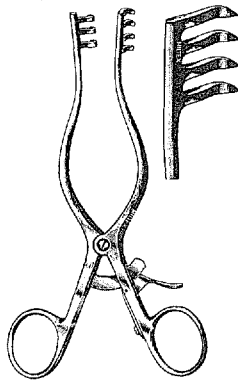

11-608 to 11-610
11-614 to 11-622

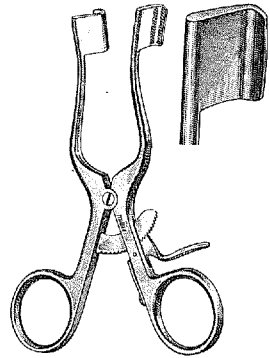

11-611

WEITLANER RETRACTORS

Sharp	Size	Blunt
11-600	4" (10.2 cm) 2 x 3 teeth	11-602
11-608	5½" (14 cm) 3 x 4 teeth	11-610
—	5½" (14 cm) solid blades	11-611
11-614	6½" (16.5 cm) 3 x 4 teeth	11-616
11-617	8" (20.3 cm) 3 x 4 teeth	11-618
11-620	9½" (24.1 cm) 3 x 4 teeth	11-622

BECKMAN-WEITLANER RETRACTORS with Hinged Blades

Sharp	Size	Blunt
11-630-SH	5½" (14 cm) 3 x 4 teeth	11-630-BL
11-634-SH	6½" (16.5 cm) 3 x 4 teeth	11-634-BL
11-642-SH	9" (22.9 cm) 3 x 4 teeth	11-642-BL

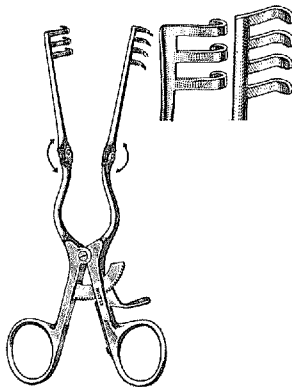

11-630 to 11-642

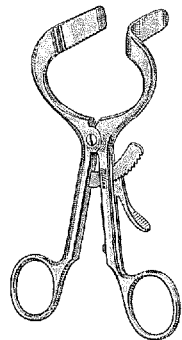

40-1235

40-1235 SCHINK Retractor 4½" (11.4 cm)

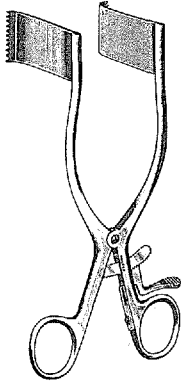

11-650 to 11-656

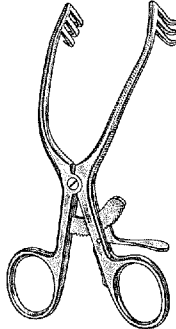

19-655

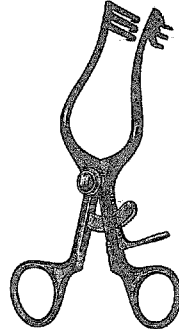

19-660

MEYERDING SELF-RETAINING RETRACTORS

- 11-650 1" (2.5 cm) x 2 $\frac{3}{8}$ " (6.1 cm) blades
- 11-652 1" (2.5 cm) x 2 $\frac{1}{8}$ " (5.4 cm) blades
- 11-654 1" (2.5 cm) x 1 $\frac{1}{4}$ " (4.4 cm) blades
- 11-656 $\frac{3}{4}$ " (1.9 cm) x 2 $\frac{3}{8}$ " (6.1 cm) blades
- 19-655 SCHUHKNECHT Postauricular Retractor 5" (12.7 cm),
3 x 3 teeth, 3" (7.6 cm) opening
- 19-660 WULLSTEIN Endaural Retractor 5" (12.7 cm),
3 x 3 sharp teeth, ebony non-glare finish
- 19-668 PERKINS Endaural Retractor 5 $\frac{1}{4}$ " (13.3 cm),
left serrated solid blade, right side 3 teeth
- 19-669 PERKINS Endaural Retractor 5 $\frac{1}{4}$ " (13.3 cm),
right serrated solid blade, left side 3 teeth

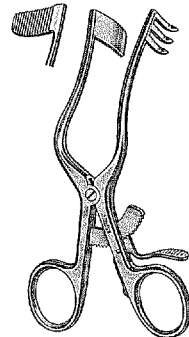

19-668

19-669

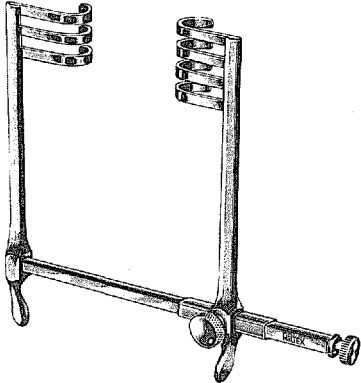

11-660

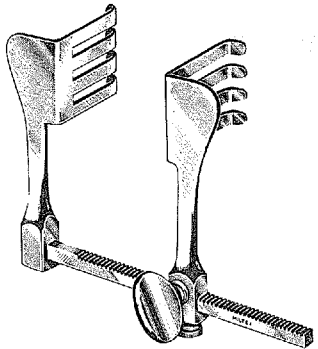

11-672

- 11-660 FRAZIER Retractor, 3 x 4 blunt teeth, 3¼" (8.3 cm) spread
- 11-672 BADGLEY Retractor, 4 x 4 blunt teeth, 2" (5.1 cm) x 1¼" (4.4 cm), 6½" (16.5 cm) spread
- 11-676 TUFFIER Retractor, 2" (5.1 cm) x 1¼" (4.4 cm), grooved blades, 6½" (16.5 cm) spread

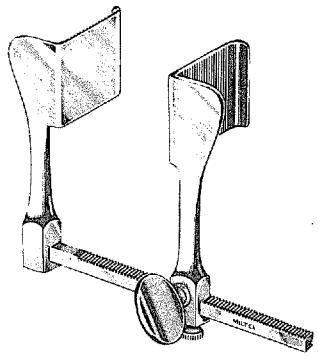

11-676

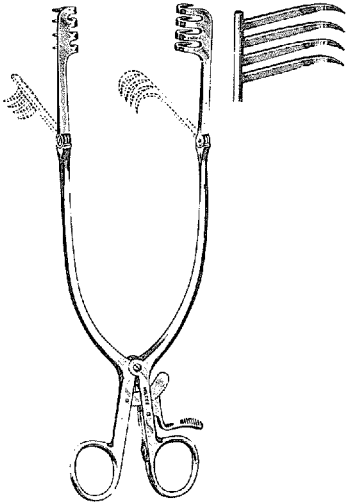

11-684
11-686

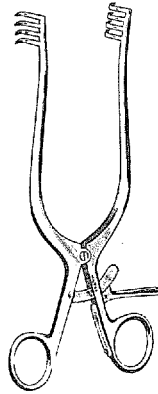

11-700

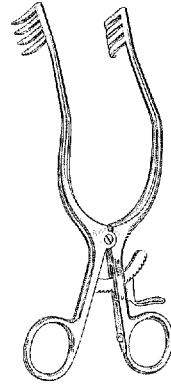

11-702

- 11-684 BECKMAN Retractor 12½" (31.8 cm), hinged, sharp
4 x 4 teeth ¾" (1.9 cm) x 1" (2.5 cm)
- 11-686 BECKMAN Retractor 12½" (31.8 cm), hinged, sharp
4 x 4 teeth 1¾" (4.4 cm) x 1¼" (3.2 cm)
- 11-700 ADSON Retractor 7½" (19.1 cm), sharp, 4 x 4 teeth
¾" (1.9 cm) x ¾" (1.9 cm), straight arms
- 11-702 ADSON Retractor 7½" (19.1 cm), sharp, 4 x 4 teeth
¾" (1.9 cm) x ¾" (1.9 cm), angled arms
- 30-1355 Lateral Vaginal Retractor 8¼" (21 cm), with extra long
thumb ratchet retracts up to a full 2¼" (5.7 cm) for an
extra wide viewing area

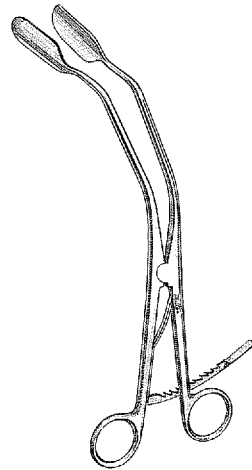

30-1355



11-82



11-500

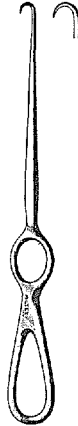

11-502



27-230
27-232



18-412
18-414



18-416

- 11-82 MEYERDING Skin Hook and Retractor 6¼" (15.9 cm), double end
- 11-500 VOLKMAN Hook 8½" (21.6 cm), sharp, hollow handle
- 11-502 VOLKMAN Hook 8½" (21.6 cm), sharp, ring handle
- 27-230 VOLKMAN Hook Retractor 9" (22.9 cm), sharp point 15 mm deep
- 27-232 VOLKMAN Hook Retractor 9" (22.9 cm), blunt tip 15 mm deep
- 18-412 TYRELL Hook 5" (12.7 cm), sharp
- 18-414 TYRELL Hook 5" (12.7 cm), blunt
- 18-416 GUTHRIE Fixation Hook 5" (12.7 cm), sharp double prongs 1.5 mm wide

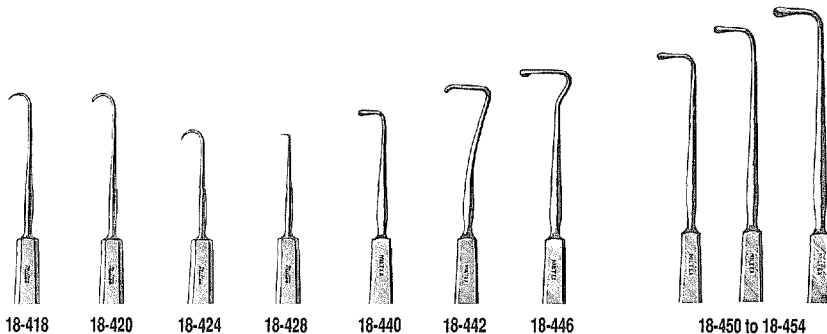

- 18-418** WIENER Hook 5" (12.7 cm), sharp
- 18-420** WIENER Hook 5" (12.7 cm), blunt
- 18-424** O'CONNOR Hook 4¾" (12.1 cm), sharp
- 18-428** NUGENT Hook 4¾" (12.1 cm), right angle, sharp
- 18-440** STEVENS Hook 5" (12.7 cm), right angle 5 mm deep
- 18-442** GREEN Hook 5" (12.7 cm), 9 mm deep
- 18-446** JAMESON Hook 5" (12.7 cm), 10 mm deep
- 18-450** VON GRAEFE Hook 5½" (14 cm), small size 8 mm deep
- 18-452** VON GRAEFE Hook 5½" (14 cm), medium size 10 mm deep
- 18-454** VON GRAEFE Hook 5½" (14 cm), large size 11 mm deep



19-220
19-222



19-226



19-228

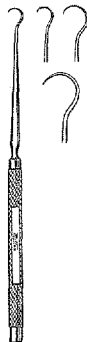

21-85 to 21-87



21-88
21-89



21-90 to 21-94

- 19-220 DAY Hook 6½" (16.5 cm), small size
- 19-222 DAY Hook 6½" (16.5 cm), large size
- 19-226 ALLPORT Hook 6½" (16.5 cm), with ball tip
- 19-228 GROSS Hook and Spoon 5" (12.7 cm)
- 21-85 KLEINERT-KUTZ Hook 5" (12.7 cm), small size 3 mm dia.
- 21-86 KLEINERT-KUTZ Hook 5" (12.7 cm), medium size 5 mm dia.
- 21-87 KLEINERT-KUTZ Hook 5" (12.7 cm), large size 7 mm dia.
- 21-88 GILLIES (CONVERSE) Skin Hook 7" (17.8 cm), large size
- 21-89 GILLIES (CONVERSE) Skin Hook 7" (17.8 cm), small size
- 21-90 COTTLE Skin Hook 5½" (14 cm), small, shallow curve
- 21-92 COTTLE Skin Hook 5½" (14 cm), small, deep curve
- 21-94 COTTLE Skin Hook 5½" (14 cm), large, deep curve
- 26-1084 FRAZIER Dura Hook 5" (12.7 cm), sharp point
- 26-1086 FRAZIER Dura Hook 5" (12.7 cm), blunt point



26-1084
26-1086



21-102
21-103

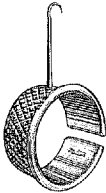

21-107

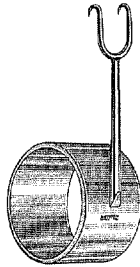

21-108



21-144



21-152



21-153

- 21-102 FREER Skin Hook 6" (15.2 cm), sharp double prongs 2.5 mm wide
 21-103 FREER Skin Hook 6" (15.2 cm), blunt double prongs 2.5 mm wide
 21-107 MILLARD Thimble Hook Retractor, 5/8" (1.6 cm) working length, sharp single hook
 21-108 COTTLE Thumb Hook Retractor, 1 1/2" (3.8 cm) working length, sharp double hook 8 mm wide
 21-144 COTTLE Double Hook 5 1/2" (14 cm), two sharp prongs 12 mm wide
 21-152 MILTEX Skin Hook 4 3/4" (12.1 cm), sharp prong 2 mm dia.
 21-153 JOSEPH Single Hook 6 1/4" (15.9 cm), one sharp prong
 21-154 JOSEPH Double Hook 6 1/4" (15.9 cm), two sharp prongs 2 mm
 21-156 JOSEPH Double Hook 6 1/4" (15.9 cm), two sharp prongs 5 mm
 21-158 JOSEPH Double Hook 6 1/4" (15.9 cm), two sharp prongs 7 mm
 21-160 JOSEPH Double Hook 6 1/4" (15.9 cm), two sharp prongs 10 mm

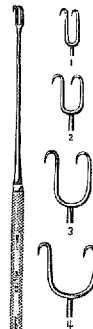

21-154 to 21-160



21-430



23-1048



23-1050



23-1051



26-1080



26-1090
26-1092

- 21-430 MILTEX Tissue Twist Hook 5½" (14 cm)
- 23-1048 HUPP Hook 6½" (16.5 cm), sharp point
- 23-1050 JACKSON Tenaculum Hook 5¾" (14.6 cm), sharp point
- 23-1051 NEWS Hook 6" (15.2 cm), sharp point
- 26-1080 CUSHING Dura Hook 6½" (16.5 cm), blunt
- 26-1090 ADSON Dura & Dissecting Hook 8" (20.3 cm), sharp blade 5 mm at right angle
- 26-1092 ADSON Dura Hook 8" (20.3 cm), blunt 5 mm hook at right angle

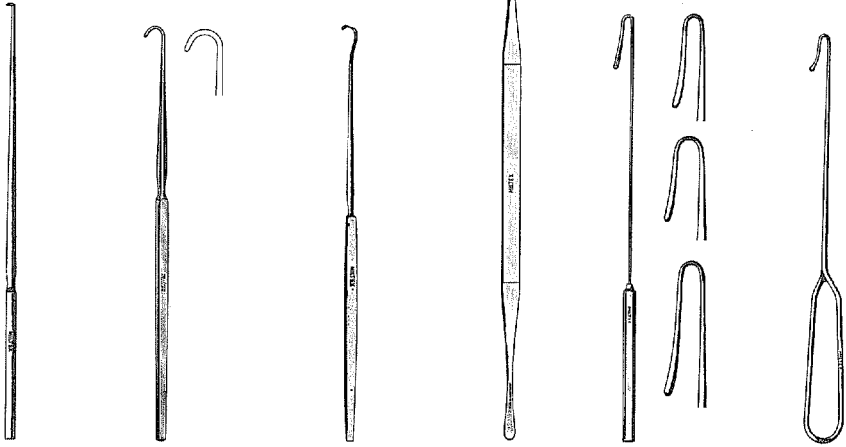

26-1150

26-1156

26-1170

26-1174

28-120 to 28-124

28-128
28-130

- 26-1150 DANDY Hook 9" (22.9 cm), straight
- 26-1156 GRAHAM Hook 7" (17.8 cm), blunt, 6 mm deep
- 26-1170 SMITHWICK Hook 7" (17.8 cm), blunt, 10 mm deep
- 26-1174 SMITHWICK Hook and Dissector 12" (30.5 cm)
- 28-120 PRATT Crypt Hook 8½" (21.6 cm), narrow style
- 28-122 PRATT Crypt Hook 8½" (21.6 cm), short style
- 28-124 PRATT Crypt Hook 8½" (21.6 cm), long style
- 28-128 STEWART Crypt Hook 8½" (21.6 cm), short style
- 28-130 STEWART Crypt Hook 8½" (21.6 cm), long style

Hooks



28-131



28-140



30-940



30-950

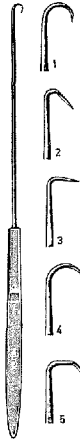

30-951 to 30-955

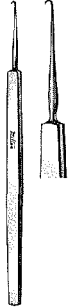

33-121

28-131 ROSSER Crypt Hook 6¾" (17.1 cm)

28-140 BARR Crypt Hook 10" (25.4 cm), short and long hook ends

30-940 MILTEX I.U.D. Extractor Hook 10¼" (26 cm)

30-950 MILTEX Tenaculum Hook 8" (20.3 cm), extra delicate pointed hook, handle graduated in cm

EMMETT TENACULUM HOOKS 9" (22.9 cm), Sharp Points

30-951 Style 1 Half-Curved, small **30-954** Style 4 Half-Curved, large

30-952 Style 2 Acute Angle **30-955** Style 5 Double Angle

30-953 Style 3 Right Angle

33-121 SELTZER Dermal Biopsy Hook 4½" (11.4 cm), sharp point

34-250 Dissecting Tenaculum Hook 6½" (16.5 cm), sharp point



34-250



11-20

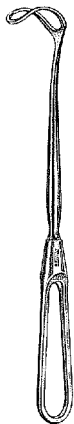

11-22



11-74
11-76



11-78



11-80
11-81

- 11-20 LAHEY Thyroid Retractor 7 $\frac{3}{4}$ " (19.7 cm)
- 11-22 GREEN Thyroid Retractor 8 $\frac{1}{2}$ " (21.6 cm)
- 11-74 SENN Retractor 6 $\frac{3}{8}$ " (16.2 cm), sharp, double end
- 11-76 SENN Retractor 6 $\frac{3}{8}$ " (16.2 cm), blunt, double end
- 11-78 CRILE Thyroid Retractor 4 $\frac{1}{2}$ " (11.4 cm), double end
3 x 11 mm and 6 x 20 mm blades
- 11-80 MATHIEU Retractor 6 $\frac{1}{2}$ " (16.5 cm), sharp, double end
- 11-81 MATHIEU Retractor 6 $\frac{1}{2}$ " (16.5 cm), blunt, double end
- 11-642-SH BECKMAN-WEITLANER Retractor 9" (22.9 cm),
hinged blades, sharp 3 x 4 teeth
- 11-642-BL BECKMAN-WEITLANER Retractor 9" (22.9 cm),
hinged blades, blunt 3 x 4 teeth

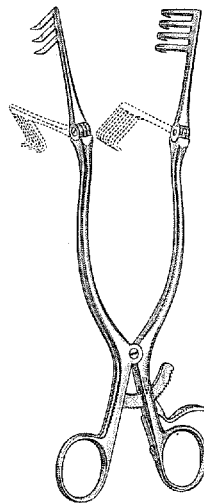

11-642-SH
11-642-BL

Thyroid-Goiter Instruments

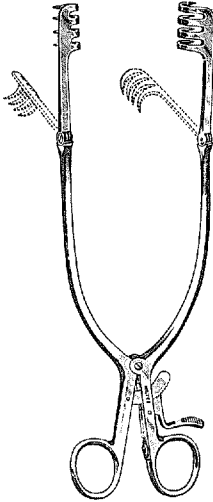

11-684

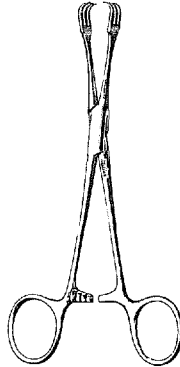

12-80



12-90

12-92

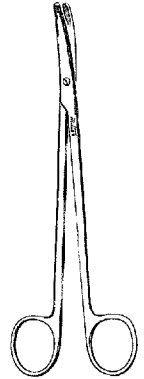

5-179

5-180

11-684 BECKMAN Thyroid Retractor 12½" (31.8 cm), hinged, sharp
4 x 4 teeth ¾" (1.9 cm) x 1" (2.5 cm)

12-80 LAHEY Traction Forceps 6½" (15.9 cm), 3 x 3 teeth

12-90 LAHEY Ligature Carrier 7½" (19.1 cm), curved left

12-92 LAHEY Ligature Carrier 7½" (19.1 cm), curved right

5-179 LAHEY Goiter Scissors 5½" (14 cm), straight

5-180 LAHEY Goiter Scissors 5½" (14 cm), curved

7-30 PROVIDENCE HOSPITAL Hemostatic Forceps 5½" (14cm), straight

7-32 PROVIDENCE HOSPITAL Hemostatic Forceps 5½" (14cm), curved

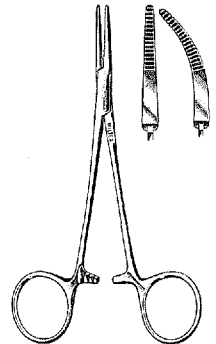

7-30

7-32

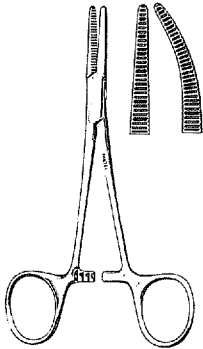

7-60
7-62

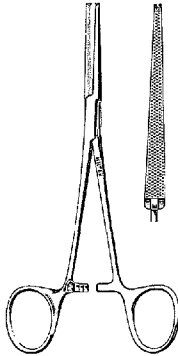

7-98

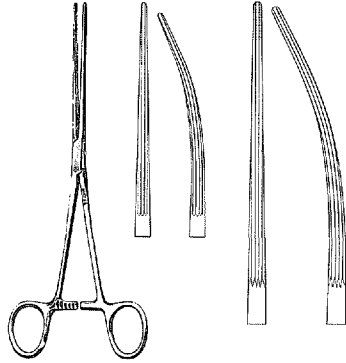

7-230 to 7-236

- 7-60 LAHEY Hemostatic Forceps 5½" (14 cm), straight
- 7-62 LAHEY Hemostatic Forceps 5½" (14 cm), curved
- 7-98 LOVELACE Hemostatic Forceps 6¼" (15.9 cm), straight, cross serrations, 1 x 2 teeth
- 7-230 BAINBRIDGE Hemostatic Forceps 6" (15.2 cm), straight, longitudinal serrations with cross tip serrations
- 7-232 BAINBRIDGE Hemostatic Forceps 6" (15.2 cm), curved, longitudinal serrations with cross tip serrations
- 7-234 BAINBRIDGE Hemostatic Forceps 7¼" (18.4 cm), straight, longitudinal serrations with cross tip serrations
- 7-236 BAINBRIDGE Hemostatic Forceps 7¼" (18.4 cm), curved, longitudinal serrations with cross tip serrations
- 12-170 MASTIN Muscle Clamp 7" (17.8 cm), shanks curved to side, one smooth and one serrated jaw, with four pins

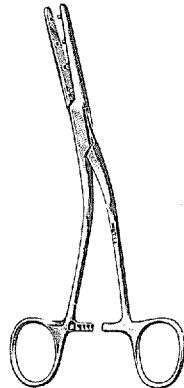

12-170

Trocars and Biopsy Needles

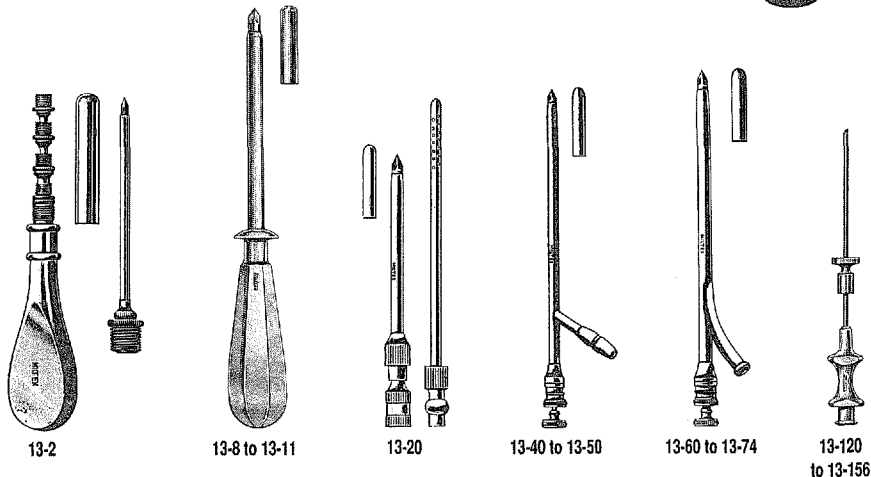

13-2 NESTED TROCAR SET of 4, sizes 6 French (2 mm), 9 French (3 mm), 13 French (4.3 mm) and 17 French (5.7 mm), in flat chrome plated handle. Trocar points and cannula are stainless.

PATTERSON TROCARS 8½" (21.6 cm). Trocar points, Cannula and handle are stainless

13-8	size 1	6 mm dia.
13-9	size 2	7.5 mm dia.
13-10	size 3	10.5 mm dia.
13-11	size 4	12 mm dia.

13-20 DUKE Trocar and Cannula 4½" (11.4 cm), with perforated tube, 5½" (13 cm) long, size 17 French (5.7 mm), all stainless

OCHSNER TROCARS, Original Model
6" (15.2 cm), with tubing connection

13-40	12 French (4 mm)	13-46	20 French (6.7 mm)
13-42	14 French (4.7 mm)	13-48	22 French (7.3 mm)
13-44	17 French (5.7 mm)	13-50	24 French (8 mm)

OCHSNER TROCARS, Improved Philadelphia Pattern,
6¼" (15.9 cm) for introduction of catheters

13-60	12 French (4 mm)	for 8 Fr. (2.7 mm) catheters
13-62	14 French (4.7 mm)	for 10 Fr. (3.3 mm) catheters
13-64	16 French (5.3 mm)	for 12 Fr. (4 mm) catheters
13-66	18 French (6 mm)	for 14 Fr. (4.7 mm) catheters
13-68	20 French (6.7 mm)	for 16 Fr. (5.3 mm) catheters
13-70	22 French (7.3 mm)	for 18 Fr. (6 mm) catheters
13-72	24 French (8 mm)	for 20 Fr. (6.7 mm) catheters
13-74	28 French (9.3 mm)	for 22 Fr. (7.3 mm) catheters

MENGHINI BIOPSY NEEDLES,

Improved Model, with built-in stop plug that never requires replacement

For Liver Biopsy	
Child Size - 40 mm long	
	inside diameter
13-120	1 mm - 19 gauge
13-122	1.2 mm - 18 gauge
13-124	1.4 mm - 17 gauge
13-126	1.6 mm - 16 gauge

For Liver Biopsy	
Adult Size - 70 mm long	
	inside diameter
13-128	1 mm - 19 gauge
13-130	1.2 mm - 18 gauge
13-132	1.4 mm - 17 gauge
13-134	1.8 mm - 16 gauge

For Kidney Biopsy	
120 mm long	
	inside diameter
13-150	1 mm - 19 gauge
13-152	1.2 mm - 18 gauge
13-154	1.4 mm - 17 gauge
13-156	1.8 mm - 16 gauge



Gall Bladder Instruments



14-2



14-4



14-8
14-10

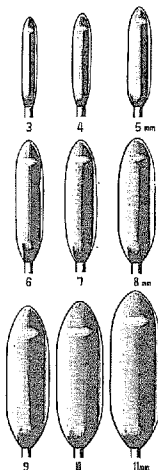

14-12

14-2 OCHSNER (FENGER) Gall Duct Probe, cannulated flexible spiral 14" (35 cm) with stylet

14-4-15 MAYO Common Duct Probe 10" (25.4 cm), malleable shaft, 15 French (5 mm)

14-4-18 MAYO Common Duct Probe 10" (25.4 cm), malleable shaft, 18 French (6 mm)

14-8 BAKES Common Duct Dilator Set; fitted plastic case containing 9 dilators sizes 3 to 11 mm, malleable shafts

BAKES COMMON DUCT DILATORS 8 3/4" (22.2 cm), single sizes, malleable shafts

14-10-3	3 mm dia.	14-10-8	8 mm dia.
14-10-4	4 mm dia.	14-10-9	9 mm dia.
14-10-5	5 mm dia.	14-10-10	10 mm dia.
14-10-6	6 mm dia.	14-10-11	11 mm dia.
14-10-7	7 mm dia.		

14-12 MIXTER Irrigating Dilaprobe 12" (30.5 cm), malleable, with Luer Lock, silver plated

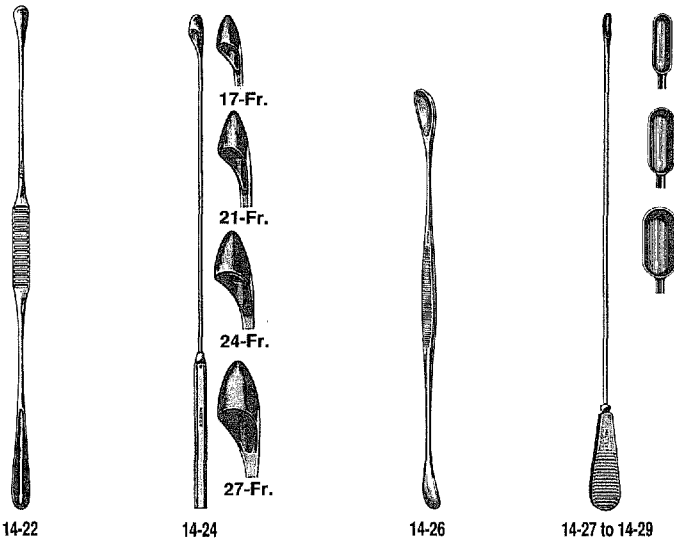

- 14-22** MAYO Gall Stone Scoop 11" (27.9 cm), double end
- 14-24-17** DESJARDIN Gall Stone Scoop 11" (27.9 cm), malleable shaft, 17 French (5.7 mm)
- 14-24-21** DESJARDIN Gall Stone Scoop 11" (27.9 cm), malleable shaft, 21 French (7 mm)
- 14-24-24** DESJARDIN Gall Stone Scoop 11" (27.9 cm), malleable shaft, 24 French (8 mm)
- 14-24-27** DESJARDIN Gall Stone Scoop 11" (27.9 cm), malleable shaft, 27 French (9 mm)
- 14-26-L** FERGUSON Gall Stone Scoop 9½" (24.1 cm), double end, large size scoops ½" (1.3 cm) x 1¼" (3.2 cm) and 7/16" (1.1 cm) x 1" (2.5 cm)
- 14-26-M** FERGUSON Gall Stone Scoop 9½" (24.1 cm), double end, medium size scoops ½" (1.3 cm) x 1½" (2.8 cm) and ¾" (.95 cm) x 1" (2.5 cm)
- 14-26-S** FERGUSON Gall Stone Scoop 9½" (24.1 cm), double end, small size scoops ¾" (.95 cm) x 1" (2.5 cm) and 9/16" (.79 cm) x ¾" (1.9 cm)
- 14-27** MAYO Common Duct Scoop 10½" (26.7 cm), malleable shaft, small size, silver plated
- 14-28** MAYO Common Duct Scoop 10½" (26.7 cm), malleable shaft, medium size, silver plated
- 14-29** MAYO Common Duct Scoop 10½" (26.7 cm), malleable shaft, large size, silver plated

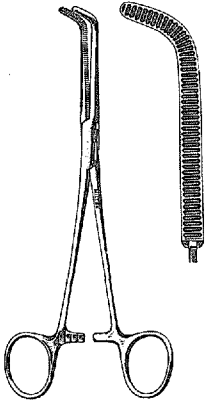

7-200
7-202

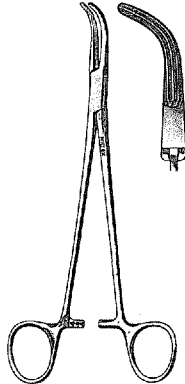

14-46

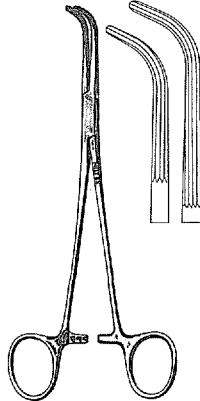

14-48
14-49

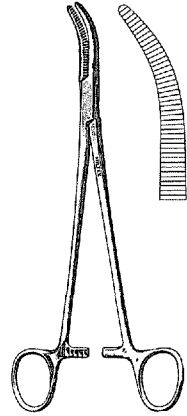

14-50

- 7-200 MIXTER Gall Duct Forceps 6 1/4" (15.9 cm)
- 7-202 MIXTER Gall Duct Forceps 7 1/4" (18.4 cm)
- 14-46 LOWER Gall Duct Forceps 7" (17.8 cm)
- 14-48 LAHEY Gall Duct Forceps 7 1/2" (19.1 cm)
- 14-49 LAHEY Gall Duct Forceps 9" (22.9 cm)
- 14-50 MOYNIHAN Gall Duct Forceps 8 1/2" (21.6 cm)
- 14-51 GREEN Cystic Duct Forceps 8 1/2" (21.6 cm), delicate

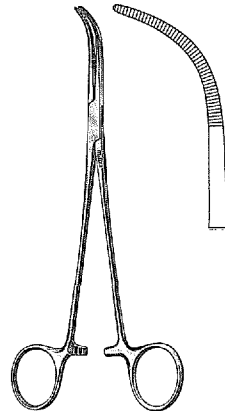

14-51

Gall Bladder Instruments

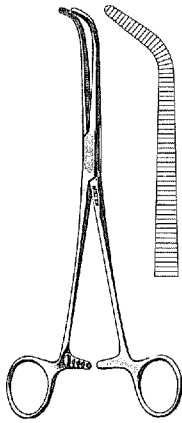

14-52

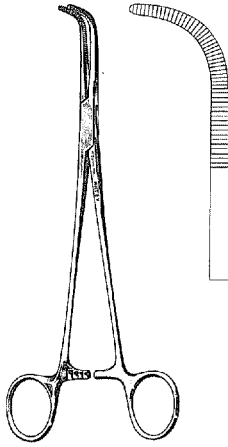

7-206

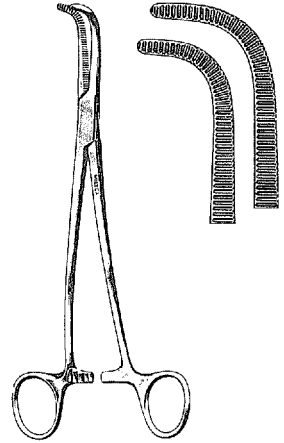

14-56

- 14-52 JOHNS HOPKINS Gall Bladder Forceps 8" (20.3 cm)
- 7-206 MIXTER Gall Bladder Forceps 9" (22.9 cm)
- 14-56 GRAY Cystic Duct Forceps 9" (22.9 cm), serrated, set of two

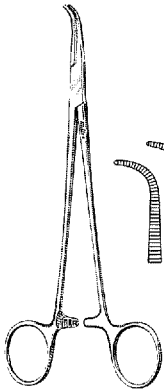

7-255 to 7-259

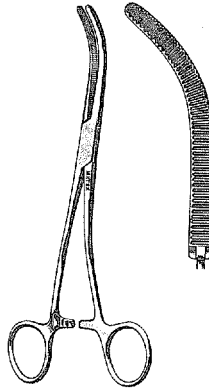

14-62

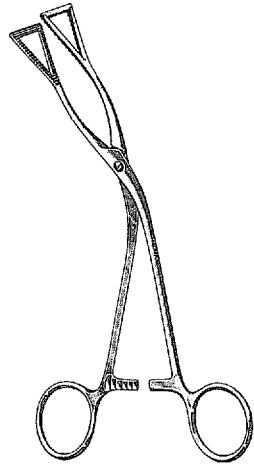

14-66

- 7-255 GEMINI-MIXTER Forceps 5½" (14 cm), delicate
- 7-256 GEMINI-MIXTER Forceps 7" (17.8 cm), delicate
- 7-257 GEMINI-MIXTER Forceps 8" (20.3 cm), delicate
- 7-258 GEMINI-MIXTER Forceps 9" (22.9 cm), delicate
- 7-259 GEMINI-MIXTER Forceps 11" (27.9 cm), delicate

- 14-62 SHALLCROSS Cystic Duct Forceps 7" (17.8 cm)
- 14-66 LOVELACE Gall Bladder Forceps 7¼" (18.4 cm), angular,
1" (2.5 cm) wide jaws

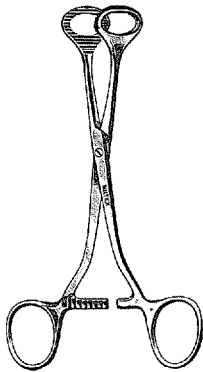

2-50

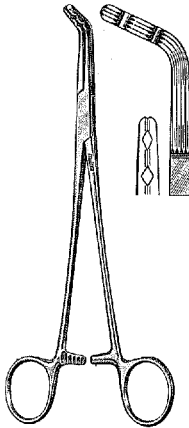

14-69

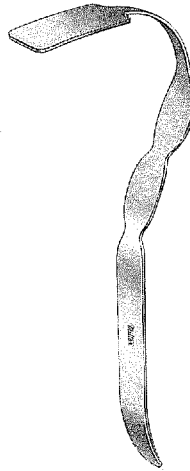

11-192

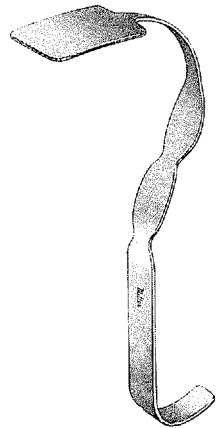

11-194

- 2-50** COLLIN (JUDD-DeMARTEL) Gall Bladder Forceps 6" (15.2 cm)
- 14-69** MALIK Cystic Duct Catheter Clamp for Cholangiography 8½" (21.6 cm), jaws are designed to hold different sizes of catheters.
- 11-192** JUNG Mini-Chole Retractor 10½" (26. cm), 3 cm width blade
- 11-194** JUNG Mini-Chole Retractor 9" (22.9 cm), 4 cm width blade
- 11-196** JUNG Mini-Chole Retractors, set of 2 each of 3 cm width blade and 1 each of 4 cm width blade

For a full line of Retractors see pages 151 - 187

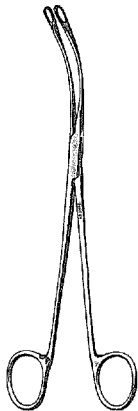

14-84
14-86

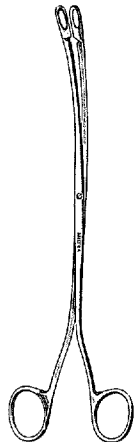

14-88

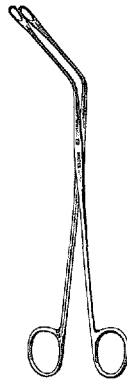

14-90

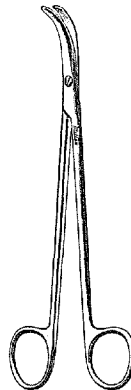

5-244
5-245

- 14-84 BLAKE Gall Stone Forceps 8½" (21.6 cm), straight
- 14-86 BLAKE Gall Stone Forceps 8½" (21.6 cm), curved
- 14-88 DESJARDIN (ROCHESTER) Gall Stone Forceps 9" (22.9 cm)
- 14-90 MIXTER Gall Stone Forceps 9" (22.9 cm), length from tip to angle 3" (7.6 cm)
- 5-244 THOREK Gall Bladder Scissors 7¼" (18.4 cm), full curve
- 5-245 THOREK Gall Bladder Scissors 10" (25.4 cm), full curve

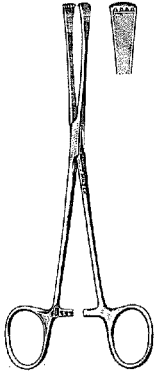

16-2

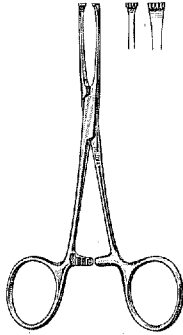

16-3
16-4

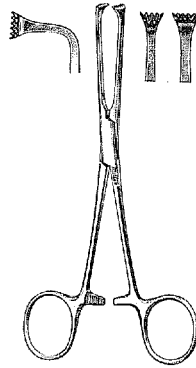

16-6 to 16-24

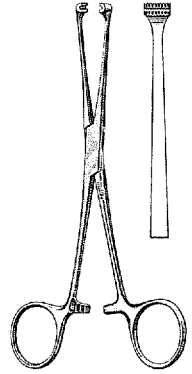

16-25
16-26

16-2 LOCKWOOD-ALLIS Tissue Forceps 6¼" (15.9 cm)

16-3 Baby ALLIS Tissue Forceps 5" (12.7 cm), 4 x 5 teeth, extra delicate jaws 2.5 mm wide

16-4 Baby ALLIS Tissue Forceps 5½" (14 cm), 4 x 5 teeth, delicate jaws 4 mm wide

16-6 ALLIS Tissue Forceps 6" (15.2 cm), 4 x 5 teeth

16-8 ALLIS Tissue Forceps 6" (15.2 cm), 5 x 6 teeth

16-10 ALLIS Tissue Forceps 7¼" (18.4 cm), 5 x 6 teeth

16-12 ALLIS Tissue Forceps 10" (25.4 cm), 5 x 6 teeth

16-20 ALLIS Tissue Forceps 6" (15.2 cm), 4 x 5 teeth, angular jaws

16-22 ALLIS Tissue Forceps 6" (15.2 cm), 5 x 6 teeth, angular jaws

16-24 ALLIS Tissue Forceps 7¼" (18.4 cm), 5 x 6 teeth, angular jaws

16-25 ALLIS-NC Tissue Forceps 6" (15.2 cm), with double row of non-traumatic teeth

16-26 ALLIS-NC Tissue Forceps 7¼" (18.4 cm), with double row of non-traumatic teeth

16-30 ALLIS-ADAIR Tissue Forceps 6½" (16.5 cm), 9 x 10 teeth

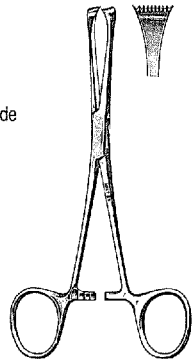

16-30



Intestinal Instruments

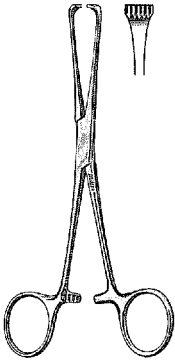

16-31

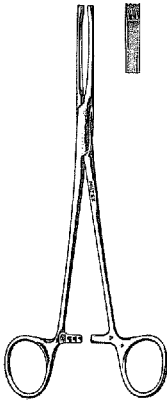

16-33
16-34

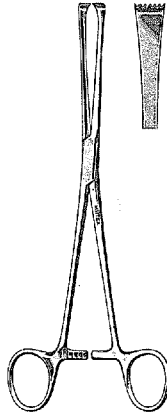

16-38

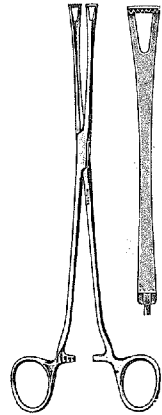

16-40

- 16-31 BOYS-ALLIS Tissue Forceps 6" (15.2 cm), 5 x 6 teeth, heavy pattern
- 16-33 JUDD-ALLIS Tissue Forceps 6" (15.2 cm), 3 x 4 teeth, delicate
- 16-34 JUDD-ALLIS Tissue Forceps 7½" (19.1 cm), 3 x 4 teeth, delicate
- 16-38 THOMS-ALLIS Tissue Forceps 8" (20.3 cm), 6 x 7 teeth
- 16-40 LOCKWOOD Tissue Forceps 7¾" (19.7 cm)
- 16-42 Baby BABCOCK Intestinal Forceps 5½" (14 cm), delicate jaws 6 mm wide
- 16-44 BABCOCK Intestinal Forceps 6¼" (15.9 cm), jaws 9 mm wide
- 16-46 BABCOCK Intestinal Forceps 8¼" (21 cm), jaws 10 mm wide
- 16-48 BABCOCK Intestinal Forceps 9½" (24.1 cm), jaws 15 mm wide

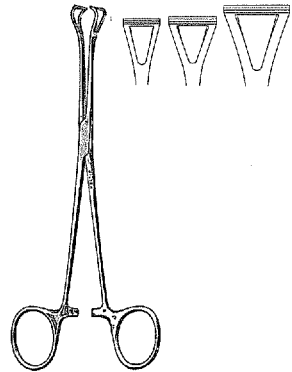

16-42 to 16-48

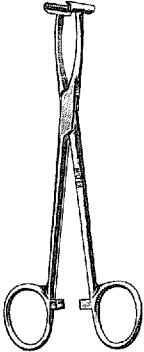

7-106

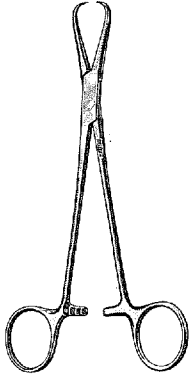

16-51

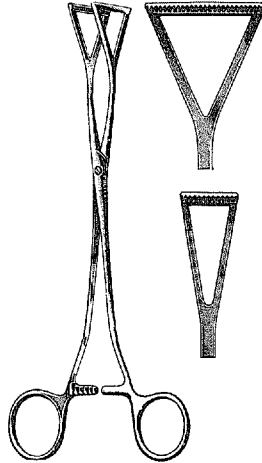

16-52
16-54

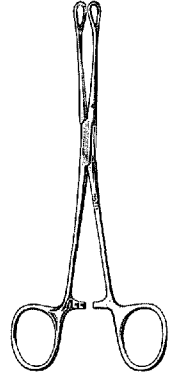

16-56

- 7-106 PRATT T-Clamp 6" (15.2 cm)
- 16-51 ADAIR Tissue Holding Tenaculum Forceps 6½" (16.5 cm)
- 16-52 COLLIN Intestinal Forceps 8" (20.3 cm), with ½" (1.3 cm) wide jaws
- 16-54 COLLIN Intestinal Forceps 8" (20.3 cm), with 1" (2.5 cm) wide jaws
- 16-56 WILLIAMS Intestinal Forceps 6½" (16.5 cm), cross serrated jaws
- 16-62 PERCY Intestinal Forceps 6" (15.2 cm), serrated jaws

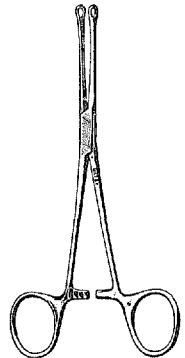

16-62

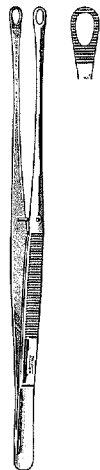

6-214

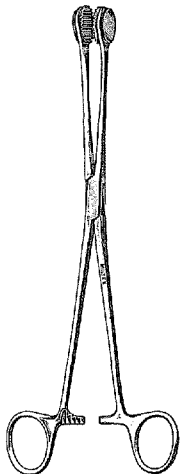

16-70

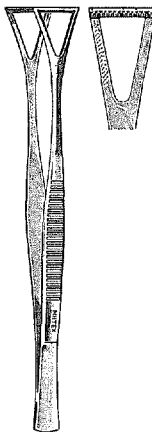

16-72



16-80

- 6-214 SINGLEY Tissue Forceps 9" (22.9 cm), with fenestrated serrated jaws
- 16-70 CHILD Intestinal Forceps 9¾" (24.8 cm), with interchangeable rubber jaws
- 2-62 Replacement Rubber Jaws for No. 16-70 forceps
- 16-72 COLLIN-DUVAL Tissue Forceps 8" (20.3 cm), with ½" (1.3 cm) wide jaws
- 16-80 WANGENSTEEN Tissue Forceps 9" (22.9 cm), rounded jaws with fine cross serrations
- 7-230 BAINBRIDGE Intestinal Forceps 6" (15.2 cm), straight, longitudinal serrations with cross tip serrations
- 7-232 BAINBRIDGE Intestinal Forceps 6" (15.2 cm), curved, longitudinal serrations with cross tip serrations
- 7-234 BAINBRIDGE Intestinal Forceps 7¼" (18.4 cm), straight, longitudinal serrations with cross tip serrations
- 7-236 BAINBRIDGE Intestinal Forceps 7¼" (18.4 cm), curved, longitudinal serrations with cross tip serrations

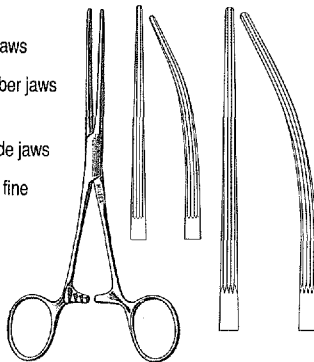

7-230 to 7-236

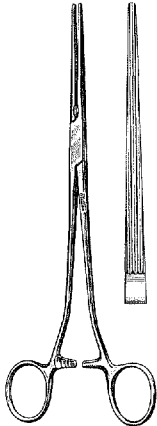

16-99

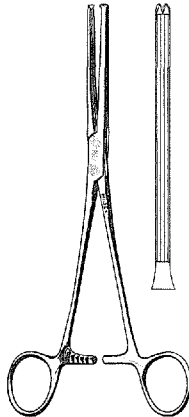

16-100

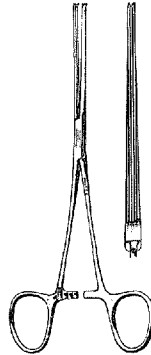

16-102

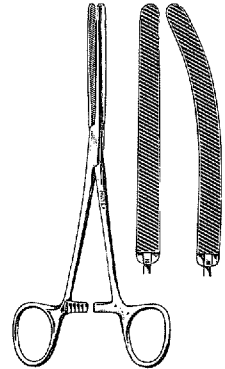

16-108
16-110

- 16-99 DENNIS Anastomosis Clamp 9" (22.9 cm), longitudinal serrations
- 16-100 ALLEN Intestinal Clamp 8" (20.3 cm), longitudinal serrations with 1 x 2 teeth
- 16-102 Baby ALLEN Intestinal Clamp 6½" (16.5 cm), delicate, longitudinal serrations with 1 x 2 teeth
- 16-108 Baby DOYEN Intestinal Forceps 6½" (16.5 cm), straight, flexible blades with diagonal serrations
- 16-110 Baby DOYEN Intestinal Forceps 6½" (16.5 cm), curved, flexible blades with diagonal serrations



Intestinal Instruments

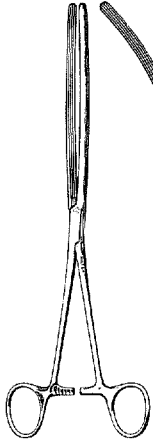

16-160
16-162

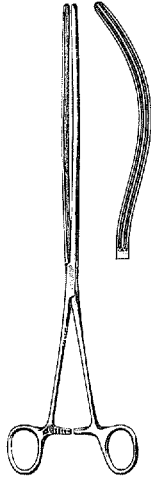

16-120
16-122

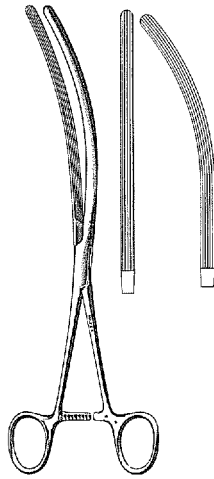

16-130
16-132

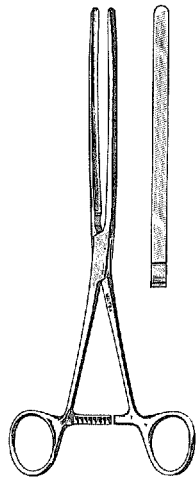

16-140

- 16-160 DOYEN Intestinal Forceps 9" (22.9 cm), straight, flexible blades with longitudinal serrations
- 16-162 DOYEN Intestinal Forceps 9" (22.9 cm), curved, flexible blades with longitudinal serrations
- 16-120 KOCHER Intestinal Forceps 10 1/2" (26.7 cm), straight, longitudinal serrations
- 16-122 KOCHER Intestinal Forceps 10 1/2" (26.7 cm), curved, longitudinal serrations
- 16-130 MAYO-ROBSON Intestinal Forceps 10" (25.4 cm), straight, longitudinal serrations
- 16-132 MAYO-ROBSON Intestinal Forceps 10" (25.4 cm), curved, longitudinal serrations
- 16-140 SCUDDER Intestinal Forceps 9 1/2" (24.1 cm), straight, smooth solid blades
- 30-1805 PEAN Intestinal Forceps 9" (22.9 cm), curved, with longitudinal serrations
- 30-1815 PEAN Intestinal Forceps 10 1/4" (26 cm), curved, with longitudinal serrations

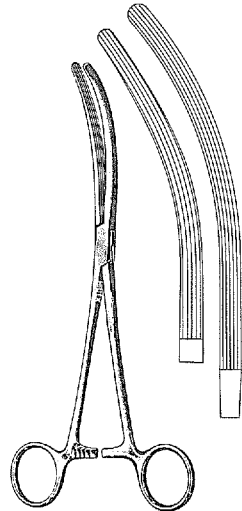

30-1805
30-1815

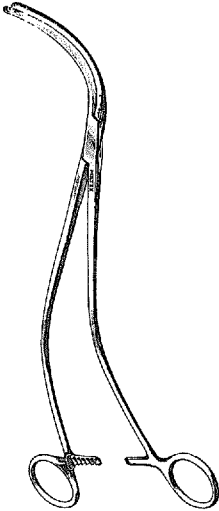

16-170

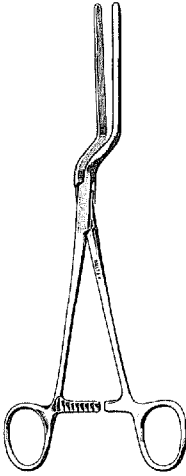

16-172

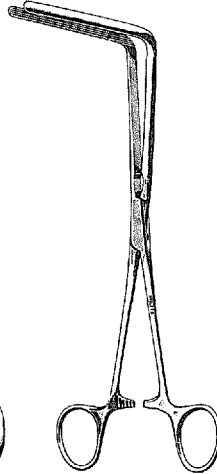

16-174

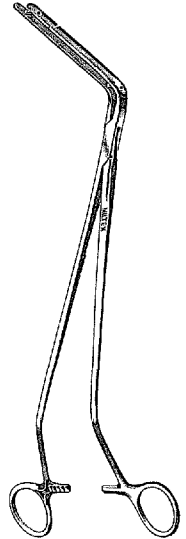

16-176

- 16-170 FOSS Anterior Resection Clamp 11½" (29.2 cm), S-shape with smooth jaws
- 16-172 BRUNNER Intestinal Forceps 9½" (24.1 cm), longitudinal serrations
- 16-174 FEHLAND Intestinal Clamp 9¾" (24.8 cm), right angle with ¾" (8.3 cm) long jaws
- 16-176 FOSS Intestinal Clamp 11¼" (29.8 cm), right angle with heavy jaws

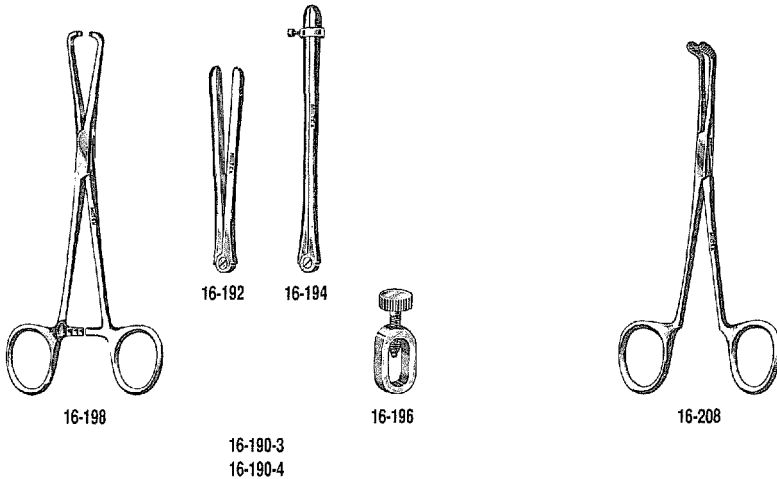

STONE INTESTINAL CLAMPS

- 16-190-3** STONE Clamp Set, including 2 applying forceps and 2 clamps 3" (7.6 cm) with locking devices
- 16-190-4** STONE Clamp Set, including 2 applying forceps and 2 clamps 4" (10.2 cm) with locking devices
- 16-192** STONE Intestinal Clamp 3" (7.6 cm) with locking device
- 16-194** STONE Intestinal Clamp 4" (10.2 cm) with locking device
- 16-196** Locking Device only for STONE Clamps
- 16-198** STONE Clamp Applying Forceps 6¼" (15.9 cm)
- 16-208** BENSON Pylorus Separator 5¾" (14.6 cm)

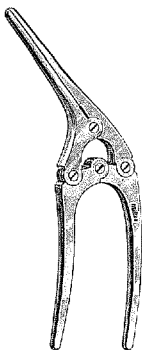

16-229

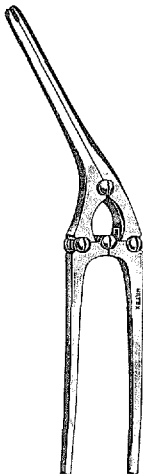

16-230 to 16-234

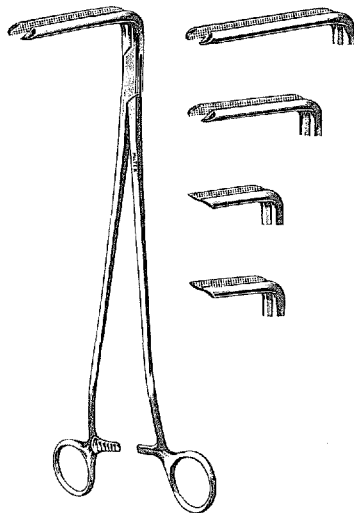

16-250 to 16-256

- 16-229 Baby PAYR Pylorus Clamp 6" (15.2 cm)
- 16-230 PAYR Pylorus Clamp 8" (20.3 cm)
- 16-232 PAYR Pylorus Clamp 11" (27.9 cm)
- 16-234 PAYR Pylorus Clamp 13¾" (34.9 cm)
- 16-250 BEST Colon Clamp Set of 4, including 1 clamp 7.5 cm, 1 clamp 6 cm and 2 clamps 3.5 cm
- 16-252 BEST Colon Clamp 10½" (26.7 cm), with 3.5 cm jaws
- 16-254 BEST Colon Clamp 10½" (26.7 cm), with 6 cm jaws
- 16-256 BEST Colon Clamp 10½" (26.7 cm), with 7.5 cm jaws



Micro Surgery Instruments

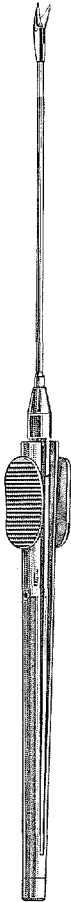

17-100
17-115
17-215



17-100



17-115
17-215



17-500

PENCIL-TYPE MICRO INSTRUMENTS

7/8" (18.4 cm) overall length; extremely delicate working ends

- 17-100 Forceps, 1 mm wide serrated jaws, straight shaft
- 17-115 Scissors, 4 mm long blades, straight shaft
- 17-215 Scissors, 4 mm long blades, angled shaft
- 17-500 MILTEX Micro Dissecting Scissors 5/8" (14.6 cm), double action, sharp points, spring handle

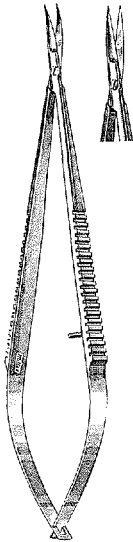

17-2060
17-2040

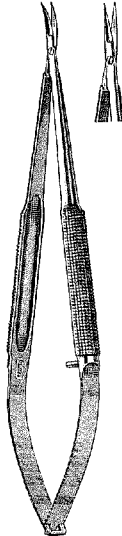

17-2150
17-2100

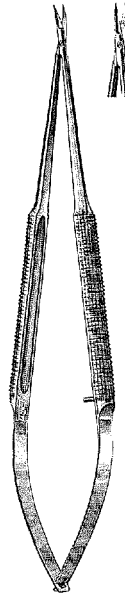

17-2160
17-2110

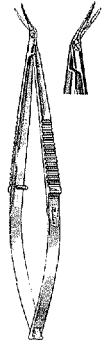

18-1558
18-1559

MILTEX MICRO SURGERY SCISSORS, sharp points

- | | |
|---------|--|
| 17-2060 | 6" (15.2 cm) straight, 8 mm blades, flat handles |
| 17-2040 | 6" (15.2 cm) curved, 8 mm blades, flat handles |
| 17-2150 | 6" (15.2 cm) straight, 6 mm blades, round handles |
| 17-2100 | 6" (15.2 cm) curved, 6 mm blades, round handles |
| 17-2160 | 7 $\frac{1}{8}$ " (18.1 cm) straight, 6 mm blades, round handles |
| 17-2110 | 7 $\frac{1}{8}$ " (18.1 cm) curved, 6 mm blades, round handles |
| 18-1558 | CASTROVIEJO Corneal Scissors 4" (10.2 cm), right, sub-miniature for micro surgery, 6 mm blades |
| 18-1559 | CASTROVIEJO Corneal Scissors 4" (10.2 cm), left, sub-miniature for micro surgery, 6 mm blades |

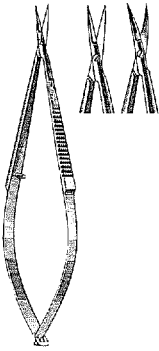

18-1618
18-1619

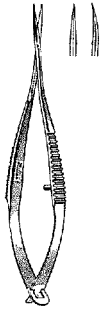

18-1625
18-1626

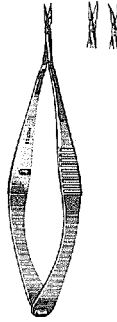

18-1630
18-1631

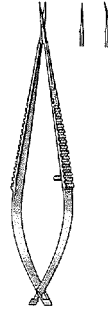

18-1633
18-1634

- 18-1618** Micro Iris Scissors 4" (10.2 cm), straight, sharp points
- 18-1619** Micro Iris Scissors 4" (10.2 cm), curved, sharp points
- 18-1625** McPHERSON-VANNAS Micro Iris Scissors 3/4" (8.3 cm), straight, sharp points
- 18-1626** McPHERSON-VANNAS Micro Iris Scissors 3/4" (8.3 cm), curved, sharp points
- 18-1630** Micro-VANNAS Scissors 3/4" (8.3 cm), straight, ultrafine blades
- 18-1631** Micro-VANNAS Scissors 3/4" (8.3 cm), curved, ultrafine blades
- 18-1633** Micro Scissors 3/4" (8.3 cm), straight, superfine blades
- 18-1634** Micro Scissors 3/4" (8.3 cm), curved, superfine blades
- 19-2150-B** BELLUCCI Micro Ear Scissors 2 3/4" (7 cm) shaft, 4 mm blades, ebony finish

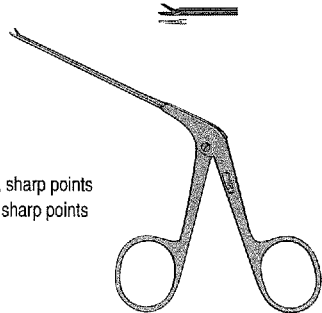

19-2150-B



17-301



17-302



17-303



17-303C

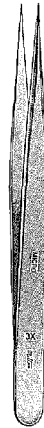

17-303X



17-304

SWISS JEWELER STYLE FORCEPS Non-Magnetic Stainless Steel

- 17-301 Style 1, fine $4\frac{3}{4}$ " (12.1 cm)
- 17-302 Style 2, strong, fine, $4\frac{3}{4}$ " (12.1 cm)
- 17-303 Style 3, narrow, fine, $4\frac{3}{4}$ " (12.1 cm)
- 17-303C Style 3C, narrow, fine, $4\frac{3}{8}$ " (11.2 cm)
- 17-303X Style 3, micro-fine, $4\frac{3}{4}$ " (12.1 cm)
- 17-304 Style 4, fine, $4\frac{3}{8}$ " (11.2 cm)
- 17-305 Style 5, super fine, $4\frac{3}{8}$ " (11.2 cm)

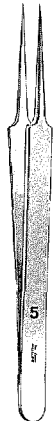

17-305

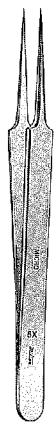

17-305X



17-306



17-307



17-307X

SWISS JEWELER STYLE FORCEPS Non-Magnetic Stainless Steel

- 17-305X Style 5, micro-fine, $4\frac{3}{8}''$ (11.2 cm)
- 17-306 Style 6, pickup, $4\frac{1}{2}''$ (11.4 cm)
- 17-307 Style 7, fine curved, $4\frac{1}{2}''$ (11.4 cm)
- 17-307X Style 7, micro-fine, curved, $4\frac{1}{2}''$ (11.4 cm)
- 17-1100 RHOTON Micro Suture Forceps $7''$ (17.8 cm), straight, with 0.7 mm tying platform
- 17-1150 RHOTON Micro Forceps $7''$ (17.8 cm), straight, 0.3 mm tips

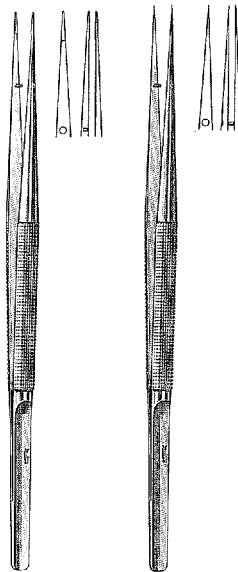

17-1100

17-1150



17-2500



17-2510

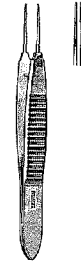

18-835

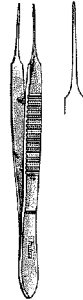

18-836



18-837
18-838



18-948
18-949

- 17-2500** Micro ADSON Tissue Forceps 4 $\frac{3}{4}$ " (12.1 cm), jaws 0.5 mm wide, 1 x 2 teeth
- 17-2510** Micro ADSON Dressing Forceps 4 $\frac{3}{4}$ " (12.1 cm), serrated jaws 0.5 mm wide
- 18-835** BONN Micro Suturing Forceps 2 $\frac{3}{4}$ " (7 cm), 1 x 2 teeth 0.12 mm, with tying platform
- 18-836** BONN Micro Suturing Forceps 3 $\frac{3}{4}$ " (9.5 cm), 1 x 2 teeth 0.12 mm, with tying platform
- 18-837** McPHERSON Micro Suturing Forceps 3 $\frac{1}{2}$ " (8.9 cm), straight, 1 x 2 teeth 0.2 mm, with tying platform
- 18-838** McPHERSON Micro Suturing Forceps 3 $\frac{1}{2}$ " (8.9 cm), angled, 1 x 2 teeth 0.2 mm, with tying platform
- 18-948** McPHERSON Micro Iris Suturing Forceps 3 $\frac{1}{2}$ " (8.9 cm), straight, smooth platform 0.3 x 5 mm, no teeth
- 18-949** McPHERSON Micro Iris Suturing Forceps 3 $\frac{1}{2}$ " (8.9 cm), angled, smooth platform 0.3 x 5 mm, no teeth



Micro Surgery Instruments



18-867



18-953

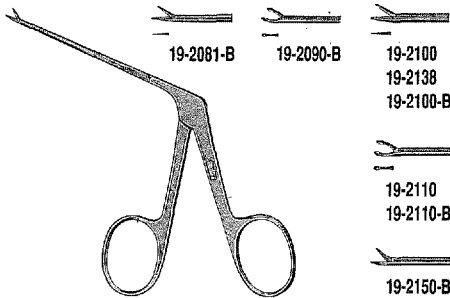

19-2081-B to 19-2150-B

19-2081-B

19-2090-B

19-2100

19-2138

19-2100-B

19-2110

19-2110-B

19-2150-B

- 18-867** BISHOP-HARMON Micro Tissue Forceps $3\frac{3}{8}$ " (8.6 cm), delicate 0.3 mm 1 x 2 teeth
- 18-953** CASTROVIEJO Micro Suturing Forceps 4" (10.2 cm), with 11 mm wide handles, 1 x 2 teeth 0.12 mm, with tying platform
- 19-2081-B** Micro Alligator Ear Forceps $3\frac{1}{4}$ " (8.3 cm) shaft, serrated jaws 0.6 mm wide, ebony finish
- 19-2100** Micro Alligator Ear Forceps $3\frac{1}{4}$ " (8.3 cm) shaft, serrated jaws 0.8 mm wide
- 19-2100-B** Micro Alligator Ear Forceps $3\frac{1}{4}$ " (8.3 cm) shaft, serrated jaws 0.8 mm wide, ebony finish
- 19-2090-B** Micro Alligator Ear Forceps $3\frac{1}{4}$ " (8.3 cm) shaft, oval cup jaws 0.5 mm wide, ebony finish
- 19-2110** Micro Alligator Ear Forceps $3\frac{1}{4}$ " (8.3 cm) shaft, oval cup jaws 0.8 mm wide
- 19-2110-B** Micro Alligator Ear Forceps $3\frac{1}{4}$ " (8.3 cm) shaft, oval cup jaws 0.8 mm wide, ebony finish
- 19-2138** HOUSE Micro Strut Forceps $2\frac{3}{4}$ " (7 cm) shaft, smooth jaws 0.8 mm wide
- 19-2150-B** BELLUCCI Micro Ear Scissors, $2\frac{3}{4}$ " (7 cm) shaft, 4 mm blades, ebony finish

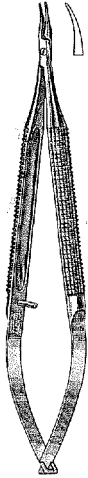

17-1000

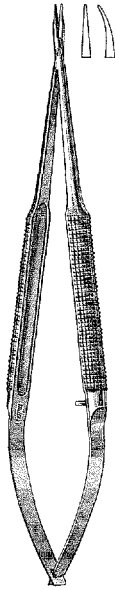

17-980
17-1010

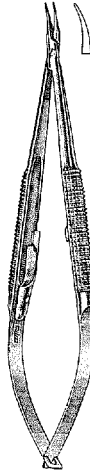

17-1020

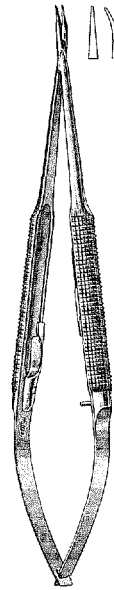

17-1024
17-1025

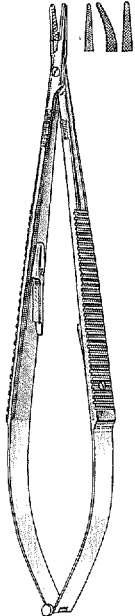

17-1090TC
to 17-1092TC

MILTEX MICRO SURGERY NEEDLE HOLDERS with round handle, 0.6 mm tips

- 17-1000 5¼" (13.3 cm) curved jaws
- 17-980 7½" (18.1 cm) straight jaws
- 17-1010 7½" (18.1 cm) curved jaws
- 17-1020 5¼" (13.3 cm) curved jaws, with lock
- 17-1024 7½" (18.1 cm) straight jaws, with lock
- 17-1025 7½" (18.1 cm) curved jaws, with lock
- 17-1090TC JACOBSON Microvascular Needle Holder 7" (17.8 cm), straight, with lock, with CARB-N-SERT jaws
- 17-1091TC JACOBSON Microvascular Needle Holder 7" (17.8 cm), curved, with lock, with CARB-N-SERT jaws
- 17-1092TC JACOBSON Microvascular Needle Holder 8½" (21.6 cm), straight, with lock, with CARB-N-SERT jaws



Micro Surgery Instruments

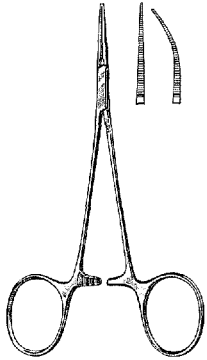

17-2600
17-2602

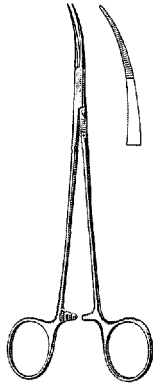

17-2603



17-4000



17-4005



17-4010



17-4015



17-4050



17-4060



17-4070

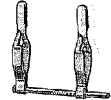

17-4030

- 17-2600 JACOBSON Micro Mosquito Forceps 5" (12.7 cm), straight, extremely delicate
- 17-2602 JACOBSON Micro Mosquito Forceps 5" (12.7 cm), curved, extremely delicate
- 17-2603 JACOBSON Hemostatic Forceps 7" (17.8 cm), curved, extremely delicate

MICRO VESSEL CLIPS

- 17-4000 straight 0.75 x 4 mm jaws
- 17-4005 straight 0.8 x 6 mm jaws
- 17-4010 straight 1 x 8 mm jaws
- 17-4015 straight 1.5 x 10 mm jaws
- 17-4050 slightly curved 1 x 6 mm jaws
- 17-4060 fully curved 1 x 6 mm jaws
- 17-4070 45° angle 1 x 6 mm jaws
- 17-4030 Micro Clip Approximator Set, 2 x 6 mm jaws, 15 mm spread
- 17-4100 Applying Forceps for Micro Clips 5 3/4" (14.6 cm), with lock
- 17-4102 Applying Forceps for Micro Clips 5 1/2" (14 cm)



17-4100



17-4102



7-310



7-315

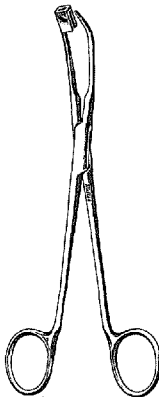

26-1040



26-1041



26-1042



26-1043

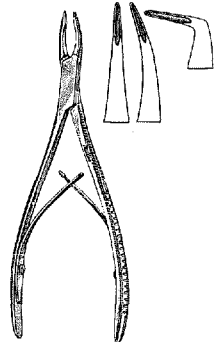

17-4800
17-4801
17D-4802

- 7-310** DIETHRICH Micro Bulldog Clamp 1 7/8" (4.7 cm), straight jaws 8 mm x 1.2 mm
- 7-315** DIETHRICH Micro Bulldog Clamp 1 3/4" (4.4 cm), angled jaws 8 mm x 1.2 mm
- 26-1040** SCHWARTZ Clip Applying Forceps 8" (20.3 cm)
- 26-1041** SCHWARTZ Vessel Clip 1" (2.5 cm), straight, jaws 1.7 x 8 mm
- 26-1042** SCHWARTZ Vessel Clip 1" (2.5 cm), slightly angled, jaws 1.7 x 8 mm
- 26-1043** SCHWARTZ Vessel Clip 1" (2.5 cm), strong angle, jaws 1.7 x 8 mm
- 17-4800** Micro FRIEDMAN Rongeur 5 1/2" (14 cm), straight 1.3 mm wide jaws, very delicate
- 17-4801** Micro FRIEDMAN Rongeur 5 1/2" (14 cm), curved 1.3 mm wide jaws, very delicate
- 17D-4802** Micro FRIEDMAN Rongeur 5 1/2" (14 cm), 90° angled 1.3 mm wide jaws, very delicate

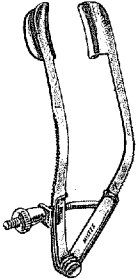

18-2

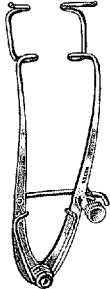

18-4



18-10 to 18-14



18-20

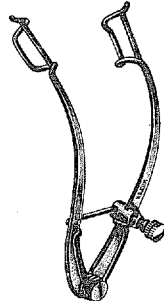

18-22
18-24

- 18-2 LANCASTER Eye Speculum $3\frac{1}{4}$ " (8.3 cm), blades 15 x 5 mm
- 18-4 KNAPP Eye Speculum $3\frac{1}{4}$ " (8.3 cm), blades 15 x 6 mm
- 18-10 CASTROVIEJO Eye Speculum 4" (10.2 cm), large blades 18 x 5 mm O.D.
- 18-12 CASTROVIEJO Eye Speculum $3\frac{3}{4}$ " (9.5 cm), medium blades 15 x 5 mm O.D.
- 18-14 CASTROVIEJO Eye Speculum $3\frac{3}{4}$ " (9.5 cm), small blades 13 x 5 mm O.D.
- 18-20 LANGE Eye Speculum $3\frac{5}{8}$ " (9.2 cm), blades 20 x 5 mm
- 18-22 WILLIAMS Eye Speculum $3\frac{1}{4}$ " (8.3 cm), large blades 15 x 5 mm
- 18-24 WILLIAMS Eye Speculum $2\frac{3}{4}$ " (7 cm), small blades 11 x 5 mm

NOTE: All above instruments are Non-Magnetic

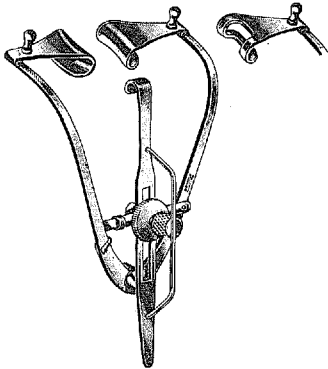

18-30
18-32

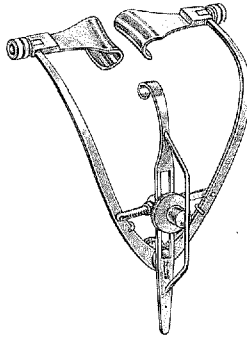

18-33

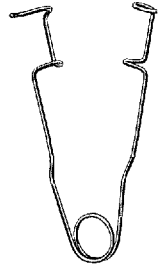

18-34

- 18-30 GUYTON-PARK Eye Speculum 3½" (8.9 cm), solid blades 14 mm wide, with suture posts
- 18-32 GUYTON-PARK Eye Speculum 3½" (8.9 cm), fenestrated blades 14 mm wide, with suture posts
- 18-33 MAUMENEE-PARK Eye Speculum 3½" (8.9 cm), solid blades 14 mm wide, with lock screws
- 18-34 Plain Wire Eye Speculum 2½" (6.4 cm), blades 15 mm wide

NOTE: All above instruments are Non-Magnetic

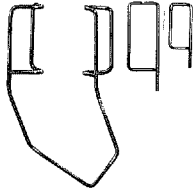

18-35
18-36



18-46



18-47

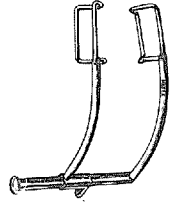

18-50

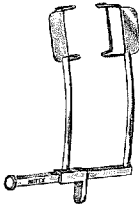

18-54

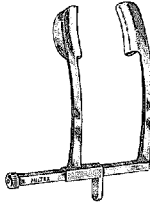

18-62

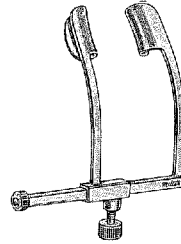

18-63
18-64

- 18-35 BARRAQUER Eye Speculum 1 3/4" (4.4 cm), large blades 15 mm wide
- 18-36 BARRAQUER Eye Speculum 1 3/4" (4.4 cm), small blades 10 mm wide
- 18-46 SMITH Eye Speculum 3" (7.6 cm), blades 15 mm wide, with concealed spring, chrome
- 18-47 SAUER Eye Speculum 1 1/4" (3.2 cm), infant size, 10 mm blades
- 18-50 MURDOCK Eye Speculum 2 1/4" (5.7 cm), blades 15 mm wide, chrome
- 18-54 WIENER Eye Speculum 2 1/4" (5.7 cm), blades 15 mm, with extensions to cover eye lashes, chrome
- 18-62 MCKINNEY Eye Speculum 2 1/2" (5.4 cm), blades 15 mm wide, chrome
- 18-63 COOK Eye Speculum 1 7/8" (4.7 cm), infant size, 9 mm blades
- 18-64 COOK Eye Speculum 1 7/8" (4.7 cm), child size, 11 mm blades

NOTE: All above instruments are Non-Magnetic

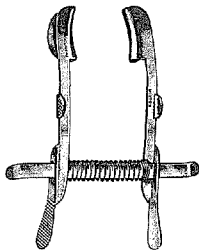

18-66



18-68



18-80



18-84

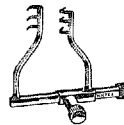

18-88

- 18-66 MELLINGER Eye Speculum 2¾" (7 cm), solid blades 15 mm wide
- 18-68 MELLINGER Eye Speculum 2¾" (7 cm), fenestrated blades 15 mm wide
- 18-80 AGRICOLA Lacrimal Sac Retractor 1½" (3.8 cm), 3 x 3 pointed prongs 4 mm deep
- 18-84 MELLER Lacrimal Sac Retractor 2⅞" (7.3 cm), 3 x 3 prongs 3 mm deep
- 18-88 GOLDSTEIN Lacrimal Sac Retractor 1½" (2.8 cm), 3 x 3 pointed prongs 5 mm deep
- 18-96 STEVENSON Lacrimal Sac Retractor 3¼" (8.3 cm), 3 x 3 prongs 3 mm deep

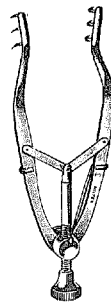

18-96

NOTE: All above instruments are Non-Magnetic



18-100
18-102



11D-27

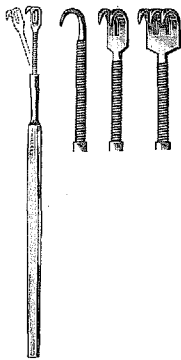

11-30 to 11-34

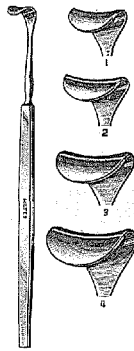

18-110 to 18-116



18-120

- 18-100 KNAPP (ROLLET) Retractor 5¼" (13.3 cm), with 4 sharp prongs
- 18-102 KNAPP Retractor 5¼" (13.3 cm), with 4 blunt prongs
- 11D-27 KNAPP Lacrimal Sac Retractor 5" (12.7 cm), flexible shaft, 3 sharp prongs
- 11-30 KNAPP Lacrimal Sac Retractor 6" (15.2 cm), flexible shaft, 1 sharp prong
- 11-32 KNAPP Lacrimal Sac Retractor 6" (15.2 cm), flexible shaft, 2 sharp prongs
- 11-34 KNAPP Lacrimal Sac Retractor 6" (15.2 cm), flexible shaft, 3 sharp prongs
- 18-110 DESMARRES Lid Retractor 5½" (14 cm), size 1, 11 mm
- 18-112 DESMARRES Lid Retractor 5½" (14 cm), size 2, 13 mm
- 18-114 DESMARRES Lid Retractor 5½" (14 cm), size 3, 15 mm
- 18-116 DESMARRES Lid Retractor 5½" (14 cm), size 4, 17 mm
- 18-120 JAEGER Lid Plate 4" (10.2 cm), blades 20 mm and 23 mm

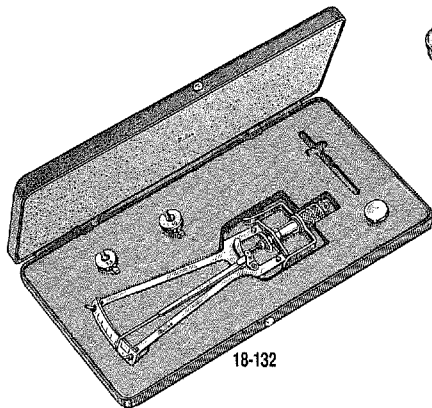

18-132

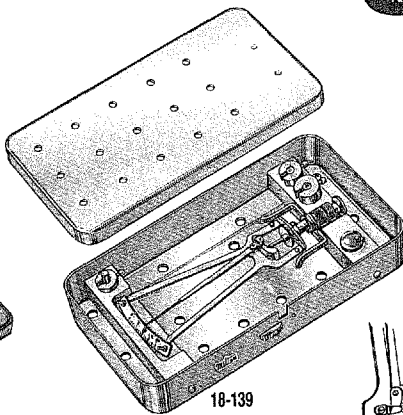

18-139

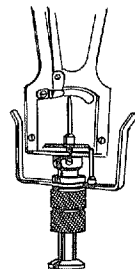

18-132A
18-134A

SCHIOTZ TONOMETERS

All units are constructed with jewelled hammers to minimize friction. Auto-clavable. Scale markings are etched for accuracy. Scales are inclined, permitting reading from above.

Each unit supplied with certification to meet specification established by the Committee on Standardization of Tonometers of the A.A.O.D. Individually packaged in fitted case with weights and test block.

- 18-132** Original Model, with 3 weights (5.5 gr., 7.5 gr. and 10 gr.) Plunger, Footplate and Test Block are stainless steel; remainder made of rustless materials
- 18-132A** Same as No. 18-132, but with Allen Plunger Retractor*
- 18-134** Improved Model, with 4 weights (5.5 gr., 7.5 gr., 10 gr. and 15 gr.), mirror insert on scale reduces error of parallax; entirely made of stainless steel.
- 18-134A** Same as No. 134, but with Allen Plunger Retractor*
- 18-139** Sterilizing Case for Schiotz Tonometers 6½" (16.5 cm) x 3½" (8.9 cm) x 1¼" (3.2 cm) fitted to firmly hold tonometer, weights and test block

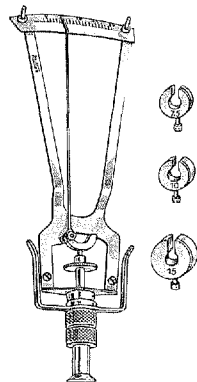

18-134

*With the Allen Plunger Retractor, the plunger is held in retracted position, flush with the surface of the footplate until tonometer is in place on cornea. This feature will prevent any possible damage to cornea tissue.

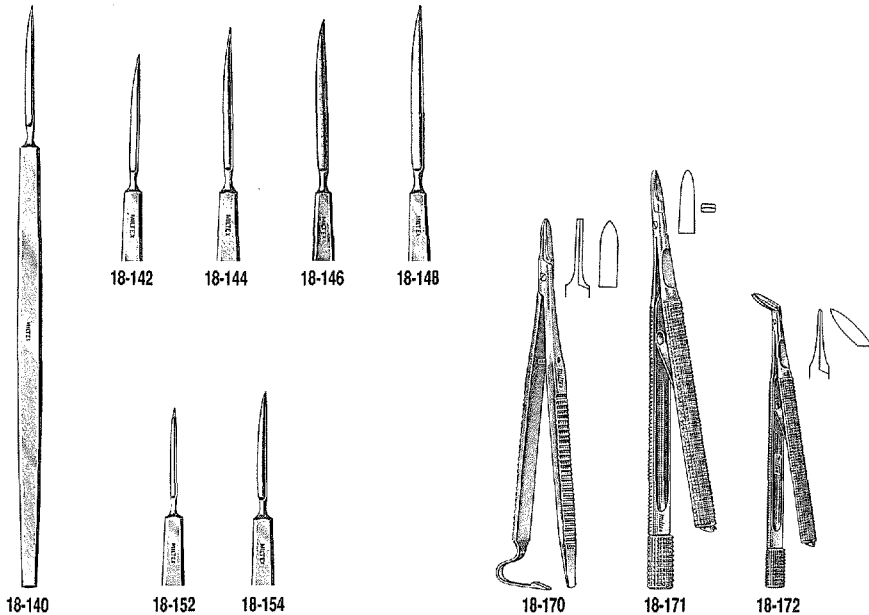

- 18-140** VON GRAEFE Cataract Knife No. 1, 1.5 x 25 mm
- 18-142** VON GRAEFE Cataract Knife No. 2, 1.7 x 27 mm
- 18-144** VON GRAEFE Cataract Knife No. 3, 2 x 30 mm
- 18-146** VON GRAEFE Cataract Knife No. 4, 2.3 x 33 mm
- 18-148** VON GRAEFE Cataract Knife No. 5, 2.5 x 35 mm
- 18-152** WHEELER Discission Knife 1 x 18 mm
- 18-154** KNAPP Cataract Knife 1 x 20 mm
- 18-170** BARRAQUER Blade Breaker and Holder 4½" (11.4 cm), with ratchet lock
- 18-171** CASTROVIEJO Blade Breaker and Holder 5¼" (13.3 cm), with push-pull lock
- 18-172** TROUTMAN-BARRAQUER Mini Blade Breaker and Holder 3¾" (9.5 cm), angled jaws 3 x 10 mm, with push-pull lock



18-259 to 18-264



18-270



18-292



18-302



18-304



18-308



18-314



18-320

- 18-259 ZIEGLER Knife-Needle 4½" (11.4 cm), size 0, 3 mm blade
- 18-260 ZIEGLER Knife-Needle 4½" (11.4 cm), size 1, 5 mm blade
- 18-262 ZIEGLER Knife-Needle 4½" (11.4 cm), size 2, 6 mm blade
- 18-264 ZIEGLER Knife-Needle 4½" (11.4 cm), size 3, 7 mm blade

18-270 KNAPP Knife-Needle 4½" (11.4 cm), 5 mm blade

18-292 DEAN Knife-Needle 5" (12.7 cm), curved blade 1 x 7 mm

18-302 WALTER Corneal Spud 4¾" (11.8 cm), straight blade 4 mm

18-304 WALTER Corneal Spud 4¾" (11.8 cm), curved blade 4 mm

18-308 BOWMAN Needle with stop 4¾" (12.1 cm), straight blade 3 mm

18-314 VON GRAEFE (BECKER) Cystotome 4¾" (12.1 cm), 1 mm blade, right angle, malleable shaft

18-320 WILDER Cystotome 5" (12.7 cm), angled blade 3 mm edge

18-330 GILL Corneal Knife 4¾" (12.1 cm), slightly curved 3.5 mm wide blade

18-331 DESMARRES Corneal Dissector 4¾" (12.1 cm), 3 x 8 mm blade

18-344 BARKAN Goniotomy Knife 4½" (11.4 cm), 2.5 mm blade

18-350 TOOKE Corneal Knife 4½" (11.4 cm), 2.5 x 15 mm dissecting blade

18-370 Foreign Body Needle 5" (12.7 cm), 2 x 5 mm blade



18-330



18-331



18-344



18-350



18-370



18-372



18-374



18-376



18-380



18-384

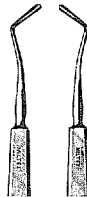

18-388
18-390

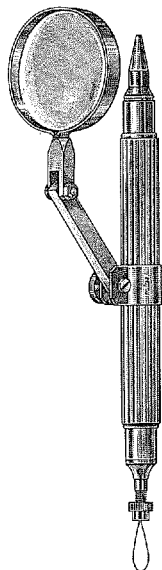

18-398M



18-398

- 18-372 DAVIS Foreign Body Spud 4 $\frac{3}{4}$ " (12.1 cm), 0.8 mm blade
- 18-374 DIX Foreign Body Spud 4 $\frac{3}{4}$ " (12.1 cm), 1.7 x 15 mm blade
- 18-376 WALTON Foreign Body Gauge 4 $\frac{1}{2}$ " (11.4 cm), round end
- 18-380 ELLIS Foreign Body Spud 4 $\frac{1}{2}$ " (11.4 cm), 1.2 mm blade, curved
- 18-384 ALVIS Foreign Body Spud 4 $\frac{3}{4}$ " (12.1 cm), oval curette 1 x 3 mm with fine point
- 18-388 HOSFORD Foreign Body Spud 4 $\frac{3}{4}$ " (12.1 cm), gouge blade 1 x 7 mm rounded tip, angled to right
- 18-390 HOSFORD Foreign Body Spud 4 $\frac{3}{4}$ " (12.1 cm), gouge blade 1 x 7 mm rounded tip, angled to left
- 18-398 Eye Magnet and Foreign Body Loop. The magnet probe and the Perlon loop are reversible in the pencil-shape handle. In plastic case.
- 18-398M Eye Magnet and Foreign Body Loop with adjustable Magnifier attached. Reversible plastic handle, metal parts are plated, in plastic case.
- 18-399 MILTEX Eye Magnet; a powerful magnetic cylinder with one round and one pointed interchangeable tip. In velvet lined steel case.

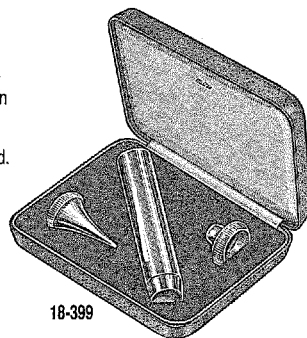

18-399

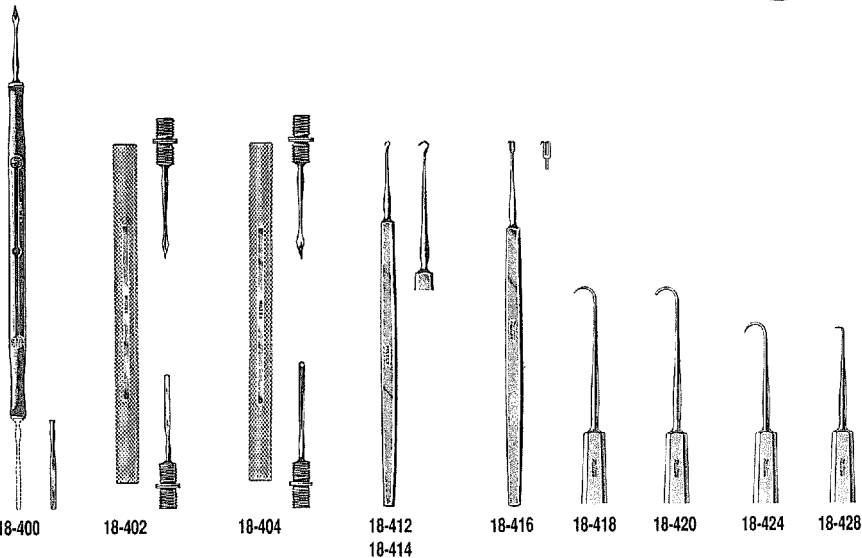

- 18-400** DIX Foreign Body Needle and Spud, protected in sliding handle
- 18-402** DIX Foreign Body Needle and Spud, protected in reversible screw handle
- 18-402A** DIX Foreign Body Needle with screw socket
- 18-402B** DIX Foreign Body Spud with screw socket
- 18-404** DIX Foreign Body Needle and Gouge, protected in reversible screw handle
- 18-412** TYRELL Hook 5" (12.7 cm), sharp
- 18-414** TYRELL Hook 5" (12.7 cm), blunt
- 18-416** GUTHRIE Fixation Hook 5" (12.7 cm), sharp double prongs 1.5 mm wide
- 18-418** WIENER Corneal Hook 5" (12.7 cm), sharp
- 18-420** WIENER Corneal Hook 5" (12.7 cm), blunt
- 18-424** O'CONNOR Hook 4¾" (12.1 cm), sharp
- 18-428** NUGENT Hook 4¾" (12.1 cm), right angle, sharp
- 21-152** MILTEX Hook 4¾" (12.1 cm), sharp prong 2 mm diameter
- 33-121** SELTZER Hook 4½" (11.4 cm), sharp point

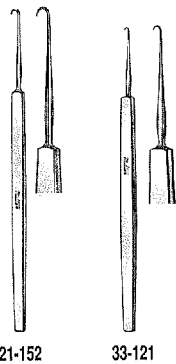



18-439



18-440



18-442



18-446

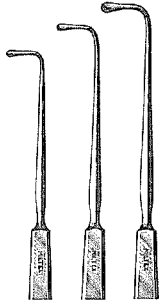

18-450 to 18-454



18-472



18-480
18-482



18-484
18-486

- 18-439** McGANNON Retractor 5" (12.7 cm), fenestrated blade 2.5 mm wide
- 18-440** STEVENS Tenotomy Hook 5" (12.7 cm), right angle 5 mm deep
- 18-442** GREEN Strabismus Hook 5" (12.7 cm), 9 mm deep
- 18-446** JAMESON Strabismus Hook 5" (12.7 cm), 10 mm deep
- 18-450** VON GRAEFE Strabismus Hook 5½" (14 cm), small size 8 mm long
- 18-452** VON GRAEFE Strabismus Hook 5½" (14 cm), medium size 10 mm long
- 18-454** VON GRAEFE Strabismus Hook 5½" (14 cm), large size 11 mm long
- 18-472** DAVIEL Lens Spoon 5" (12.7 cm), 3 mm wide
- 18-480** LEWIS Lens Loop 5¼" (13.3 cm), serrated loop 5.5 x 8 mm
- 18-482** LEWIS Lens Loop 5¼" (13.3 cm), smooth loop 5.5 x 8 mm
- 18-484** WILDER Lens Loop 5¼" (13.3 cm), serrated loop 4 x 15 mm
- 18-486** WILDER Lens Loop 5¼" (13.3 cm), smooth loop 4 x 15 mm

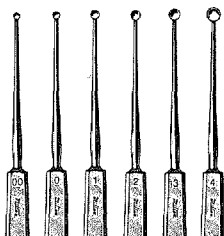

18-498 to 18-506

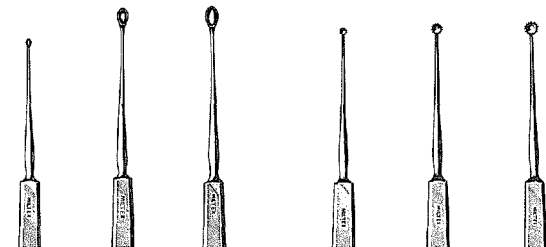

18-510

18-512

18-514

18-520

18-522

18-524

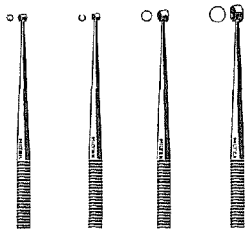

18-530 to 18-536

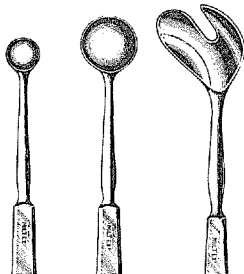

18-540

18-542

18-550

- 18-498 MEYHOEFER Chalazion Curette 5" (12.7 cm), size 00, 1 mm
- 18-499 MEYHOEFER Chalazion Curette 5" (12.7 cm), size 0, 1.5 mm
- 18-500 MEYHOEFER Chalazion Curette 5" (12.7 cm), size 1, 1.7 mm
- 18-502 MEYHOEFER Chalazion Curette 5" (12.7 cm), size 2, 2 mm
- 18-504 MEYHOEFER Chalazion Curette 5" (12.7 cm), size 3, 2.5 mm
- 18-506 MEYHOEFER Chalazion Curette 5" (12.7 cm), size 4, 3.5 mm

- 18-510 HEBRA Chalazion Curette 5" (12.7 cm), oval cup 1 x 1.7 mm
- 18-512 HEBRA Chalazion Curette 5" (12.7 cm), oval cup 2 x 3.3 mm
- 18-514 HEBRA Chalazion Curette 5" (12.7 cm), oval cup 2.5 x 4 mm

18-520 SKEELE Chalazion Curette 5" (12.7 cm), round cup 1 mm, serated edge

18-522 SKEELE Chalazion Curette 5" (12.7 cm), round cup 2 mm, serated edge

18-524 SKEELE Chalazion Curette 5" (12.7 cm), round cup 2.5 mm, serated edge

18-530 HEATH Chalazion Curette 4" (10.2 cm), size 0, one sharp and one blunt edge, 1/2 mm

18-532 HEATH Chalazion Curette 4" (10.2 cm), size 1, one sharp and one blunt edge, 1 mm)

18-534 HEATH Chalazion Curette 4" (10.2 cm), size 2, one sharp and one blunt edge, 2 mm

18-536 HEATH Chalazion Curette 4" (10.2 cm), size 3, one sharp and one blunt edge, 3 mm

18-540 BUNGE Evisceration Spoon 5 1/2" (14 cm), small size 8 mm cup

18-542 BUNGE Evisceration Spoon 5 1/2" (14 cm), large size 11 mm cup

18-550 WELLS Enucleation Spoon 6" (15.2 cm), cup 21 mm

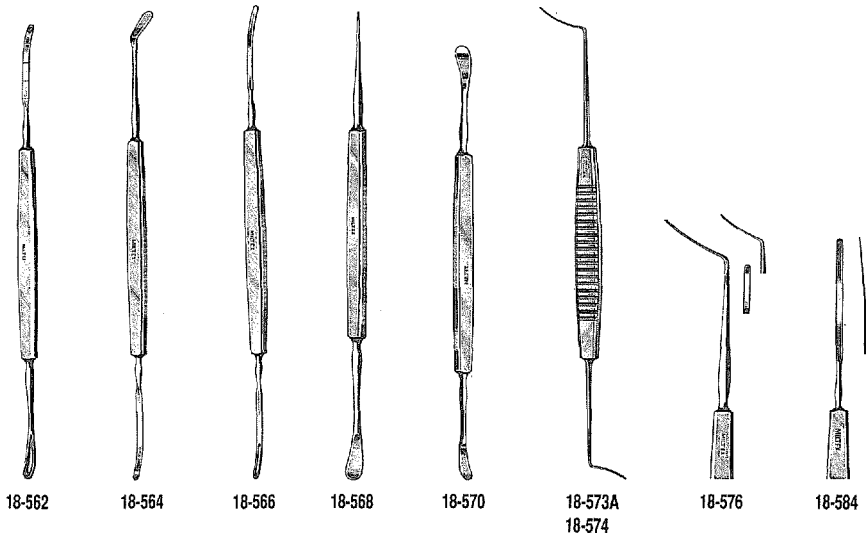

- 18-562** LINDNER Cyclodialysis Spoon and Spatula 5½" (14 cm), malleable spatula end is graduated
- 18-564** CASTROVIEJO Spatula 5½" (14 cm), double end 3.5 mm wide angled and 2 mm wide slightly curved, sterling
- 18-566** SMITH-FISHER Iris Spatula 5" (12.7 cm), one flat end 2 mm wide, one spoon end 2 mm, sterling
- 18-568** FISHER Spoon and Needle 5½" (14 cm), spoon end 7 x 15 mm, needle 33 mm long
- 18-570** GREEN Spatula 6" (15.2 cm), one end 4 x 14 mm, other end 5 x 16 mm
- 18-573A** CASTROVIEJO Cyclodialysis Spatula 5¼" (13.3 cm), blades 10 mm and 15 mm x 0.75 mm wide
- 18-574** CASTROVIEJO Cyclodialysis Spatula 5¼" (13.3 cm), blades 10 mm and 15 mm x 0.5 mm wide
- 18-576** CASTROVIEJO Cyclodialysis Spatula 5¼" (13.3 cm), blade 10 x 1 mm
- 18-584** WECKER Iris Spatula 5" (12.7 cm), sterling blade 30 x 2 mm



18-613

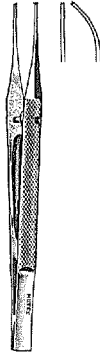

18-620
18-624

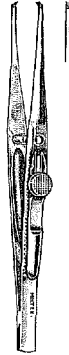

18-628

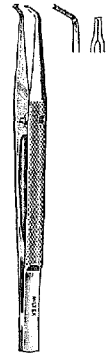

18-632

- 18-613 KIRBY Muscle Hook and Expressor 6" (15.2 cm), double end
- 18-620 KIRBY Iris Forceps 4" (10.2 cm), straight, 1 x 2 teeth
- 18-624 KIRBY Iris Forceps 4" (10.2 cm), curved, 1 x 2 teeth
- 18-628 KIRBY Fixation Forceps 4" (10.2 cm), straight 1 x 2 teeth, with slide lock
- 18-632 KIRBY Cornea-Scleral Forceps 4" (10.2 cm), angled tips with 1 x 2 teeth

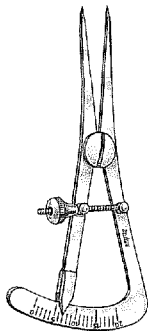

18-650

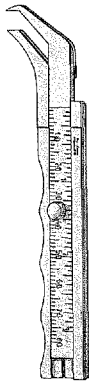

18-657



18-658

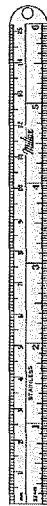

18-660



18-666

- 18-650 CASTROVIEJO Caliper $3\frac{1}{4}$ " (8.3 cm), a combination measuring and marking caliper, graduated 0-20 mm
- 18-657 THORPE Caliper $4\frac{1}{2}$ " (11.4 cm), graduated in inches and mm, permits measurements in deep areas
- 18-658 JAMESON Caliper $3\frac{3}{4}$ " (9.5 cm), graduated in inches and mm, with thin tips, chrome
- 18-660 Flexible Stainless Ruler 6" (15.2 cm) x $\frac{1}{2}$ " (1.3 cm), graduated in $\frac{1}{32}$ " (0.8 mm) fractions and mm
- 18-666 WADSWORTH-TODD Cautery $5\frac{3}{4}$ " (14.6 cm), copperhead 9 mm dia. with platinum point



18-680



18-688



18-691



18-692



18-694



18-696



18-698



18-700

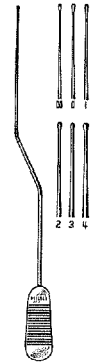

18-710 to 18-720

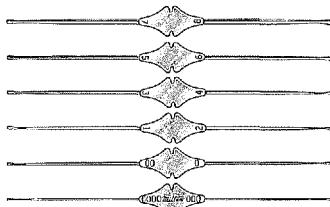

18-722 to 18-732

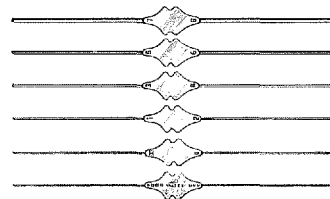

18-740 to 18-750

- 18-680 ZIEGLER Lacrimal Dilator 5½" (14 cm), double end
- 18-688 HOSFORD Lacrimal Dilator 4¾" (12.1 cm), double end
- 18-691 CASTROVIEJO Lacrimal Dilator, 5½" (14 cm), one end needle point, other end medium
- 18-692 MULDOON Lacrimal Dilator 4" (10.2 cm), with 3 mm straight tip to act as guide for tapered dilator
- 18-694 WILDER Lacrimal Dilator 4" (10.2 cm), fine taper
- 18-696 WILDER Lacrimal Dilator 4" (10.2 cm), medium taper
- 18-698 WILDER Lacrimal Dilator 4" (10.2 cm), heavy taper
- 18-700 RUEDEMANN Infant Lacrimal Dilator 3" (7.6 cm), very delicate, 0.5 mm dia. at tip

FRENCH PATTERN LACRIMAL PROBES 5" (12.7 cm)
Bayonet shape

- | | | | |
|--------|---------|--------|--------|
| 18-710 | size 00 | 18-716 | size 2 |
| 18-711 | size 0 | 18-718 | size 3 |
| 18-714 | size 1 | 18-720 | size 4 |

- | | | | |
|---|---------------|--------|----------|
| WILLIAMS LACRIMAL PROBES 5" (12.7 cm), sterling | | | |
| 18-722 | size 0000-000 | 18-728 | size 3-4 |
| 18-724 | size 00-0 | 18-730 | size 5-6 |
| 18-726 | size 1-2 | 18-732 | size 7-8 |

- | | | | |
|---|---------------|--------|----------|
| BOWMAN LACRIMAL PROBES 5" (12.7 cm), sterling | | | |
| 18-740 | size 0000-000 | 18-746 | size 3-4 |
| 18-742 | size 00-0 | 18-748 | size 5-6 |
| 18-744 | size 1-2 | 18-750 | size 7-8 |



18-780

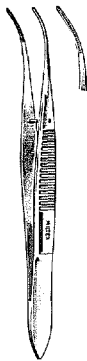

18-782

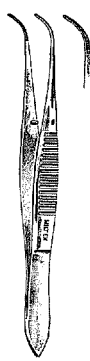

18-784



18-779

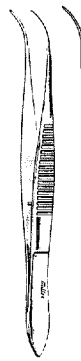

18-781

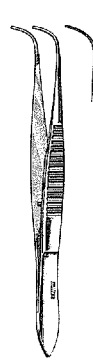

18-783

EYE DRESSING FORCEPS 4" (10.2 cm), serrated tips

Standard Pattern
0.8 mm wide tips

- 18-780 straight
- 18-782 half curved
- 18-784 full curved

Extra Delicate Pattern
0.5 mm wide tips

- 18-779 straight
- 18-781 half curved
- 18-783 full curved



18-786
18-787

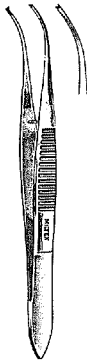

18-788

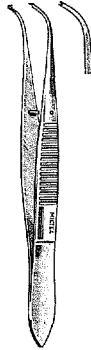

18-790



18-785

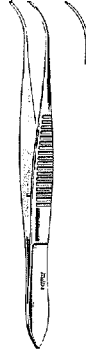

18-789

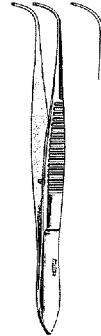

18-791

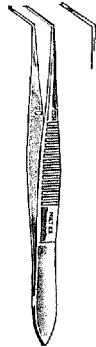

18-793

IRIS TISSUE FORCEPS 4" (10.2 cm), 1 x 2 teeth

Standard Pattern
0.8 mm wide tips

Extra Delicate Pattern
0.5 mm wide tips

18-786 straight

18-785 straight

18-787 straight (Non Magnetic)

18-789 half curved

18-788 half curved

18-791 full curved

18-790 full curved

18-793 O'CONNOR Iris Forceps 3³/₄" (9.5 cm), angular jaws 0.5 x 9 mm with 1 x 2 teeth

18-794 BRACKEN Iris Forceps 4" (10.2 cm), with fine cross-serrated tips



18-794

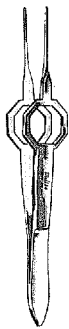

18-795
18-795A

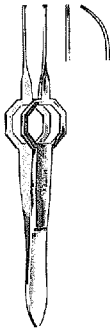

18-796
18-798



18-804



18-814
18-816



18-818
18-820

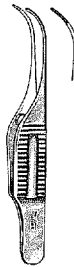

18-825

18-795 FOERSTER Eye Dressing Forceps 3 $\frac{3}{4}$ " (9.5 cm), octagonal grip, straight, serrated tips 0.5 mm wide

18-795A FOERSTER Eye Dressing Forceps 3 $\frac{3}{4}$ " (9.5 cm), octagonal grip, full curved, serrated tips 0.5 mm wide

18-796 FOERSTER Iris Tissue Forceps 3 $\frac{3}{4}$ " (9.5 cm), octagonal grip, straight, 1 x 2 teeth, 0.5 mm wide

18-798 FOERSTER Iris Tissue Forceps 3 $\frac{3}{4}$ " (9.5 cm), octagonal grip, full curved, 1 x 2 teeth, 0.5 mm wide

18-804 STEVENS Iris Forceps 4" (10.2 cm), straight, 1 x 2 teeth, 1 mm wide

18-814 GRAEFE Eye Dressing Forceps 2 $\frac{3}{4}$ " (7 cm), straight, serrated

18-816 GRAEFE Iris Forceps 2 $\frac{3}{4}$ " (7 cm), straight, 1 x 2 teeth

18-818 GRAEFE Eye Dressing Forceps 2 $\frac{3}{4}$ " (7 cm), curved, serrated

18-820 GRAEFE Iris Forceps 2 $\frac{3}{4}$ " (7 cm), curved, 1 x 2 teeth

18-825 GILL (CHANDLER) Iris Forceps 3" (7.6 cm), fine cross serrated tips, 0.6 mm wide

18-834 GILL Iris Forceps 2 $\frac{7}{8}$ " (7.3 cm), tips 0.6 mm wide, with 1 x 2 teeth

18-827 TROUTMAN-BARRAQUER Colibri Type Corneal Utility Forceps 3" (7.6 cm), with 1 x 2 teeth, 0.4 mm, set at 45° angle, with tying platform

18-828 TROUTMAN-BARRAQUER Colibri Type Corneal Utility Forceps 3" (7.6 cm), with 1 x 2 teeth, 0.12 mm, set at 45° angle, with tying platform

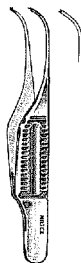

18-834



18-827
18-828

Ophthalmic Instruments

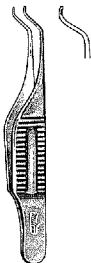

18-829

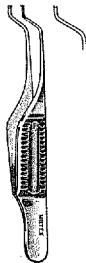

18-830



18-835



18-836



18-837
18-838

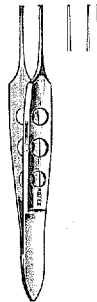

18-866 to 18-868

18-829 BOTVIN Iris Forceps 2 $\frac{1}{8}$ " (7.3 cm), fine cross serrated tips, 0.5 mm wide

18-830 GILL HESS Iris Forceps 2 $\frac{3}{4}$ " (7 cm), with 1 x 2 teeth forward 0.5 mm

18-835 BONN Micro Suturing Forceps 2 $\frac{3}{4}$ " (7 cm), 1 x 2 teeth 0.12 mm, with tying platform

18-836 BONN Micro Suturing Forceps 3 $\frac{1}{4}$ " (9.5 cm), 1 x 2 teeth 0.12 mm, with tying platform

18-837 McPHERSON Micro Corneal Suturing Forceps 3 $\frac{1}{2}$ " (8.9 cm), straight, 1 x 2 teeth 0.2 mm, with tying platform

18-838 McPHERSON Micro Corneal Suturing Forceps 3 $\frac{1}{2}$ " (8.9 cm), angled, 1 x 2 teeth 0.2 mm, with tying platform

18-866 BISHOP-HARMON Dressing Forceps 3 $\frac{3}{8}$ " (8.6 cm), fine cross serrated tips 0.5 mm wide

18-867 BISHOP-HARMON Micro Tissue Forceps 3 $\frac{3}{8}$ " (8.6 cm), delicate 0.3 mm 1 x 2 teeth

18-868 BISHOP-HARMON Tissue Forceps 3 $\frac{3}{8}$ " (8.6 cm), standard 0.7 mm 1 x 2 teeth

18-840 Strabismus Forceps 4" (10.2 cm), 1 mm wide tips with 1 x 2 teeth

18-850 GRAEFE Fixation Forceps 4 $\frac{3}{8}$ " (11.2 cm), standard jaws 4.5 mm wide, with fine teeth

18-852 GRAEFE Fixation Forceps 4 $\frac{3}{8}$ " (11.2 cm), standard jaws 4.5 mm wide, with fine teeth, Non-Magnetic

18-854 GRAEFE Fixation Forceps 4 $\frac{3}{8}$ " (11.2 cm), standard jaws 4.5 mm wide, with fine teeth, with catch

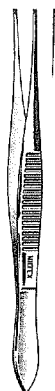

18-840



18-850
18-852



18-854

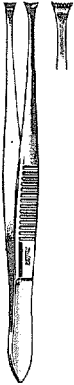

18-860

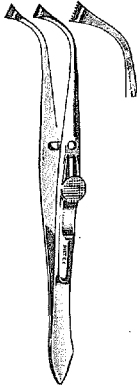

18-870

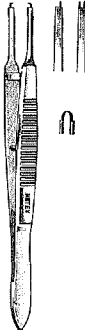

18-876
18-878

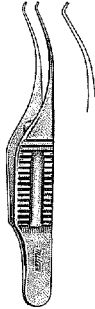

18-880
18-881



18-883

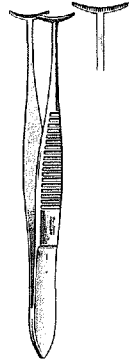

18-896
18-897

- 18-860** WALDEAU Fixation Forceps 4 $\frac{3}{8}$ " (11.2 cm), concave jaws 5 mm wide, with fine teeth
- 18-870** GUYTON-NOYES Fixation Forceps 4 $\frac{1}{4}$ " (10.8 cm), with slide catch, curved jaws, 4.5 mm wide, with fine teeth
- 18-876** CASTROVIEJO (ALVIN) Fixation Forceps 3 $\frac{3}{4}$ " (9.5 cm), straight, 1 x 1 curved teeth extending beyond each other
- 18-878** CASTROVIEJO Fixation Forceps 3 $\frac{3}{4}$ " (9.5 cm), straight, 2 x 2 curved teeth extending beyond each other
- 18-880** PIERSE Colibri Type Corneal Forceps 3 $\frac{1}{4}$ " (8.3 cm), tips 0.12 mm
- 18-881** PIERSE Colibri Type Corneal Forceps 3 $\frac{1}{4}$ " (8.3 cm), tips 0.3 mm
- 18-883** CASTROVIEJO Colibri Type Corneal Forceps 4" (10.2 cm), tips 0.12 mm, with tying platform
- 18-896** GREEN Fixation Forceps 4" (10.2 cm), T-shape, 12 mm wide 19 x 20 teeth
- 18-897** GREEN Fixation Forceps 4" (10.2 cm), T-shape, 5 mm wide 8 x 9 teeth

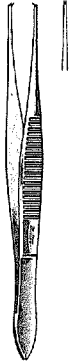

18-904



18-906



18-908



18-912



18-914

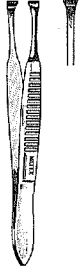

18-916

- 18-904 O'BRIEN Fixation Forceps 4" (10.2 cm), delicate 1 x 2 teeth, 0.9 mm wide, angled forward
- 18-906 ELSCHNIG Fixation Forceps 4¼" (10.8 cm), strong 1 x 2 teeth, 0.9 mm wide, angled upwards
- 18-908 ELSCHNIG-O'CONNOR Fixation Forceps 4¼" (10.8 cm), with slide lock, strong 1 x 2 teeth, 1 mm wide, angled upwards
- 18-912 LESTER Fixation Forceps ¾" (9.5 cm), delicate 1 x 2 teeth, 0.6 mm wide
- 18-914 LESTER Fixation Forceps ¾" (9.5 cm), delicate 2 x 3 teeth, 1 mm wide
- 18-916 HARMON Fixation Forceps 3" (7.6 cm), 4 x 5 teeth, delicate 2.5 mm wide jaws



18-946
18-947



18-948
18-949

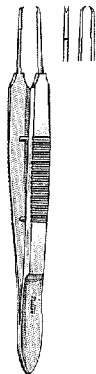

18-950

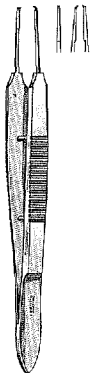

18-951
18-952

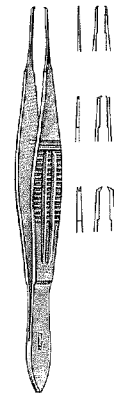

18-953 to 18-955

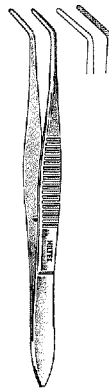

18-956
18-958



18-962
18-964

18-946 HARMS Suturing Forceps 4½" (10.5 cm), straight, with 11 mm wide handles, tying platform, 0.6 mm wide at tip
18-947 HARMS Suturing Forceps 4½" (10.5 cm), curved, with 11 mm wide handles, tying platform, 0.6 mm wide at tip

18-948 McPHERSON Micro Iris Suturing Forceps 3½" (8.9 cm), straight, smooth platform 0.3 x 5 mm, no teeth
18-949 McPHERSON Micro Iris Suturing Forceps 3½" (8.9 cm), angled, smooth platform 0.3 x 5 mm, no teeth

18-950 CASTROVIEJO Suturing Forceps 4" (10.2 cm), 1 x 2 teeth 0.9 mm, with tying platform

18-951 CASTROVIEJO Suturing Forceps 4" (10.2 cm), 1 x 2 teeth 0.3 mm, with tying platform

18-952 CASTROVIEJO Suturing Forceps 4" (10.2 cm), 1 x 2 teeth 0.6 mm, with tying platform

18-953 CASTROVIEJO Micro Suturing Forceps 4" (10.2 cm), with 11 mm wide handles, 1 x 2 teeth 0.12 mm, with tying platform

18-954 CASTROVIEJO Suturing Forceps 4" (10.2 cm), with 11 mm wide handles, 1 x 2 teeth 0.6 mm, with tying platform

18-955 CASTROVIEJO Suturing Forceps 4" (10.2 cm), with 11 mm wide handles, 1 x 2 teeth 0.9 mm, with tying platform

18-956 NUGENT Utility Forceps 4¼" (10.8 cm), smooth tips 1.2 mm wide

18-958 NUGENT Utility Forceps 4¼" (10.8 cm), cross serrated tips 1.2 mm wide

18-962 McCULLOUGH Utility Forceps 4" (10.2 cm), smooth tips 1.5 mm wide

18-964 McCULLOUGH Utility Forceps 4" (10.2 cm), cross serrated tips 1.5 mm wide

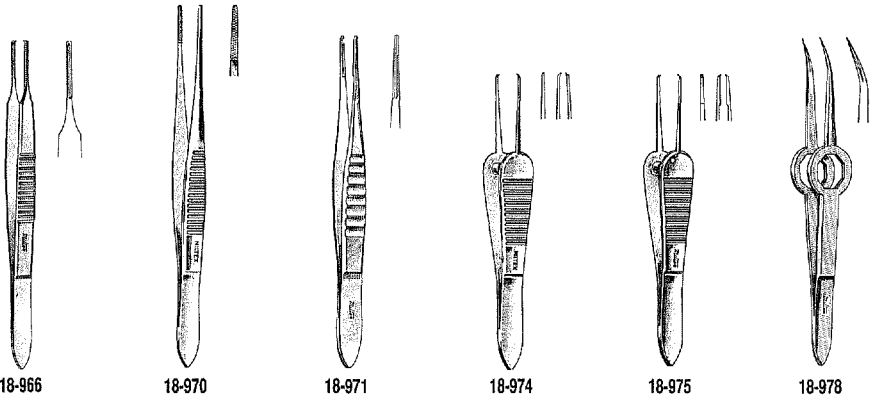

- 18-966** McCULLOUGH Suturing Forceps 4" (10.2 cm), cross serrated jaws 1.5 mm wide with 1 x 2 teeth
- 18-970** WILLS HOSPITAL Utility Forceps 4" (10.2 cm), with cross serrated tying platform 1.2 mm wide
- 18-971** BONACCOLTO Utility Forceps 4" (10.2 cm), longitudinal serrations with cross serrations on tip, 1.2 mm wide with tapered tips
- 18-974** SAUER Suturing Forceps 3½" (8.9 cm), 1 x 2 curved teeth, overlapping each other, 0.6 mm wide
- 18-975** MANHATTAN EYE & EAR Suturing Forceps 3½" (8.9 cm), with smooth platform, 1 x 2 curved teeth, overlapping each other, 0.7 mm wide
- 18-978** SCHAAF Foreign Body Forceps 3¾" (9.5 cm), grooved tips



18-980



18-1000
18-1002

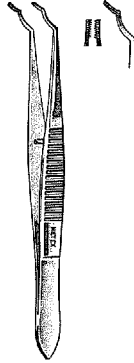

18-1034



18-1050

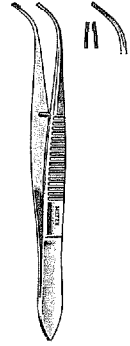

18-1058

- 18-980 THORPE Corneal and Splinter Forceps 4" (10.2 cm), very sharp points, fine serrated tips
- 18-1000 ARRUGA Capsule Forceps 4" (10.2 cm), standard curve
- 18-1002 ARRUGA Capsule Forceps 4" (10.2 cm), new curve
- 18-1034 MILTEX Extra-Capsular Forceps 4" (10.2 cm), improved pattern with 11 x 11 teeth, with long convex curve
- 18-1050 CASTROVIEJO Capsule Forceps 4" (10.2 cm), cross action, with stop to limit opening of blades
- 18-1058 SCHWEIGER Extra-Capsular Forceps 3¾" (9.5 cm), 4 x 5 teeth

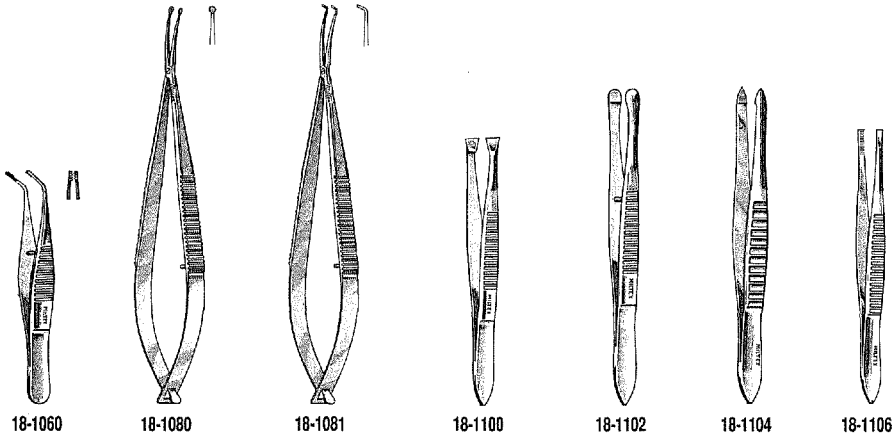

- 18-1060** FUCHS Extra-Capsular Forceps 2¾" (7 cm), 5 x 5 teeth
- 18-1080** SHEPARD Intraocular Lens Forceps 4½" (11.4 cm), 17 mm jaws, serrated tips
- 18-1081** CLAYMAN Intraocular Lens Forceps 4½" (11.4 cm), 15 mm jaws, smooth tips
- 18-1100** LITTAUER Cilia Forceps 3½" (8.9 cm), 4 mm wide jaws with fine horizontal serrations
- 18-1102** BEER Cilia Forceps 3½" (8.9 cm), 4 mm wide smooth jaws
- 18-1104** ZIEGLER Cilia Forceps 3½" (8.9 cm), 2 mm wide smooth jaws
- 18-1106** DOUGLAS Cilia Forceps 3½" (8.9 cm)), thin tips 2.5 mm wide, with fine horizontal serrations



18-1107

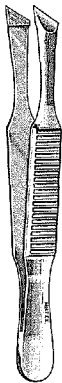

18-1108



18-1110



18-1111



18-1112



18-1114



18-1116

- 18-1107 SWISS Cilia and Suture Forceps 3¾" (9.5 cm), 3 mm wide precision fitted diagonal jaws
- 18-1108 BERGH Cilia Forceps 4¼" (10.8 cm), 10 mm wide jaws with horizontal serrations
- 18-1110 BERGH Cilia Forceps 3½" (8.9 cm), 5 mm wide jaws with horizontal serrations
- 18-1111 BARRAQUER Cilia and Suture Forceps 4½" (11.4 cm), with 5 mm smooth platform
- 18-1112 BENNETT Cilia Forceps 3" (7.6 cm), cup shaped jaws 3 mm diameter
- 18-1114 BEAUPRE Cilia Forceps 4½" (11.4 cm), smooth jaws 12 mm long, 45° angle
- 18-1116 GRADLE Cilia Forceps 4" (10.2 cm), precision ground jaws 1.4 mm wide

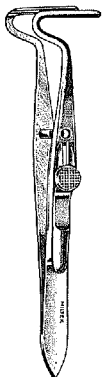

18-1136
18-1138



18-1150

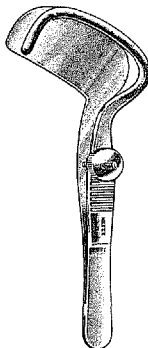

18-1160
18-1162



18-1170



18-1174



18-1178

- 18-1136 BERKE Ptosis Forceps 4" (10.2 cm), blades 20 mm long with longitudinal serrations, with slide lock
- 18-1138 BERKE Ptosis Forceps 4" (10.2 cm), blades 27 mm long with longitudinal serrations, with slide lock
- 18-1150 ERHARDT Lid Forceps 3½" (8.9 cm), serrated jaw 9.5 mm wide
- 18-1160 SNELLEN Entropium Forceps 3½" (8.9 cm), left, 35 mm wide plate
- 18-1162 SNELLEN Entropium Forceps 3½" (8.9 cm), right, 35 mm wide plate
- 18-1170 AYER Chalazion Forceps 3½" (8.9 cm), inside ring diameter 8.5 mm, solid blade 8 mm diameter
- 18-1174 LAMBERT Chalazion Forceps 3½" (8.9 cm), inside ring diameter 8 mm
- 18-1178 HUNT Chalazion Forceps 3¾" (9.5 cm), inside ring diameter 12 mm
- 18-1182 HEATH Chalazion Forceps 4" (10.2 cm), inside ring measures 12 x 14 mm



18-1182

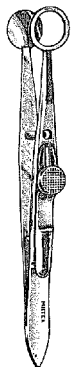

18-1188



18-1190

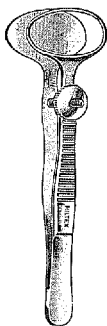

18-1200 to 18-1204

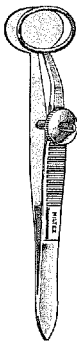

18-1208

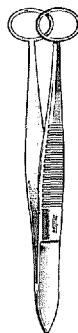

18-1220

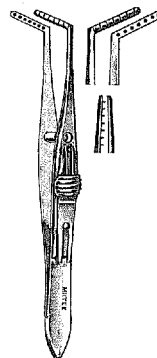

18-1260
18-1262

- 18-1188** SPENCER Chalazion Forceps 4" (10.2 cm), inside ring diameter 10 mm, with slide lock
- 18-1190** WIES Chalazion Forceps 4" (10.2 cm), inside ring measures 9 x 12 mm
- 18-1200** DESMARRES Chalazion Forceps 3½" (8.9 cm), small size, inside ring measures 11 x 17 mm
- 18-1202** DESMARRES Chalazion Forceps 3½" (8.9 cm), medium size, inside ring measures 12 x 23 mm
- 18-1204** DESMARRES Chalazion Forceps 3½" (8.9 cm), large size, inside ring measures 17 x 28 mm
- 18-1208** FRANCIS Chalazion Forceps 3¾" (9.5 cm), inside ring measures 12 x 14 mm
- 18-1220** PRINCE Trachoma Forceps 3½" (8.9 cm), rings measure 8 x 10 mm inside
- 18-1260** JAMESON Recession Forceps 3¾" (9.5 cm), left, with slide lock
- 18-1262** JAMESON Recession Forceps 3¾" (9.5 cm), right, with slide lock

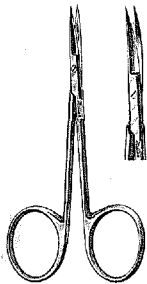

18-1392
18-1394

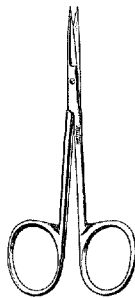

18-1396

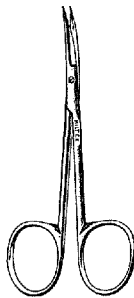

18-1398

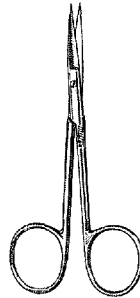

5-300
5-304

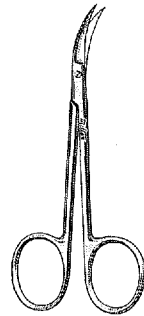

5D-303

- 18-1392 BONN Miniature Iris Scissors 3½" (8.9 cm), with 15 mm blades, straight
- 18-1394 BONN Miniature Iris Scissors 3½" (8.9 cm), with 15 mm blades, curved
- 18-1396 Iris Scissors 3½" (8.9 cm), with 20 mm blades, straight, delicate
- 18-1398 Iris Scissors 3½" (8.9 cm), with 20 mm blades, curved, delicate
- 5-300 Iris Scissors 4" (10.2 cm), straight, standard pattern
- 5-302 Iris Scissors 4" (10.2 cm), curved, standard pattern
- 5D-303 Iris Scissors 4½" (11.4 cm), curved sideways
- 5-304 Iris Scissors 4½" (11.4 cm), straight, standard pattern
- 5-306 Iris Scissors 4½" (11.4 cm), curved, standard pattern
- 5-308 Iris Scissors 4½" (11.4 cm), angular

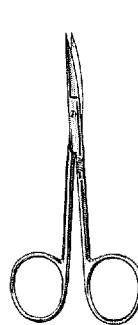

5-302
5-306

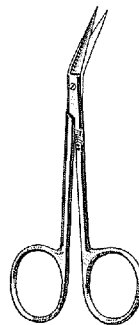

5-308



Ophthalmic Instruments

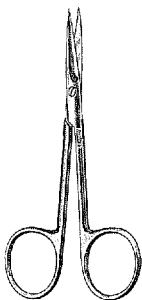

18-1404

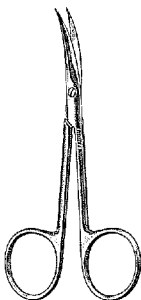

18-1405

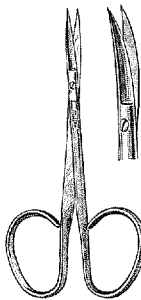

18-1415*
18-1416*

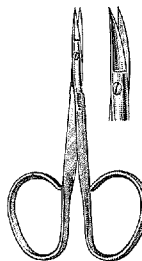

18-1417*
18-1418*

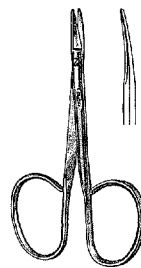

18-1419*

18-1404 MILTEX Iris Scissors 4" (10.2 cm), straight, heavy pattern

18-1405 MILTEX Iris Scissors 4" (10.2 cm), curved, heavy pattern

18-1415* Iris Scissors 4" (10.2 cm), straight, standard pattern, ribbon type

18-1416* Iris Scissors 4" (10.2 cm), curved, standard pattern, ribbon type

18-1417* Iris Scissors 3 3/4" (9.5 cm), straight, miniature pattern with 14 mm blades, ribbon type

18-1418* Iris Scissors 3 3/4" (9.5 cm), curved, miniature pattern with 14 mm blades, ribbon type

18-1419* Utility Scissors 3 3/4" (9.5 cm), curved blunt blades, 15 mm long, ribbon type

*Ribbon Type Scissors have extra large finger rings;
shanks and rings have satin finish;
blades are highly polished.

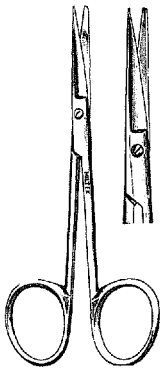

18-1420
18-1422

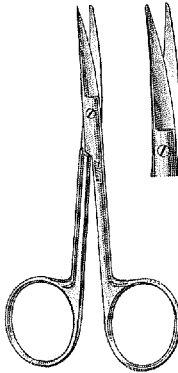

18-1426
18-1428

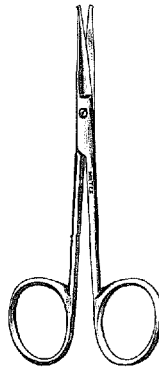

18-1430

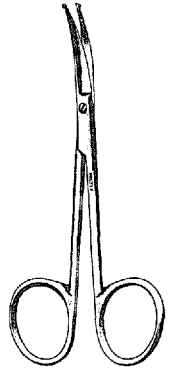

18-1432

- 18-1420 KNAPP Iris Scissors 4" (10.2 cm), straight, sharp-blunt points
- 18-1422 KNAPP Iris Scissors 4" (10.2 cm), straight, blunt-blunt points
- 18-1426 KNAPP Iris Scissors 4" (10.2 cm), curved, sharp-blunt points
- 18-1428 KNAPP Iris Scissors 4" (10.2 cm), curved, blunt-blunt points
- 18-1430 Eye Scissors 4" (10.2 cm), with probe points, straight
- 18-1432 Eye Scissors 4" (10.2 cm), with probe points, curved
- 5-310 Eye Scissors 4½" (11.4 cm), with probe points, angled on side

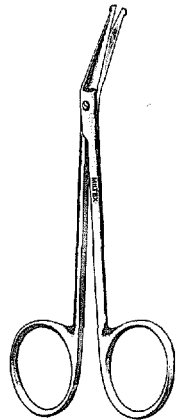

5-310



Ophthalmic Instruments

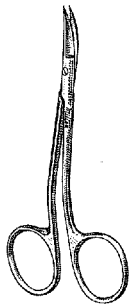

5D-324

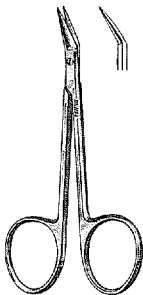

18-1440

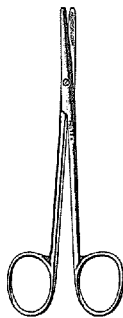

5-312



5-314

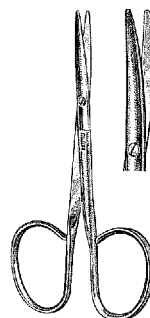

18-1453*
18-1454*

- 5D-324** LAGRANGE Sclerectomy Scissors 4¼" (10.8 cm), curved, one serrated blade, angled shanks
- 18-1440** WILMER Conjunctival and Utility Scissors, 4" (10.2 cm), angled on flat
- 5-312** Strabismus Scissors 4" (10.2 cm), straight, standard pattern
- 5-314** Strabismus Scissors 4" (10.2 cm), curved, standard pattern
- 18-1453*** Strabismus Scissors 4¼" (10.8 cm), straight, ribbon type
- 18-1454*** Strabismus Scissors 4¼" (10.8 cm), curved, ribbon type

STEVENS TENOTOMY SCISSORS

4½" (10.5 cm)
With Short Blades

- 18-1460** Straight Sharp Points
- 18-1462** Straight Blunt Points
- 18-1464** Curved Sharp Points
- 18-1466** Curved Blunt Points

4½" (11.4 cm)
With Long Blades

- 18-1470**
- 18-1472**
- 18-1474**
- 18-1476**



18-1460 to 18-1476

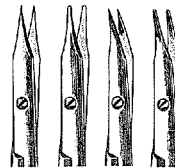

18-1460 to 18-1466

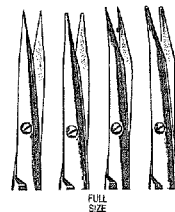

18-1470 to 18-1476

*Ribbon Type Scissors have extra large finger rings; shanks and rings have satin finish; blades are highly polished.

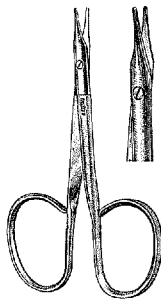

18-1477*
18-1478*

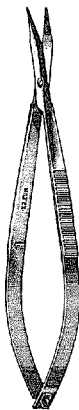

18-1480



18-1482



18-1484



18-1486

- 18-1477* STEVENS Tenotomy Scissors 3¾" (9.5 cm), straight, blunt points, ribbon type
- 18-1478* STEVENS Tenotomy Scissors 3¾" (9.5 cm), curved, blunt points, ribbon type
- 18-1480 WESTCOTT Utility Scissors 4½" (11.4 cm), curved, blunt tips
- 18-1482 SCHEIE-WESTCOTT Corneal Section Scissors 5" (12.7 cm), right, curved, blunt tips
- 18-1484 SCHEIE-WESTCOTT Corneal Section Scissors 5" (12.7 cm), left, curved, blunt tips
- 18-1486 WESTCOTT Stitch Scissors 4½" (11.4 cm), curved, sharp points
- 18-1487 WESTCOTT Tenotomy Scissors 5¼" (13.3 cm), right, wide handles
- 18-1488 WESTCOTT Tenotomy Scissors 5¼" (13.3 cm), left, wide handles

*Ribbon Type Scissors have extra large finger rings; shanks and rings have satin finish; blades are highly polished.

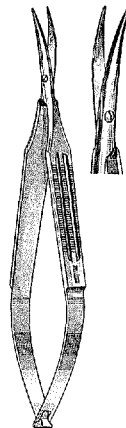

18-1487
18-1488

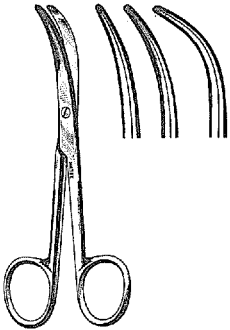

18-1494 to 18-1498

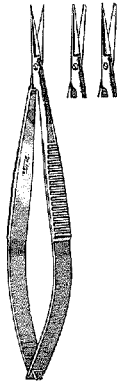

18-1510 to 18-1514



18-1516

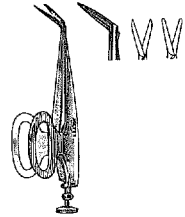

18-1520
18-1521

- 18-1494 Enucleation Scissors 5" (12.7 cm), light curve
- 18-1496 Enucleation Scissors 5" (12.7 cm), medium curve
- 18-1498 Enucleation Scissors 5" (12.7 cm), full curve
- 18-1510 NOYES Iris Scissors 4½" (11.4 cm), straight, sharp-sharp points
- 18-1512 NOYES Iris Scissors 4½" (11.4 cm), straight, sharp-blunt points
- 18-1514 NOYES Iris Scissors 4½" (11.4 cm), straight, blunt-blunt points
- 18-1516 NOYES Iris Scissors 4½" (11.4 cm), curved, sharp-sharp points
- 18-1520 BARRAQUER Iris Scissors 2¼" (5.7 cm), angled 7 mm blades, sharp points
- 18-1521 BARRAQUER Iris Scissors 2¼" (5.7 cm), angled 7 mm blades, blunt points
- 18-1524 DeWECKER Iris Scissors 4¼" (10.8 cm), angled 7 mm blades, sharp-sharp points



18-1524

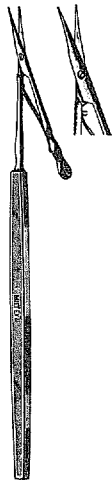

18-1540

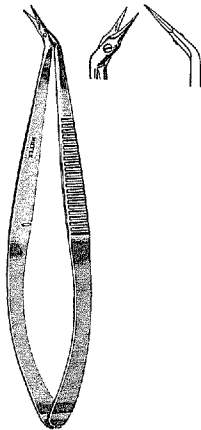

18-1550
18-1552

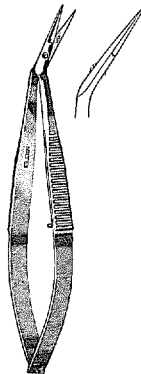

18-1554



18-1558
18-1559

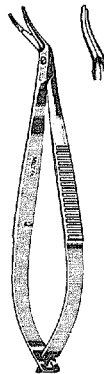

18-1560

- 18-1540 NOYES Iridectomy Scissors 5½" (14 cm), straight 7 mm blades, sharp-sharp points
- 18-1550 McCURE Iris Scissors 3¾" (9.5 cm), angled over edge, 4 mm blades with very delicate sharp points
- 18-1552 McCURE Iris Scissors 3¾" (9.5 cm), angled on flat, 4 mm blades with very delicate sharp points
- 18-1554 McCURE Iris Scissors 3¾" (9.5 cm), angled on flat, regular 10 mm blades with sharp points
- 18-1558 CASTROVIEJO Corneal Scissors 4" (10.2 cm), right, sub-miniature for micro surgery, 6 mm blades
- 18-1559 CASTROVIEJO Corneal Scissors 4" (10.2 cm), left, sub-miniature for micro surgery, 6 mm blades
- 18-1560 CASTROVIEJO Corneal Section Scissors 4½" (11.4 cm), right, inner blade 1 mm longer, blunt tips
- 18-1562 CASTROVIEJO Corneal Section Scissors 4½" (11.4 cm), left, inner blade 1 mm longer, blunt tips

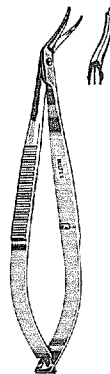

18-1562



Ophthalmic Instruments



18-1570
18-1572

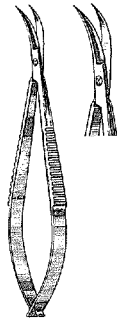

18-1576



18-1578

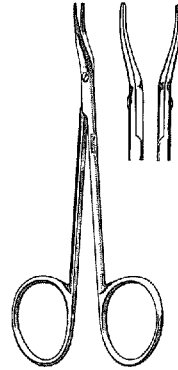

18-1594
18-1596

18-1570 CASTROVIEJO Keratoplasty Scissors 3 3/4" (9.5 cm), angled blades
11 mm, sharp points

18-1572 CASTROVIEJO Corneal Scissors 3 3/4" (9.5 cm), angled blades
11 mm, blunt points

18-1576 CASTROVIEJO Corneal Scissors 3 3/4" (9.5 cm), curved, sharp points

18-1578 CASTROVIEJO Corneal Scissors 3 3/4" (9.5 cm), curved, blunt points

18-1594 McGUIRE Corneal Scissors 4 1/8" (10.5 cm), right

18-1596 McGUIRE Corneal Scissors 4 1/8" (10.5 cm), left

18-1600 AEBLI Corneal Scissors 4" (10.2 cm), straight

18-1602 AEBLI Corneal Scissors 4" (10.2 cm), angled on flat, right

18-1604 AEBLI Corneal Scissors 4" (10.2 cm), angled on flat, left

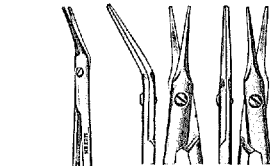

18-1600 to 18-1604

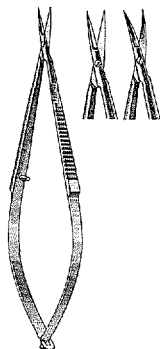

18-1618
18-1619

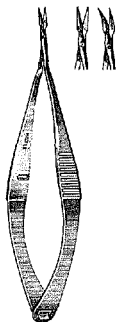

18-1620
18-1622

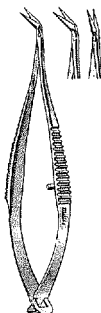

18-1623
18-1624

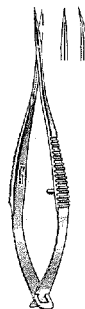

18-1625
18-1626

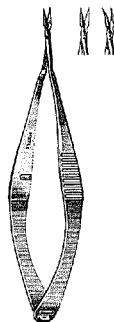

18-1630
18-1631

- 18-1618 Micro Iris Scissors 4" (10.2 cm), straight, sharp points
- 18-1619 Micro Iris Scissors 4" (10.2 cm), curved, sharp points
- 18-1620 VANNAS Capsulotomy Scissors 3/4" (8.3 cm), straight, very delicate sharp points
- 18-1622 VANNAS Capsulotomy Scissors 3/4" (8.3 cm), curved, very delicate sharp points
- 18-1623 VANNAS Capsulotomy Scissors 3/4" (8.3 cm), angled to side, very delicate sharp points
- 18-1624 VANNAS Capsulotomy Scissors 3/4" (8.3 cm), angled on flat, very delicate sharp points
- 18-1625 McPHERSON-VANNAS Micro Iris Scissors 3/4" (8.3 cm), straight, sharp points
- 18-1626 McPHERSON-VANNAS Micro Iris Scissors 3/4" (8.3 cm), curved, sharp points
- 18-1630 Micro-VANNAS Scissors 3/4" (8.3 cm), straight ultra fine blades
- 18-1631 Micro-VANNAS Scissors 3/4" (8.3 cm), curved ultra fine blades
- 18-1633 Micro Scissors 3/4" (8.3 cm), straight super fine blades
- 18-1634 Micro Scissors 3/4" (8.3 cm), curved super fine blades
- 18-1716 HOLTZ Corneoscleral Punch 3/2" (8.9 cm), 1 mm bite
- 18-1718 HOLTZ Corneoscleral Punch 3/2" (8.9 cm), 1.5 mm bite

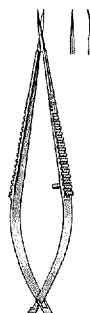

18-1633
18-1634

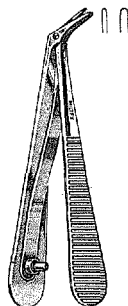

18-1716
18-1718

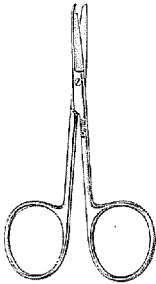

9-100

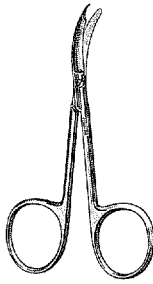

9-101

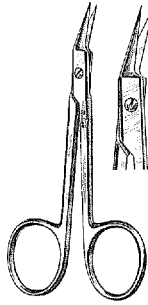

9-110

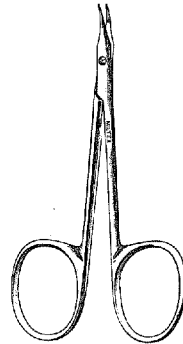

18-1652

- 9-100 SPENCER Stitch Scissors 3½" (8.9 cm), straight, delicate
- 9-101 SHORTBENT Stitch Scissors 3½" (8.9 cm), curved to side, delicate
- 9-110 O'BRIEN Stitch Scissors 3¾" (9.5 cm), angled to side, sharp points
- 18-1652 Eye Suture (GRADLE) Scissors 3¾" (9.5 cm), slightly curved, sharp points
- 18-1653* Eye Suture Scissors 4" (10.2 cm), ribbon type, slightly curved, sharp points

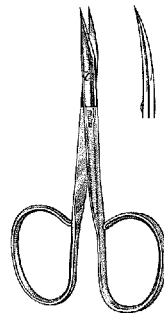

18-1653*

*Ribbon Type Scissors have extra large finger rings; shanks and rings have satin finish; blades are highly polished.

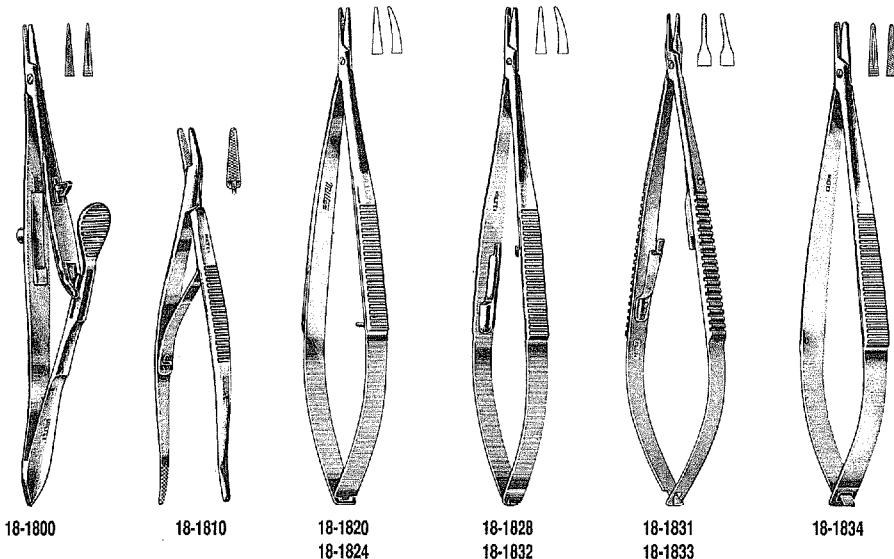

- 18-1800** KALT Needle Holder 5¼" (13.3 cm), standard model, delicate jaws
- 18-1810** GREEN Needle Holder and Suturing Forceps 4¼" (10.8 cm), angled jaws, double end
- 18-1820** CASTROVIEJO Needle Holder 5½" (14 cm), straight, without lock
- 18-1824** CASTROVIEJO Needle Holder 5½" (14 cm), curved, without lock
- 18-1828** CASTROVIEJO Needle Holder 5½" (14 cm), straight, with lock
- 18-1832** CASTROVIEJO Needle Holder 5½" (14 cm), curved, with lock
- 18-1831** CASTROVIEJO Needle Holder 5½" (14 cm), straight, extra delicate jaws, with lock
- 18-1833** CASTROVIEJO Needle Holder 5½" (14 cm), curved, extra delicate jaws, with lock
- 18-1834** PATON Needle Holder 4½" (11.4 cm), straight, without lock

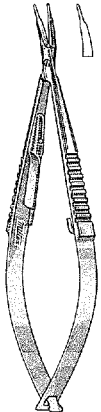

18-1837

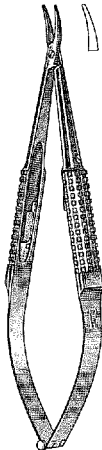

18-1838
18-1839

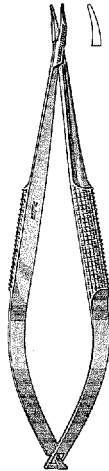

18-1840

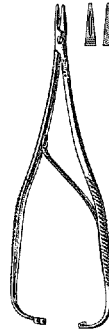

8-26



18-1858

- 18-1837 McPHERSON Needle Holder for microsurgery 4" (10.2 cm), curved smooth tapered jaws
- 18-1838 BARRAQUER Needle Holder 5" (12.7 cm), curved, without lock, 10 mm wide hollow round handle
- 18-1839 BARRAQUER Needle Holder 5" (12.7 cm), curved, with lock, 10 mm wide hollow round handle
- 18-1840 BARRAQUER Needle Holder 5½" (13 cm), curved, without lock delicate tapered jaws, 8 mm wide round handle
- 8-26 BOYNTON Needle Holder 5" (12.7 cm), delicate
- 18-1858 STEVENS Needle Holder 6½" (16.5 cm), with ratchet lock

CARN-N-SERT NEEDLE HOLDERS

with tungsten carbide inserts insure firm holding of needles and sutures

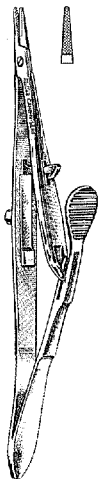

18-1800TC

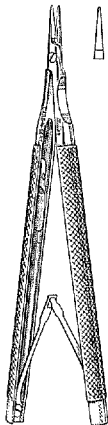

18-1816TC

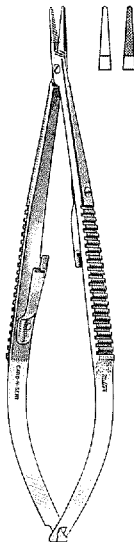

18-1828TC
18-1828A-TC

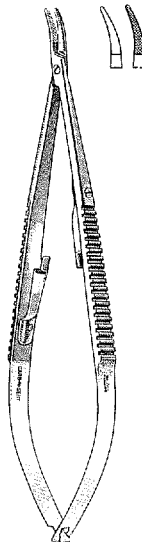

18-1832TC
18-1832A-TC

- 18-1800TC** KALT Needle Holder 5½" (14 cm), serrated Carb-N-Sert jaws 16000 teeth p. sq. inch
- 18-1816TC** MILTEX-CASTROVIEJO Needle Holder 4¾" (10.5 cm), round handles, with lock, delicate smooth Carb-N-Sert jaws
- 18-1828TC** CASTROVIEJO Needle Holder 5½" (14 cm), straight, with lock, smooth Carb-N-Sert jaws
- 18-1828A-TC** CASTROVIEJO Needle Holder 5½" (14 cm), straight, with lock, serrated Carb-N-Sert jaws 16000 teeth p. sq. inch
- 18-1832TC** CASTROVIEJO Needle Holder 5½" (14 cm), curved, with lock, smooth Carb-N-Sert jaws
- 18-1832A-TC** CASTROVIEJO Needle Holder 5½" (14 cm), curved, with lock, serrated Carb-N-Sert jaws 16000 teeth p. sq. inch



7-280
7-284



7-290
7-294



7-310



7-315

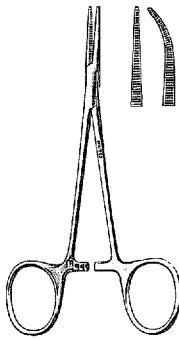

7-8 18-1934
7-10 18-1936

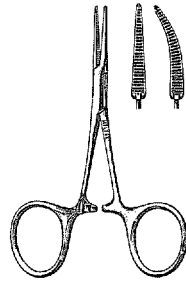

7-24
7-26

- 7-280 Serrefine 1½" (3.8 cm), straight, with suture hole
 7-284 Serrefine 2½" (6.4 cm), straight, with suture hole
 7-290 Serrefine 1½" (3.8 cm), curved, with suture hole
 7-294 Serrefine 2½" (6.4 cm), curved, with suture hole
 7-310 DIETHRICH Micro Bulldog clamp 1⅞" (4.7 cm), straight jaws 8 mm x 1.2 mm
 7-315 DIETHRICH Micro Bulldog clamp 1¾" (4.4 cm), angled jaws 8 mm x 1.2 mm
 7-8 HALSTED Mosquito Forceps 5" (12.7 cm), straight, extra delicate
 7-10 HALSTED Mosquito Forceps 5" (12.7 cm), curved, extra delicate
 18-1934 HALSTED Mosquito Forceps 5" (12.7 cm), straight, Non-Magnetic
 18-1936 HALSTED Mosquito Forceps 5" (12.7 cm), curved, Non-Magnetic
 7-24 HARTMAN Mosquito Forceps 3½" (8.9 cm), straight, delicate
 7-26 HARTMAN Mosquito Forceps 3½" (8.9 cm), curved, delicate
 17-2600 JACOBSON Micro Mosquito Forceps 5" (12.7 cm), straight, extremely delicate
 17-2602 JACOBSON Micro Mosquito Forceps 5" (12.7 cm), curved, extremely delicate

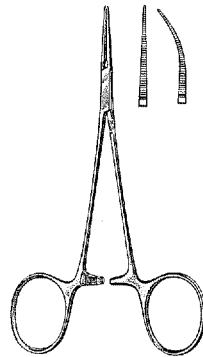

17-2600
17-2602

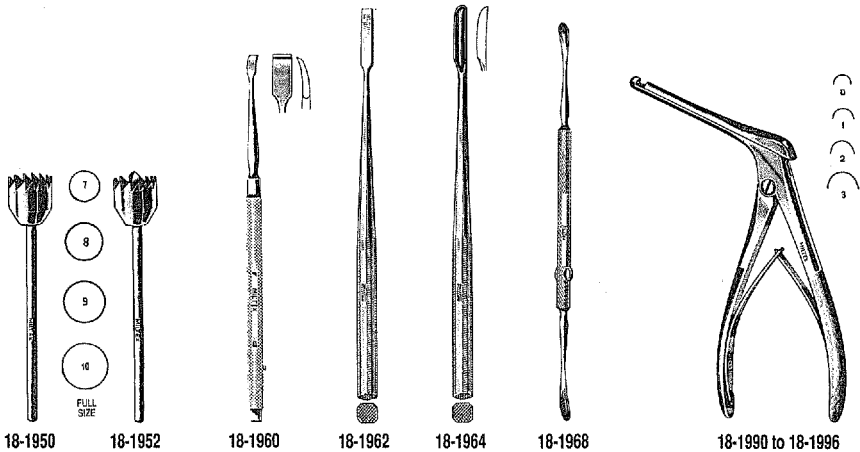

18-1950

18-1952

18-1960

18-1962

18-1964

18-1968

18-1990 to 18-1996

ARRUGA LACRIMAL TREPHINES

Without Center Point	Diameter	Center Point
18-1950-7	7 mm	18-1952-7
18-1950-8	8 mm	18-1952-8
—	9 mm	18-1952-9
—	10 mm	18-1952-10

- 18-1960 FREER Chisel 6½" (16.5 cm), curved blade 4 mm wide
- 18-1962 WEST Lacrimal Sac Chisel 6¼" (15.9 cm), straight blade 5 mm wide
- 18-1964 WEST Lacrimal Gouge 6¼" (15.9 cm), straight blade 4.5 mm wide
- 18-1968 FREER Elevator 7" (17.8 cm), double end sharp and blunt blades 5 mm wide
- 18-1990 KERRISON RONGEUR 3" (7.6 cm) shaft, size 0, 3.5 mm bite
- 18-1992 KERRISON RONGEUR 3" (7.6 cm) shaft, size 1, 4 mm bite
- 18-1994 KERRISON RONGEUR 3" (7.6 cm) shaft, size 2, 4.5 mm bite
- 18-1996 KERRISON RONGEUR 3" (7.6 cm) shaft, size 3, 5 mm bite
- 18-2200 FOX Eye Shields, aluminum, pkg. 12

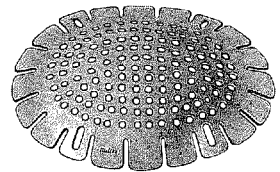

18-2200

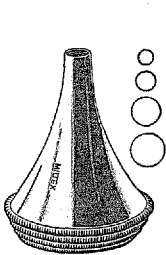

19-2

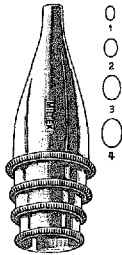

19-10 to 19-20

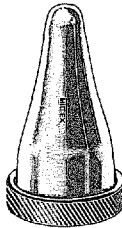

19-10A

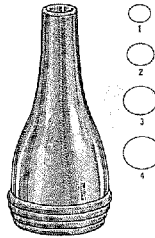

19-21 to 19-25

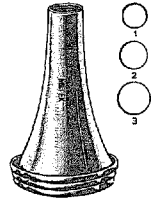

19-30 to 19-36

BOUCHERON EAR SPECULA, Round, Chrome

- 19-2** Set of 4 sizes 1, 2, 3 and 4
- 19-2-1** Single size 1 4.5 mm
- 19-2-2** Single size 2 5.5 mm
- 19-2-3** Single size 3 6.5 mm
- 19-2-4** Single size 4 7.5 mm

GRUBER EAR SPECULA, Oval, Child and Infant Sizes, Light Short Pattern, Chrome

- 19-10** Set of 4 sizes 1, 2, 3 and 4 with screw top case
- 19-12** Set of 4 sizes 1, 2, 3 and 4 without case
- 19-14** Single size 1 2x3 mm
- 19-16** Single size 2 3x4 mm
- 19-18** Single size 3 4x5 mm
- 19-20** Single size 4 5x6 mm

- 19-10A** Case only for set of 4 Gruber Specula, child & infant sizes

GRUBER EAR SPECULA, Oval, Standard Adult Sizes, Long Pattern, Chrome

- 19-21** Set of 4 sizes 1, 2, 3 and 4
- 19-22** Single size 1 4x5 mm
- 19-23** Single size 2 5x6 mm
- 19-24** Single size 3 6x7 mm
- 19-25** Single size 4 7x8 mm

TOYNBEE EAR SPECULA, Round, Chrome

- 19-30** Set of 3 sizes 1, 2 and 3
- 19-32** Single size 1 4 mm
- 19-34** Single size 2 5 mm
- 19-36** Single size 3 6 mm

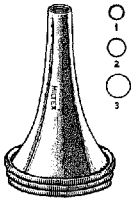

19-40

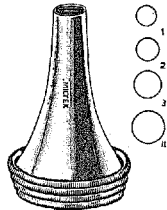

19-48

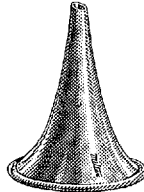

19-50

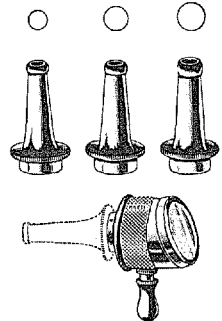
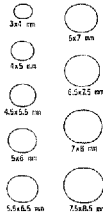

19-70
19-71

HARTMAN EAR SPECULA, Round

- 19-40 Set of 3 sizes 3, 4 and 5 mm
- 19-48 Set of 4 sizes 4, 5, 6 and 7 mm
- 19-48-A Single size 3 mm
- 19-48-B Single size 4 mm
- 19-48-C Single size 5 mm
- 19-48-D Single size 6 mm
- 19-48-E Single size 7 mm

FARRIOR EAR SPECULA, Oval, angled end, nonglare stainless

- 19-50-1 Single size 1 3 x 4 mm
- 19-50-2 Single size 2 4 x 5 mm
- 19-50-3 Single size 3 4.5 x 5.5 mm
- 19-50-4 Single size 4 5 x 6 mm
- 19-50-5 Single size 5 5.5 x 6.5 mm
- 19-50-6 Single size 6 6 x 7 mm
- 19-50-7 Single size 7 6.5 x 7.5 mm
- 19-50-8 Single size 8 7 x 8 mm
- 19-50-9 Single size 9 7.5 x 8.5 mm

19-70 BRUENING Magnifier Otoscope, Chrome, 3.5x magnif., with 3 specula, small, medium and large sizes; complete with inflation bulb and tubing, in fitted case

- 19-71 Set of 3 specula, small, medium and large sizes for Bruening Otoscope, chrome
- 19-71-1 Single speculum, small size, chrome
- 19-71-2 Single speculum, medium size, chrome
- 19-71-3 Single speculum, large size, chrome

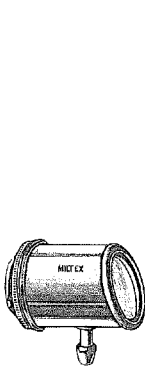

19-74

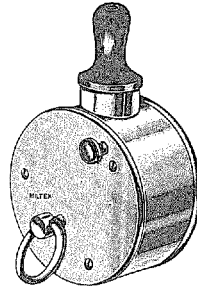
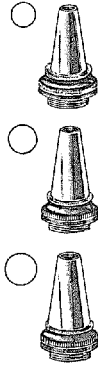

19-78

- 19-74 SIEGEL Magnifier Oscope, chrome, 3.15x magnif., with 3 specula, small, medium and large sizes; complete with inflation bulb and tubing
- 19-75 Rubber Bulb with tubing for Bruening and Siegel Oscopes
- 19-78 BARANY Noise Apparatus, with hard rubber ear tip

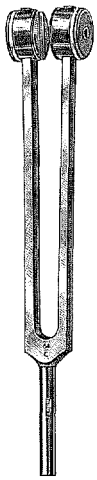

19-100

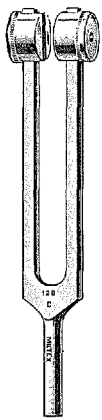

19-102

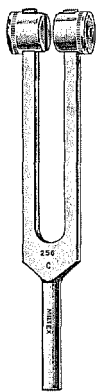

19-104

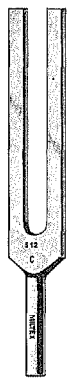

19-106



19-108

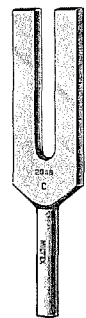

19-110

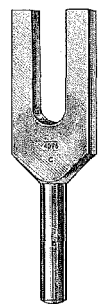

19-112

MILTEX TUNING FORKS,
Aluminum Alloy

- 19-100 C-64 vibrations
- 19-102 C-128 vibrations
- 19-104 C-256 vibrations
- 19-106 C-512 vibrations
- 19-108 C-1024 vibrations
- 19-110 C-2048 vibrations
- 19-112 C-4096 vibrations

19-120 Set of 5 Tuning Forks,
C-128, C-256, C-512,
C-1024 and C-2048 in
fitted molded vinyl
zippered case

19-120A Fitted molded vinyl zippered
case only for tuning fork set

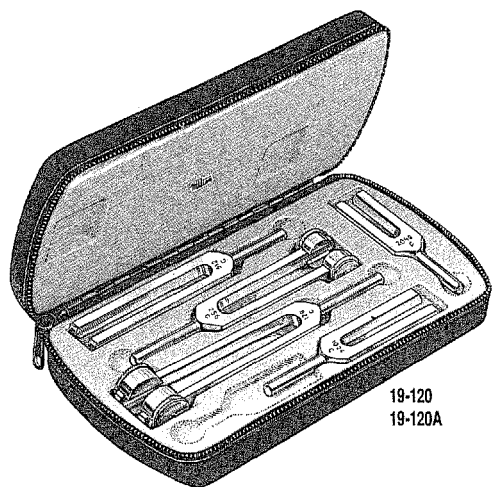

19-120
19-120A

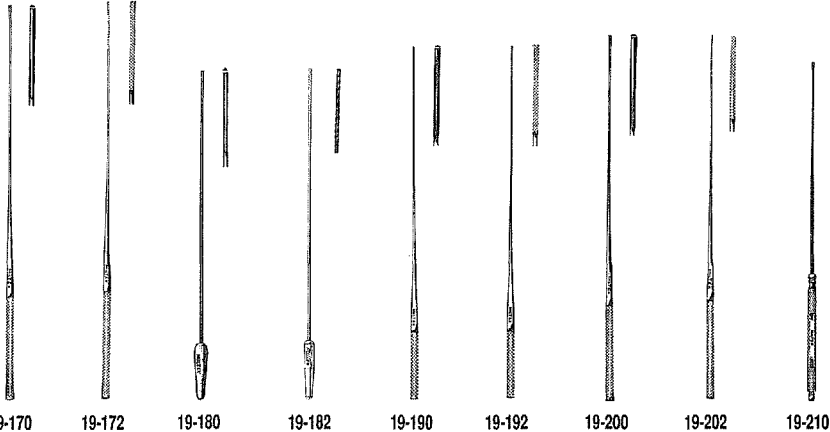

- 19-170 UEBE Applicator 7" (17.8 cm), triangular tip
- 19-172 UEBE Applicator 7" (17.8 cm), cross serrated tip
- 19-180 BROWN Applicator 6" (15.2 cm), triangular tip, copper
- 19-182 BROWN Applicator 6" (15.2 cm), cross serrated tip, copper
- 19-190 LATHBURY Applicator 5½" (14 cm), triangular tip
- 19-192 LATHBURY Applicator 5½" (14 cm), cross serrated tip
- 19-200 FARRELL Applicator 6½" (16.5 cm), triangular tip
- 19-202 FARRELL Applicator 6½" (16.5 cm), cross serrated tip
- 19-210 BUCK (SPENCER) Ear Probe 5½" (14 cm), sterling shaft
- 19-220 DAY Ear Hook 6½" (16.5 cm), small size
- 19-222 DAY Ear Hook 6½" (16.5 cm), large size
- 19-226 ALLPORT Mastoid Searcher 6½" (16.5 cm), with ball tip
- 19-228 GROSS Ear Hook and Spoon 5" (12.7 cm)

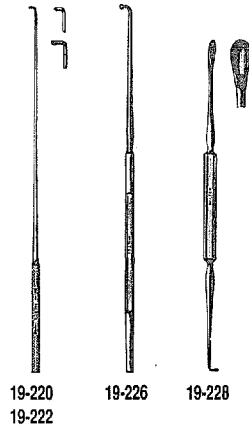

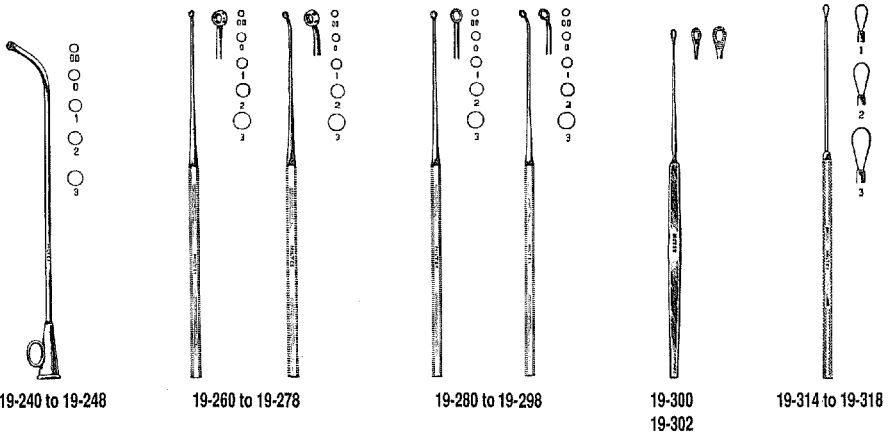

HARTMAN EUSTACHIAN CATHETERS, bulbous tip, silver plated

19-240	Size 00	19-246	Size 2
19-242	Size 0	19-248	Size 3
19-244	Size 1		

BUCK EAR CURETTES, 6½" (16.5 cm)

SHARP			BLUNT	
Straight	Angled	Size	Straight	Angled
19-260	19-270	00	19-280	19-290
19-262	19-272	0	19-282	19-292
19-264	19-274	1	19-284	19-294
19-266	19-276	2	19-286	19-296
19-268	19-278	3	19-288	19-298

19-300 SHAPLEIGH Ear Curette 6" (15.2 cm), small size, serrated loop
19-302 SHAPLEIGH Ear Curette 6" (15.2 cm), large size, serrated loop

19-314 BILLEAU Flexible Ear Loop 6½" (16.5 cm), small size No. 1
19-316 BILLEAU Flexible Ear Loop 6½" (16.5 cm), medium size No. 2
19-318 BILLEAU Flexible Ear Loop 6½" (16.5 cm), large size No. 3

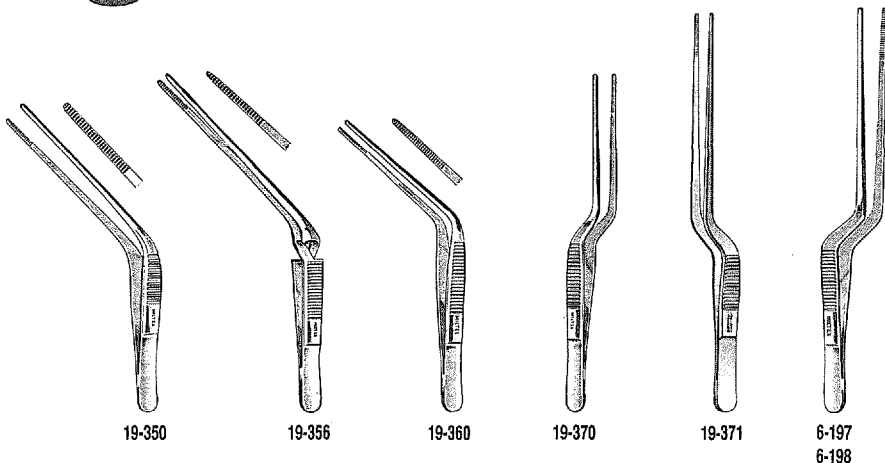

- 19-350** WILDE Ear Forceps 5" (12.7 cm), angular with serrated tips
- 19-356** WILDE Ear Forceps 5¼" (13.3 cm), cross action, angular with serrated tips
- 19-360** BLAKE Ear Forceps 4½" (11.4 cm), very delicate, angular with serrated tips
- 19-370** LUCAE Ear Forceps 5½" (14 cm), bayonet shape with serrated tips
- 19-371** JANSEN Ear Forceps 6¼" (15.9 cm), bayonet, extra delicate with 2 mm wide serrated tips
- 6-197** JANSEN (GRUENWALD) Ear Forceps 6¼" (15.9 cm), bayonet shape with serrated tips
- 6-198** ADSON Bayonet Dressing Forceps 8¼" (21 cm), serrated tips

EAR SYRINGES, All Brass, Chrome Plated, with precision ground plunger, shaft graduated in ½ (.015 liter) ounces, complete with one tapered and one short bulbous tip, easily disassembled for sterilization.

Without Shield	Capacity	With Shield
19-380	2 oz. (.06 liter)	19-381
19-382	3 oz. (.09 liter)	19-383
19-384	4 oz. (.12 liter)	19-385

- 19-390** Short Bulbous Tip only, for Ear Syringes, chrome
- 19-394** Taper Tip only, for Ear Syringes, chrome
- 19-396** Shield only, for Ear Syringes, chrome

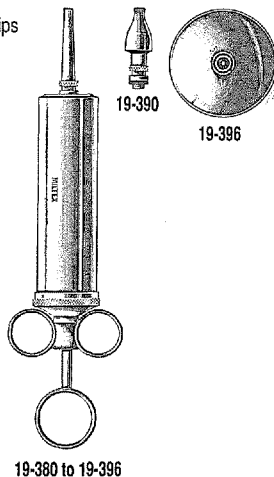

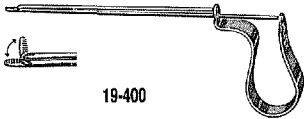

19-400

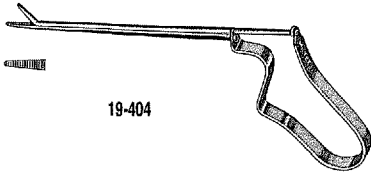

19-404

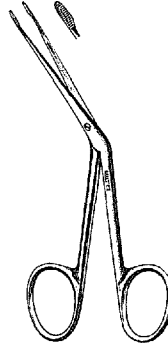

19-410

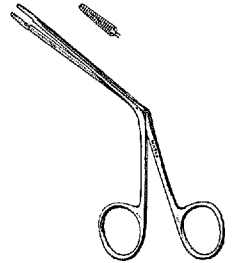

19-414

- 19-400** QUIRE Mechanical Finger 4" (10.2 cm), for removal of foreign bodies, spring handle
- 19-404** NOYES Alligator Forceps 4" (10.2 cm), spring handle
- 19-410** HARTMAN Ear Forceps 5" (12.7 cm), delicate serrated jaws 2.5 x 6 mm
- 19-414** LITTAUER Ear Forceps 4¾" (12.1 cm), delicate serrated jaws 2.5 x 8 m

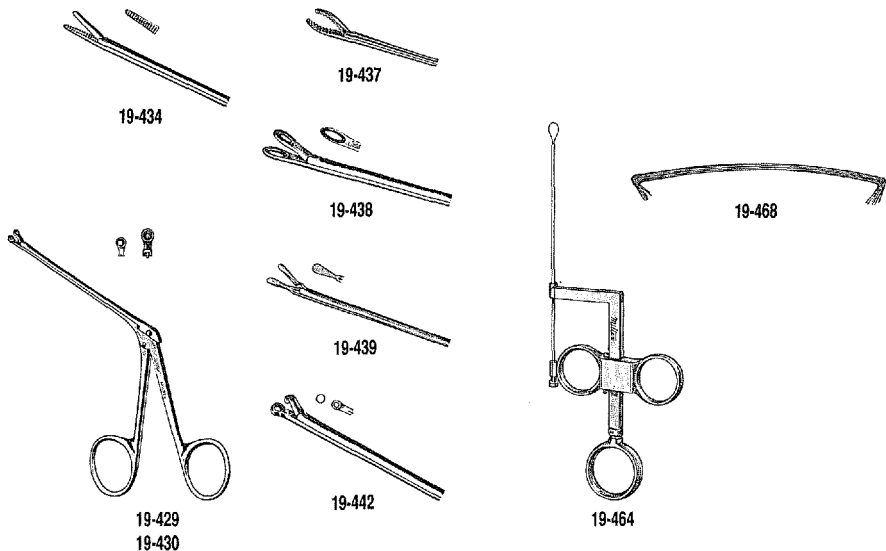

- 19-429 HARTMAN-HERZFELD Cup-Shape Forceps, alligator type, 3" (7.6 cm) shaft, 2 mm cup
- 19-430 HARTMAN-HERZFELD Cup-Shape Forceps, alligator type, 3" (7.6 cm) shaft, 3 mm cup
- 19-434 HARTMAN-NOYES Ear Forceps, alligator type, 3¼" (8.3 cm) shaft, serrated jaws
- 19-437 WEINGARTNER Ear Forceps, alligator type, 3" (7.6 cm) shaft, concave serrated jaws
- 19-438 STRUEMPEL Ear Forceps, alligator type, 3" (7.6 cm) shaft, fenestrated oval spoon jaws
- 19-439 Duckbill Ear Forceps, alligator type, 3" (7.6 cm) shaft, very flat serrated jaws, rounded tip
- 19-442 HOFFMAN Ear Forceps, alligator type, 3" (7.6 cm) shaft, through cutting round jaws
- 19-464 BRUENING Ear Snare, bayonet shape, 2½" (6.4 cm), cannula, delicate pattern
- 19-465 Stylet only for Bruening Ear Snare
- 19-468 Cut Snare Wire, 3" (7.6 cm) long, fine size 1 for ear snares

For Snare Wire sizes 4 and 5 see page 294
For Snare Wire sizes 6,7,8 and 9 see page 361



19-500

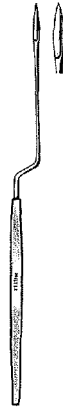

19-502



19-504



19-510

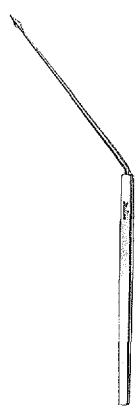

19-512

- 19-500 SEXTON Ear Knife 7" (17.8 cm), straight
- 19-502 SEXTON Ear Knife 7" (17.8 cm), bayonet
- 19-504 SEXTON Ear Knife 7" (17.8 cm), angled
- 19-510 POLITZER Ear Knife 7" (17.8 cm), spear blade, bayonet
- 19-512 POLITZER Ear Knife 7" (17.8 cm), spear blade, angled
- 19-520 SEXTON Ear Knife 7½" (19.1 cm), in reversible swivel handle (use in straight or angled position)
- 19-524 POLITZER Ear Knife 7½" (19.1 cm), in reversible swivel handle (use in straight or angled position)

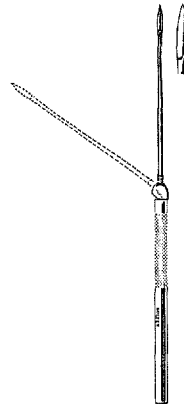

19-520



19-524

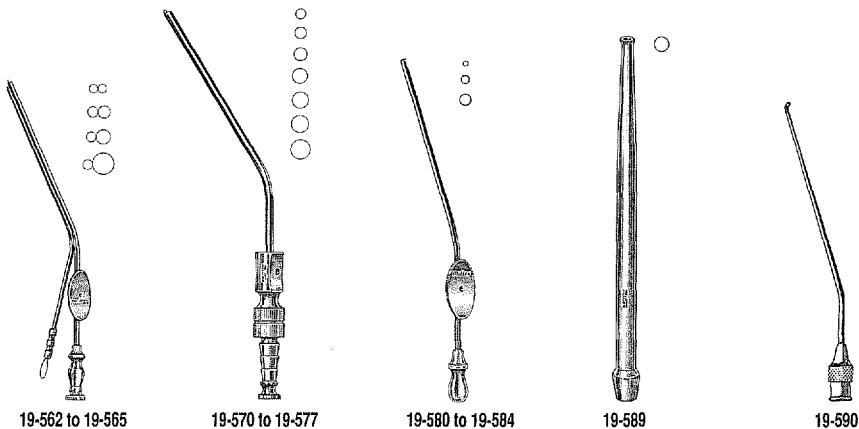

HOUSE SUCTION-IRRIGATION TUBES, 9 cm working length

- 19-562** 1.8 mm Suction Tube and 1.8 mm Irrigating Tube
- 19-563** 2.5 mm Suction Tube and 2 mm Irrigating Tube
- 19-564** 3 mm Suction Tube and 2 mm Irrigating Tube .
- 19-565** 4.5 mm Suction Tube and 2 mm Irrigating Tube

FRAZIER FERGUSON SUCTION TUBES, with finger cut-off, angled

- | | | | |
|---------------|-------------------|---------------|--------------------|
| 19-570 | 6 French (2 mm) | 19-575 | 10 French (3.3 mm) |
| 19-572 | 7 French (2.3 mm) | 19-576 | 11 French (3.6 mm) |
| 19-573 | 8 French (2.6 mm) | 19-577 | 12 French (4 mm) |
| 19-574 | 9 French (3 mm) | | |

- 19-580** BARON Suction Tube, 3 French (1 mm) with finger cut-off, 7.5 cm tube
- 19-582** BARON Suction Tube, 5 French (1.7 mm) with finger cut-off, 7.5 cm tube
- 19-584** BARON Suction Tube, 7 French (2.3 mm) with finger cut-off, 7.5 cm tube
- 19-589** ANTHONY Suction Tube 6½" (16.5 cm), with 3 mm lumen
- 19-590** DAY Attic Cannula, 3" (7.6 cm) to bend, very delicate, tapered, with Luer Lock connection, silver

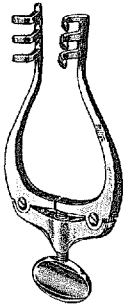

11-2

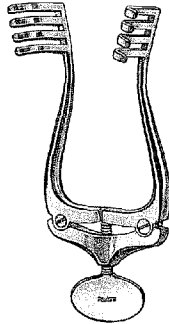

11-4

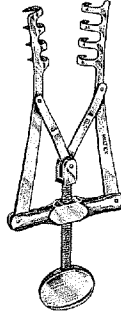

11-6

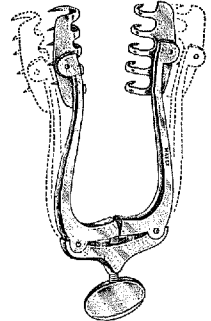

11-8

- 11-2 JANSEN Mastoid Retractor 4¼" (10.8 cm), spread 3" (7.6 cm), 3 x 3 blunt prongs
10 mm deep, standard model
- 11-4 JANSEN Mastoid Retractor 4½" (11.4 cm), spread 3" (7.6 cm), 4 x 4 blunt prongs
20 mm deep
- 11-6 ALLPORT Mastoid Retractor 4" (10.2 cm), spread 2½" (6.4 cm), 4 x 4 sharp prongs
- 11-8 JANSEN-WAGNER Mastoid Retractor 5" (12.7 cm), 5 x 5 sharp prongs, self-adjusting

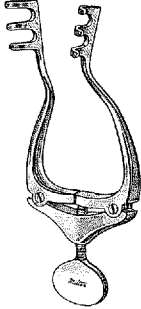

11-10

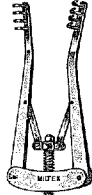

11-12
11-13

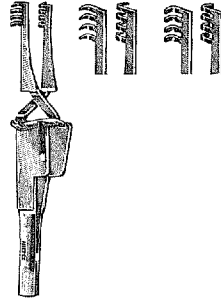

11-14
11-16

- 11-10 DAVIS Retractor 4½" (11.4 cm), 3 x 3 blunt prongs
- 11-12 ALM Retractor 2¾" (7 cm), spread 2¼" (5.7 cm), prongs ⅛" (.32 cm) deep
- 11-13 ALM Retractor 3⅞" (9.8 cm), spread 3" (7.6 cm), prongs ½" (1.3 cm) deep
- 11-14 MILTEX Cross Action Retractor 4" (10.2 cm), sharp prongs
- 11-16 MILTEX Cross Action Retractor 4" (10.2 cm), blunt prongs

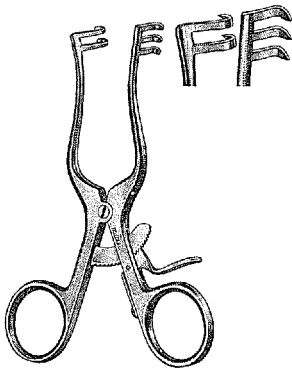

11-600 to 11-602'

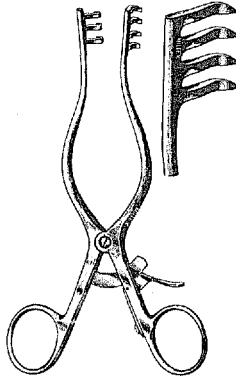

11-608 to 11-616

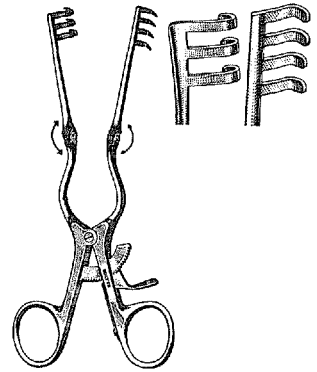

11-630 to 11-634

WEITLANER RETRACTORS

Sharp

11-600 4" (10.2 cm), 2 x 3 teeth

11-608 5½" (14 cm), 3 x 4 teeth

11-614 6½" (16.5 cm), 3 x 4 teeth

Blunt

11-602

11-610

11-616

BECKMAN-WEITLANER RETRACTORS, with hinged blades

Sharp

11-630-SH 5½" (14 cm), 3 x 4 teeth

11-634-SH 6½" (16.5 cm), 3 x 4 teeth

Blunt

11-630-BL

11-634-BL

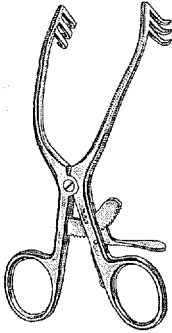

19-655

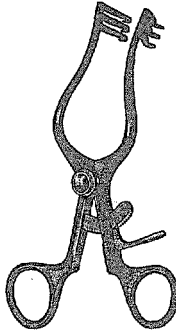

19-660

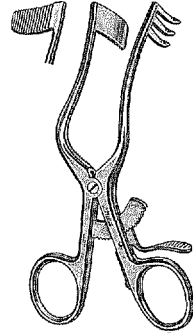

19-668
19-669

- 19-655 SCHUHKNECHT Postauricular Retractor 5" (12.7 cm), 3 x 3 sharp teeth 3" (7.6 cm) opening
- 19-660 WULLSTEIN Endaural Retractor 5" (12.7 cm), 3 x 3 sharp teeth, ebony non-glare finish
- 19-668 PERKINS Endaural Retractor 5¼" (13.3 cm), left serrated solid blade, right side 3 teeth
- 19-669 PERKINS Endaural Retractor 5¼" (13.3 cm), right serrated solid blade, left side 3 teeth

Ear Instruments

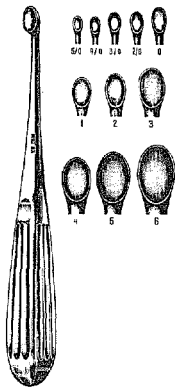

19-700 to 19-720



19-750 to 19-760



19-770 to 19-780



19-784
19-785



19-790

- | | | | | |
|--------|---|--------|--------|--|
| | SPRATT (BRUN) MASTOID CURETTES 6½" (16.5 cm), oval pups | | | |
| 19-700 | Size 5/0 | 19-712 | Size 2 | |
| 19-702 | Size 4/0 | 19-714 | Size 3 | |
| 19-704 | Size 3/0 | 19-716 | Size 4 | |
| 19-706 | Size 2/0 | 19-718 | Size 5 | |
| 19-708 | Size 0 | 19-720 | Size 6 | |
| 19-710 | Size 1 | | | |
| 19-750 | ALEXANDER Mastoid Chisel 7" (17.8 cm), width 4 mm | | | |
| 19-752 | ALEXANDER Mastoid Chisel 7" (17.8 cm), width 6 mm | | | |
| 19-754 | ALEXANDER Mastoid Chisel 7" (17.8 cm), width 8 mm | | | |
| 19-756 | ALEXANDER Mastoid Chisel 7" (17.8 cm), width 10 mm | | | |
| 19-758 | ALEXANDER Mastoid Chisel 7" (17.8 cm), width 12 mm | | | |
| 19-760 | ALEXANDER Mastoid Chisel 7" (17.8 cm), width 14 mm | | | |
| 19-770 | ALEXANDER Mastoid Gouge 7" (17.8 cm), width 4 mm | | | |
| 19-772 | ALEXANDER Mastoid Gouge 7" (17.8 cm), width 6 mm | | | |
| 19-774 | ALEXANDER Mastoid Gouge 7" (17.8 cm), width 8 mm | | | |
| 19-776 | ALEXANDER Mastoid Gouge 7" (17.8 cm), width 10 mm | | | |
| 19-780 | ALEXANDER Mastoid Gouge 7" (17.8 cm), width 14 mm | | | |
| 19-784 | BISHOP Mastoid Gouge 6¾" (17.1 cm), width 3 mm | | | |
| 19-785 | BISHOP Mastoid Gouge 6¾" (17.1 cm), width 4 mm | | | |
| 19-790 | GERZOG Mallet 7½" (19.1 cm), head 8 oz. (227 g) lead filled with stainless jacket | | | |
| 19-792 | LUCAE Mallet 7¾" (19.7 cm), head 9 oz. (255 g) solid stainless | | | |

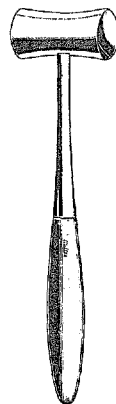

19-792

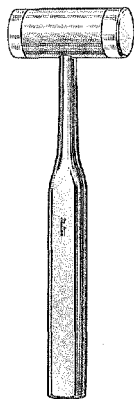

19-793
19-794

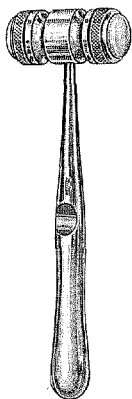

19-796

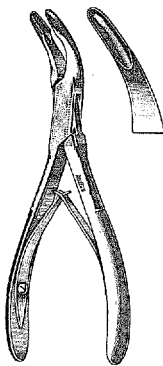

19-804

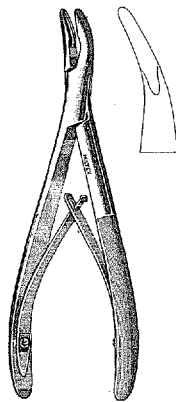

19-808

- 19-793 MILTEX Mallet 7½" (19.1 cm), lightweight 7.5 oz. (213 g), stainless head 1" (2.5 cm) dia. with 2 replaceable nylon caps
- 19-794 MILTEX Mallet 7½" (19.1 cm), lightweight 9 oz. (255 g), stainless head 1" (2.5 cm) dia. with one stainless face and one replaceable nylon cap
- 19-795 Nylon Cap Replacement for Nos. 19-793 and 19-794 Mallets
- 19-796 MEAD MALLET 7½" (19.1 cm), head 8 oz. (227 g), with 2 replaceable nylon caps
- 19-797 Nylon Cap Replacement for No. 19-796 Mallet
- 19-804 HARTMAN Mastoid Rongeur 5¾" (14.6 cm), strong curve
- 19-808 BANE Mastoid Rongeur 7" (17.8 cm), curved
- 18-1990 KERRISON Rongeur 3" (7.6 cm) shaft, size 0, 3.5 mm bite
- 18-1992 KERRISON Rongeur 3" (7.6 cm) shaft, size 1, 4 mm bite
- 18-1994 KERRISON Rongeur 3" (7.6 cm) shaft, size 2, 4.5 mm bite
- 18-1996 KERRISON Rongeur 3" (7.6 cm) shaft, size 3, 5 mm bite

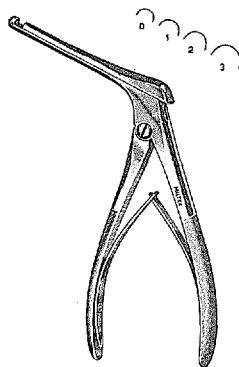

18-1990 to 18-1996

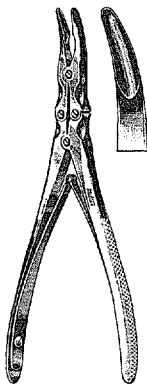

19-840

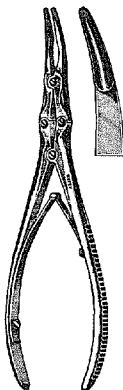

19-844

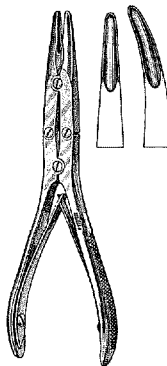

19-848
19-849

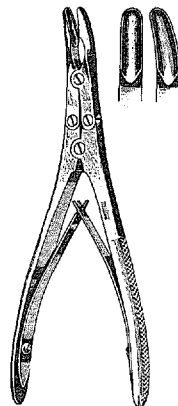

19-850 to 19-856

19-840 ZAUDEL-JANSEN Rongeur 7" (17.8 cm), double action, slightly curved jaws 5 mm wide

19-844 BEYER Rongeur 7" (17.8 cm), double action, slightly curved jaws 3.5 mm wide

RUSKIN RONGEURS, double action

Straight Jaws

- 19-848** 6" (15.2 cm) long, 3 mm bite
- 19-850** 7¼" (18.4 cm) long, 5 mm bite
- 19-854** 7¼" (18.4 cm) long, 7 mm bite

Curved Jaws

- 19-849**
- 19-852**
- 19-856**

19-1230 LEMPERS Rongeur 6¼" (15.9 cm), straight, delicate, 2.5 mm bite

19-1232 LEMPERS Rongeur 6¼" (15.9 cm), curved, delicate, 2.5 mm bite

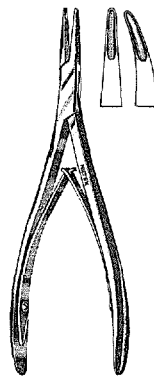

19-1230
19-1232

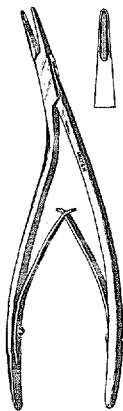

19-1234

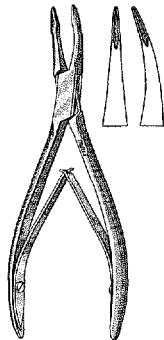

17-4800
17-4801



19-1330



19-1334
19-1336



19-1340

- 19-1234 JUERS-LEMPERT Rongeur 7 1/4" (18.4 cm), straight jaws on curved handles, delicate, 2.5 mm bite
- 17-4800 Micro Friedman Rongeur 5 1/2" (14 cm), straight 1.3 mm wide jaws, very delicate
- 17-4801 Micro Friedman Rongeur 5 1/2" (14 cm), curved 1.3 mm wide jaws, very delicate
- 19-1330 LEMPERT Elevator 7 1/4" (18.4 cm), straight 2 mm blade, light pattern
- 19-1334 LEMPERT Elevator 7 1/4" (18.4 cm), curved 2 mm blade, light pattern
- 19-1336 LEMPERT Elevator 7 1/4" (18.4 cm), curved 3 mm blade, light pattern
- 19-1340 LEMPERT Elevator 7 1/4" (18.4 cm), curved 4 mm blade, heavy pattern
- 19-1350 LEMPERT Endaural Curette 8 1/4" (21 cm), oval cup size 5/0
- 19-1352 LEMPERT Endaural Curette 8 1/4" (21 cm), oval cup size 4/0
- 19-1354 LEMPERT Endaural Curette 8 1/4" (21 cm), oval cup size 3/0
- 19-1356 LEMPERT Endaural Curette 8 1/4" (21 cm), oval cup size 2/0
- 19-1820 Ear Suction Tube, with 2 interchangeable tips 20 ga. and 22 ga.



19-1350 to 19-1356

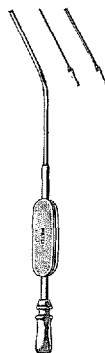

19-1820

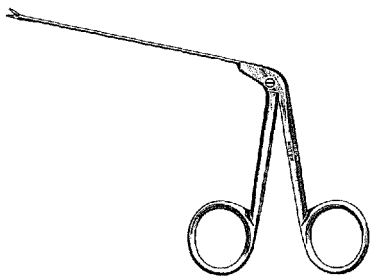

19-2060

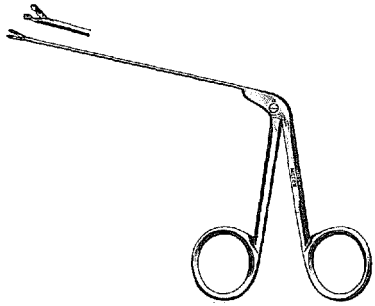

19-2120
19-2130

- 19-2060 WULLSTEIN Ear Scissors, 3" (7.6 cm) shaft, straight, very delicate
- 19-2120 WULLSTEIN Ear Forceps 3" (7.6 cm) shaft, oval cup jaws 1 mm wide
- 19-2130 WULLSTEIN Ear Forceps 3" (7.6 cm) shaft, round cup jaws 1 mm dia.
- 19-2081-B Micro Alligator Ear Forceps 3/4" (8.3 cm) shaft, serrated jaws 0.6 mm wide, ebony finish
- 19-2100 Micro Alligator Ear Forceps, 3/4" (8.3 cm) shaft, serrated jaws 0.8 mm wide
- 19-2100-B Micro Alligator Ear Forceps, 3/4" (8.3 cm) shaft, serrated jaws 0.8 mm wide, ebony finish
- 19-2090-B Micro Alligator Ear Forceps, 3/4" (8.3 cm) shaft, oval cup jaws 0.5 mm wide, ebony finish
- 19-2110 Micro Alligator Ear Forceps, 3/4" (8.3 cm) shaft, oval cup jaws 0.8 mm wide
- 19-2110-B Micro Alligator Ear Forceps, 3/4" (8.3 cm) shaft, oval cup jaws 0.8 mm wide, ebony finish
- 19-2138 HOUSE Strut Forceps, 2 3/4" (7 cm) shaft, smooth jaws 0.8 mm wide
- 19-2150-B BELLUCCI Micro Ear Scissors, 2 3/4" (7 cm) shaft, 4 mm blades, ebony finish



19-2081-B



19-2100

19-2138

19-2100-B



19-2090-B



19-2110

19-2110-B



19-2150-B

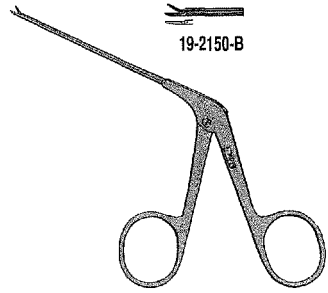

19-2081-B to 19-2150-B

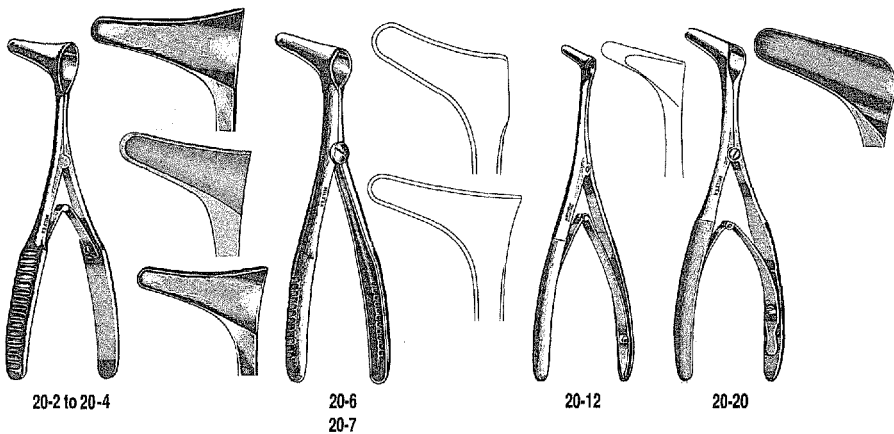

- 20-2 VIENNA Nasal Speculum 5¾" (14.6 cm), standard pattern, large size
- 20-3 VIENNA Nasal Speculum 5¾" (14.6 cm), standard pattern, medium size
- 20-4 VIENNA Nasal Speculum 5¾" (14.6 cm), standard pattern, small size
- 20-6 VIENNA Lightweight Nasal Speculum 5¾" (14.6 cm), adult size
- 20-7 VIENNA Lightweight Nasal Speculum 5¾" (14.6 cm), child size
- 20-12 TIECK (HALLE) Infant Nasal Speculum 5¾" (14 cm)
- 20-20 SONNENSCHNEIN Nasal Speculum 6" (15.2 cm)
- 20-24 BECKMAN Nasal Speculum 6" (15.2 cm), angled on side

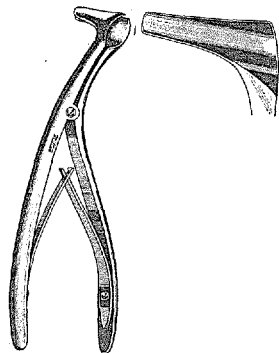

20-24

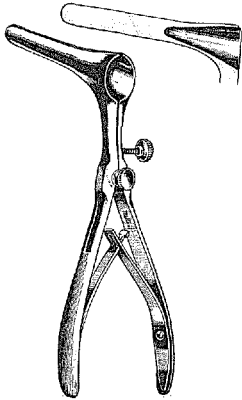

20-28 to 20-32

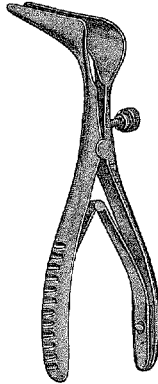

20-36-35 to 20-36-90

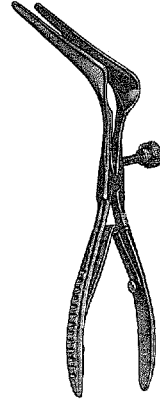

20-37-45 to 20-37-75

- 20-28** KILLIAN Septum Speculum 6" (15.2 cm), with set screw, 2" (5.1 cm) long blades
- 20-29** KILLIAN Septum Speculum 6" (15.2 cm), with set screw, 2½" (6.4 cm) long blades
- 20-30** KILLIAN Septum Speculum 6" (15.2 cm), with set screw, 3" (7.6 cm) long blades
- 20-32** KILLIAN Septum Speculum 6" (15.2 cm), with set screw, 3½" (8.9 cm) long blades

- 20-36-35** COTTLE Septum Speculum 6" (15.2 cm), with set screw, narrow 35 mm long blades, ebony finish
- 20-36-50** COTTLE Septum Speculum 6" (15.2 cm), with set screw, narrow 50 mm long blades, ebony finish
- 20-36-75** COTTLE Septum Speculum 6" (15.2 cm), with set screw, narrow 75 mm long blades, ebony finish
- 20-36-90** COTTLE Septum Speculum 6" (15.2 cm), with set screw, narrow 90 mm long blades, ebony finish
- 20-37-45** COTTLE Septum Speculum 5½" (14 cm), with set screw, extra delicate, very thin 45 mm long blades, ebony finish
- 20-37-75** COTTLE Septum Speculum 5½" (14 cm), with set screw, extra delicate, very thin 75 mm long blades, ebony finish

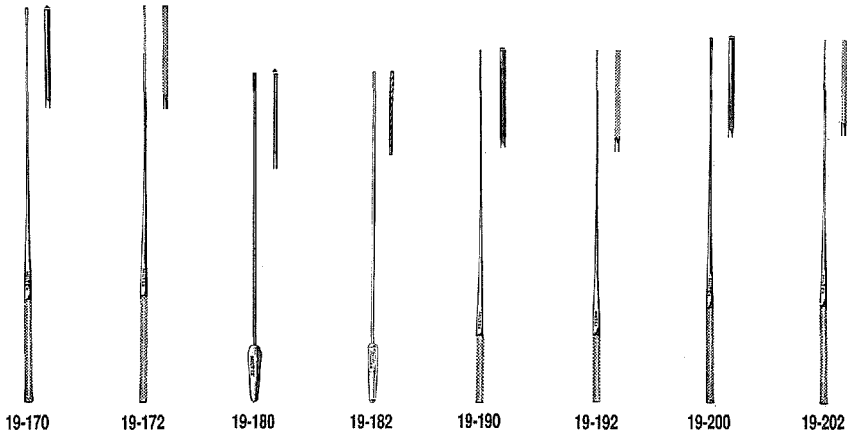

- 19-170 UEBE Applicator 7" (17.8 cm), triangular tip
- 19-172 UEBE Applicator 7" (17.8 cm), cross serrated tip
- 19-180 BROWN Applicator 6" (15.2 cm), triangular tip, copper
- 19-182 BROWN Applicator 6" (15.2 cm), cross serrated tip, copper
- 19-190 LATHBURY Applicator 5½" (14 cm), triangular tip
- 19-192 LATHBURY Applicator 5½" (14 cm), cross serrated tip
- 19-200 FARRELL Applicator 6½" (16.5 cm), triangular tip
- 19-202 FARRELL Applicator 6½" (16.5 cm), cross serrated tip
- 20-100 THEOBALD (FISH) Sinus Probe 6" (15.2 cm), sterling
- 20-102 SKILLERN Sinus Probe 6½" (16.5 cm), graduated, sterling
- 20-120 WILDE Nasal Dressing Forceps 6½" (16.5 cm), angular

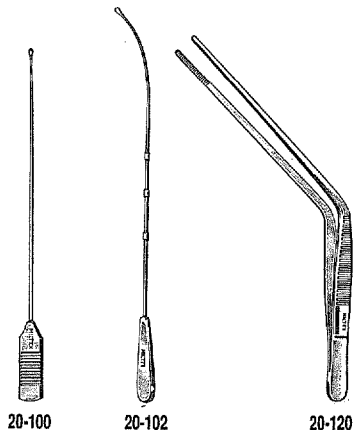



6-190



6-192



19-371



6-197
6-198

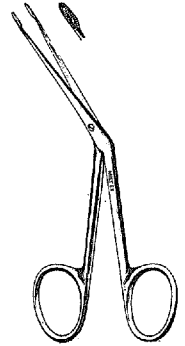

20-124

- 6-190 CUSHING Dressing Forceps 7¼" (18.4 cm), bayonet, serrated tips, scraper end
- 6-192 CUSHING Tissue Forceps 7¼" (18.4 cm), bayonet, 1 x 2 teeth, scraper end
- 19-371 JANSEN Bayonet Dressing Forceps 6¼" (15.9 cm), extra delicate with 2 mm wide serrated tips
- 6-197 JANSEN (GRUENWALD) Bayonet Dressing Forceps 6¼" (15.9 cm), serrated tips
- 6-198 ADSON Bayonet Dressing Forceps 8¼" (21 cm), serrated tips
- 20-124 HARTMAN Nasal Dressing Forceps 7" (17.8 cm), improved delicate pattern, serrated tips
- 20-126 HARTMAN Nasal Dressing Forceps 7¼" (18.4 cm), regular model, serrated tips
- 20-130 LITTAUER Nasal Dressing Forceps 6¾" (17.1 cm), slender mortised shanks, serrated tips

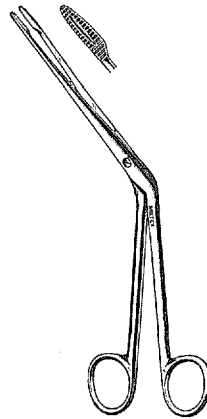

20-126

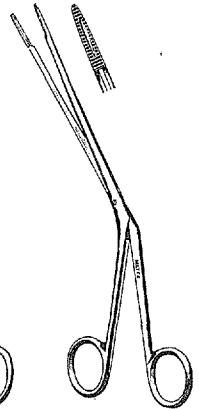

20-130

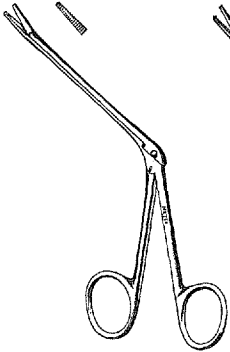

20-140
20-142

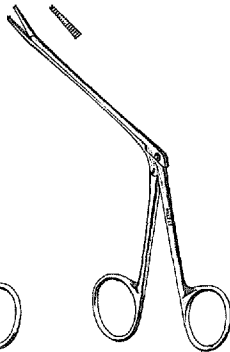

20-144

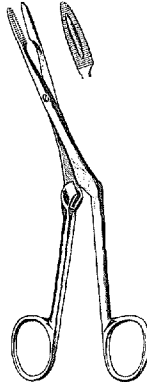

20-148

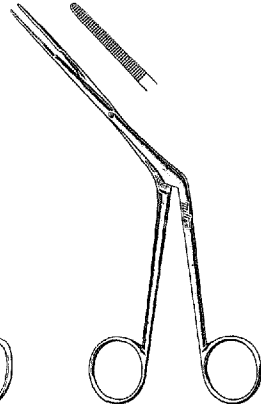

20-150

- 20-140 NOYES Alligator Forceps 5½" (14 cm) shaft, serrated jaws
- 20-142 NOYES Alligator Forceps 6½" (16.5 cm) shaft, serrated jaws
- 20-144 NOYES Alligator Forceps 5½" (14 cm) shaft, 1 x 2 teeth
- 20-148 KNIGHT Nasal Forceps 6¾" (17.1 cm), standard pattern, serrated tips
- 20-150 MUSEHOLDT Nasal Dressing Forceps 7" (17.8 cm), slender long serrated blades

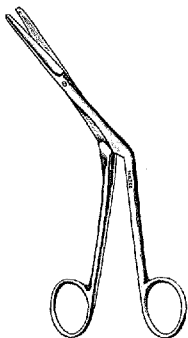

20-160

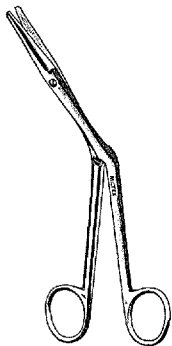

20-164

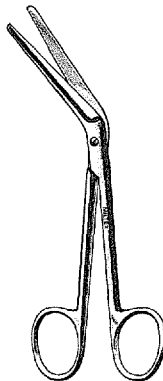

20-168

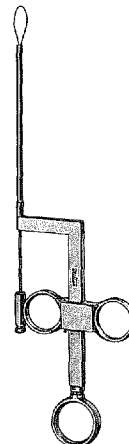

20-177

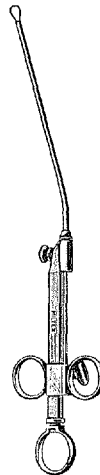

20-180

- 20-160 KNIGHT Nasal Scissors 6¾" (17.1 cm), angled on side, standard pattern
- 20-164 HEYMAN Nasal Scissors 6¾" (17.1 cm), angled on side, rounded blades
- 20-168 SEILER Turbinate Scissors 6¼" (15.9 cm), angled on side
- 20-177 BRUENING Nasal Snare 9" (22.9 cm), bayonet shape for unobstructed view
- 20-178 Stylet only for Bruening Snare
- 20-180 KRAUSE Nasal Snare 10" (25.4 cm), standard pattern with slightly angled cannula
- 20-182 Stylet only for Krause Snare
- 20-184 Cannula only for Krause Snare
- 20-186-4* Cut Snare Wire, 4" (10.2 cm) long with formed ends, size 4, for nasal snares
- 20-186-5* Cut Snare Wire, 4" (10.2 cm) long with formed ends, size 5, for nasal snares



20-186

*For Snare Wire size 1 see page 277

*For Snare Wire sizes 6, 7, 8 and 9 see page 361

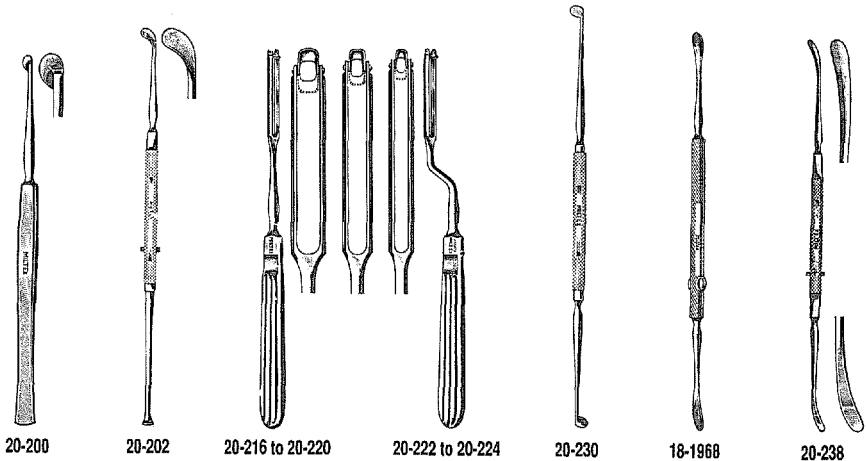

- 20-200** FREER Septum Knife 6¼" (15.9 cm), "D" model blade
20-202 FREER Submucous Knife 7½" (19.1 cm), angled blade

BALLENGER SWIVEL KNIVES 7¼" (19.7 cm)

Straight	Width	Bayonet
20-216	3 mm	20-222
20-218	4 mm	20-224
20-220	5 mm	—

- 20-230** PIERCE Double End Elevator 8½" (21.6 cm), with right and left blades
18-1968 FREER Elevator 7" (17.8 cm), double end sharp and blunt blades 5 mm wide
20-238 ROGER Septum Elevator 7¼" (19.7 cm), double ended with curved semi-sharp and blunt blades



20-242



20-246



20-258



20-270

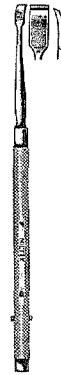

18-1960



20-274



20-278 to 20-284

- 20-242** DUNNING Elevator and Curette 8¼" (21 cm), blunt elevator and sharp small oval curette
- 20-246** PENNINGTON Septum Elevator 8¼" (21 cm), double end for right and left side
- 20-258** HAJEK-BALLENGER Septum Elevator 7¼" (18.4 cm), double end straight semi-sharp and blunt blades
- 20-270** FREER Submucous Chisel 6½" (16.5 cm), straight, 4 mm wide
- 18-1960** FREER Submucous Chisel 6½" (16.5 cm), curved, 4 mm wide
- 20-274** FREER Septum Gouge 6¼" (15.9 cm), straight, 6 mm wide
- 20-278** BALLENGER V-Shaped Chisel 6¼" (15.9 cm), 2 mm wide
- 20-280** BALLENGER V-Shaped Chisel 6¼" (15.9 cm), 4 mm wide
- 20-282** BALLENGER V-Shaped Chisel 6¼" (15.9 cm), 6 mm wide
- 20-284** BALLENGER V-Shaped Chisel 6¼" (15.9 cm), 8 mm wide

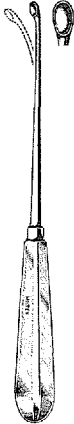

20-300

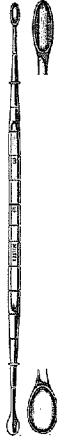

20-308

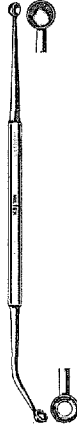

20-312

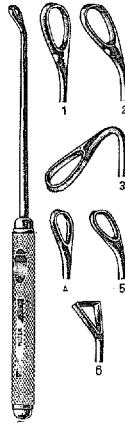

20-330 to 20-342



20-360

20-300 HALLE Ethmoid Curette 8½" (21.6 cm), stainless oval cup on malleable copper shaft

20-308 MOSHER Ethmoid Curette 8¾" (22.2 cm), double end oval cups, shaft graduated in ½ inches (1.3 cm)

20-312 PRATT Ethmoid Curette 8¾" (21.6 cm), double end, fenestrated cup on angled shaft and solid cup on straight shaft

COAKLEY ANTRUM CURETTES 6¾" (17.1 cm)

20-330 Set of 6, Nos. 1 through 6

20-332 No. 1 Large Size 30° angle

20-334 No. 2 Large Size 60° angle

20-336 No. 3 Large Size 100° angle

20-338 No. 4 Small Size 30° angle

20-340 No. 5 Small Size 60° angle

20-342 No. 6 Triangle 30° angle

20-360 FAULKNER Ethmoid Curette 9" (22.9 cm), double end 7 mm and 10 mm rings, sharp on both sides

20-378 WIENER Antrum Rasp 8" (20.3 cm), No. 1 small with trocar tip

20-380 WIENER Antrum Rasp 8" (20.3 cm), No. 2 medium with trocar tip

20-382 WIENER Antrum Rasp 8" (20.3 cm), No. 3 large with trocar tip

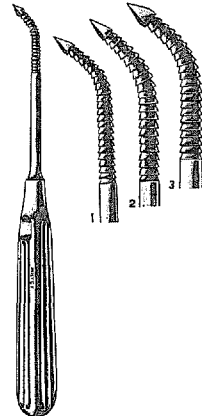

20-378 to 20-382

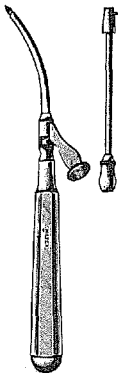

20-400



20-404



20-420



20-424



20-428

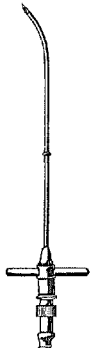

20-430

- 20-400 COAKLEY Antrum Trocar 7" (17.8 cm), standard curve with 3 mm dia. cannula and irrigating extension
- 20-404 PIERCE Antrum Trocar 7" (17.8 cm), with 5 mm dia. cannula and tubing connection
- 20-420 LIGHTWICZ Antrum Trocar Needle 4½" (11.4 cm), 16 gauge with beveled stylet and crossbar, Luer lock
- 20-424 VAN ALYEA Antrum Cannula 4½" (11.4 cm), trocar tip 1.8 mm, Luer lock
- 20-428 RUSKIN Antrum Trocar Needle 4" (10.2 cm), straight, 16 gauge with cross bar and tubing connection, Luer lock
- 20-430 RUSKIN Antrum Trocar Needle, 4" (10.2 cm), curved, 16 gauge with cross bar and tubing connection, Luer lock
- 20-436 VAN ALYEA Frontal Sinus Cannula 6½" (16.5 cm), light curve, with tubing connection, Luer lock, sterling
- 20-438 VAN ALYEA Frontal Sinus Cannula 6½" (16.5 cm), strong curve, with tubing connection, Luer lock, sterling



20-436

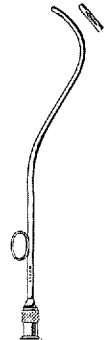

20-438



Nasal Instruments



20-440

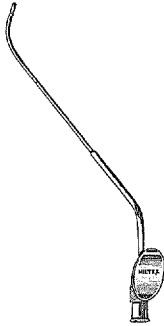

20-442



20-450



20-456



20-460

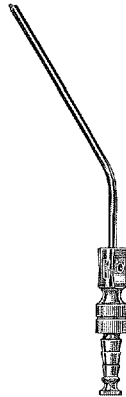

19-574

- 20-440 VAN ALYEA Antrum Cannula 4½" (11.4 cm), long curve, blunt tip, 1.8 mm, Luer lock
- 20-442 VAN ALYEA Frontal Cannula 4½" (11.4 cm), short curve, blunt tip, 1.8 mm, Luer lock
- 20-450 BOWER Sphenoid and Antrum Cannula 6½" (16.5 cm), dia. at tip 2 mm, lateral opening, Luer lock
- 20-456 KILLIAN (VON EICKEN) Antrum Cannula 5¾" (14.6 cm), dia. 2.5 mm, bulbous tip, center opening, sterling
- 20-460 FRAZIER FERGUSON Suction Tube 9 Fr. (3 mm) straight, with finger cut-off
- 19-574 FRAZIER FERGUSON Suction Tube 9 Fr. (3 mm) angled, with finger cut-off
- 20-466 COUPLAND Suction Tube 10" (25.4 cm), with 2 interchangeable tips 1.5 and 2 mm, chrome
- 10-220 ANTHONY Suction Tube 10" (25.4 cm), lumen 2 mm, chrome

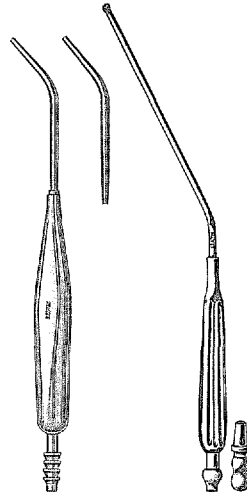

20-466

10-220

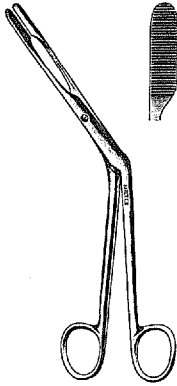

20-500

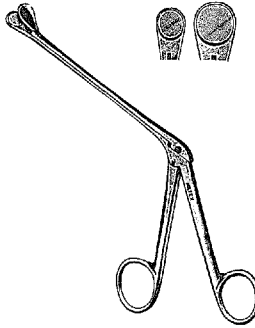

20-504
20-506

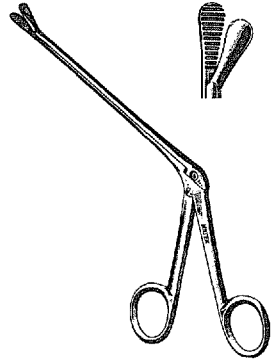

20-510

- 20-500 KILLIAN Septum Forceps 6¾" (17.1 cm), flat serrated jaws
25 x 5.5 mm, shaft 3¼" (8.3 cm)
- 20-504 WATSON-WILLIAMS Polyp Forceps 7¾" (19.7 cm), small
jaws 6 mm wide, shaft 4½" (10.8 cm)
- 20-506 WATSON-WILLIAMS Polyp Forceps 7¾" (19.7 cm), large
jaws 9 mm wide, shaft 4½" (10.8 cm)
- 20-510 LEWIS Septum Forceps 8" (20.3 cm), flat serrated jaws,
15 x 7 mm, shaft 4¾" (12.1 cm)
- 20-522 KNIGHT Septum Forceps 6¾" (17.1 cm), cup jaws
15 x 5 mm, shaft 3¼" (8.3 cm)

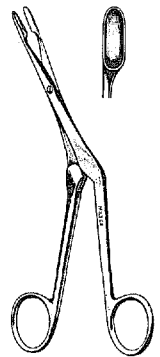

20-522



Nasal Instruments

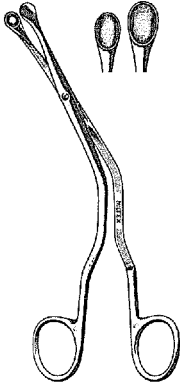

20-530
20-532

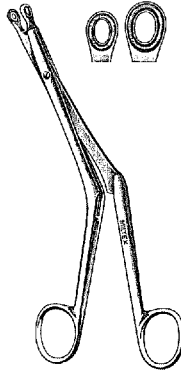

20-544
20-546

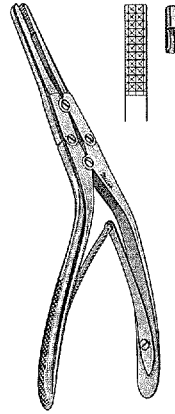

20-552
20-553

- 20-530 LUC Septum Forceps 7¾" (19.7 cm), cup jaws 9 x 5.5 mm
- 20-532 LUC Septum Forceps 7¾" (19.7 cm), cup jaws 11 x 6.5 mm
- 20-544 BRUENING Septum Forceps 7½" (19.1 cm), mortised shanks, small fenestrated cup jaws 7 mm wide
- 20-546 BRUENING Septum Forceps 7½" (19.1 cm), mortised shanks, large fenestrated cup jaws 8 mm wide
- 20-552 RUBIN Septal Morselizer 8" (20.3 cm), double action, deeply serrated jaws 17 x 5 mm, supplied with one slip-on guard
- 20-553 Slip-on guard only

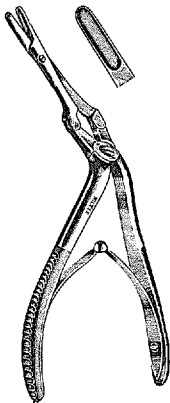

20-554

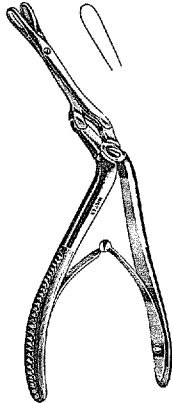

20-556

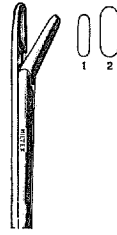

20-570
20-572

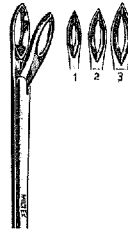

20-580 to 20-584

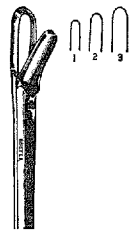

20-594 to 20-598

- 20-554** JANSEN-MIDDLETON Septum Forceps 7½" (19.1-cm), spoon-shaped cups 15 x 5 mm
- 20-556** JANSEN-MIDDLETON Septum Forceps 7½" (19.1 cm), through-cutting 19 x 4 mm
- 20-570** TAKAHASHI Ethmoid Forceps, 4½" (11.4 cm) shaft, 2.5 x 10 mm bite
- 20-572** TAKAHASHI Ethmoid Forceps, 4½" (11.4 cm) shaft, 4 x 10 mm bite
- 20-580** WILDE (BLAKESLEY) Ethmoid Forceps 5" (12.7 cm) shaft, pointed fenestrated cups 3 x 11 mm
- 20-582** WILDE (BLAKESLEY) Ethmoid Forceps 5" (12.7 cm) shaft, pointed fenestrated cups 4 x 12 mm
- 20-584** WILDE (BLAKESLEY) Ethmoid Forceps 5" (12.7 cm) shaft, pointed fenestrated cups 5 x 13 mm
- 20-594** GRUENWALD Nasal Forceps, 4½" (11.4 cm) shaft, through-cutting 2 x 10 mm bite
- 20-596** GRUENWALD Nasal Forceps, 4½" (11.4 cm) shaft, through-cutting 2.5 x 12 mm bite
- 20-598** GRUENWALD Nasal Forceps, 4½" (11.4 cm) shaft, through-cutting 3 x 12 mm bite
- 20-630** STRUYKEN Turbinate Forceps, 4½" (11.4 cm) shaft, through-cutting 1 x 15 mm bite

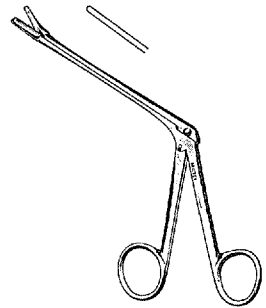

20-630

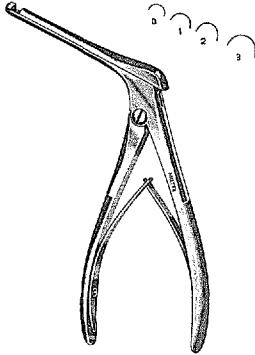

18-1990 to 18-1996

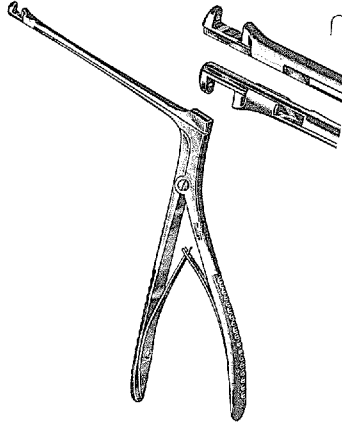

20-660
20-662

- 18-1990 KERRISON Rongeur, 3" (7.6 cm) shaft, size 0, 3.5 mm bite
- 18-1992 KERRISON Rongeur, 3" (7.6 cm) shaft, size 1, 4 mm bite
- 18-1994 KERRISON Rongeur, 3" (7.6 cm) shaft, size 2, 4.5 mm bite
- 18-1996 KERRISON Rongeur, 3" (7.6 cm) shaft, size 3, 5 mm bite

- 20-660 HAJEK Antrum Rongeur, 5" (12.7 cm) shaft, up-bite
- 20-662 HAJEK Antrum Rongeur, 5" (12.7 cm) shaft, down-bite

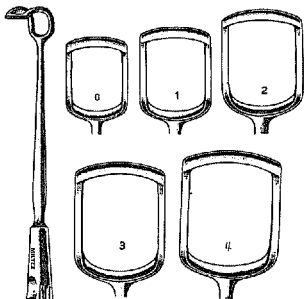

20-800 to 20-808



20-809

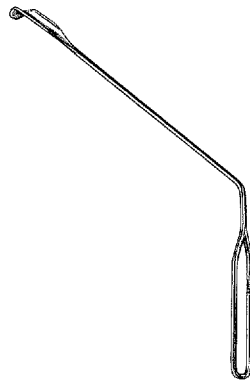

20-835

- 20-800 BARNHILL Adenoid Curette 8½" (21.6 cm), size 0, 11 mm blade
- 20-802 BARNHILL Adenoid Curette 8½" (21.6 cm), size 1, 13 mm blade
- 20-804 BARNHILL Adenoid Curette 8½" (21.6 cm), size 2, 15 mm blade
- 20-806 BARNHILL Adenoid Curette 8½" (21.6 cm), size 3, 17 mm blade
- 20-808 BARNHILL Adenoid Curette 8½" (21.6 cm), size 4, 19 mm blade
- 20-809 VOGEL Adenoid Curette 8½" (21.6 cm), infant size, 7 mm blade
- 20-835 LOTHROP Uvula Retractor 8" (20.3 cm) shaft, grooved blade
40 x 18 mm with 5 mm lip
- 20-836 LOVE Uvula Retractor, 18 mm wide blade
- 20-838 LOVE Uvula Retractor, 20 mm wide blade

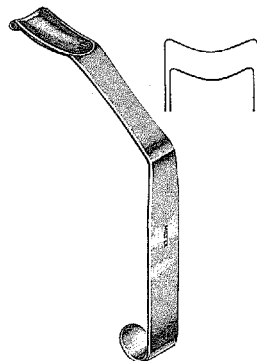

20-836
20-838



20-850 to 20-856

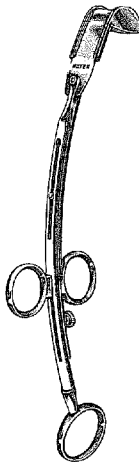

20-872 to 20-876



20-890

- 20-850** LAFORCE Adenotome 8½" (21.6 cm), infant size 0, cuts 7 mm width
20-852 LAFORCE Adenotome 9½" (24.1 cm), small size 1, cuts 11 mm width
20-854 LAFORCE Adenotome 9½" (24.1 cm), medium size 2, cuts 13 mm width
20-856 LAFORCE Adenotome 9½" (24.1 cm), large size 3, cuts 16 mm width
- 20-858-0** Blade 10 mm wide, solid, for size 0 LaForce Adenotome
20-858-1 Blade 13 mm wide, perforated, for size 1 LaForce Adenotome
20-858-2 Blade 16 mm wide, perforated, for size 2 LaForce Adenotome
20-858-3 Blade 19 mm wide, perforated, for size 3 LaForce Adenotome
- 20-872** SHAMBAUGH Adenotome 9½" (24.1 cm), reverse curve, small size 1, cuts 11 mm width
20-874 SHAMBAUGH Adenotome 9½" (24.1 cm), reverse curve, medium size 2, cuts 13 mm width
20-876 SHAMBAUGH Adenotome 9½" (24.1 cm), reverse curve, large size 3, cuts 15 mm width
- 20-878-1** Blade 13 mm wide, perforated, for size 1 Shambaugh Adenotome
20-878-2 Blade 16 mm wide, perforated, for size 2 Shambaugh Adenotome
20-878-3 Blade 19 mm wide, perforated, for size 3 Shambaugh Adenotome
- 20-890** YANKAUER Pharyngeal Speculum

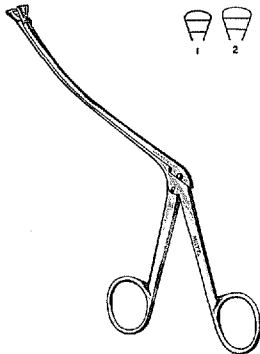

20-910
20-912

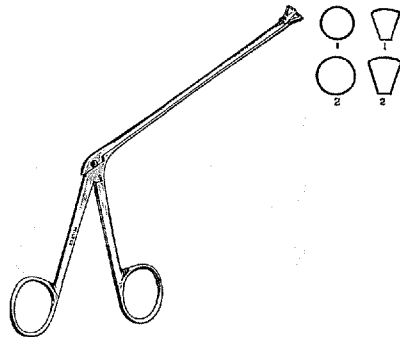

29-922 to 20-928

- 20-910 RONIS Adenoid Punch, 5" (12.7 cm) shaft curved upwards, small triangular jaws
- 20-912 RONIS Adenoid Punch, 5" (12.7 cm) shaft curved upwards, large triangular jaws
- 20-922 MELTZER Adenoid Punch 5" (12.7 cm) shaft, small round jaws with basket, size 1
- 20-924 MELTZER Adenoid Punch 5" (12.7 cm) shaft, large round jaws with basket, size 2
- 20-926 MELTZER Adenoid Punch 5" (12.7 cm) shaft, small triangular jaws with basket, size 1
- 20-928 MELTZER Adenoid Punch 5" (12.7 cm) shaft, large triangular jaws with basket, size 2

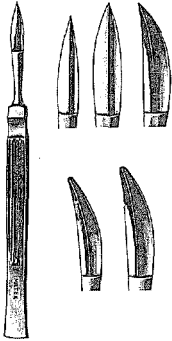

21-2 to 21-18



21-20



21-40



21-24



21-28



21-32

JOSEPH NASAL KNIVES 6" (15.2 cm), Double Edge

Pointed Tips

- 21-2 Small blade, straight
- 21-4 Large blade, straight
- 21-8 Large blade, curved

Blunt Tips

- 21-16 Small blade, curved
- 21-18 Large blade, curved

- 21-20 JOSEPH Button End Knife 6" (15.2 cm), straight blade 4 x 30 mm
- 21-40 JOSEPH Button End Knife 6¼" (15.9 cm), angled blade 4 x 12 mm
- 21-24 CONVERSE Bistouri 6" (15.2 cm), with button end, curved blade 4 x 35 mm
- 21-28 FOMON Knife 5½" (14 cm), double edge, blunt tip, curved
- 21-32 COTTLE Nasal Knife 5½" (14 cm), straight blade, 4 mm wide



18-1968



21-60



21-62
21-63



21-64

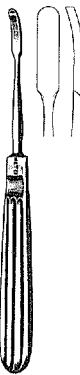

21-68



21-72



73-62

- 18-1968 FREER Septum Elevator 7" (17.8 cm), double end, sharp and blunt blades 5 mm wide
- 21-60 COTTLE Septum Elevator 9" (22.9 cm), double end, graduated in cm.
- 21-62 McKENTY Septum Elevator 5½" (14 cm), curved at tip, 4 mm wide
- 21-63 McKENTY Septum Elevator 5½" (14 cm), curved at tip, 5 mm wide
- 21-64 JOSEPH Periosteal Elevator 7" (17.8 cm), blade 6.5 mm wide, strong curve
- 21-68 FOMON Periosteal Elevator 6¼" (15.9 cm), slightly curved blade 4.5 mm wide, standard pattern
- 21-72 COTTLE Skin Elevator 7½" (19.1 cm), slightly curved blade 9 mm wide
- 73-62 MILTEX Periosteal Elevator 6" (15.2 cm), double end, slightly curved blade 6 mm wide and straight spear point rounded blade 3mm wide
- DELS23 SELDIN Periosteal Elevator 7¾" (19.7 cm), double end, slightly curved blades 10 mm and 13 mm wide



DELS23

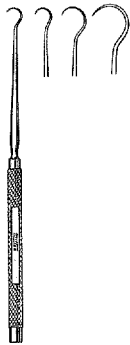

21-85 to 21-87



21-88
21-89



21-90 to 21-94



18-412
18-414



26-1084
26-1086



18-416



18-418



18-420

- 21-85 KLEINERT-KUTZ Hook 5" (12.7 cm), small size, 3 mm dia.
- 21-86 KLEINERT-KUTZ Hook 5" (12.7 cm), medium size, 5 mm dia.
- 21-87 KLEINERT-KUTZ Hook 5" (12.7 cm), large size, 7 mm dia.

- 21-88 GILLIES (CONVERSE) Skin Hook 7" (17.8 cm), large size
- 21-89 GILLIES (CONVERSE) Skin Hook 7" (17.8 cm), small size

- 21-90 COTTLE Skin Hook 5½" (14 cm), small, shallow curve
- 21-92 COTTLE Skin Hook 5½" (14 cm), small, deep curve
- 21-94 COTTLE Skin Hook 5½" (14 cm), large, deep curve

- 18-412 TYRELL (Iris) Hook 5" (12.7 cm), sharp
- 18-414 TYRELL (Iris) Hook 5" (12.7 cm), blunt

- 26-1084 FRAZIER Dura Hook 5" (12.7 cm), sharp point
- 26-1086 FRAZIER Dura Hook 5" (12.7 cm), blunt point

- 18-416 GUTHRIE (Iris) Hook 5" (12.7 cm), sharp double prongs 1.5 mm wide

- 18-418 WIENER Hook 5" (12.7 cm), sharp
- 18-420 WIENER Hook 5" (12.7 cm), blunt

- 18-428 NUGENT Hook 4¾" (12.1 cm), right angle, sharp

- 21-102 FREER Skin Hook 6" (15.2 cm), sharp double prongs 2.5 mm wide
- 21-103 FREER Skin Hook 6" (15.2 cm), blunt double prongs 2.5 mm wide

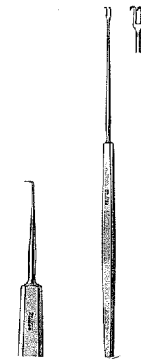

18-428

21-102
21-103

For additional Hooks see pages 188 - 194

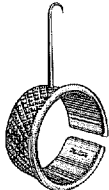

21-107

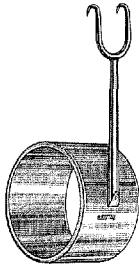

21-108



18-439



11D-27

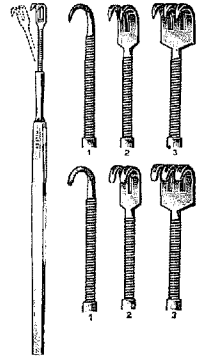

11-30 to 11-40

21-107 MILLARD Thimble Retractor, $\frac{5}{8}$ " (1.6 cm) working length, sharp single hook

21-108 COTTLE Thumb Retractor, $1\frac{1}{2}$ " (3.8 cm) working length, sharp double hook
8 mm wide

18-439 McGANNON Retractor 5" (12.7 cm), fenestrated blade 2.5 mm wide

11D-27 Flexible Neck Rake Retractor 5" (12.7 cm), 3 sharp prongs

11-30 Flexible Neck Rake Retractor 6" (15.2 cm), 1 sharp prong

11-32 Flexible Neck Rake Retractor 6" (15.2 cm), 2 sharp prongs

11-34 Flexible Neck Rake Retractor 6" (15.2 cm), 3 sharp prongs

11-36 Flexible Neck Rake Retractor 6" (15.2 cm), 1 blunt prong

11-38 Flexible Neck Rake Retractor 6" (15.2 cm), 2 blunt prongs

11-40 Flexible Neck Rake Retractor 6" (15.2 cm), 3 blunt prongs

11-50 Rigid Neck Rake Retractor 6" (15.2 cm), 1 sharp prong

11-52 Rigid Neck Rake Retractor 6" (15.2 cm), 2 sharp prongs

11-54 Rigid Neck Rake Retractor 6" (15.2 cm), 3 sharp prongs

11-56 Rigid Neck Rake Retractor 6" (15.2 cm), 1 blunt prong

11-58 Rigid Neck Rake Retractor 6" (15.2 cm), 2 blunt prongs

11-60 Rigid Neck Rake Retractor 6" (15.2 cm), 3 blunt prongs

18-100 KNAPP (ROLLET) Retractor $5\frac{1}{4}$ " (13.3 cm) with 4 sharp prongs

18-102 KNAPP Retractor $5\frac{1}{4}$ " (13.3 cm), with 4 blunt prongs

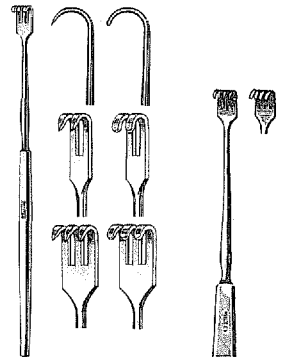

11-50 to 11-60

18-100

18-102

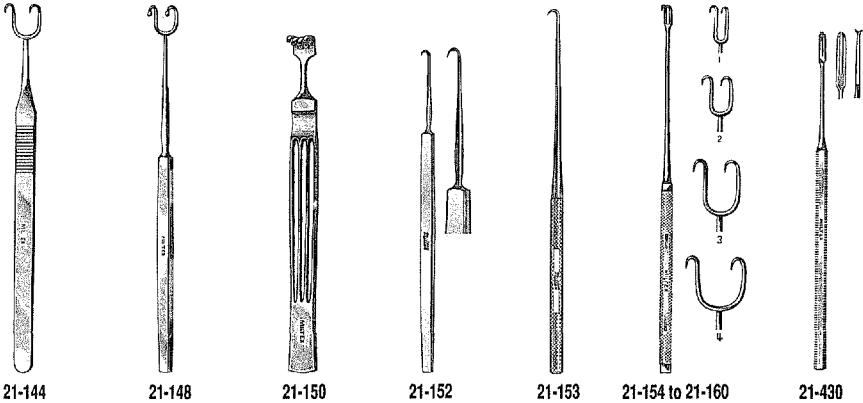

- 21-144 COTTLE Double Hook 5½" (14 cm), two sharp prongs 12 mm wide
- 21-148 FOMON Retractor 6½" (16.5 cm), two ball end prongs 11 mm wide
- 21-150 COTTLE Retractor 5½" (14 cm), four blunt prongs, 2 center prongs recessed
- 21-152 MILTEX Skin Hook 4¾" (12.1 cm), sharp prong 2 mm dia.
- 21-153 JOSEPH Single Hook 6¼" (15.9 cm), one sharp prong
- 21-154 JOSEPH Double Hook 6¼" (15.9 cm), two sharp prongs 2 mm
- 21-156 JOSEPH Double Hook 6¼" (15.9 cm), two sharp prongs 5 mm
- 21-158 JOSEPH Double Hook 6¼" (15.9 cm), two sharp prongs 7 mm
- 21-160 JOSEPH Double Hook 6¼" (15.9 cm), two sharp prongs 10 mm
- 21-430 MILTEX Tissue Twist Hook 5½" (14 cm)
- 30-950 MILTEX Tenaculum Hook 8" (20.3 cm), extra delicate pointed hook, handle graduated in cm
- 33-121 SELTZER Dermal Biopsy Hook 4½" (11.4 cm), sharp point
- 21-163 CONVERSE Alar Retractor 4" (10.2 cm), double end, with blunt double hooks 10 mm and 14 mm wide

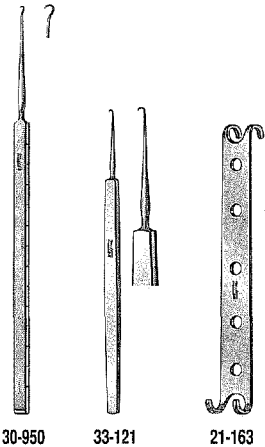

For additional Hooks see pages 188 - 194

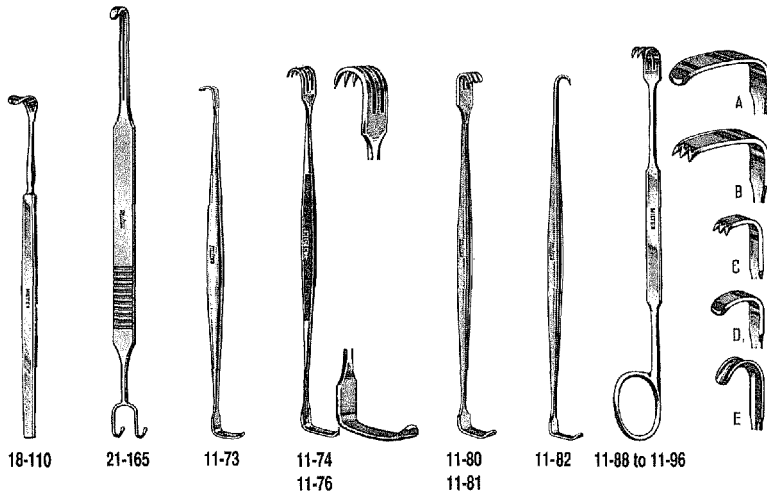

- 18-110** DESMARRS Alar Retractor 5½" (14 cm), 11 mm wide blade
- 21-165** COTTLE Knife Guide and Retractor 8" (20.3 cm), double end, ball tip prongs 10 mm wide, and 5 mm wide slotted hook
- 11-73** RAGNELL Retractor 6" (15.2 cm), double end 3 x 8 mm and 5 x 15 mm blades, delicate
- 11-74** SENN Retractor 6¾" (16.2 cm), double end, 3 sharp prongs
- 11-76** SENN Retractor 6¾" (16.2 cm), double end, 3 blunt prongs
- 11-80** MATHIEU Retractor 6½" (16.5 cm), double end, 3 sharp prongs
- 11-81** MATHIEU Retractor 6½" (16.5 cm), double end, 3 blunt prongs
- 11-82** MEYERDING Skin Hook and Retractor 6¼" (15.9 cm), double end
- 11-88** MEYERDING Finger Retractor 7" (17.8 cm), style A. Blade ¼" (.64 cm) x ⅛" (1.7 cm)
- 11-90** MEYERDING Finger Retractor 7" (17.8 cm), style B. Blade ⅛" (.48 cm) x ⅝" (1.6 cm)
- 11-92** MEYERDING Finger Retractor 7" (17.8 cm), style C. Blade ⅛" (.32 cm) x ¼" (.64 cm)
- 11-94** MEYERDING Finger Retractor 7" (17.8 cm), style D. Blade ⅝" (.24 cm) x ⅝" (1 cm)
- 11-96** MEYERDING Finger Retractor 7" (17.8 cm), style E. Blade ¼" (.64 cm) x ⅞" (2.2 cm)
- 23-1047** LUKENS Retractor 6¾" (17.1 cm), 10 mm wide curved and 7 mm wide angular blades

For a full line of Retractors see pages 151 - 187



23-1047



23-1049



21-176



21-180

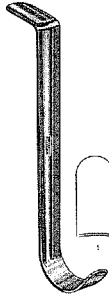

21-182 to 21-185

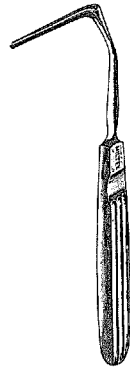
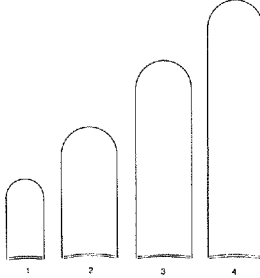

21-188

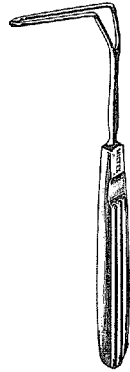

21-190

23-1049 JACKSON Retractor 7" (17.8 cm), double end, 2 blunt prongs $\frac{5}{16}$ " (2.4 cm) wide, and solid blade $\frac{3}{8}$ " (1 cm) wide

21-176 NEIVERT Knife Guide and Retractor 6 $\frac{1}{2}$ " (16.5 cm), double end, open blade 14 mm wide

21-180 LOVE Nerve Retractor 8 $\frac{1}{2}$ " (21.6 cm), blade 7 mm wide

21-182 CONVERSE Blade Retractor 3 $\frac{3}{4}$ " (9.5 cm), size 1

21-183 CONVERSE Blade Retractor 3 $\frac{3}{4}$ " (9.5 cm), size 2

21-184 CONVERSE Blade Retractor 3 $\frac{3}{4}$ " (9.5 cm), size 3

21-185 CONVERSE Blade Retractor 3 $\frac{3}{4}$ " (9.5 cm), size 4

21-188 AUFRICHT Nasal Retractor-Speculum 6 $\frac{1}{2}$ " (16.5 cm), solid blade 45 mm long

21-190 AUFRICHT Nasal Retractor 7" (17.8 cm), fenestrated blade 45 mm long

20-270 FREER Septum Chisel 6 $\frac{1}{2}$ " (16.5 cm), straight 4 mm wide

18-1960 FREER Septum Chisel 6 $\frac{1}{2}$ " (16.5 cm), curved 4 mm wide

20-274 FREER Septum Gouge 6 $\frac{1}{4}$ " (15.9 cm), straight 6 mm wide

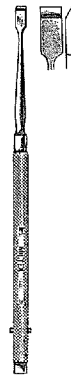

20-270

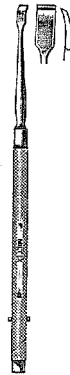

18-1960



20-274

For a full line of Retractors see pages 151 - 187

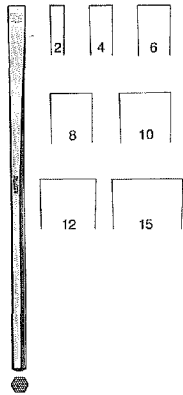

21-205

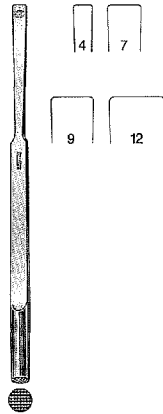

21-206



21-212

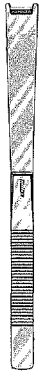

21-215 to 21-218

SHEEHAN OSTEOTOMES 6¼" (15.9 cm), hexagon handle

21-205-2	2 mm wide	21-205-10	10 mm wide
21-205-4	4 mm wide	21-205-12	12 mm wide
21-205-6	6 mm wide	21-205-15	15 mm wide
21-205-8	8 mm wide		

21-206-4 COTTLE Osteotome 7" (17.8 cm), 4 mm wide, rounded corners

21-206-7 COTTLE Osteotome 7" (17.8 cm), 7 mm wide, rounded corners

21-206-9 COTTLE Osteotome 7" (17.8 cm), 9 mm wide, rounded corners

21-206-12 COTTLE Osteotome 7" (17.8 cm), 12 mm wide, rounded corners

21-212 COTTLE Chisel 7¼" (18.4 cm), curved 5 mm, with depth graduations in cm.

21-215 CINELLI Osteotome 6½" (16.5 cm), with double guards, 10 mm cut

21-216 CINELLI Osteotome 6½" (16.5 cm), with double guards, 12 mm cut

21-217 CINELLI Osteotome 6½" (16.5 cm), with double guards, 14 mm cut

21-218 CINELLI Osteotome 6½" (16.5 cm), with double guards, 16 mm cut



Plastic Surgery Instruments



21-227

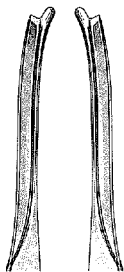

21-228

21-229



21-232



21-233

21-234



20-278 to 20-284

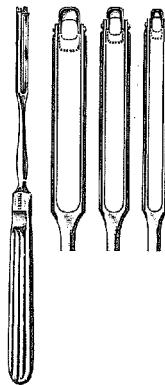

20-216 to 20-220



20-222
20-224

- 21-227 SILVER Osteotome 7" (17.8 cm), single guard, straight
- 21-228 SILVER Osteotome 7" (17.8 cm), single guard, right
- 21-229 SILVER Osteotome 7" (17.8 cm), single guard, left
- 21-232 NEIVERT Osteotome 8" (20.3 cm), straight, with single guard
- 21-233 NEIVERT-ANDERSON Osteotome 8" (20.3 cm), curved right, with single guard
- 21-234 NEIVERT-ANDERSON Osteotome 8" (20.3 cm), curved left, with single guard
- 20-278 BALLENGER V-Shaped Chisel 6¼" (15.9 cm), 2 mm wide
- 20-280 BALLENGER V-Shaped Chisel 6¼" (15.9 cm), 4 mm wide
- 20-282 BALLENGER V-Shaped Chisel 6¼" (15.9 cm), 6 mm wide
- 20-284 BALLENGER V-Shaped Chisel 6¼" (15.9 cm), 8 mm wide

BALLENGER SWIVEL KNIVES 7¼" (19.7 cm)

Straight	Width	Bayonet
20-216	3 mm	20-222
20-218	4 mm	20-224
20-220	5 mm	—



19-790

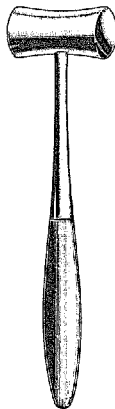

19-792



19-793 to 19-795

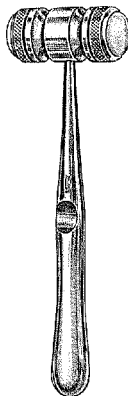

19-796



21-280



21-282
21-284



- 19-790 GERZOG Mallet 7½" (19.1 cm), head 8 oz. (226 g) lead filled with stainless jacket
- 19-792 LUCAE Mallet 7½" (19.1 cm), head 9 oz. (255 g), solid stainless
- 19-793 MILTEX Mallet 7½" (19.1 cm), lightweight 7.5 oz. (213 g), stainless head 1" (2.5 cm) dia. with 2 replaceable nylon caps
- 19-794 MILTEX Mallet 7½" (19.1 cm), lightweight 9 oz. (255 g), stainless head 1" (2.5 cm) dia. with 1 stainless face and 1 replaceable nylon cap
- 19-795 Nylon Cap Replacement for Nos. 19-793 and 19-794 Mallets
- 19-796 MEAD Mallet 7½" (19.1 cm), head 8 oz. (226 g) with 2 replaceable nylon caps
- 19-797 Nylon Cap Replacement for No. 19-796 Mallet
- 21-280 JOSEPH Nasal Saw 7½" (19.1 cm), straight
- 21-282 JOSEPH Nasal Saw 7½" (19.1 cm), bayonet, right
- 21-284 JOSEPH Nasal Saw 7½" (19.1 cm), bayonet, left
- 40-2000 MILTEX Nasal Saw 6" (15.2 cm), blade 2" (5.1 cm)



40-2000



Plastic Surgery Instruments

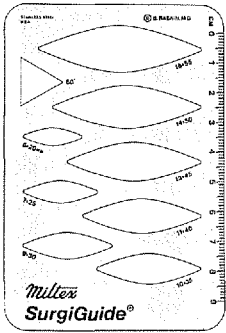

21-278

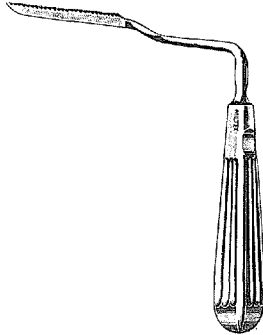

21-288
21-290

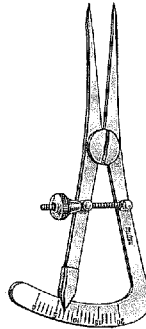

18-650



18-657

- 21-278 SURGIGUIDE Template for outlining lesions, 110 x 75 mm, flexible stainless steel
- 21-288 JOSEPH Nasal Saw, angled right
- 21-290 JOSEPH Nasal Saw, angled left
- 18-650 CASTROVIEJO Caliper 3 $\frac{1}{4}$ " (8.3 cm), a combination measuring and marking caliper, graduated 0-20 mm
- 18-657 THORPE Caliper 4 $\frac{1}{2}$ " (11.4 cm), graduated in inches and mm
- 18-658 JAMESON Caliper 3 $\frac{3}{4}$ " (9.5 cm), graduated in inches and mm, with thin tips
- 18-660 Flexible Stainless Ruler 6" (15.2 cm) x $\frac{1}{8}$ " (1.3 cm), graduated in $\frac{1}{32}$ " (.8 mm) fractions and mm
- 21-300 COTTLE Cartilage Crusher, 16 mm wide anvil, with removing forceps



18-658



18-660

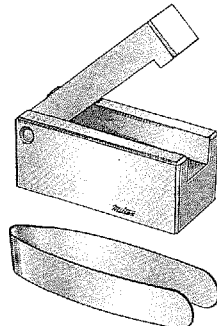

21-300

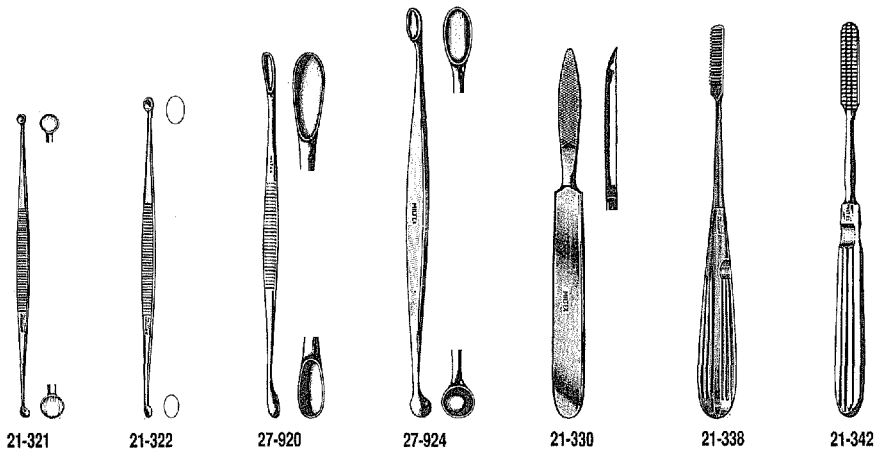

- 21-321 MARTINI Bone Curette 5½" (14 cm), double end, 4 mm and 5 mm round cups
- 21-322 WILLIGER Bone Curette 5½" (14 cm), double end, 3 mm and 4 mm oval cups
- 27-920 VOLKMAN Bone Curette 5½" (14 cm), double end, oval cups 5 x 10 mm and 6 x 20 mm
- 27-924 VOLKMAN Bone Curette 5½" (14 cm), double end, oval cups 6 x 10 mm and round cup 7 mm dia.
- 21-330 JOSEPH Rasp 6¼" (15.9 cm), fine cross serrations
- 21-338 COTTLE Rasp 8" (20.3 cm), backward cutting
- 21-342 MALTZ Rasp 7" (17.8 cm), backward cutting



21-343



21-346
21-348

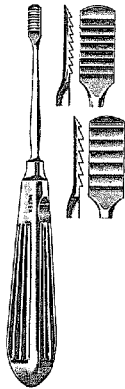

21-352
21-354



21-360



21-368 to 21-370



21-379

- 21-343 MALTZ Rasp 8¼" (21 cm), improved double end pattern, one end forward other end backward cutting
- 21-346 AUFRICHT Glabella Rasp 8¼" (21 cm), curved blade, forward cutting
- 21-348 AUFRICHT Glabella Rasp 8¼" (21 cm), curved blade, backward cutting
- 21-352 LEWIS Rasp 7½" (19.1 cm), fine teeth, backward cutting
- 21-354 LEWIS Rasp 7½" (19.1 cm), coarse teeth, backward cutting
- 21-360 GALLAHER Rasp 7½" (19.1 cm), coarse teeth, convex
- 21-368 FOMON Rasp 8¼" (21 cm), double end, 4-sided, fine and coarse teeth, both in flat and convex
- 21-369 FOMON Rasp 8¼" (21 cm), double end, coarse teeth flat and convex
- 21-370 FOMON Rasp 8¼" (21 cm), double end, fine teeth flat and convex
- 21-379 Stainless Wire Brush 6¼", for cleaning rasps and files, Autoclavable
- 3-1001 MILTEX Instrument Cleaning Brushes 7¼" (18.4 cm)
Stainless steel bristles. Designed to clean instrument serrations, rasps, files and burs (set of 3), Autoclavable



3-1001



6-24 to 6-30



6-28XL



18-780



18-782



18-784



18-779

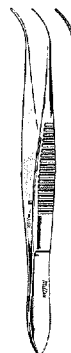

18-781

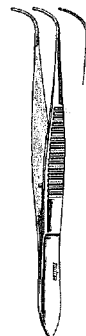

18-783

- 6-24 Dressing Forceps 4½" (11.4 cm), delicate pattern
- 6-26 Dressing Forceps 5" (12.7 cm), delicate pattern
- 6-28 Dressing Forceps 5½" (14 cm), delicate pattern
- 6-28XL Dressing Forceps 5½" (14 cm), delicate pattern, lightweight, fenestrated handles
- 6-30 Dressing Forceps 6" (15.2 cm), delicate pattern

EYE DRESSING FORCEPS 4" (10.2 cm), SERRATED TIPS

	Standard Pattern 0.8 mm wide tips		Extra Delicate Pattern 0.5 mm wide tips
18-780	Straight	18-779	Straight
18-782	Half curved	18-781	Half curved
18-784	Full curved	18-783	Full curved

For additional Dressing & Tissue Forceps see pages 64 - 82



Plastic Surgery Instruments



6-90 to 6-96



18-786
18-787



18-788



18-790



18-785



18-789



18-791

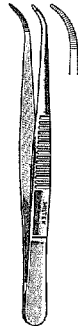

6-100

- 6-90 Tissue Forceps, 1 x 2 teeth, 4½" (11.4 cm), delicate pattern
- 6-92 Tissue Forceps, 1 x 2 teeth, 5" (12.7 cm), delicate pattern
- 6-94 Tissue Forceps, 1 x 2 teeth, 5½" (14 cm), delicate pattern
- 6-96 Tissue Forceps, 1 x 2 teeth, 6" (15.2 cm), delicate pattern

IRIS TISSUE FORCEPS 4" (10.2 cm), 1 x 2 TEETH

Standard Pattern
0.8 mm wide tips

- 18-786 Straight
- 18-787 Straight (Non Magnetic)
- 18-788 Half curved
- 18-790 Full curved

Extra Delicate Pattern
0.5 mm wide tips

- 18-785 Straight
- 18-789 Half curved
- 18-791 Full curved

- 6-100 Dressing Forceps 5" (12.7 cm), curved fine tips

For additional Dressing & Tissue Forceps see pages 64 - 82

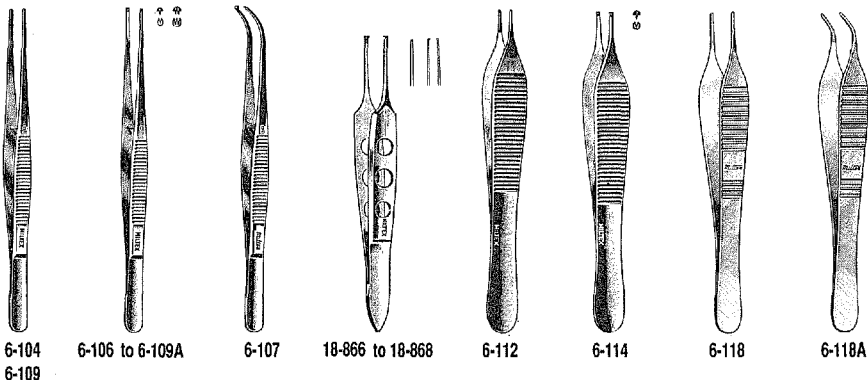

- 6-104** SEMKEN Dressing Forceps 5" (12.7 cm), serrated
- 6-106** SEMKEN Tissue Forceps 5" (12.7 cm), 1 x 2 teeth
- 6-107** SEMKEN Tissue Forceps 5" (12.7 cm), 1 x 2 teeth, curved tips
- 6-108** SEMKEN Tissue Forceps 5" (12.7 cm), 2 x 3 teeth
- 6-109** SEMKEN Dressing Forceps 6" (15.2 cm), serrated
- 6-109A** SEMKEN Tissue Forceps 6" (15.2 cm), 1 x 2 teeth

- 18-866** BISHOP-HARMON Dressing Forceps 3 $\frac{3}{8}$ " (8.6 cm), fine cross-serrated tips 0.5 mm wide
- 18-867** BISHOP-HARMON Micro Tissue Forceps 3 $\frac{3}{8}$ " (8.6 cm), delicate 0.3 mm 1 x 2 teeth
- 18-868** BISHOP-HARMON Tissue Forceps 3 $\frac{3}{8}$ " (8.6 cm), standard 0.7 mm 1 x 2 teeth

- 6-112** HUDSON (EWALD) Dressing Forceps 4 $\frac{3}{4}$ " (12.1 cm), serrated
- 6-114** HUDSON (EWALD) Tissue Forceps 4 $\frac{3}{4}$ " (12.1 cm), 1 x 2 teeth

- 6-118** ADSON Dressing Forceps 4 $\frac{3}{4}$ " (12.1 cm), serrated, delicate
- 6-118A** ADSON Dressing Forceps 4 $\frac{3}{4}$ " (12.1 cm), serrated, delicate, angled
- 6-118XL** ADSON Dressing Forceps 4 $\frac{3}{4}$ " (12.1 cm), serrated, lightweight, fenestrated handles

- 17-2510** Micro ADSON Dressing Forceps 4 $\frac{3}{4}$ " (12.1 cm), serrated tips, 0.5 mm wide

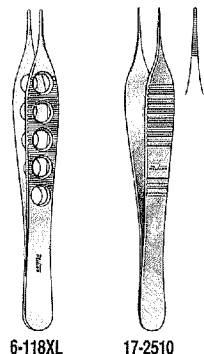

For additional Dressing & Tissue Forceps see pages 64 - 82



6-120
6-122



6-120A



6-120XL



6-121



17-2500

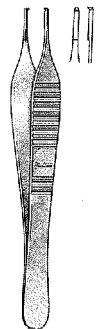

6-123

- 6-120 ADSON Tissue Forceps 4¾" (12.1 cm), 1 x 2 teeth, delicate
- 6-120A ADSON Tissue Forceps 4¾" (12.1 cm), 1 x 2 teeth, delicate, angled
- 6-120XL ADSON Tissue Forceps 4¾" (12.1 cm), 1 x 2 teeth, lightweight, fenestrated handles
- 6-121 ADSON Tissue Forceps 4¾" (12.1 cm), 1 x 2 teeth and serrated, delicate
- 17-2500 Micro ADSON Tissue Forceps 4¾" (12.1 cm), tips 0.5 mm wide, 1 x 2 teeth
- 6-122 ADSON Tissue Forceps 4¾" (12.1 cm), 2 x 3 teeth, delicate
- 6-123 ADSON Tissue and Suture Forceps 4¾" (12.1 cm), 1 x 2 teeth with tying platform
- 6-123XL ADSON Tissue Forceps 4¾" (12.1 cm), with platform 1 x 2 teeth, lightweight, fenestrated handles

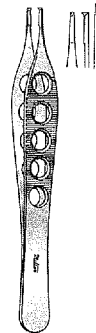

6-123XL

For additional Dressing & Tissue Forceps see pages 64 - 82

Carb-N-Sert Forceps with tungsten carbide inserts are shown on pages 88, 89



6-124

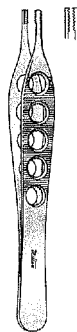

6-124XL

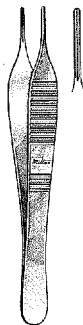

6-125



6-126



6-134



6-138
6-140



18-850



18-854

- 6-124 BROWN-ADSON Tissue Forceps 4 $\frac{3}{4}$ " (12.1 cm), 7 x 7 side grasping teeth
- 6-124XL BROWN-ADSON Tissue Forceps 4 $\frac{3}{4}$ " (12.1 cm), 7 x 7 side grasping teeth, lightweight, fenestrated handles
- 6-125 DeBAKEY-ADSON Tissue Forceps 4 $\frac{3}{4}$ " (12.1 cm), atraumatic tips 1.5 mm wide
- 6-126 BROWN-ADSON Tissue Forceps 4 $\frac{3}{4}$ " (12.1 cm), 7 x 7 side grasping teeth, angular
- 6-134 MARTIN Tissue Forceps 6" (15.2 cm), 7 x 8 teeth
- 6-138 BROWN Tissue Forceps 6" (15.2 cm), 8 x 8 side grasping teeth
- 6-140 BROWN Tissue Forceps 8" (20.3 cm), 8 x 8 side grasping teeth
- 18-850 GRAEFE Fixation Forceps 4 $\frac{3}{8}$ " (11.2 cm), standard jaws 4.5 mm wide, with fine teeth
- 18-854 GRAEFE Fixation Forceps 4 $\frac{3}{8}$ " (11.2 cm), standard jaws 4.5 mm wide, with fine teeth, with catch
- 24-570XL DeBAKEY Tissue Forceps 6" (15.2 cm), atraumatic teeth, 1.5 mm wide tips, lightweight, fenestrated handles

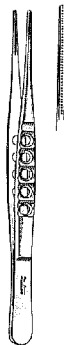

24-570XL

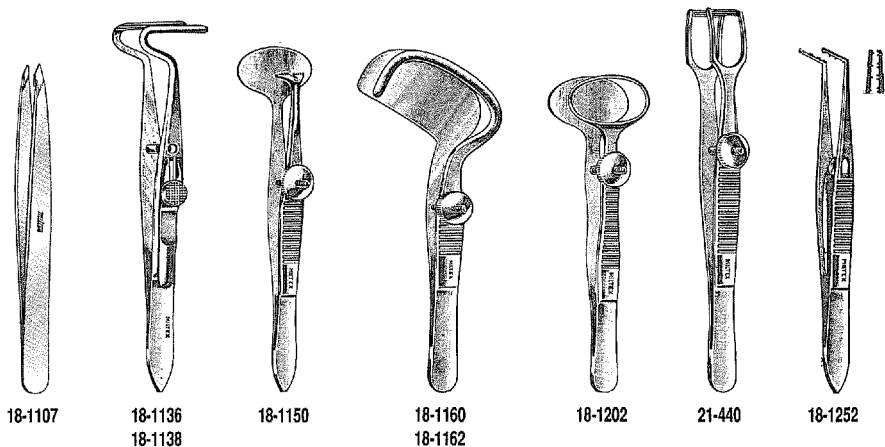

- 18-1107** Swiss Cilia and Suture Forceps $3\frac{3}{4}$ " (9.5 cm), precision fitted diagonal jaws 3 mm wide
- 18-1136** BERKE Ptosis Forceps 4" (10.2 cm), blades 20 mm with longitudinal serrations, with slide lock
- 18-1138** BERKE Ptosis Forceps 4" (10.2 cm), blades 27 mm with longitudinal serrations, with slide lock
- 18-1150** ERHARDT Lid Forceps $3\frac{1}{2}$ " (8.9 cm), serrated jaws 9.5 mm wide
- 18-1160** SNELLEN Entropium Forceps $3\frac{1}{2}$ " (8.9 cm), left, 35 mm wide plate
- 18-1162** SNELLEN Entropium Forceps $3\frac{1}{2}$ " (8.9 cm), right, 35 mm wide plate
- 18-1202** DESMARRES Chalazion Forceps $3\frac{1}{2}$ " (8.9 cm), inside ring measures 12 x 23 mm
- 21-440** COTTLE Columella Forceps $4\frac{1}{2}$ " (11.4 cm), jaws 10 mm wide
- 18-1252** PRINCE Muscle Forceps $3\frac{3}{4}$ " (9.5 cm)

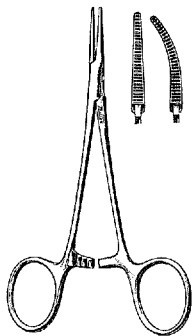

7-2
7-4

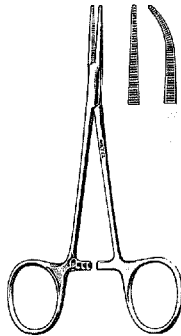

7-8
7-10

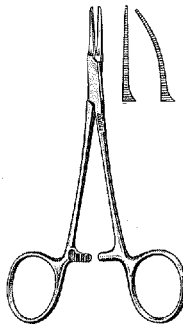

7-11
7-12

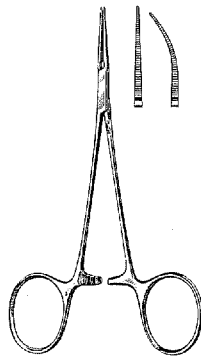

17-2600
17-2602

7-2 HALSTED Mosquito Forceps 5" (12.7 cm), straight, standard pattern

7-4 HALSTED Mosquito Forceps 5" (12.7 cm), curved, standard pattern

7-8 HALSTED Mosquito Forceps 5" (12.7 cm), straight, extra delicate

7-10 HALSTED Mosquito Forceps 5" (12.7 cm), curved, extra delicate

7-11 PACKER Mosquito Forceps 5" (12.7 cm), straight, flat jaws

7-12 PACKER Mosquito Forceps 5" (12.7 cm), curved, flat jaws

17-2600 JACOBSON Micro Mosquito Forceps 5" (12.7 cm), straight, extremely delicate

17-2602 JACOBSON Micro Mosquito Forceps 5" (12.7 cm), curved, extremely delicate

7-24 HARTMAN Mosquito Forceps 3½" (8.9 cm), straight

7-26 HARTMAN Mosquito Forceps 3½" (8.9 cm), curved

7-30 PROVIDENCE Hospital Forceps 5½" (14 cm), straight

7-32 PROVIDENCE Hospital Forceps 5½" (14 cm), curved

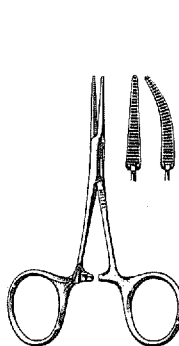

7-24
7-26

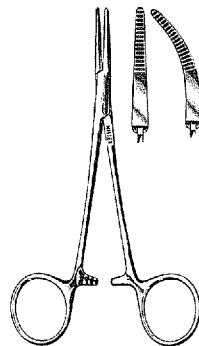

7-30
7-32



Plastic Surgery Instruments

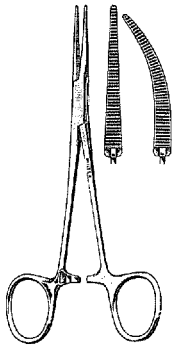

7-50
7-52

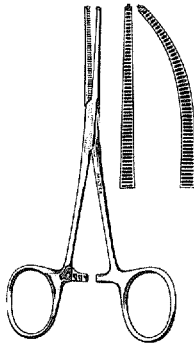

7-70
7-72

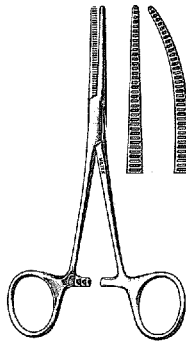

7-110
7-112

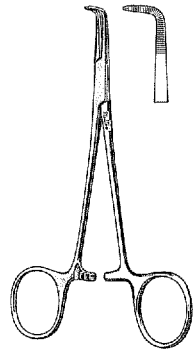

7-210

- 7-50 Baby CRILE Forceps 5 1/2" (14 cm), straight, extra delicate
- 7-52 Baby CRILE Forceps 5 1/2" (14 cm), curved, extra delicate
- 7-70 Baby OCHSNER Forceps 5 1/2" (14 cm), straight, 1 x 2 teeth, extra delicate
- 7-72 Baby OCHSNER Forceps 5 1/2" (14 cm), curved, 1 x 2 teeth, extra delicate
- 7-110 Baby PEAN Forceps 5 1/2" (14 cm), straight, extra delicate
- 7-112 Baby PEAN Forceps 5 1/2" (14 cm), curved, extra delicate
- 7-210 Baby MIXTER Forceps 5 1/4" (13.3 cm), fully curved, extra delicate
- 7-300 DIEFFENBACH Serrefine 2 1/4" (5.7 cm), straight
- 7-302 DIEFFENBACH Serrefine 2 1/4" (5.7 cm), curved
- 7-304 DIEFFENBACH Serrefine 1 1/2" (3.8 cm), straight
- 7-305 DIEFFENBACH Serrefine 1 1/2" (3.8 cm), curved
- 7-310 DIETHRICH Micro Bulldog Clamp 1 1/8" (4.7 cm), straight jaws
8 mm x 1.2 mm
- 7-315 DIETHRICH Micro Bulldog Clamp 1 1/4" (4.4 cm), angled jaws
8 mm x 1.2 mm



7-300
7-304



7-302
7-305



7-310



7-315

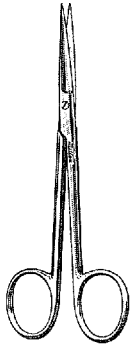

5-270
5-271

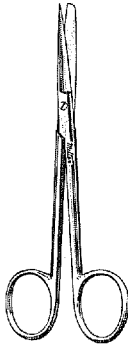

5-272
5-273



5-274
5-275

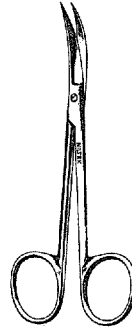

5-276
5-277

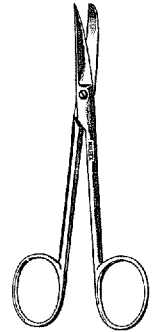

5-278
5-279

MILTEX PLASTIC SURGERY SCISSORS 4 3/4" (12.1 cm)

Straight

- 5-270 Sharp-Sharp Points
- 5-271 Sharp-Sharp Points, serrated blade
- 5-272 Sharp-Blunt Points
- 5-273 Sharp-Blunt Points, serrated blade
- 5-274 Blunt-Blunt Points
- 5-275 Blunt-Blunt Points, serrated blade

Curved

- 5-276
- 5-277
- 5-278
- 5-279
- 5-280
- 5-281

Angled on Side

- 5-282 Sharp-Sharp Points
- 5-282A Sharp-Sharp Points, serrated blade

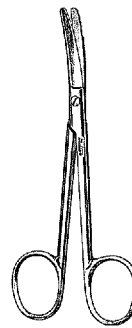

5-280
5-281

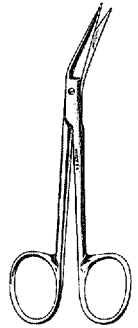

5-282
5-282A

For Carb-N-Sert Scissors with tungsten carbide blades see pages 55 - 59

For SuperCut Scissors see pages 60 - 63



Plastic Surgery Instruments

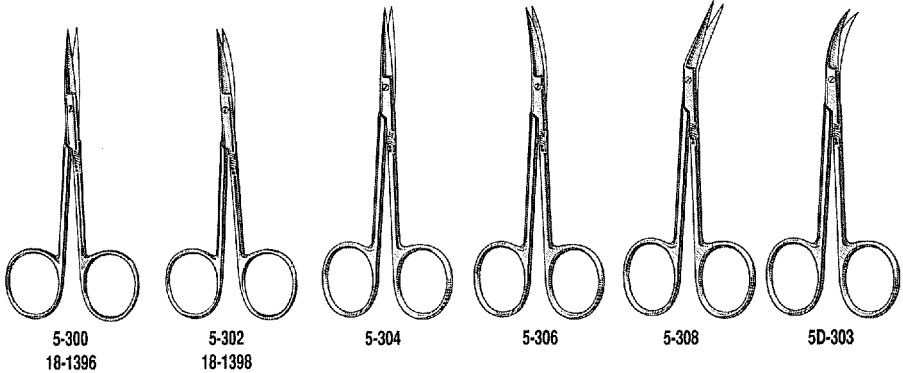

- 18-1396** Iris Scissors 3½" (8.9 cm), with 20 mm blades, straight, very delicate
- 18-1398** Iris Scissors 3½" (8.9 cm), with 20 mm blades, curved, very delicate
- 5-300** Iris Scissors 4" (10.2 cm), straight, delicate
- 5-302** Iris Scissors 4" (10.2 cm), curved, delicate
- 5-304** Iris Scissors 4½" (11.4 cm), straight
- 5-306** Iris Scissors 4½" (11.4 cm), curved
- 5-308** Iris Scissors 4½" (11.4 cm), angled on side
- 5D-303** Iris Scissors 4½" (11.4 cm), curved sideways
- 18-1415*** Iris Scissors 4" (10.2 cm), straight, standard pattern, ribbon type
- 18-1416*** Iris Scissors 4" (10.2 cm), curved, standard pattern, ribbon type
- 18-1417*** Iris Scissors 3½" (8.9 cm), straight, miniature 14 mm blades, ribbon type
- 18-1418*** Iris Scissors 3½" (8.9 cm), curved, miniature 14 mm blades, ribbon type

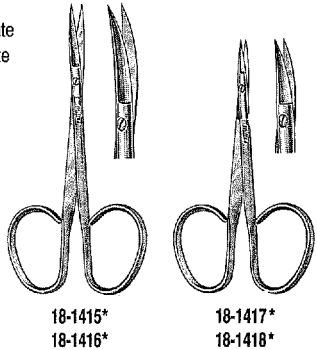

For Carb-N-Sert Scissors with tungsten carbide inserts see pages 55 - 59

For SuperCut Scissors see pages 60 - 63

*Ribbon type scissors have extra large finger rings; shanks and rings have satin finish; blades are highly polished.

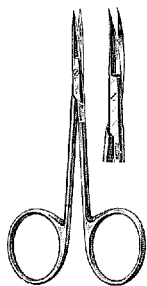

18-1392
18-1394

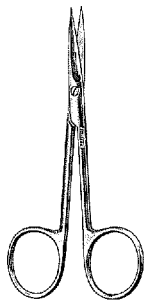

18-1404

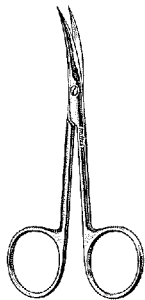

18-1405

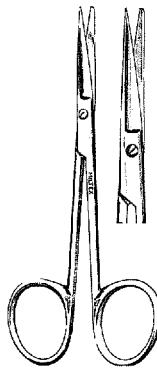

18-1420
18-1422

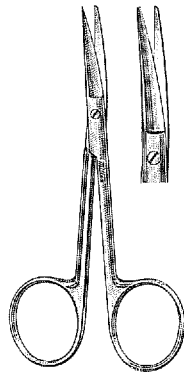

18-1426
18-1428

- 18-1392 BONN Miniature Iris Scissors 3½" (8.9 cm), with 15 mm blades, straight
- 18-1394 BONN Miniature Iris Scissors 3½" (8.9 cm), with 15 mm blades, curved
- 18-1404 MILTEX Iris Scissors 4" (10.2 cm), straight, heavy pattern
- 18-1405 MILTEX Iris Scissors 4" (10.2 cm), curved, heavy pattern
- 18-1420 KNAPP Iris Scissors 4" (10.2 cm), straight, sharp-blunt points
- 18-1422 KNAPP Iris Scissors 4" (10.2 cm), straight, blunt-blunt points
- 18-1426 KNAPP Iris Scissors 4" (10.2 cm), curved, sharp-blunt points
- 18-1428 KNAPP Iris Scissors 4" (10.2 cm), curved, blunt-blunt points
- 5-310 Eye Scissors with Probe Points, 4½" (11.4 cm), angled on side

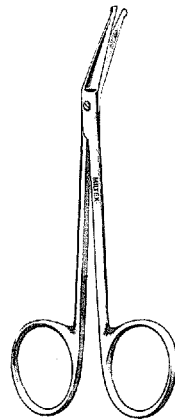

5-310

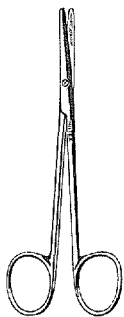

5-312

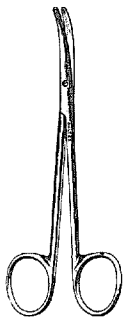

5-314

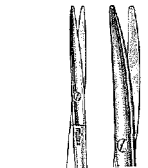

18-1453*
18-1454*

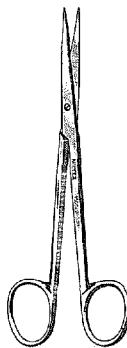

5-316

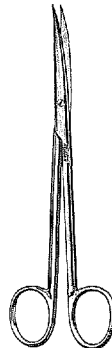

5-318
5D-326

- 5-312** Strabismus Scissors 4" (10.2 cm), straight
5-314 Strabismus Scissors 4" (10.2 cm), curved
18-1453* Strabismus Scissors 4½"(11.4 cm), straight, ribbon type
18-1454* Strabismus Scissors 4½"(11.4 cm), curved, ribbon type
5-316 BROPHY Gum and Suture Scissors 5½" (14 cm), straight
5-318 BROPHY Gum and Suture Scissors 5½" (14 cm), curved
5D-326 BROPHY Gum and Suture Scissors 5½" (14 cm), curved, one serrated blade

STEVENS TENOTOMY SCISSORS

4½" (10.5 cm) With Short Blades

- 18-1460** straight, sharp points
18-1462 straight, blunt points
18-1464 curved, sharp points
18-1466 curved, blunt points

4½" (11.4 cm) With Long Blades

- 18-1470**
18-1472
18-1474
18-1476

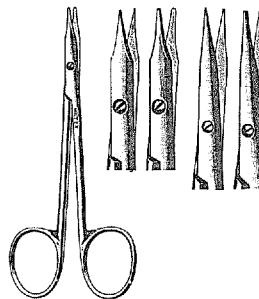

18-1460 to 18-1476

*Ribbon type scissors have extra large finger rings; shanks and rings have satin finish; blades are highly polished.

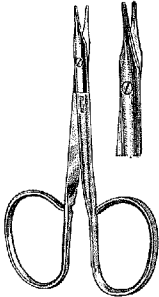

18-1477*
18-1478*

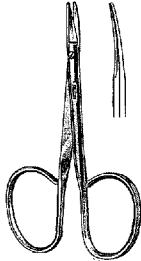

18-1419*

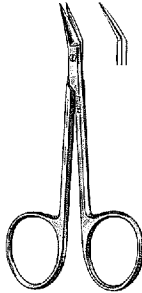

18-1440

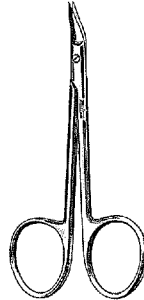

33-240

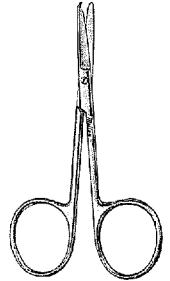

9-100

18-1477* STEVENS Tenotomy Scissors 3 $\frac{3}{4}$ " (9.5 cm), straight, blunt points, ribbon type

18-1478* STEVENS Tenotomy Scissors 3 $\frac{3}{4}$ " (9.5 cm), curved, blunt points, ribbon type

18-1419* Utility Scissors 3 $\frac{3}{4}$ " (9.5 cm), curved blunt blades 15 mm long, ribbon type

18-1440 CONVERSE (WILMER) Nasal Scissors 4" (10.2 cm), angled on flat

33-240 BIRO Dermal Naevus Scissors 4" (10.2 cm), angled on flat, with sharp outside edges

9-100 SPENCER Stitch Scissors 3 $\frac{1}{2}$ " (8.9 cm), straight

9-101 SHORTBENT Stitch Scissors 3 $\frac{1}{2}$ " (8.9 cm), curved to side

9-102 LITTAUER JR. Stitch Scissors 4 $\frac{1}{2}$ " (11.4 cm), light pattern

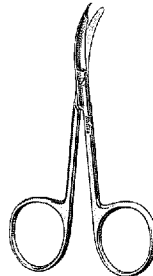

9-101

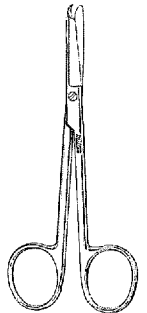

9-102

For Carb-N-Sert Scissors with tungsten carbide inserts see pages 55 - 59

For SuperCut Scissors see pages 60 - 63

*Ribbon type scissors have extra large finger rings; shanks and rings have satin finish; blades are highly polished.

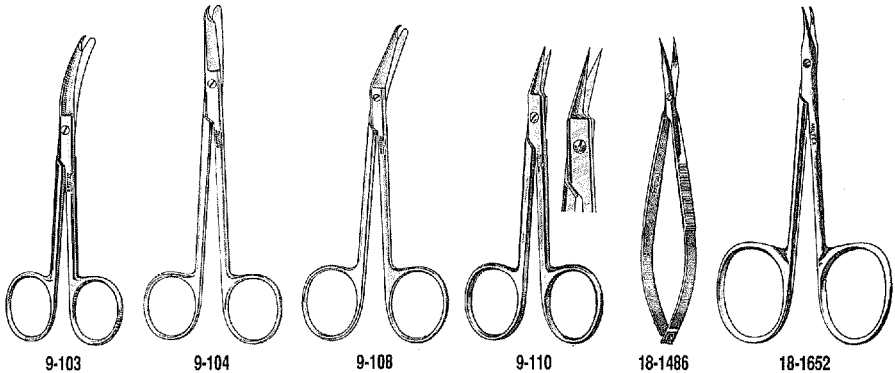

- 9-103** NORTHBENT Stitch Scissors 4¾" (12.1 cm),
curved, light pattern
- 9-104** LITTAUER Stitch Scissors 5½" (14 cm),
standard pattern
- 9-108** MILTEX Stitch Scissors 4½" (11.4 cm), angled,
delicate
- 9-110** O'BRIEN Stitch Scissors 3¾" (9.5 cm), angled to side,
sharp points
- 18-1486** WESTCOTT Stitch Scissors 4½" (11.4 cm), curved,
sharp points
- 18-1652** Eye Suture (GRADLE) Scissors 3¾" (9.5 cm),
slightly curved, sharp points
- 18-1653*** Eye Suture Scissors 4" (10.4 cm), slightly curved,
sharp points, ribbon type
- 21-536** LITTLER Suture Carrying Scissors 4⅝" (11.8 cm),
with suture hole in blades, curved

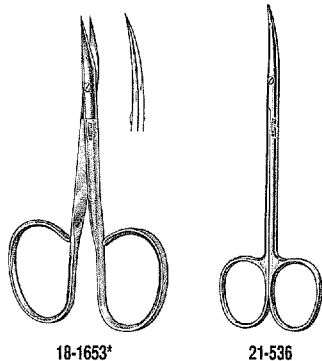

*Ribbon type scissors have extra large finger rings; shanks and rings have satin finish; blades are highly polished.



5-180
5-182

5-284 to 5-288

5-290
5-291

33-242

5-320

5D-322

- 5-180 METZENBAUM Scissors 5½" (14 cm), curved, standard
- 5-182 METZENBAUM Scissors 7" (17.8 cm), curved, standard
- 5-284 METZENBAUM Scissors 5" (12.7 cm), curved, delicate
- 5-286 METZENBAUM Scissors 6" (15.2 cm), curved, delicate
- 5-288 METZENBAUM Scissors 7" (17.8 cm), curved, delicate

- 5-290 RAGNELL Undermining Scissors 5" (12.7 cm), curved with flattened dissecting tips
- 5-291 RAGNELL Undermining Scissors 7" (17.8 cm), curved with flattened dissecting tips

- 33-242 MILTEX Undermining Scissors 4½" (11.4 cm), curved blades, with flat pointed tip

- 5-320 GOLDMAN-FOX Wound Debridement Scissors 5" (12.7 cm), curved fine tips, with one serrated blade

- 5D-322 GOLDMAN-FOX Wound Debridement Scissors 5" (12.7 cm), double curved, with one serrated blade

- 5D-324 LaGRANGE Scissors 4¼" (10.8 cm), curved, one serrated blade, angled shanks

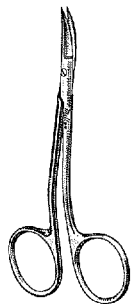

5D-324

For Carb-N-Sert Scissors with tungsten carbide inserts see pages 55 - 59

For SuperCut Scissors see pages 60 - 63



Plastic Surgery Instruments

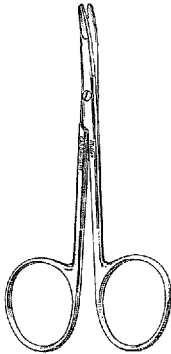

21-537TC

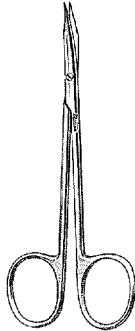

21-539



5-172
5-176

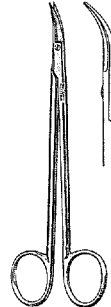

21-558
21D-559

- 21-537TC** MILTEX Blepharoplasty Scissors 4½" (11.4 cm), curved flat tips, one serrated and one CARB-N-SERT blade
- 21-539** KLEINERT-KUTZ Tenotomy Scissors 4¾" (12.4 cm), curved, rounded dissecting blades
- 5-172** REYNOLDS Dissecting Scissors 6" (15.2 cm), curved tenotomy type dissecting tips
- 5-176** REYNOLDS Dissecting Scissors 7" (17.8 cm), curved tenotomy type dissecting tips
- 21-558** QUIMBY Scissors 5" (12.7 cm), blades 15 mm, strongly curved and pointed
- 21D-559** QUIMBY Scissors 5" (12.7 cm), blades 15 mm, strongly curved and pointed, one serrated blade
- 21-560** TAYLOR Dural Scissors 5½" (14 cm), with probe tip

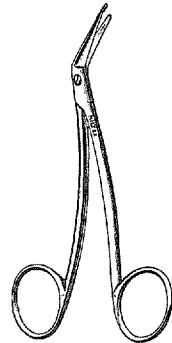

21-560

For Carb-N-Sert Scissors with tungsten carbide inserts see pages 55 - 59

For SuperCut Scissors see pages 60 - 63

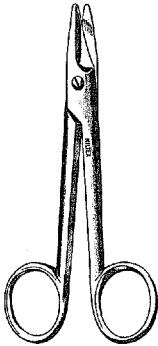

5-152
5-154

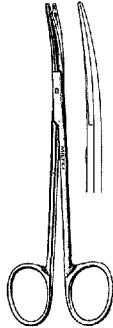

21-600

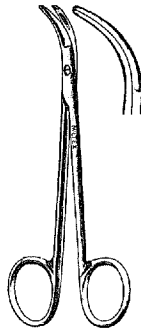

21-602



21-604

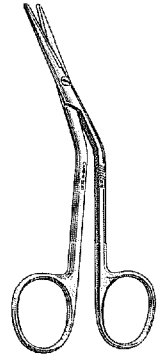

21-604TC

- 5-152 SISTRUNK Scissors 5½" (14 cm), heavy pattern, straight
- 5-154 SISTRUNK Scissors 5½" (14 cm), heavy pattern, slightly curved
- 21-600 FOMON Saber-Back Scissors 5" (12.7 cm), slightly curved blades with semi-sharp outer edges used for dissection
- 21-602 FOMON Lower Lateral Scissors 5" (12.7 cm), strong curve, dissecting blades
- 21-604 FOMON Dorsal Scissors 5½" (14 cm), light pattern, angular shanks
- 21-604TC FOMON Dorsal Scissors 5½" (14 cm), angular shanks, CARB-N-SERT blades, one serrated blade
- 21-605 MILTEX Saber-Back Rhytidectomy Scissors 6½" (16.5 cm), curved with semi-sharp outer edges used for dissection
- 21-606 CASTANARES Facelift Scissors 6¼" (15.9 cm), straight, short strong blades

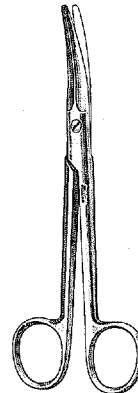

21-605

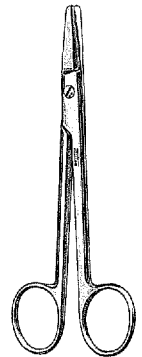

21-606

For Carb-N-Sert Scissors with tungsten carbide blades see pages 55 - 59

For SuperCut Scissors see pages 60 - 63

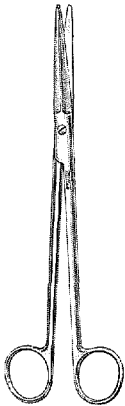

21-607

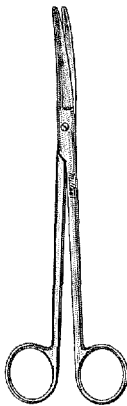

21-608

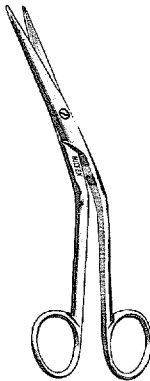

21-610

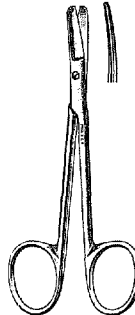

21-612

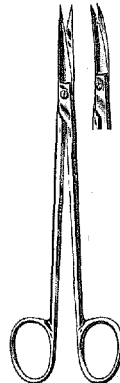

21-630
21-632

- 21-607 GORNEY Facelift Scissors 7 3/4" (19.7 cm), straight, one serrated blade
- 21-608 GORNEY Facelift Scissors 7 3/4" (19.7 cm), slightly curved, one serrated blade
- 21-610 COTTLE Dorsal Scissors 6 1/2" (16.5 cm), heavy pattern with rounded blades, angular shanks
- 21-612 COTTLE Bulldog Nasal Scissors 4 1/2" (11.4 cm), slightly curved blunt blades
- 21-630 JOSEPH Nasal Scissors 5 3/4" (14.6 cm), straight, sharp points
- 21-632 JOSEPH Nasal Scissors 5 3/4" (14.6 cm), curved, sharp points
- 21-621 GORNEY Septal Scissors 7 3/4" (19.7 cm), double action, angled handle, serrated blades with 1 3/4" (4.4 cm) cut
- 21-622 CAPLAN Nasal Bone Scissors 8" (20.3 cm), double action, serrated blades

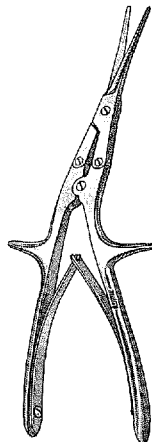

21-621

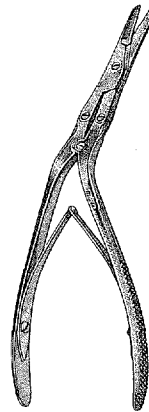

21-622

For Carb-N-Sert Scissors with tungsten carbide inserts see pages 55 - 59

For SuperCut Scissors see pages 60 - 63

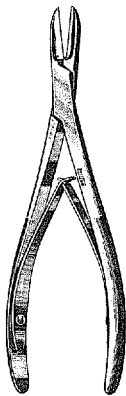

21-624

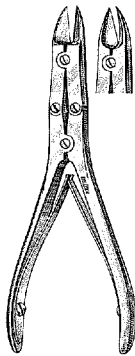

21-626
21-627

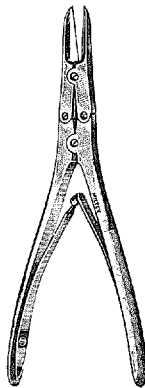

21-628

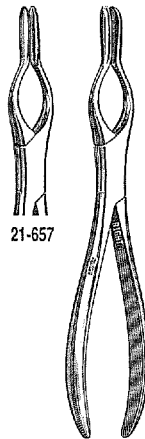

21-657



21-660



21-900

- 21-624 KAZANJIAN Nasal Cutting Forceps 7½" (19.1 cm), light model
- 21-626 KLEINERT-KUTZ (RUSKIN) Bone Cutting Forceps 6" (15.2 cm), straight
- 21-627 KLEINERT-KUTZ (RUSKIN) Bone Cutting Forceps 6" (15.2 cm), curved
- 21-628 RUSKIN (ROWLAND) Nasal Hump Forceps 7" (17.8 cm), double action, narrow jaws
- 21-657 WALSHAM Septum Straightener 9¼" (23.5 cm), Universal, with two convex blades
- 21-658 WALSHAM Septum Straightener 9¼" (23.5 cm), right, with one convex and one concave blade
- 21-659 WALSHAM Septum Straightener 9¼" (23.5 cm), left, with one convex and one concave blade
- 21-660 ASH Septum Straightener 9" (22.9 cm), angled blades flat inside
- 21-900 OBWEGESER Mandibular Awl for wire suturing 5½" (14 cm), slightly curved
- 21-901 OBWEGESER Mandibular Awl for wire suturing 7" (17.8 cm), strong curve
- 21-902 OBWEGESER Zygomatic Arch Awl for wire suturing 9" (22.9 cm), slightly curved



21-901



21-902

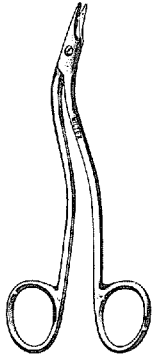

9-96

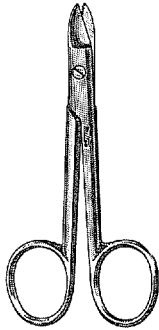

9-120
9D-121

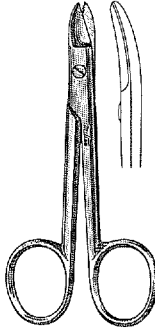

9-122
9D-123

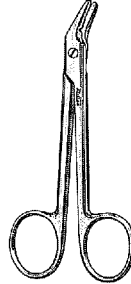

9-124

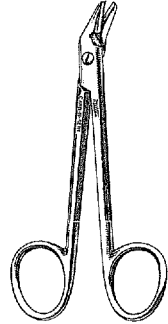

9-124TC

9-96 HEATH Wire Cutting Scissors 6¼" (15.9 cm), one serrated blade

WIRE CUTTING SCISSORS 4¾" (12.1 cm)

9-120 Straight, one serrated blade

9D-121 Straight

9-122 Curved, one serrated blade

9D-123 Curved

9-124 Angled to side, one serrated blade

9-124TC Angled to side, one serrated blade, Carb-N-Sert inserts

WIRE CUTTING SCISSORS 4¼" (10.8 cm)

9D-132 Straight, one serrated blade

9D-133 Straight

9D-134 Curved, one serrated blade

9D-135 Curved

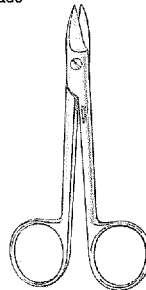

9D-132
9D-133

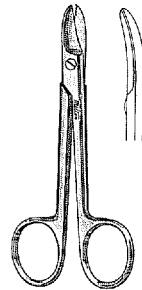

9D-134
9D-135

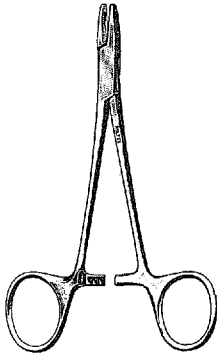

8-2

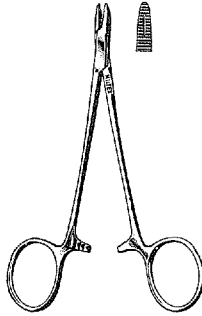

8-4

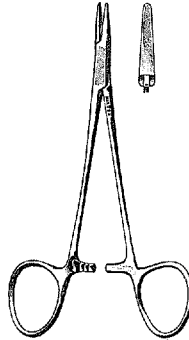

8-6

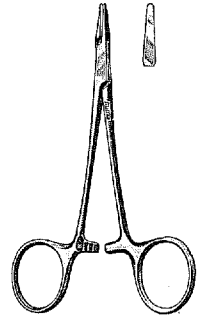

8-7

8-2 COLLIER Needle Holder 5" (12.7 cm), fenestrated jaws

8-4 DERF Needle Holder 4¾" (12.1 cm)

8-6 WEBSTER Needle Holder 5" (12.7 cm), delicate, smooth jaws, standard pattern

8-7 WEBSTER Needle Holder 4¾" (12.1 cm), extra delicate, smooth jaws

8-8 HALSEY Needle Holder 5" (12.7 cm), smooth jaws

8D-36 HALSEY Needle Holder 5" (12.7 cm), serrated jaws

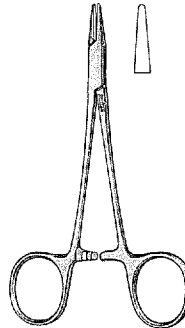

8-8

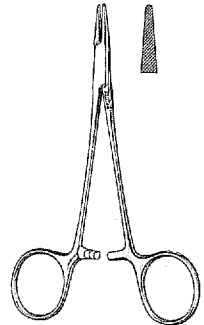

8D-36

For Carb-N-Sert Needle Holders with tungsten carbide inserts see pages 123 - 130

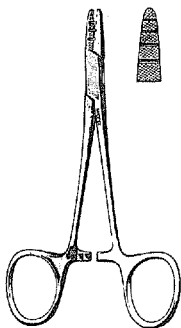

8-10

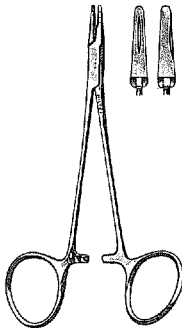

8-12

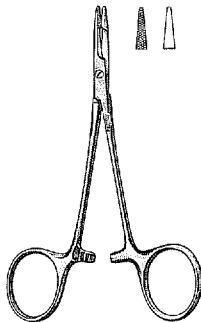

8-14
8-14A

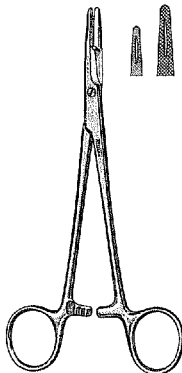

8-15
8-16

- 8-10 ABBEY Needle Holder 5" (12.7 cm)
- 8-12 NEIVERT Needle Holder 5" (12.7 cm), one offset ring
- OLSEN-HEGAR NEEDLE HOLDERS,
combined with Suture Scissors
- 8-14 4¾" (12.1 cm), Extra Delicate Pattern, serrated jaws
- 8-14A 4¾" (12.1 cm), Extra Delicate Pattern, smooth jaws
- 8-15 5½" (14 cm), serrated jaws
- 8-16 6½" (16.5 cm), serrated jaws
- 8-20 CONVERSE Needle Holder 4¼" (10.8 cm), longitudinal serrations, large finger rings

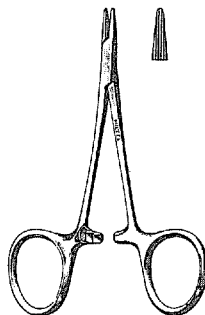

8-20

For Carb-N-Sert Needle Holders with tungsten carbide inserts see pages 123 - 130

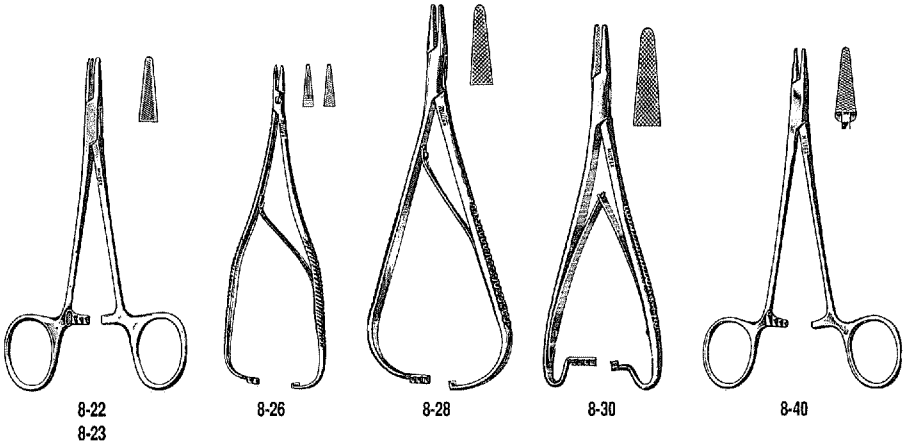

- 8-22 BROWN Needle Holder 5½" (13.3 cm), convex jaws, fine serrations
- 8-23 BROWN Needle Holder 6¾" (17.1 cm), convex jaws, fine serrations
- 8-26 BOYNTON Needle Holder 5" (12.7 cm), delicate
- 8-28 MATHIEU Needle Holder 5½" (14 cm), with spring handles
- 8-30 MATHIEU Needle Holder 6¾" (15.9 cm), with spring handles
- 8-40 BAUMGARTNER Needle Holder 5½" (14 cm)
- 8-42 MAYO-HEGAR Needle Holder 5" (12.7 cm)
- 8-44 MAYO-HEGAR Needle Holder 6" (15.2 cm)
- 8-46 MAYO-HEGAR Needle Holder 7" (17.8 cm)

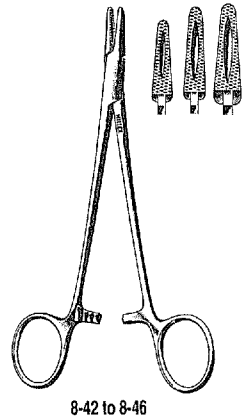

For Carb-N-Sert Needle Holders with tungsten carbide inserts see pages 123 - 130

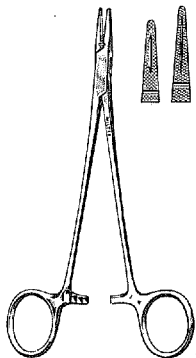

8-50
8-51

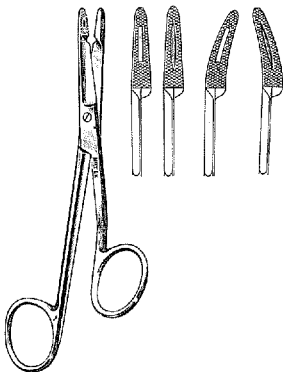

8-58
8-59

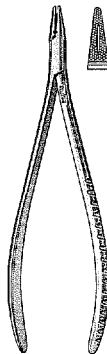

8-94

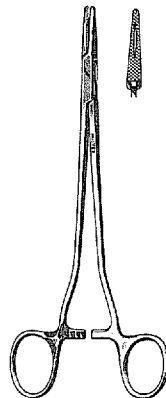

8-96

8-50 CRILE-WOOD Needle Holder 6" (15.2 cm)

8-51 CRILE-WOOD Needle Holder 7" (17.8 cm)

8-58 GILLIES-SHEEHAN Needle Holder, with Suture Scissors 6½" (16.5 cm), straight

8-59 GILLIES-SHEEHAN Needle Holder, with Suture Scissors 6½" (16.5 cm), curved

8-94 CRILE Needle Holder 6" (15.2 cm)

8-96 SAROT Needle Holder 7⅛" (18.1 cm), light model

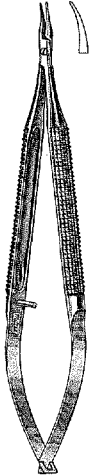

17-1000

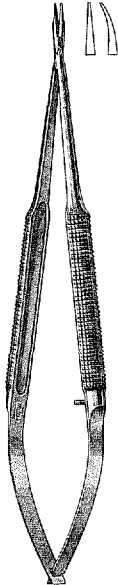

17-980
17-1010

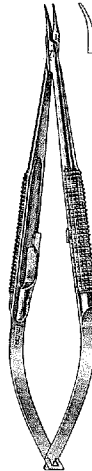

17-1020

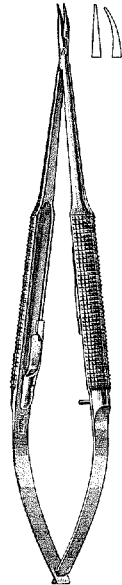

17-1024
17-1025

MILTEX Micro Surgery Needle Holders
with round handles, 0.6 mm tips

- | | |
|---------|---|
| 17-1000 | 5¼" (13.3 cm), curved jaws |
| 17-980 | 7½" (18.1 cm), straight jaws |
| 17-1010 | 7½" (18.1 cm), curved jaws |
| 17-1020 | 5¼" (13.3 cm), curved jaws, with lock |
| 17-1024 | 7½" (18.1 cm), straight jaws, with lock |
| 17-1025 | 7½" (18.1 cm), curved jaws, with lock |

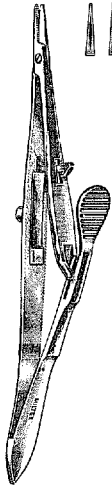

18-1800

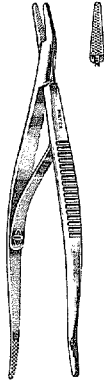

18-1810

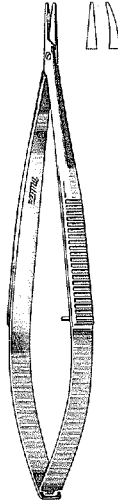

18-1820
18-1824

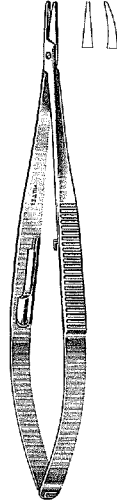

18-1828
18-1832

- 18-1800** KALT Needle Holder 5¼" (13.3 cm), standard model, delicate jaws
- 18-1810** GREEN Needle Holder and Suture Forceps 4¼" (10.8 cm), angled jaws, double end
- 18-1820** CASTROVIEJO Needle Holder 5½" (14 cm), straight, without lock
- 18-1824** CASTROVIEJO Needle Holder 5½" (14 cm), curved, without lock
- 18-1828** CASTROVIEJO Needle Holder 5½" (14 cm), straight, with lock
- 18-1832** CASTROVIEJO Needle Holder 5½" (14 cm), curved, with lock

For Carb-N-Sert Needle Holders with tungsten carbide inserts see pages 123 - 130

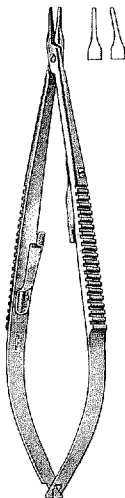

18-1831
18-1833

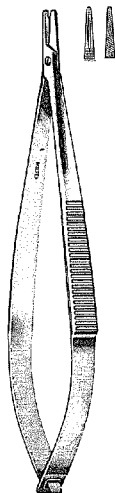

18-1834

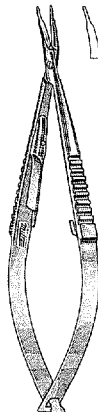

18-1837

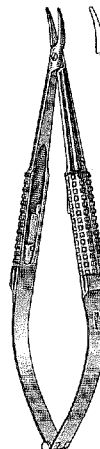

18-1838
18-1839

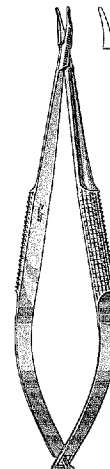

18-1840

- 18-1831 CASTROVIEJO Needle Holder 5½" (14 cm), extra delicate jaws, straight, with lock
- 18-1833 CASTROVIEJO Needle Holder 5½" (14 cm), extra delicate jaws, curved, with lock
- 18-1834 PATON Needle Holder 4½" (11.4 cm), straight, without lock
- 18-1837 McPHERSON Needle Holder for microsurgery 4" (10.2 cm), curved smooth tapered jaws
- 18-1838 BARRAQUER Needle Holder 5" (12.7 cm), curved, without lock, 10 mm wide hollow round handle
- 18-1839 BARRAQUER Needle Holder 5" (12.7 cm), curved, with lock, 10 mm wide hollow round handle
- 18-1840 BARRAQUER Needle Holder 4¾" (12.1 cm), curved, without lock, delicate tapered jaws, 8 mm wide round handle

For Carb-N-Sert Needle Holders with tungsten carbide inserts see pages 123 - 130

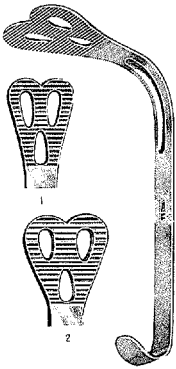

22-2
22-4



22-6

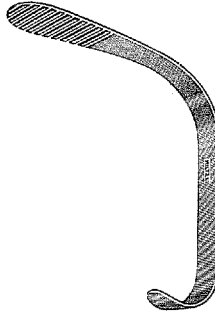

22-10



22-16

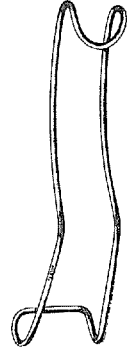

22-200

- 22-2 WIEDER Tongue Depressor, small blade 28 mm wide, serrated
- 22-4 WIEDER Tongue Depressor, large blade 36 mm wide, serrated
- 22-6 BOSWORTH Tongue Depressor, fenestrated blade 25 mm wide
- 22-10 ANDREWS Tongue Depressor, serrated blade 21 mm wide
- 22-16 Tongue Depressor 6 $\frac{3}{4}$ " (17.1 cm), double end, 20 mm and 25 mm wide, cross serrated
- 22-200 MILTEX Lip Retractor 6" (15.2 cm), double end 25 mm and 36 mm wide
- 22D-202 COLUMBIA Lip Retractor 5 $\frac{1}{2}$ " (14 cm), double end 35 mm and 50 mm wide
- 22D-209 UNIVERSITY OF MINNESOTA Cheek Retractor 5 $\frac{1}{2}$ " (14 cm), double end 14 mm and 20 mm wide

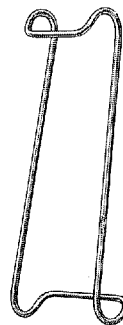

22D-202



22D-209

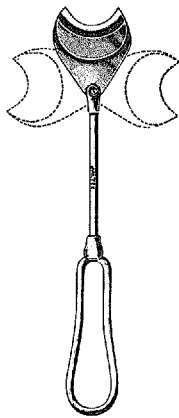

22-210

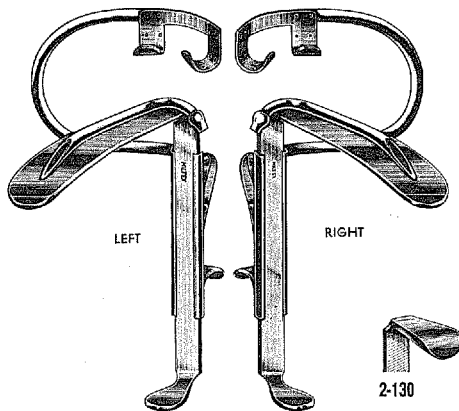

LEFT

RIGHT

2-130

2-120 to 2-122
2-132 to 2-138A

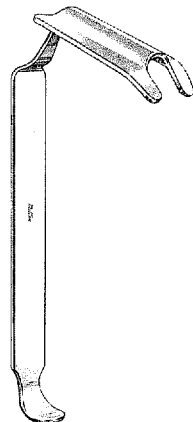

2-140 to 2-147

- 22-210** Cheek Retractor 7 $\frac{3}{4}$ " (19.7 cm), with swivel blade 35 mm wide
- 2-120** DAVIS Mouth Gag 6 $\frac{1}{4}$ " (15.9 cm), double bite, left, without blades
- 2-122** DAVIS Mouth Gag 6 $\frac{1}{4}$ " (15.9 cm), double bite, right, without blades

BLADES FOR DAVIS OR McIVOR MOUTH GAGS

W/o Ether Tube	Size No.	Size		W/Ether Tube
2-130	1	$\frac{3}{4}$ " x 1"	(1.9 x 2.5 cm)	—
2-132	2	1" x 2 $\frac{3}{4}$ "	(2.5 x 7 cm)	2-132A
2-134	3	1" x 3 $\frac{1}{4}$ "	(2.5 x 8.3 cm)	2-134A
2-136	4	1" x 3 $\frac{3}{4}$ "	(2.5 x 9.5 cm)	2-136A
2-138	5	1" x 4"	(2.5 x 10.2 cm)	2-138A

RING TONGUE RETRACTOR BLADES

For use with Davis or McIvor Mouth Gags.

Grooved blade holds endotracheal tube firmly in place.

Left	Size No.	Size		Right
2-140	2	$\frac{7}{8}$ " x 2 $\frac{1}{4}$ "	(2.2 x 5.7 cm)	2-144
2-141	3	1 $\frac{1}{8}$ " x 3"	(2.9 x 7.6 cm)	2-145
2-142	4	1 $\frac{1}{4}$ " x 3 $\frac{1}{2}$ "	(3.2 x 8.9 cm)	2-146
2-143	5	1 $\frac{1}{2}$ " x 3 $\frac{3}{4}$ "	(3.8 x 9.5 cm)	2-147

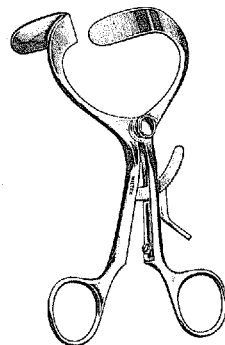

2-150

- 2-150** DOYEN-JANSEN Mouth Gag 5 $\frac{1}{2}$ " (14 cm), with grip lock

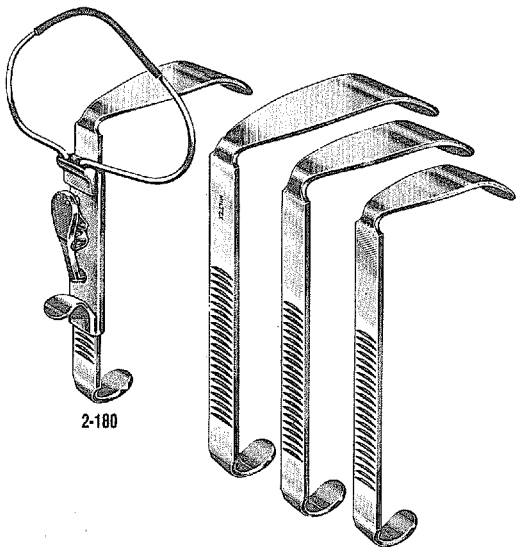

2-180

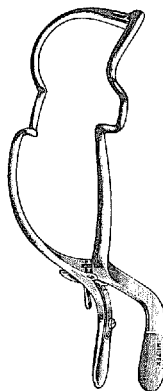

2-160 to 2-164

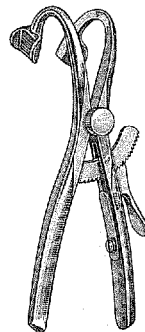

2-154

2-180 McIVOR Mouth Gag 5 $\frac{3}{4}$ " (14.6 cm), complete with 3 tongue blades, one each Nos. 2-132, 2-134 and 2-136.

2-182 McIVOR Mouth Gag 5 $\frac{3}{4}$ " (14.6 cm), frame only

2-160 JENNINGS Mouth Gag, adult size, 6" (15.2 cm) wide

2-162 JENNINGS Mouth Gag, child size, 4 $\frac{3}{4}$ " (12.1 cm) wide

2-164 JENNINGS Mouth Gag, infant size, 3 $\frac{3}{4}$ " (9.5 cm) wide

2-154 DENHARDT Mouth Gag 5 $\frac{3}{4}$ " (14.6 cm), improved model, with grip lock

MOLT Mouth Gags
with silicone guards

63-10 Pediatric 4" (10.2 cm)

63-15 Child 4 $\frac{1}{2}$ " (11.4 cm)

63-20 Adult 5 $\frac{1}{2}$ " (14 cm)

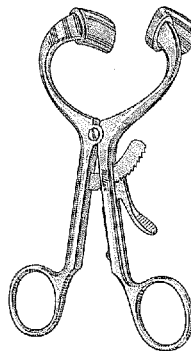

63-10 to 63-20



2-20

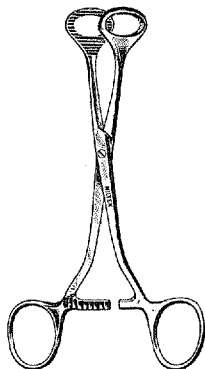

2-50

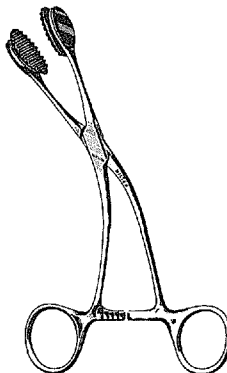

2-60
2-62



2-100

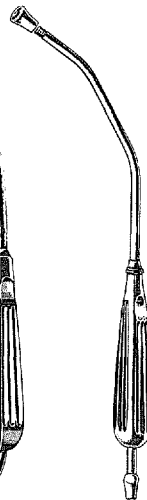

2-104
2-104SS

- 2-20 MAUNDER Oral Screw, white plastic
- 2-50 COLLIN Tongue Seizing Forceps 6¾" (17.1 cm), jaws 25 mm wide
- 2-60 YOUNG Tongue Seizing Forceps 6½" (16.5 cm), with soft rubber jaws
- 2-62 Rubber Jaws for YOUNG Tongue Forceps
- 2-100 PYNCHON Suction Tube 11" (27.9 cm), tip with large openings, with removable tubing connection, chrome
- 2-104 YANKAUER Suction Tube 11¾" (29.8 cm), with removable tip and tubing connection, chrome
- 2-104SS YANKAUER Suction Tube 11¾" (29.8 cm), with removable tip and tubing connection
- 2-106 Tip for YANKAUER Suction Tube, chrome
- 2-106SS Tip for YANKAUER Suction Tube
- 2-109 YANKAUER Pediatric Suction Tube 8½" (21.6 cm), with removable tip, delicate pattern



2-106
2-106SS

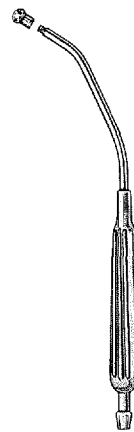

2-109

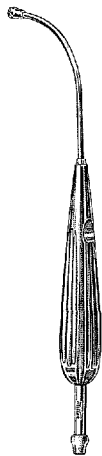

2-110
2-110SS

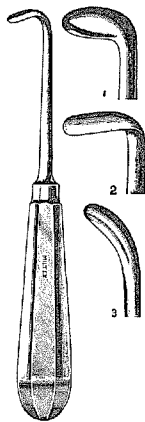

22-300 to 22-304



18-1968

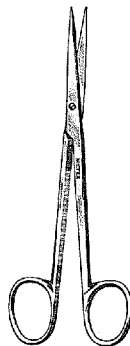

5-316

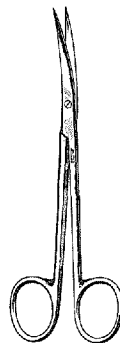

5-318
5D-326

- 2-110** ANDREWS-PYNCHON Suction Tube 10" (25.4 cm), delicate pattern, chrome
2-110SS ANDREWS-PYNCHON Suction Tube 10" (25.4 cm), delicate pattern
- 22-300** BLAIR Cleft Palate Elevator 7 $\frac{3}{4}$ " (19.7 cm), L-Shape, blunt
22-302 BLAIR Cleft Palate Elevator 7 $\frac{3}{4}$ " (19.7 cm), right angle, semi-sharp tip
22-304 BLAIR Cleft Palate Elevator 8" (20.3 cm), curved blade, blunt
- 18-1968** FREER Elevator 7" (17.8 cm), double end, sharp and blunt blades 5 mm wide
- 5-316** BROPHY Scissors 5 $\frac{1}{2}$ " (14 cm), straight, sharp points
5-318 BROPHY Scissors 5 $\frac{1}{2}$ " (14 cm), curved, sharp points
5D-326 BROPHY Scissors 5 $\frac{1}{2}$ " (14 cm), curved, one serrated blade
- 9-106** LONG Oral Surgery Stitch Scissors 6" (15.2 cm)

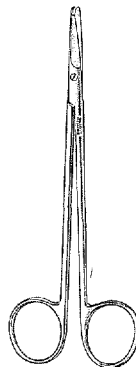

9-106

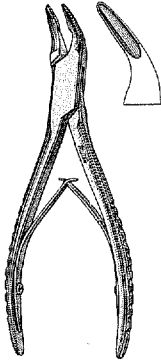

22D-420

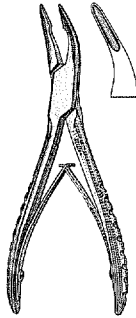

22D-422

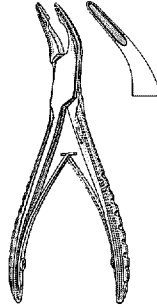

22D-424

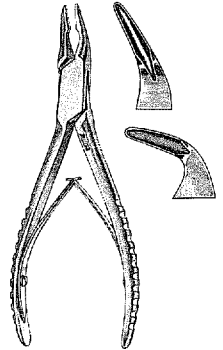

22-480 to 22-482

- 22D-420 BLUMENTHAL Oral Surgery Rongeur 6" (15.2 cm), beaks at 45° angle
- 22D-422 Mini-BLUMENTHAL Oral Surgery Rongeur 4½" (11.4 cm), beaks at 30° angle
- 22D-424 Mini-BLUMENTHAL Oral Surgery Rongeur 4½" (11.4 cm), beaks at 45° angle
- 22-480 BLUMENTHAL Oral Surgery Rongeur 6" (15.2 cm), beaks at 30° angle
- 22-481 BLUMENTHAL Oral Surgery Rongeur 7" (17.8 cm), beaks at 30° angle
- 22-482 BLUMENTHAL Oral Surgery Rongeur 6" (15.2 cm), beaks at 90° angle
- 22-484 MEAD Oral Surgery Rongeur 6½" (16.5 cm), No. 1A pattern, slightly angled beaks

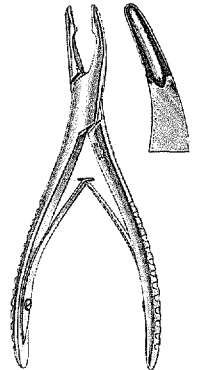

22-484

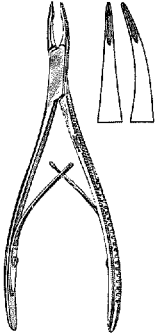

17-4800
17-4801

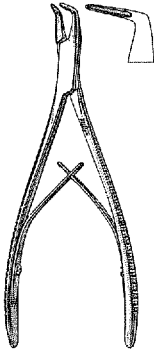

17D-4802

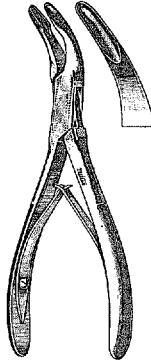

19-804

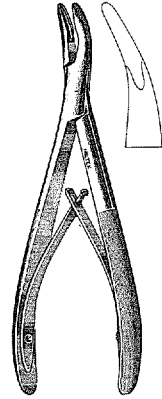

19-808

- 17-4800 Micro-FRIEDMAN Rongeur 5½" (14 cm), straight 1.3 mm wide jaws, very delicate
- 17-4801 Micro-FRIEDMAN Rongeur 5½" (14 cm), curved 1.3 mm wide jaws, very delicate
- 17D-4802 Micro-FRIEDMAN Rongeur 5½" (14 cm), 90° angled 1.3 mm wide jaws, very delicate
- 19-804 HARTMAN Rongeur 5¾" (14.6 cm), strong curve
- 19-808 BANE Rongeur 7" (17.8 cm), slight curve
- 19-844 BEYER Rongeur, double action, 7" (17.8 cm), slight curve
- 22-494 FRIEDMAN Oral Surgery Rongeur 5½" (14 cm), very delicate, slightly curved beaks

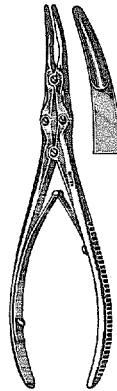

19-844

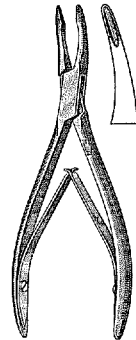

22-494

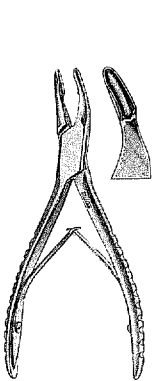

22-486
22-488

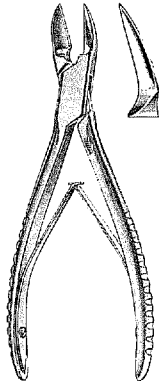

22-490

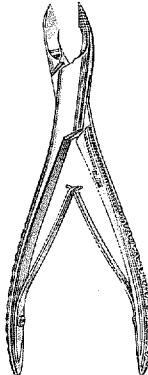

22D-426

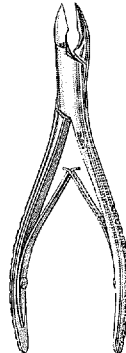

22D-428

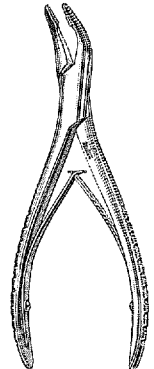

22D-432

- 22-486 Oral Surgery Rongeur 5 1/2" (14 cm), No. 4 pattern, slightly curved beaks
- 22-488 Oral Surgery Rongeur 6 1/2" (16.5 cm), No. 4A pattern, slightly curved beaks
- 22-490 Oral Surgery Rongeur 6 3/8" (17.1 cm), No. 5 pattern, side cutting, slightly curved
- 22D-426 Oral Surgery Rongeur 6 1/2" (16.5 cm), No. 5A pattern, side cutting, slightly curved
- 22D-428 Oral Surgery Rongeur 6" (15.2 cm), No. 5S pattern, side cutting, slightly curved
- 22D-432 Oral Surgery Rongeur 6 1/2" (16.5 cm), No. 1 pattern, strong curved beaks
- 22-492 Oral Surgery Rongeur 6 1/2" (16.5 cm), No. 6A pattern, end cutting, curved beaks

- 22-500TC Wire Twister 6" (15.2 cm), with Carb-N-Sert jaws
- 22-502TC Wire Twister 8" (20.3 cm), with Carb-N-Sert jaws

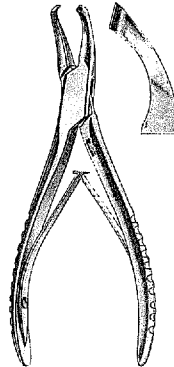

22-492

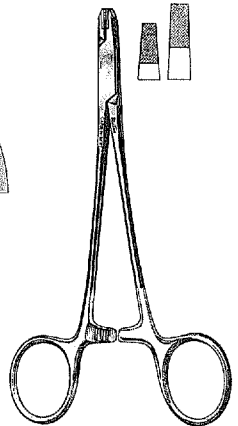

22-500TC
22-502TC

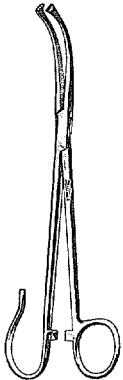

22-550
22-552

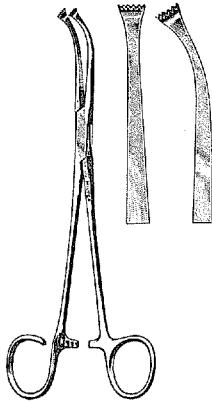

22-556
22-558

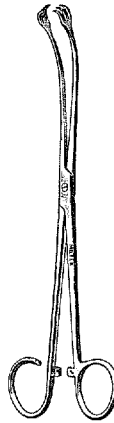

22-560

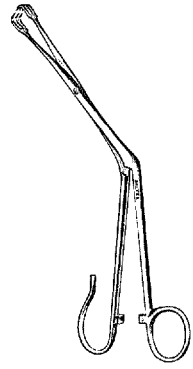

22-586

- 22-550 WHITE Tonsil Seizing Forceps 7½" (19.1 cm), medium curve, open ring
- 22-552 WHITE Tonsil Seizing Forceps 9½" (24.1 cm), medium curve, open ring
- 22-556 COLVER Tonsil Seizing Forceps 7½" (19.1 cm), straight, open ring
- 22-558 COLVER Tonsil Seizing Forceps 7½" (19.1 cm), medium curve, open ring
- 22-560 BALLENGER Tonsil Seizing Forceps 8½" (21.6 cm), slight curve, 3 x 3 prongs, open ring
- 22-586 TIVNEN Tonsil Seizing Forceps 8" (20.3 cm), angled 3 x 3 prongs, open ring

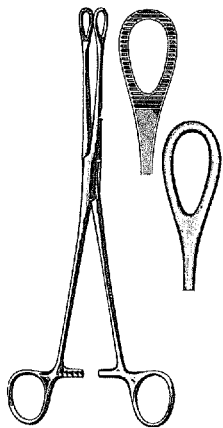

7-604
7-606

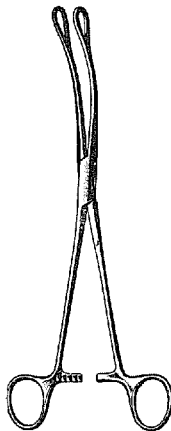

7-614
7-616

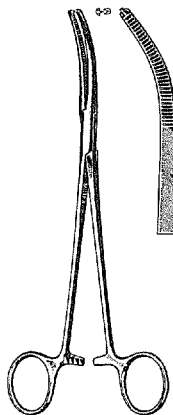

7-190

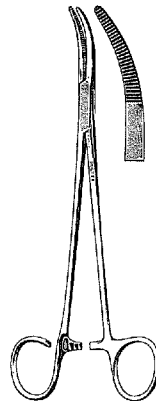

22-660

- 7-604 BALLENGER Sponge Forceps 7" (17.8 cm), straight, serrated loop jaws
- 7-606 BALLENGER Sponge Forceps 7" (17.8 cm), straight, smooth loop jaws
- 7-614 BALLENGER Sponge Forceps 7" (17.8 cm), curved, serrated loop jaws
- 7-616 BALLENGER Sponge Forceps 7" (17.8 cm), curved, smooth loop jaws
- 7-190 MICULICZ Tonsil Hemostatic Forceps 7½" (19.1 cm), slight curve, 1 x 2 teeth
- 22-660 SCHNIDT Tonsil Hemostatic Forceps 7½" (19.1 cm), slight curve, open ring
- 22-662 SCHNIDT Tonsil Hemostatic Forceps 7½" (19.1 cm), slight curve, closed rings

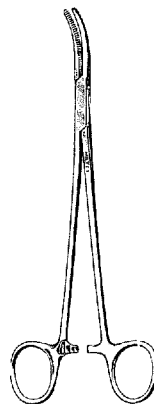

22-662

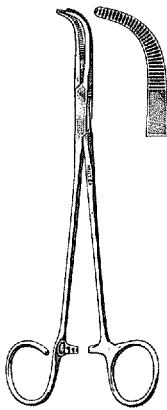

22-666

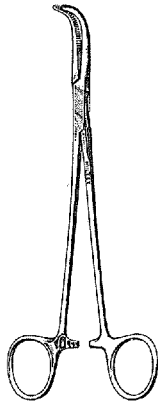

22-668



2-100



2-104
2-104SS



2-106
2-106SS

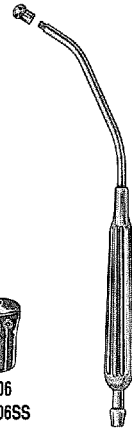

2-109

- 22-666 SAWTELL Tonsil Hemostatic Forceps 7½" (19.1 cm), full curve, open ring
- 22-668 SAWTELL Tonsil Hemostatic Forceps 7½" (19.1 cm), full curve, closed rings
- 2-100 PYNCHON Suction Tube 11" (27.9 cm), tip with large openings, with removable tubing connection, chrome
- 2-104 YANKAUER Suction Tube 11¾" (29.8 cm), with removable tip and tubing connection, chrome
- 2-104SS YANKAUER Suction Tube 11¾" (29.8 cm), with removable tip and tubing connection
- 2-106 Tip for YANKAUER Suction Tube, chrome
- 2-106SS Tip for YANKAUER Suction Tube
- 2-109 YANKAUER Pediatric Suction Tube 8½" (21.6 cm), with removable tip, delicate pattern
- 2-110 ANDREWS-PYNCHON Suction Tube 10" (25.4 cm), delicate pattern, chrome
- 2-110SS ANDREWS-PYNCHON Suction Tube 10" (25.4 cm), delicate pattern



2-110
2-110SS

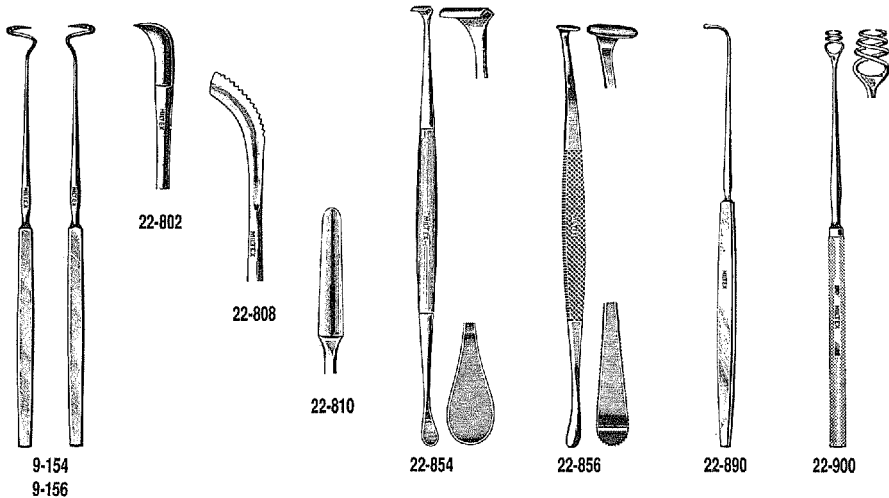

- 9-154 DUPUYS-WEISS Ligature Needle 8½" (21.6 cm), right
- 9-156 DUPUYS-WEISS Ligature Needle 8½" (21.6 cm), left
- 22-802 CANFIELD Tonsil Knife 8½" (21.6 cm), curved
- 22-808 FISHER Tonsil Knife and Dissector 8½" (21.6 cm), sharp tip
- 22-810 DEAN Tonsil Knife 7½" (19.1 cm), straight, double edge
- 22-854 HURD Tonsil Dissector and Pillar Retractor 9" (22.9 cm), standard pattern,
9 x 25 mm blade
- 22-856 MORRISON-HURD Tonsil Dissector and Pillar Retractor 9" (22.9 cm), flat handle,
8 x 25 mm serrated blade
- 22-890 COLVER Tonsil Examining Retractor 8" (20.3 cm), blunt tip
- 22-900 LEWIS Tonsil Screw 7¾" (19.7 cm), two sharp points, standard small size

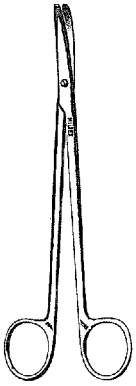

5-182



5-288



22-962

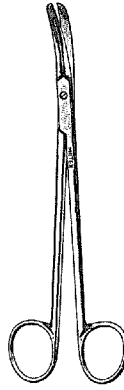

5-256

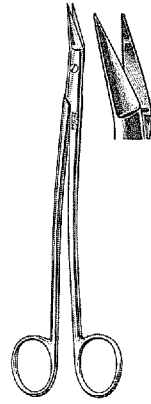

5-264

- 5-182 METZENBAUM Tonsil Scissors 7" (17.8 cm), curved, standard pattern
- 5-288 METZENBAUM Tonsil Scissors 7" (17.8 cm), curved, delicate pattern
- 22-962 LILLY Tonsil Scissors 7½" (19.1 cm), strong curve
- 5-256 BOETTCHER Tonsil Scissors 7¼" (18.4 cm), curved
- 5-264 DEAN Tonsil Scissors 6¾" (17.1 cm), blades angled on flat, one serrated blade

For Carb-N-Sert and SuperCut Metzenbaum Scissors see pages 57 and 61.

Tonsil Instruments

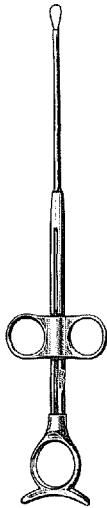

22-1000

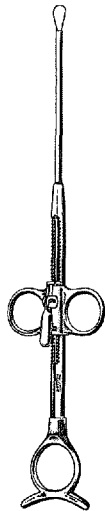

22-1002

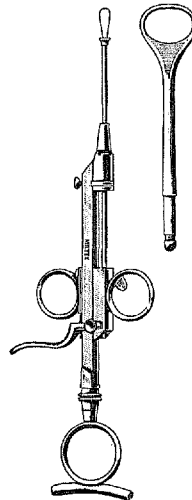

22-1010 to 22-1020

- 22-1000** EVE Tonsil Snare 11" (27.9 cm), standard model, without ratchet
- 22-1002** EVE Tonsil Snare 11" (27.9 cm), with ratchet
- 22-1010** BECK-SCHENCK Tonsil Snare 10" (25.4 cm), complete with one straight and one vedder tip
- 22-1016** Medium Vedder Tip, opening 23 x 19 mm
- 22-1020** Straight Tip 2 1/2" (6.4 cm) for BECK-SCHENCK Tonsil Snare
- 22-1030** SAGE Automatic Ratchet Tonsil Snare, improved pattern, with removable straight tip

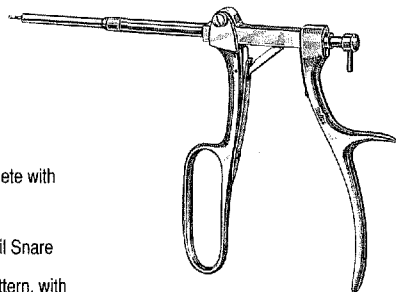

22-1030

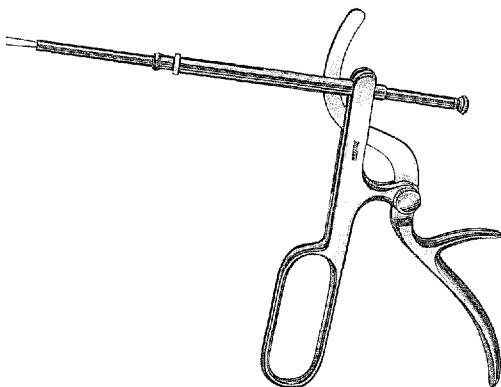

22-1041
22-1042

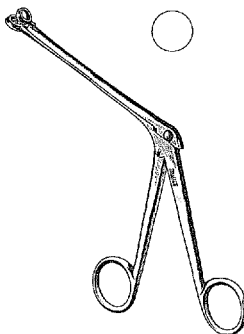

22-1052 **22-1060**

22-1041 TYDING Tonsil Snare, complete with straight tip
22-1042 Straight Tip for TYDING Snare

22-1052 HARTMAN Tonsil Punch, 4½" (11.4 cm) shaft, 9 mm round cut, with basket

*TONSIL SNARE WIRE,
 pre-cut 4" (10.2 cm), bent ends

22-1060-6 Size 6 **22-1060-8** size 8

22-1060-7 Size 7 **22-1060-9** size 9

22-1070 BROWN Tonsil Snare, complete with one straight and one vedder tip

22-1072 Straight tip for BROWN Snare

22-1074 Vedder Tip 23 x 19 mm opening, for BROWN Snare

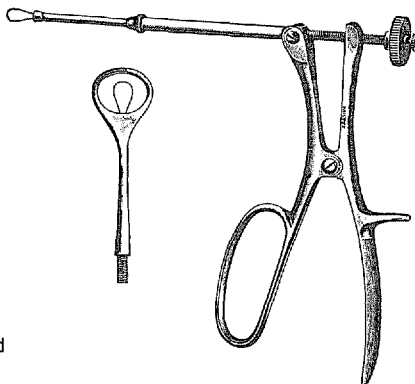

22-1070 to 22-1074

*For Snare Wire Sizes 4 and 5 see page 294



23-1 to 23-18

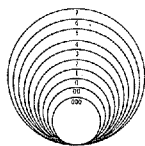

23-1 to 23-46



23-29 to 23-46

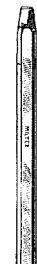

23-60



23-62

LARYNGEAL MIRRORS, Boitable, Thin Model

Complete with octagon threaded handle	Size No.	Diameter	Mirror only with threaded stem
23-1-000	000	10 mm	23-29-000
23-2-00	00	12 mm	23-30-00
23-4-0	0	14 mm	23-32-0
23-6-1	1	16 mm	23-34-1
23-8-2	2	18 mm	23-36-2
23-10-3	3	20 mm	23-38-3
23-12-4	4	22 mm	23-40-4
23-14-5	5	24 mm	23-42-5
23-16-6	6	26 mm	23-44-6
23-18-7	7	28 mm	23-46-7

23-60 Octagon Threaded Handle for Laryngeal Mirrors

23-62 UNIVERSAL Chuck Handle for Laryngeal Mirrors, round, chrome

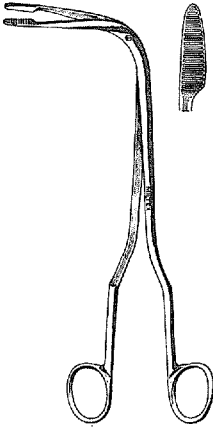

23-150

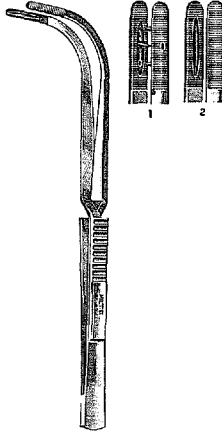

23-160
23-162



23-200

23-150 FRAENKEL Laryngeal Forceps 9" (22.9 cm), serrated jaws

23-160 JACKSON Laryngeal Forceps 9½" (24.1 cm), cross action, serrated jaws with 1 x 2 teeth, 3 mm wide

23-162 JACKSON Laryngeal Forceps 9½" (24.1 cm), cross action, serrated jaws 3 mm wide

23-200 IVAN Laryngeal Applicator 8½" (21.6 cm), curved, triangular end

23-230 FRAENKEL Laryngeal Forceps 9" (22.9 cm), alligator type, lower jaw opening, 12 x 3 mm cups

23-232 FRAENKEL Laryngeal Forceps 9" (22.9 cm), alligator type, jaw opening to right side, 12 x 3 mm cups

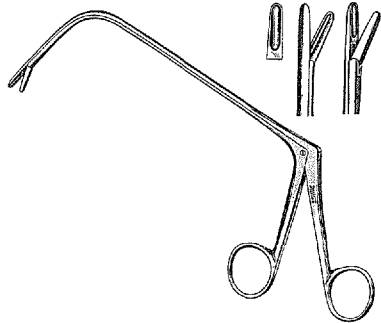

23-230
23-232

Laryngeal Instruments

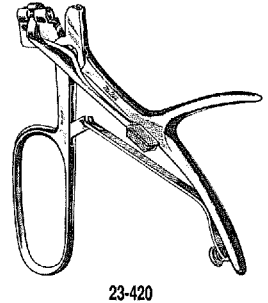
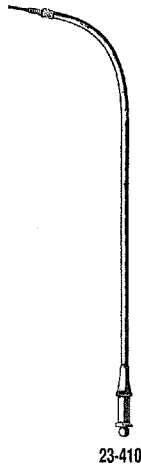
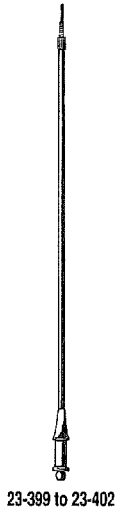
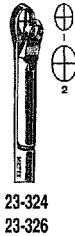
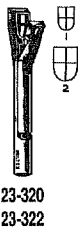

UNIVERSAL LARYNGEAL TIPS for use with
Nos. 23-399 to 23-410 Cannula and No. 23-420 Handle

23-282 BRUENING Cup Jaws, 3 mm round, straight

23-286 Cup Jaws, 3 mm round, angled-up.

23-320 KRAUSE Square Basket Jaws, through-cutting, small, straight

23-322 KRAUSE Square Basket Jaws, through-cutting, large, straight

23-324 KRAUSE Oval Basket Jaws, through-cutting, small, straight

23-326 KRAUSE Oval Basket Jaws, through-cutting, large, straight

UNIVERSAL CANNULA for use with
Laryngeal Tips and Universal Handles

23-399 15 cm straight

23-400 20 cm straight

23-402 30 cm straight

23-410 20 cm curved

23-420 UNIVERSAL Handle for use with all Cannula and Tips



Bronchial and Esophageal Instruments



23-600

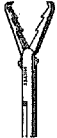

23-622



23-640 to 23-644
23-804



23-650



23-680 to 23-690



23-720

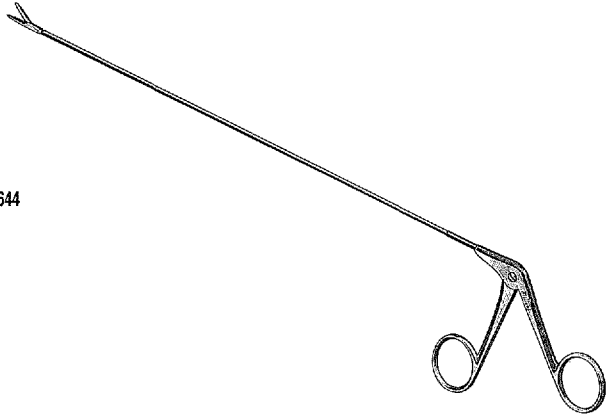

23-600 to 23-804

BRONCHOSCOPIC FORCEPS Double Articulated Jaws

- | | |
|--------|---|
| 23-600 | Serrated Grasping Jaws, 30 cm shaft, 4 mm pass diameter |
| 23-622 | KAHLER Alligator Grasping Jaws, 40 cm shaft, 4 mm pass diameter |
| 23-640 | Serrated Jaws 3 x 12 mm, 30 cm shaft, 4 mm pass diameter |
| 23-642 | Serrated Jaws 3 x 12 mm, 40 cm shaft, 4 mm pass diameter |
| 23-644 | Serrated Jaws 3 x 12 mm, 50 cm shaft, 4 mm pass diameter |
| 23-650 | Papilloma Grasping Jaws 7 mm wide, with fine serrations, 30 cm shaft |
| 23-680 | JACKSON Cup Jaws 2 mm dia. straight, 30 cm shaft |
| 23-690 | JACKSON Cup Jaws 4 mm dia. straight, 30 cm shaft |
| 23-720 | JACKSON Cup Jaws 4 mm dia. angular, 30 cm shaft |
| 23-804 | Serrated Jaws 2 x 8 mm, Miniature size, 20 cm shaft, 3 mm pass diameter |

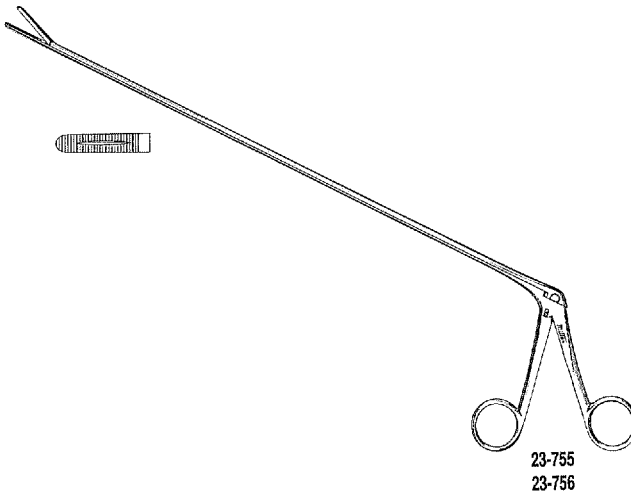

JACKSON ENDOSCOPIC FORCEPS, Standard Pattern

- 23-755** Serrated Grasping Jaws 4 x 20 mm, 30 cm shaft, passes 5 mm tube
- 23-756** Serrated Grasping Jaws 4 x 20 mm, 30 cm shaft, passes 5 mm tube



23-1047



23-1048



23-1049



23-1050



23-1051

- 23-1047** LUKENS Trachea Retractor 6 $\frac{3}{4}$ " (17.1 cm), 10 mm wide curved and 7 mm wide angular blades
- 23-1048** HUPP Trachea Hook 6 $\frac{1}{2}$ " (16.5 cm), sharp point
- 23-1049** JACKSON Trachea Retractor 7" (17.8 cm), double end, 2 blunt prongs $\frac{5}{16}$ " (2.4 cm) wide, and solid blade $\frac{3}{8}$ " (1 cm) wide
- 23-1050** JACKSON Trachea Tenaculum 5 $\frac{3}{4}$ " (14.6 cm), sharp point
- 23-1051** NEWS Tracheotomy Hook 6" (15.2 cm), sharp point

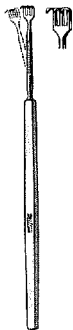

11D-27

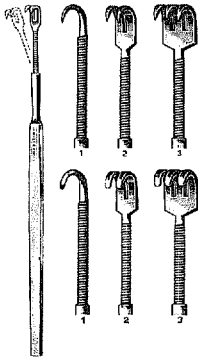

11-30 to 11-40

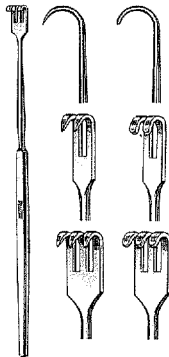

11-50 to 11-60



11-73

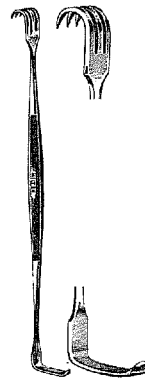

11-74
11-76

11D-27 Trachea Retractor 5" (12.7 cm), with Flexible Neck, 3 sharp prongs

TRACHEA RETRACTORS 6" (15.2 cm), with Flexible Neck

11-30	Sharp	1 Prong	11-36	Blunt
11-32	Sharp	2 Prongs	11-38	Blunt
11-34	Sharp	3 Prongs	11-40	Blunt

TRACHEA RETRACTORS 6" (15.2 cm), with Rigid Neck

11-50	Sharp	1 Prong	11-56	Blunt
11-52	Sharp	2 Prongs	11-58	Blunt
11-54	Sharp	3 Prongs	11-60	Blunt

11-73 RAGNELL Retractor 6" (15.2 cm), double end 3 x 8 mm and 5 x 15 mm blades, delicate

11-74 SENN Retractor 6 3/4" (16.2 cm), sharp, double end

11-76 SENN Retractor 6 3/4" (16.2 cm), blunt, double end

11-80 MATHIEU Retractor 6 1/2" (16.5 cm), sharp, double end

11-81 MATHIEU Retractor 6 1/2" (16.5 cm), blunt, double end

11-82 MEYERDING Skin Hook and Retractor 6 1/4" (15.9 cm), double end



11-80
11-81



11-82



23-1060



23-1402

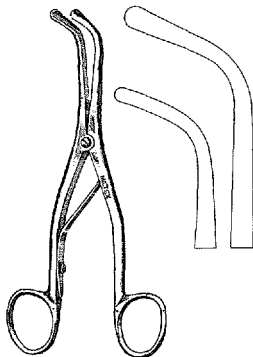

23-1420
23-1421

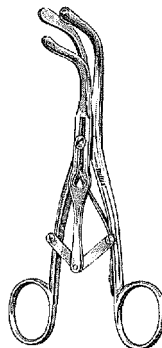

23-1430

23-1060 JACKSON Trachea Bistouri 6½" (16.5 cm), curved blade 2" (5.1 cm), long, with probe tip

23-1402 MOSHER Life Saving Tube 8" (20.3 cm) size 20 Fr. (6.6 mm)

23-1420 TROUSSEAU Trachea Dilator 5¼" (13.3 cm), standard size, jaws 3 cm long x 5 mm wide at tip

23-1421 TROUSSEAU Trachea Dilator 4½" (11.4 cm), neo natal size, jaws 2 cm long x 3 mm wide at tip

23-1430 LaBORDE Trachea Dilator 5½" (14 cm), three bladed

T Tracheal Instruments



Size	Actual Size	O.D. mm	Cat. No. 23-1139SS to 23-1219SS	Cat. No. 23-1243SS to 23-1251SS	Cat. No. 23-1350SS to 23-1352SS	Cat. No. 23-1360ST and 23-1361ST
00		4	1-5/16" (33mm)			
0		5	1-1/2" (38mm)			
1		5.5	1-3/4" (44mm)			
2		6	2" (51mm)	1-3/4" (44mm)		
3		7	2-9/32" (58mm)	1-7/8" (48mm)		
4		8	2-7/16" (62mm)	2-1/16" (52mm)		
5		9	2-5/8" (68mm)	2-3/16" (56mm)		
6		10	2-11/16" (69mm)	2-3/16" (56mm)		
7		11	2-11/16" (69mm)	2-3/16" (56mm)		2-5/32" (55mm)
8		12	2-11/16" (69mm)	2-3/16" (56mm)	1-5/8" (42mm)	2-5/32" (55mm)
9		13	2-11/16" (69mm)	2-3/16" (56mm)		
10		14	2-11/16" (69mm)	2-3/16" (56mm)	1-5/8" (42mm)	
12		16			1-5/8" (42mm)	

Length in inches and millimeters measured on inside curve

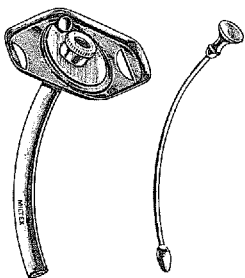

23-1139 to 23-1159

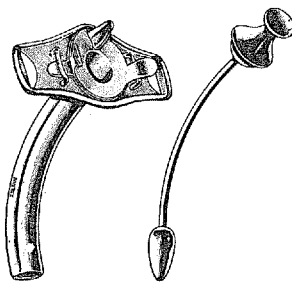

23-1199 to 23-1251

JACKSON TRACHEA TUBES, Improved Model with Rotating Lock

23-1139SS	Size 00	23-1150SS	Size 5
23-1140SS	Size 0	23-1152SS	Size 6
23-1142SS	Size 1	23-1154SS	Size 7
23-1144SS	Size 2	23-1156SS	Size 8
23-1146SS	Size 3	23-1158SS	Size 9
23-1148SS	Size 4	23-1159SS	Size 10

JACKSON TRACHEA TUBES, Regular Length, Original Model with Wing Lock

23-1199SS	Size 00	23-1210SS	Size 5
23-1200SS	Size 0	23-1212SS	Size 6
23-1202SS	Size 1	23-1214SS	Size 7
23-1204SS	Size 2	23-1216SS	Size 8
23-1206SS	Size 3	23-1218SS	Size 9
23-1208SS	Size 4	23-1219SS	Size 10

JACKSON TRACHEA TUBES, Short Length, Original Model with Wing Lock

23-1243SS	Size 2	23-1248SS	Size 7
23-1244SS	Size 3	23-1249SS	Size 8
23-1245SS	Size 4	23-1250SS	Size 9
23-1246SS	Size 5	23-1251SS	Size 10
23-1247SS	Size 6		

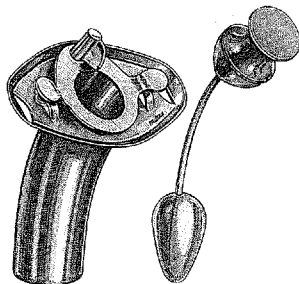

23-1350 to 23-1352

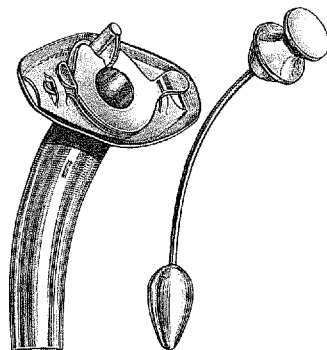

23-1360
23-1361

- 23-1350SS MARTIN Laryngectomy Tube, Size 8
- 23-1351SS MARTIN Laryngectomy Tube, Size 10
- 23-1352SS MARTIN Laryngectomy Tube, Size 12
- 23-1360ST LEWIS Laryngectomy Tube, Size 7, tapered, sterling
- 23-1361ST LEWIS Laryngectomy Tube, Size 8, tapered, sterling

CLEANING BRUSHES for Trachea and Laryngectomy Tubes
Nylon Bristles with Stainless Wire Handles

- 23-1600 Small Brush for tube sizes 2 to 5, overall length 6" (15.2 cm)
- 23-1602 Large Brush for tube sizes 6 to 12, overall length 8" (20.3 cm)

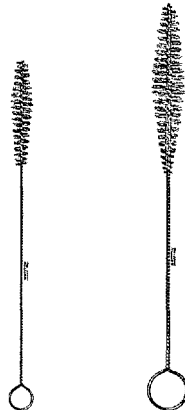

23-1600

23-1602

Enlarged cross sections of our basic patterns:

DeBakey type serration

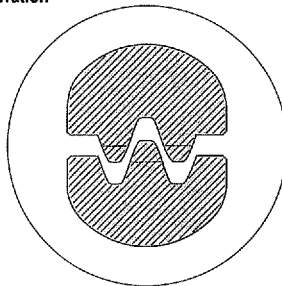
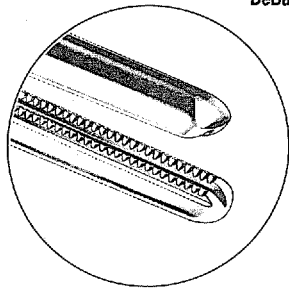

Cooley type serration

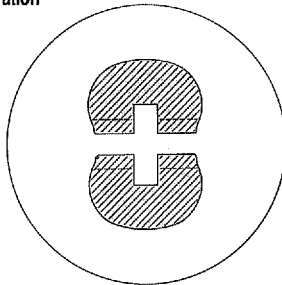
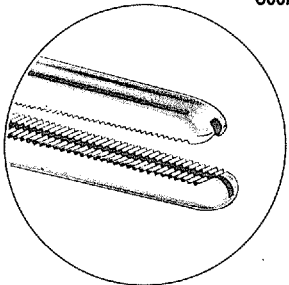

Manufactured in the Miltex tradition, these high quality instruments feature:

- Individual hand finishing assures soft spring action of the handles and perfect balance
- A scientific milling process produces an exclusive design on the atraumatic clamping surfaces, providing fine serrations that are of non-traumatic quality, but that will grip the tissue firmly
- Basic jaw types include the DeBakey type and the Cooley type

Atraumatic Forceps

Milux
XI

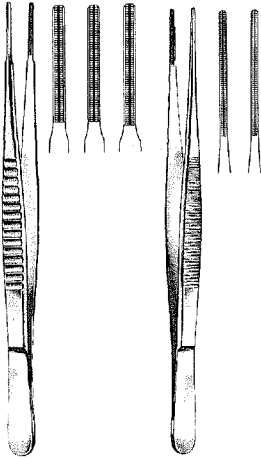

24-550 to 24-556

24-570 to 24-574

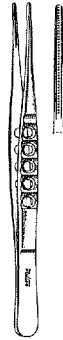

24-570XL



6-125

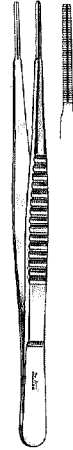

24-580
24-582

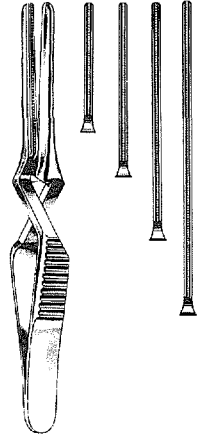

24-600 to 24-606

DeBAKEY THORACIC TISSUE FORCEPS, 2.5 mm wide tips

24-550	6" (15.2 cm)	24-554	9½" (24.1 cm)
24-552	7½" (19.7 cm)	24-556	12" (30.5 cm)

DeBAKEY VASCULAR TISSUE FORCEPS, 1.5 mm wide tips

24-570	6" (15.2 cm)
24-570XL	6" (15.2 cm), lightweight with fenestrated handles
24-572	8" (20.3 cm)
24-574	9½" (24.1 cm)

6-125 DeBAKEY-ADSON Tissue Forceps 4¾" (12.1 cm), 1.5 mm wide tips

24-580 COOLEY Vascular Tissue Forceps 6" (15.2 cm), tips 2 mm wide

24-582 COOLEY Vascular Tissue Forceps 8" (20.3 cm), tips 2 mm wide

DeBAKEY BULLDOG CLAMPS, Cross Action

Straight	Size	Tips	Curved
24-600	7.5 cm	2 cm	24-650
24-602	8.5 cm	3 cm	24-652
24-604	10.5 cm	4.5 cm	24-654
24-606	12 cm	6 cm	24-656

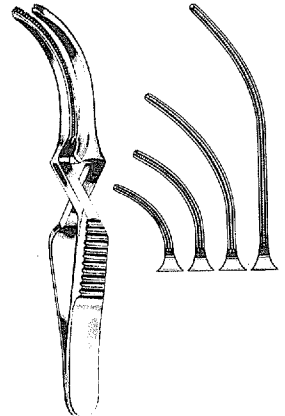

24-650 to 24-656

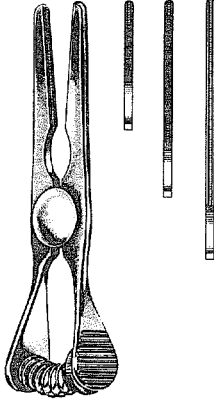

24-700 to 24-704

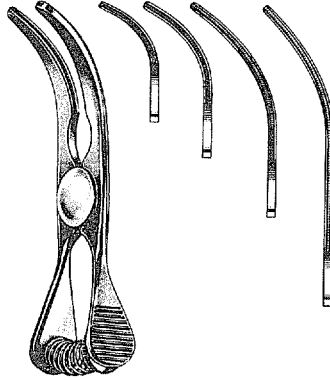

24-750 to 24-756

GLOVER BULLDOG CLAMPS, with Spring Tension Adjusting Screw

Straight	Size	Jaws	Curved
24-700	7 cm	2 cm	24-750
24-702	8 cm	2.5 cm	24-752
24-704	9 cm	4 cm	24-754
—	11 cm	6 cm	24-756

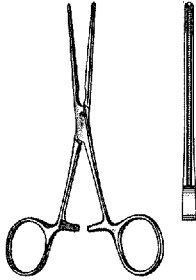

24-800

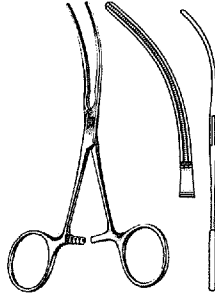

24-802

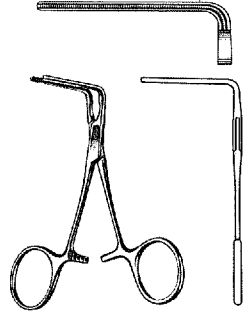

24-804

**DeBAKEY RING HANDLED
BULLDOG CLAMPS**

- 24-800 Straight 5" (12.7 cm)
- 24-802 Curved 4 $\frac{3}{4}$ " (12.1 cm)
- 24-804 90° Angle 4" (10.2 cm)
- 24-806 45° Angle 4 $\frac{7}{8}$ " (12.4 cm)
- 24-808 S-Curved 4 $\frac{3}{4}$ " (12.1 cm)

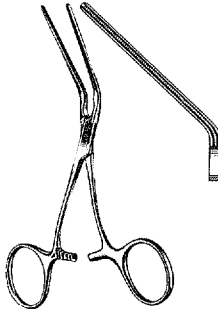

24-806

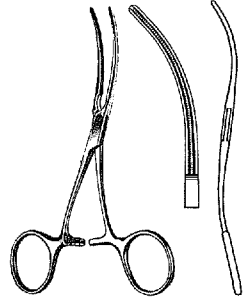

24-808



Atraumatic Forceps

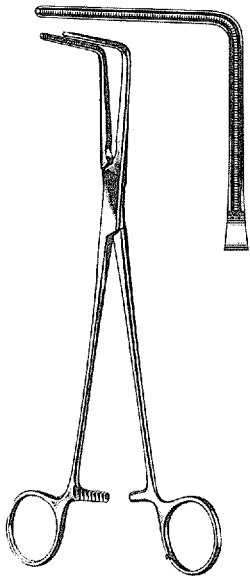

24-900

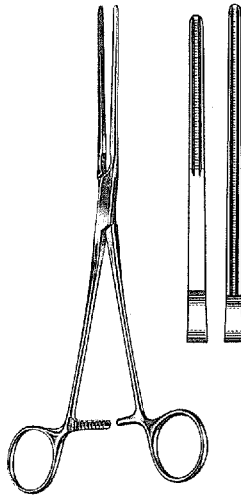

24-1000
24-1100

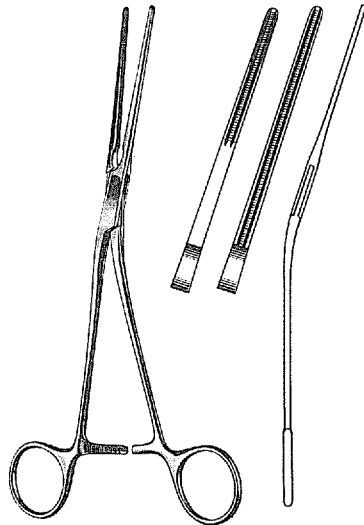

24-1002
24-1102

- 24-900 LEE Right Angle Bronchus and General Purpose Vascular Clamp 9" (22.9 cm)
- 24-1000 GLOVER Patent Ductus Clamp 8" (20.3 cm), straight, 3 cm jaws
- 24-1002 GLOVER Patent Ductus Clamp 8" (20.3 cm), angular, 3 cm jaws
- 24-1100 GLOVER Coarctation Clamp 8 $\frac{3}{4}$ " (22.2 cm), straight, 6 cm jaws
- 24-1102 GLOVER Coarctation Clamp 8 $\frac{3}{4}$ " (22.2 cm), angular, 6 cm jaws

Atraumatic Forceps

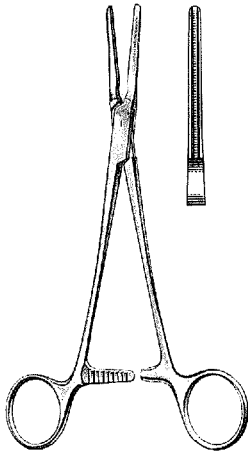

24-1150

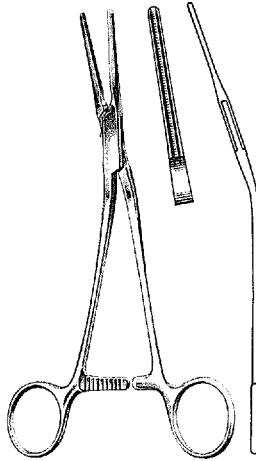

24-1152

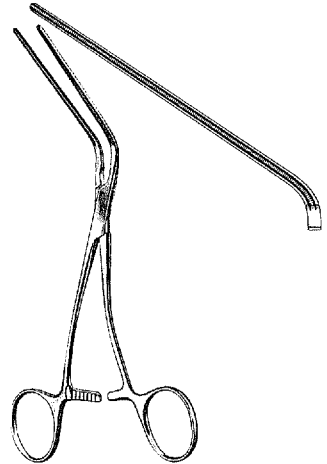

24-1180

- 24-1150 DeBAKEY Patent Ductus and Peripheral Vascular Clamp 8" (20.3 cm) straight, 3 cm jaws
- 24-1152 DeBAKEY Patent Ductus and Peripheral Vascular Clamp 8" (20.3 cm) angular, 3 cm jaws
- 24-1180 DeBAKEY Peripheral Vascular Clamp 7" (17.8 cm), angled jaws 6.5 cm
- 24-1190 DeBAKEY Peripheral Vascular Clamp 8" (20.3 cm), S-Shaped
- 24-1200 DeBAKEY Peripheral Vascular Clamp 6" (15.2 cm), curved jaws

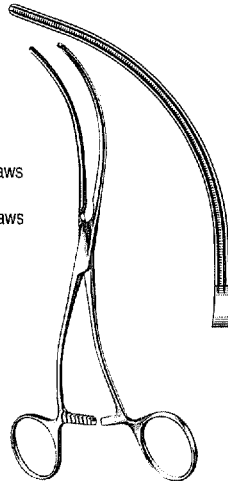

24-1190

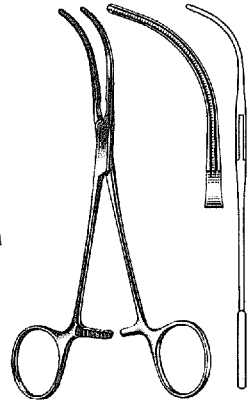

24-1200

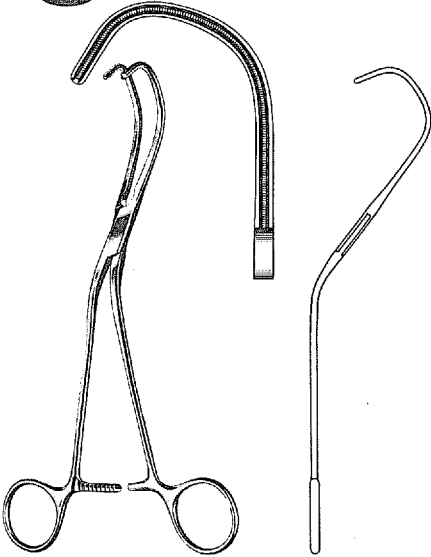

24-1250

24-1250 LAMBERT-KAY Vascular Clamp for Aortic Anastomosis 8" (20.3 cm), jaws 4.5 cm wide, 1.9 cm deep

24-1300 DeBAKEY-SEMB Ligature Carrier 10¼" (26 cm)

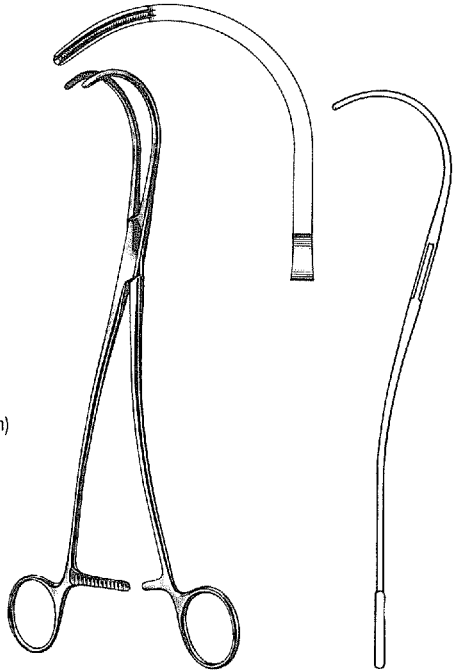

24-1300

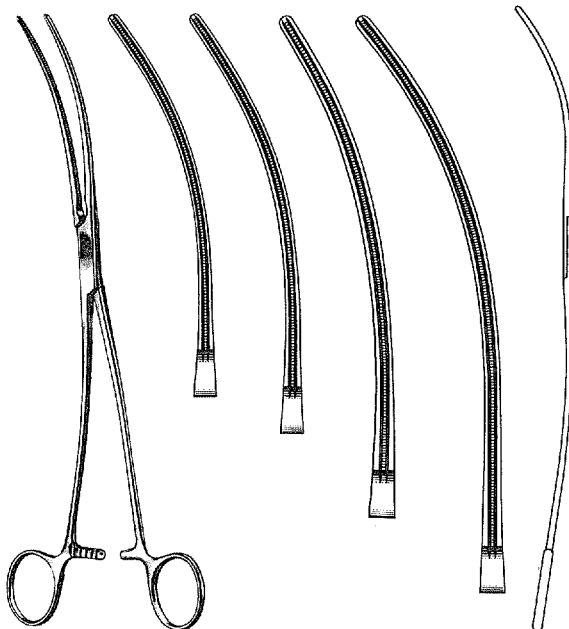

24-1400 to 24-1412

- 24-1400 DeBAKEY Vascular Clamp for Aortic Aneurism 10" (25.4 cm), slightly curved jaws 7.5 cm
- 24-1404 DeBAKEY Vascular Clamp for Aortic Aneurism 10½" (26.7 cm), slightly curved jaws 8.5 cm
- 24-1408 DeBAKEY Vascular Clamp for Aortic Aneurism 12¼" (31 cm), slightly curved jaws 10 cm
- 24-1412 DeBAKEY Vascular Clamp for Aortic Aneurism 12¾" (32.4 cm), slightly curved jaws 12 cm



Atraumatic Forceps

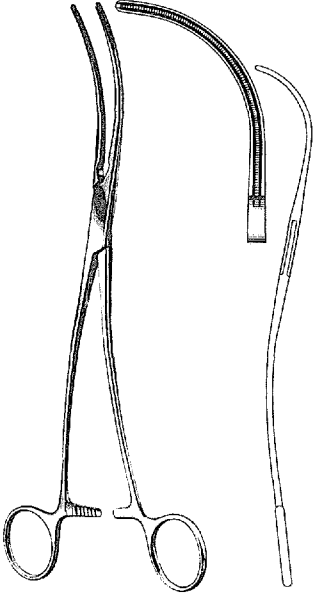

24-1500

24-1500 DeBAKEY Vascular Clamp for Aortic Aneurism 9½" (24.1 cm), strongly curved jaws

DeBAKEY MULTIPURPOSE CLAMPS,
OBTUSE ANGLE, 60°

24-1600 9½" (24.1 cm) long, 4 cm jaws

24-1602 8¾" (21 cm) long, 5 cm jaws

24-1604 9½" (24.1 cm) long, 6.5 cm jaws

24-1606 12" (30.5 cm) long, 10 cm jaws

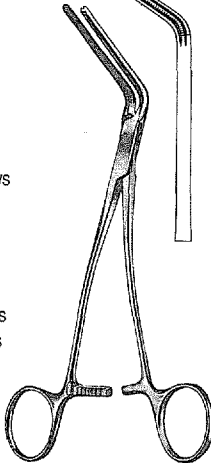
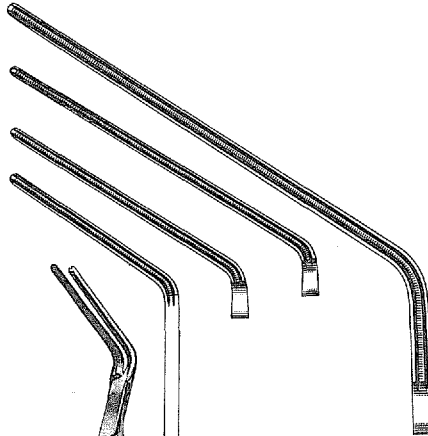

24-1600 to 24-1606

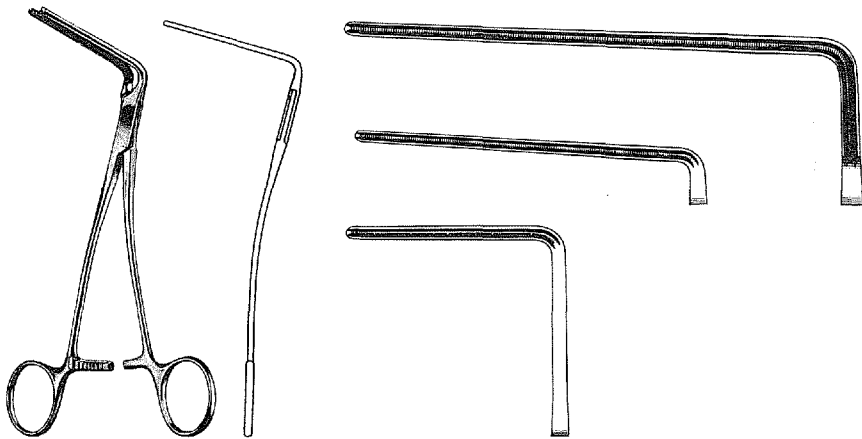

24-1650 to 24-1656

DeBAKEY MULTIPURPOSE CLAMPS, RIGHT ANGLE, 90°

24-1650	9" (22.9 cm) long,	4 cm jaws
24-1654	8" (20.3 cm) long,	6.5 cm jaws
24-1656	10½" (26.7 cm) long,	10 cm jaws

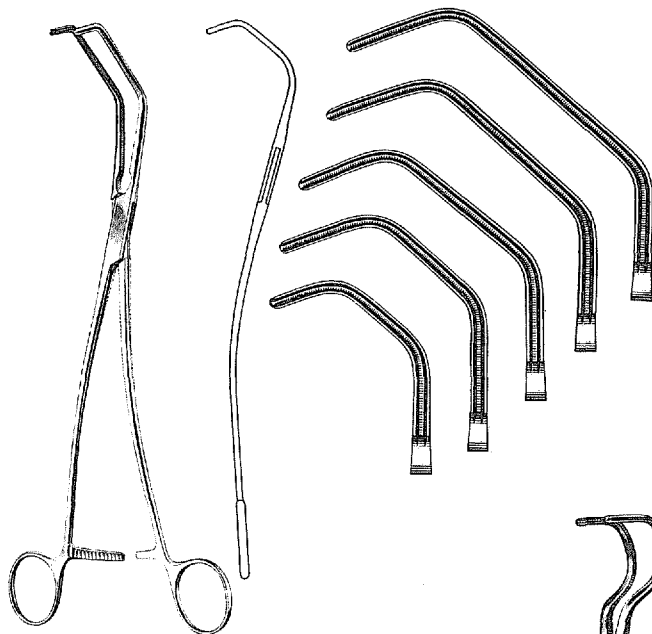

24-2000 to 24-2040

- 24-2000 DeBAKEY Tangential Occlusion Clamp 8" (20.3 cm)
- 24-2010 DeBAKEY Tangential Occlusion Clamp 10" (25.4 cm)
- 24-2020 DeBAKEY Tangential Occlusion Clamp 10¼" (26 cm)
- 24-2030 DeBAKEY Tangential Occlusion Clamp 10½" (26.7 cm)
- 24-2040 DeBAKEY Tangential Occlusion Clamp 11" (27.9 cm)
- 24-2050 WYLIE "J" Clamp 9" (22.9 cm), 3.3 cm wide x 2.5 cm deep jaws

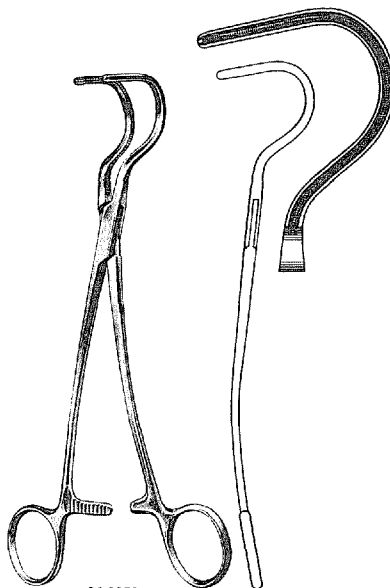

24-2050

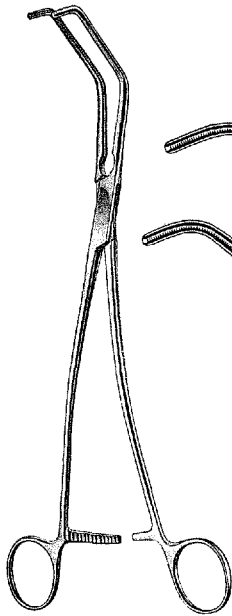

24-2100 to 24-2120

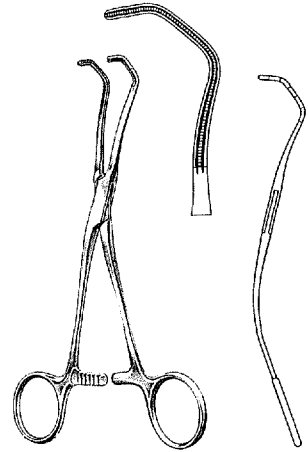
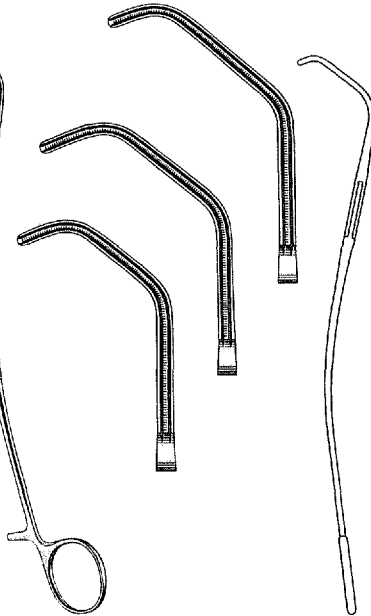

24-2500

- 24-2100** SATINSKY-DeBAKEY Vascular Clamp for Vena Cava 9 $\frac{3}{4}$ " (24.8 cm), small
- 24-2110** SATINSKY-DeBAKEY Vascular Clamp for Vena Cava 9 $\frac{3}{4}$ " (24.8 cm), medium
- 24-2120** SATINSKY-DeBAKEY Vascular Clamp for Vena Cava 9 $\frac{3}{4}$ " (24.8 cm), large
- 24-2500** COOLEY Pediatric Vascular Clamp for Anastomosis 6 $\frac{1}{2}$ " (16.5 cm), with 5mm graduations on jaws



Atraumatic Forceps

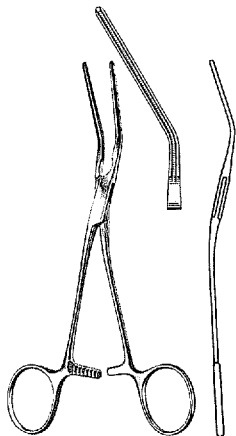

24-2700

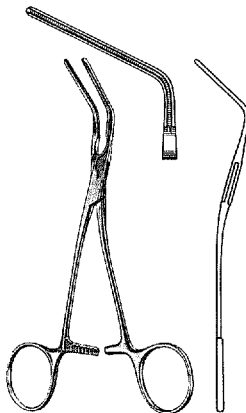

24-2710

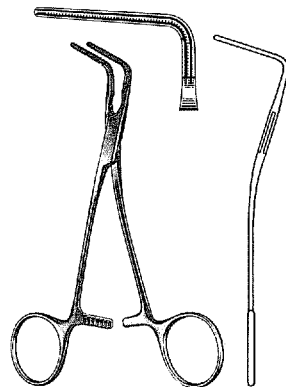

24-2720

- 24-2700 DeBAKEY Pediatric Multi-Purpose Clamp
6½" (16.5 cm), angled 30°
- 24-2710 DeBAKEY Pediatric Multi-Purpose Clamp
6" (15.2 cm), angled 60°
- 24-2720 DeBAKEY Pediatric Multi-Purpose Clamp
5½" (14 cm), angled 90°
- 24-2960 DeBAKEY-DERRA Vascular Clamp for
Anastomosis 6¼" (15.9 cm), small jaws
- 24-2961 DeBAKEY-DERRA Vascular Clamp for
Anastomosis 6¾" (17.1 cm), medium jaws
- 24-2962 DeBAKEY-DERRA Vascular Clamp for
Anastomosis 7" (17.8 cm), large jaws

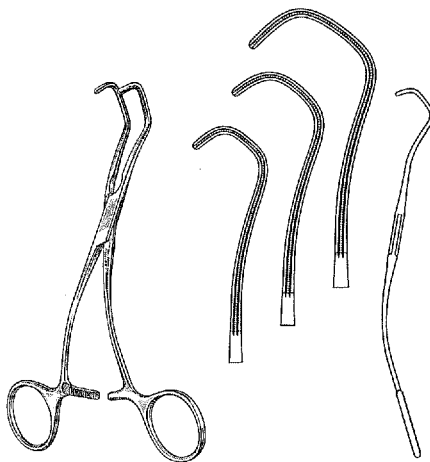

24-2960 to 24-2962

Atraumatic Forceps

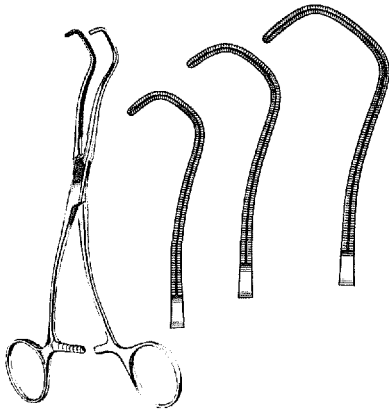

24-3000 to 24-3020

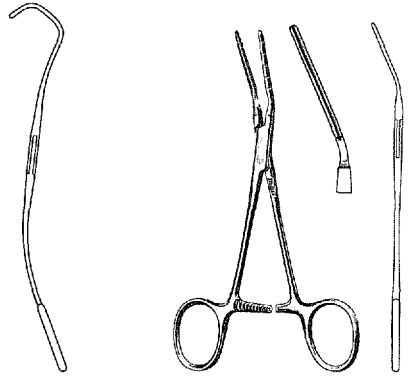

24-3200

COOLEY-DERRA Pediatric Vascular Clamps for Anastomosis 6½" (16.5 cm)

- 24-3000 small
- 24-3010 medium
- 24-3020 large

COOLEY Pediatric Vascular Clamps 5½" (14 cm)
5 mm calibrations on outer sides of jaws

- 24-3200 angled jaws 25 mm, straight handles
- 24-3210 straight jaws 25 mm, angled handles
- 24-3220 straight jaws 25 mm, straight handles

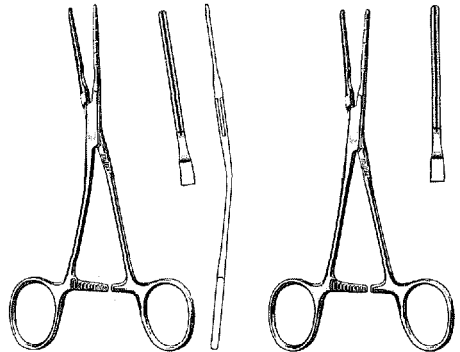

24-3210

24-3220

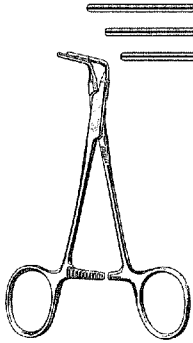

24-3230 to 24-3250

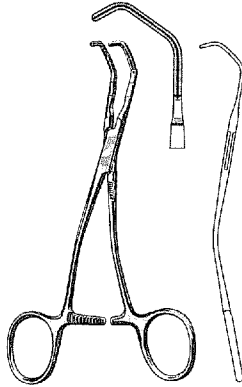

24-3260

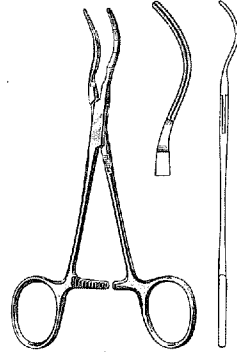

24-3270

COOLEY CLAMPS Pediatric Vascular Clamps,
5 mm calibrations on outer sides of jaws 4¾" (12.1 cm)

24-3230 right angle jaws 17 mm, straight handles

24-3240 right angle jaws 25 mm, straight handles

24-3250 right angle jaws 35 mm, straight handles

24-3260 COOLEY-SATINSKY Clamp 5½" (14 cm)

24-3270 COOLEY Spoon Shape Clamp 5½" (14 cm)

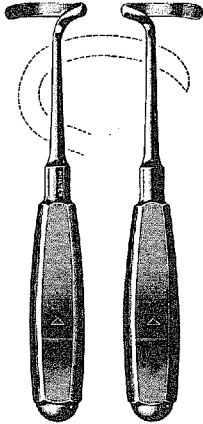

25-2 to 25-6



25-14



25-18

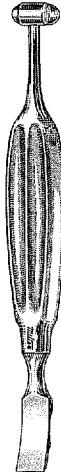

25-22



25-24

DOYEN RIB ELEVATORS AND RASPATORIES 7" (17.8 cm)

- 25-2 Adult Size, right
- 25-4 Adult Size, left
- 25-6 Child Size, right

25-14 MATSON-ALEXANDER Rib Elevator and Stripper 8¾" (22.2 cm)

25-18 MATSON Rib Elevator and Stripper 8¾" (22.2 cm)

25-22 ALEXANDER-FARABEU F Periosteotome 8¼" (21 cm), standard size, 12 mm and 24 mm wide ends

25-24 ALEXANDER-FARABEU F Periosteotome 6" (15.2 cm), pediatric size, 10 mm and 14 mm wide ends



Thoracic and Cardiovascular Instruments



25-28

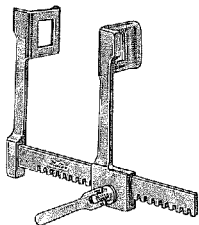

25-98

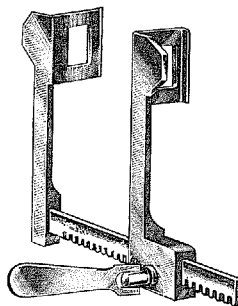

25-100 to 25-106

- 25-28** SEDILLOT Periosteal Elevator 7½" (19.1 cm), blade 17 mm wide
- 25-98** FINOCHIETTO-DeBAKEY Infant Rib Spreader, blades 19 mm deep x 21 mm wide, 85 mm spread, light construction

FINOCHIETTO RIB SPREADERS, Original Model

- 25-100** Child Size, blades 38 mm deep x 45 mm wide, 6" (15.2 cm) spread, straight arms
- 25-102** Standard Size, blades 48 mm deep x 65 mm wide, 8" (20.3 cm) spread, straight arms
- 25-104** Standard Size, blades 48 mm deep x 65 mm wide, 10" (25.4 cm) spread, straight arms
- 25-106** Standard Size, blades 48 mm deep x 65 mm wide, 12" (30.5 cm) spread, straight arms
- 25-130** Standard Size, blades 48 mm deep x 65 mm wide, 8" (20.3 cm) spread, curved arms
- 25-132** Standard Size, blades 48 mm deep x 65 mm wide, 10" (25.4 cm) spread, curved arms
- 25-134** Standard Size, blades 48 mm deep x 65 mm wide, 12" (30.5 cm) spread, curved arms

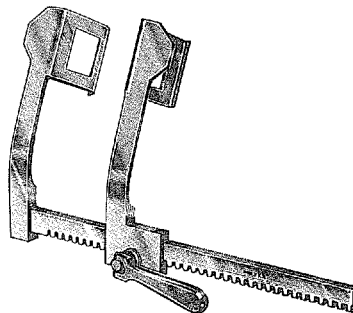

25-130 to 25-134

Thoracic and Cardiovascular Instruments

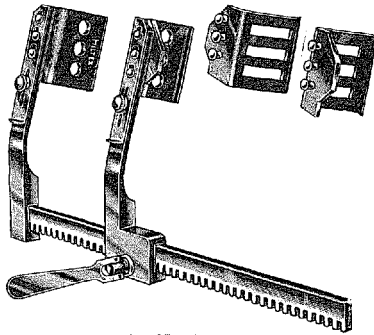

25-140 to 25-144

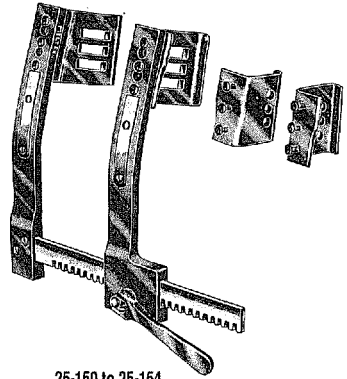

25-150 to 25-154

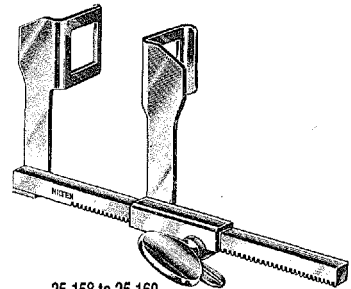

25-158 to 25-160

BURFORD-FINOCHIETTO RIB SPREADERS
with 2 pairs interchangeable blades 48 mm deep x 65 mm wide,
and 72 mm deep x 65 mm wide

- | | | | | | |
|---------------|---------------------|---------------|----------------------|---------------|----------------------|
| 25-140 | 8" (20.3 cm) Spread | 25-142 | 10" (25.4 cm) Spread | 25-144 | 12" (30.5 cm) Spread |
|---------------|---------------------|---------------|----------------------|---------------|----------------------|

BURFORD-FINOCHIETTO RIB SPREADERS, LIGHT WEIGHT ALUMINUM
with 2 pairs interchangeable blades 43 mm deep x 63 mm wide,
and 65 mm deep x 63 mm wide

- | | | | | | |
|---------------|---------------------|---------------|----------------------|---------------|----------------------|
| 25-150 | 8" (20.3 cm) Spread | 25-152 | 10" (25.4 cm) Spread | 25-154 | 12" (30.5 cm) Spread |
|---------------|---------------------|---------------|----------------------|---------------|----------------------|

25-158 HAIGHT Baby Rib Spreader, 6.5 cm arms, 32 x 32 mm blades, 11 cm spread

25-160 HAIGHT Baby Rib Spreader, 9 cm arms, 32 x 32 mm blades, 11 cm spread



Thoracic and Cardiovascular Instruments

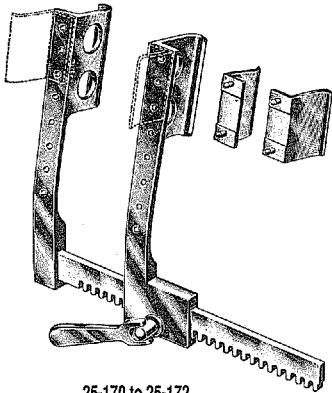

25-170 to 25-172

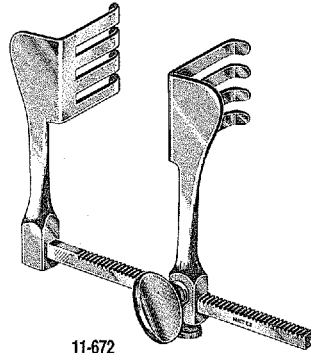

11-672

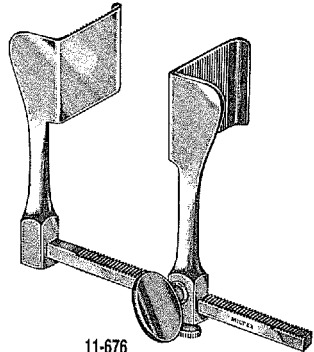

11-676

HARKEN RIB SPREADERS and SCAPULA RETRACTORS,
blades 45 mm deep x 65 mm wide,
with detachable scapula blades 43 mm deep x 50 mm wide

- | | | | |
|--------|---|--------|----------------------|
| 25-170 | 8" (20.3 cm) Spread | 25-172 | 10" (25.4 cm) Spread |
| 11-672 | BADGLEY Rib Spreader, 4 x 4 blunt teeth, 2" (5.1 cm) x 1 1/4" (4.4 cm), 6 1/2" (16.5 cm) spread | | |
| 11-676 | TUFFIER Rib Spreader, 2" (5.1 cm) x 1 3/4" (4.4 cm), grooved blades, 6 1/2" (16.5 cm) spread | | |

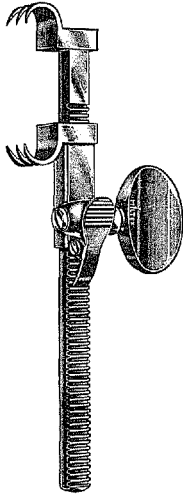

25-200

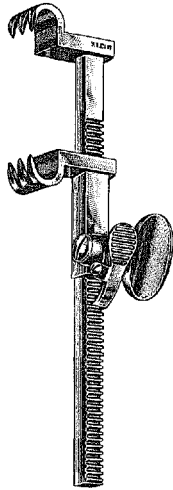

25-202

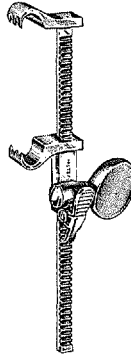

25-204

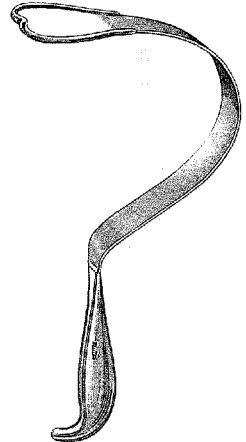

11-314 to 11-318

25-200 BAILEY Rib Contractor, Standard model

25-202 BAILEY-GIBBON Rib Contractor, with 9 mm longer arms than standard model

25-204 BAILEY Pediatric Rib Contractor, light-weight construction

11-314 HARRINGTON Splanchnik Retractor 12" (30.5 cm), large blade 2½" (6.4 cm) wide

11-316 HARRINGTON Splanchnik Retractor 12" (30.5 cm), small blade 1½" (3.8 cm) wide

11-318 HARRINGTON Splanchnik Retractor 9½" (24.1 cm), extra small blade 1" (2.5 cm) wide



Thoracic and Cardiovascular Instruments

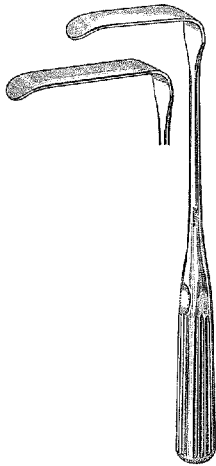

25-272
25-274

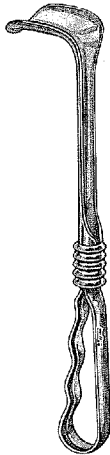

11-246 to 11-249

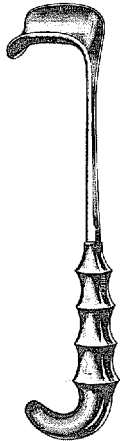

11-250 to 11-256

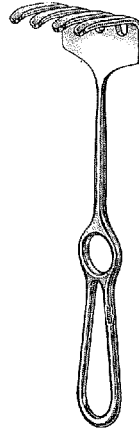

11-349

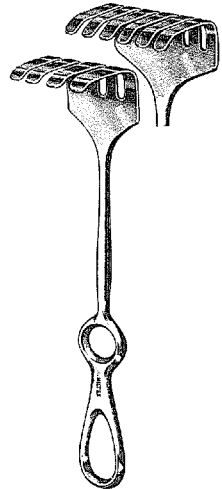

11-350
11-352

- 25-272 SAUERBRUCH Retractor 9" (22.9 cm), Size 2, blade $\frac{7}{8}$ " (2.2 cm) x $2\frac{1}{4}$ " (5.7 cm)
 25-274 SAUERBRUCH Retractor 9" (22.9 cm), Size 3, blade $\frac{3}{4}$ " (1.9 cm) x $2\frac{7}{8}$ " (7.3 cm)

RICHARDSON RETRACTORS 9½" (24.1 cm)

With Loop Handle	Blade Size	With Hollow Grip Handle
11-246	1" (2.5 cm) x $\frac{3}{4}$ " (1.9 cm)	11-250
11-247	$1\frac{1}{4}$ " (3.2 cm) x 1" (2.5 cm)	11-252
11-248	$1\frac{1}{2}$ " (3.8 cm) x $1\frac{1}{2}$ " (3.8 cm)	11-254
11-249	2" (5.1 cm) x $\frac{3}{4}$ " (1.9 cm)	11-256

- 11-349 OLLIER Retractor 8½" (21.6 cm), blunt, 4 prongs $2\frac{1}{4}$ " (5.7 cm) x $1\frac{3}{4}$ " (4.4 cm)
 11-350 ISRAEL Retractor 9" (22.9 cm), blunt, 4 prongs $1\frac{1}{2}$ " (3.8 cm) x $1\frac{1}{8}$ " (4.1 cm)
 11-352 ISRAEL Retractor 9" (22.9 cm), blunt, 6 prongs $2\frac{1}{4}$ " (5.7 cm) x $1\frac{3}{4}$ " (4.4 cm)
 11-590 HIBBS Retractor 9¼" (23.5 cm), blade 1" (2.5 cm) x 3" (9.6 cm) deep

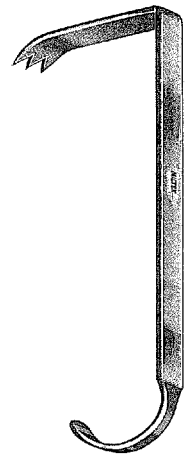

11-590

For additional Retractors see pages 151 - 187



25-302

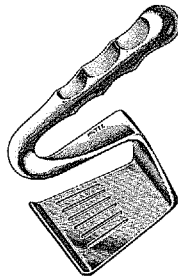

25-306

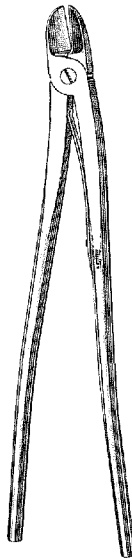

25-350



25-360

- 25-302 ALLISON Lung Retractor 12 $\frac{3}{4}$ " (32.4 cm), standard size 2" (5.1 cm) wide blade
- 25-306 DAVIDSON Scapula Retractor, blade 3 $\frac{1}{2}$ " (8.9 cm) wide x 3 $\frac{1}{4}$ " (8.3 cm) deep
- 25-350 BETHUNE Rib Shears 13 $\frac{3}{4}$ " (34.9 cm), double curved handles
- 25-360 GLUCK Rib Shears 8 $\frac{1}{2}$ " (21.6 cm)
- 25-362 STILLE Pattern Rib Shears 8 $\frac{1}{2}$ " (21.6 cm)

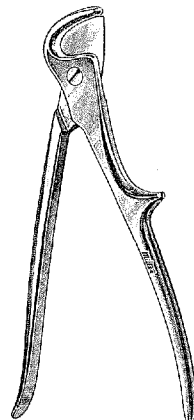

25-362

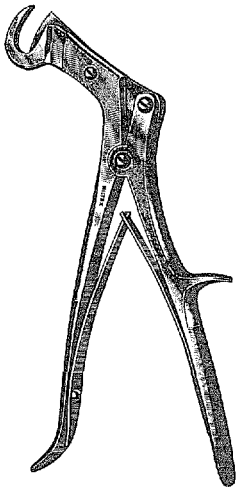

25-378

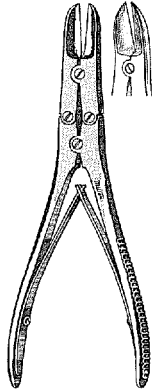

25-384 to 25-385

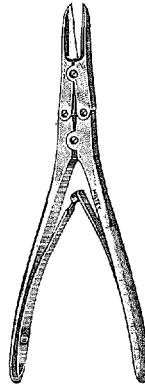

21-628

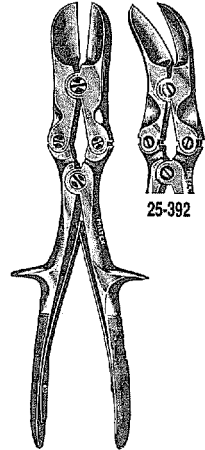

25-392

25-390

25-378 STILLE-GIERTZ Rib Shears 10" (25.4 cm)

25-384 RUSKIN Bone Cutting Forceps 7½" (19.1 cm), straight standard blades

25-385 RUSKIN Bone Cutting Forceps 7½" (19.1 cm), slightly angled standard blades

21-628 RUSKIN Bone Cutting Forceps 7½" (19.1 cm), straight delicate blades

25-390 STILLE-LISTON Bone Cutting Forceps 10¾" (27.3 cm), straight

25-392 STILLE-LISTON Bone Cutting Forceps 10¾" (27.3 cm), curved

25-396 STILLE-HORSLEY Bone Cutting Forceps 10½" (26.7 cm), angled blades

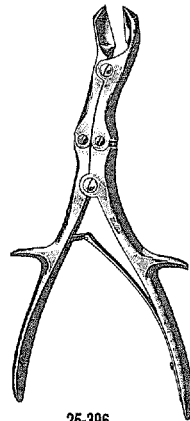

25-396

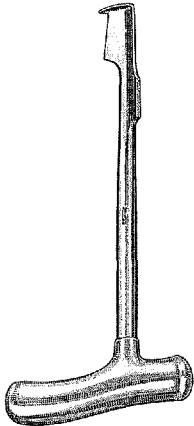

25-440

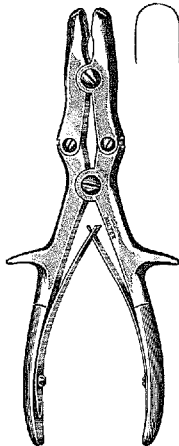

25-454

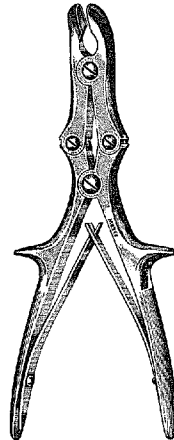

25-456

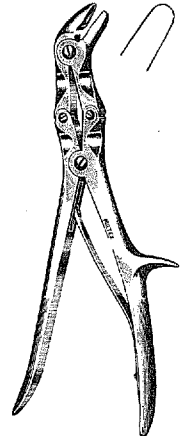

25-458

- 25-440 LEBSCHKE Sternum Knife 10" (25.4 cm)
- 25-454 STILLE-LUER Rongeur, 8¾" (22.2 cm), straight jaws 9 x 15 mm
- 25-456 STILLE-LUER Rongeur, 8¾" (22.2 cm), curved jaws 9 x 15 mm
- 25-458 STILLE-LUER Duckbill Rongeur, 9" (22.9 cm), angled on side jaws 6 x 12 mm

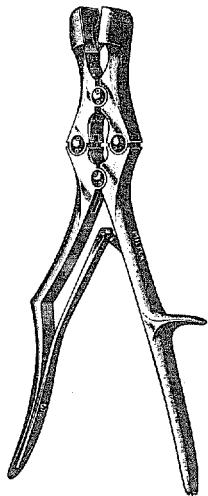

25-480

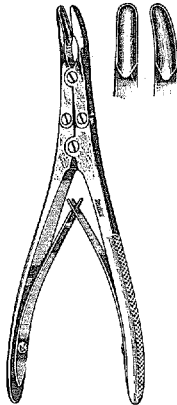

19-850 to 19-856

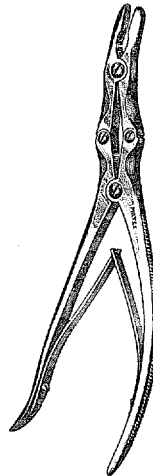

25-510
25-511

- 25-480 SAUERBRUCH Rongeur 12" (30.5 cm), straight, square jaws 17 mm wide
- 19-850 RUSKIN Rongeur 7¼" (18.4 cm), straight, 5 mm bite
- 19-852 RUSKIN Rongeur 7¼" (18.4 cm), curved, 5 mm bite
- 19-854 RUSKIN Rongeur 7¼" (18.4 cm), straight, 7 mm bite
- 19-856 RUSKIN Rongeur 7¼" (18.4 cm), curved, 7 mm bite
- 25-510 LEKSELL Rongeur 9½" (24.1 cm), standard curve, 3 mm bite
- 25-511 LEKSELL Rongeur 9½" (24.1 cm), standard curve, 8 mm bite

Thoracic and Cardiovascular Instruments

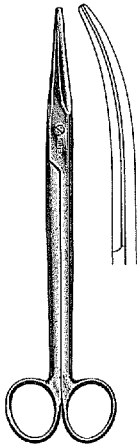

5-128
5-130

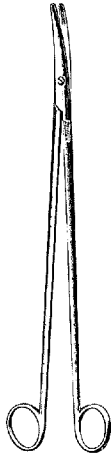

5-186 to 5-196

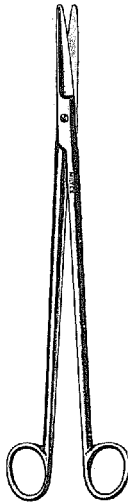

5-200



5-202

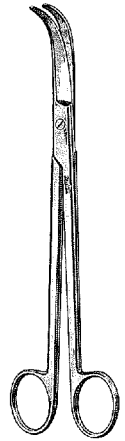

5-243

- 5-128 MAYO-HARRINGTON Dissecting Scissors 9" (22.9 cm), straight
- 5-130 MAYO-HARRINGTON Dissecting Scissors 9" (22.9 cm), curved

NELSON LOBECTOMY SCISSORS

	Length	Curved
5-186	9" (22.9 cm)	5-188
5-190	11" (27.9 cm)	5-192
5-194	14½" (36.8 cm)	5-196

- 5-200 HARRINGTON (WILLAUER) Lobectomy Scissors 11½" (29.2 cm), straight

- 5-202 HARRINGTON (WILLAUER) Lobectomy Scissors 11½" (29.2 cm), curved

- 5-243 JORGENSON Scissors 9" (22.9 cm), strongly curved blades

- 5-244 THOREK Scissors 7¼" (18.4 cm), full curve

- 5-245 THOREK Scissors 10" (25.4 cm), full curve

- 5-260 SWEET Esophageal Scissors 8½" (21.6 cm), angled on flat

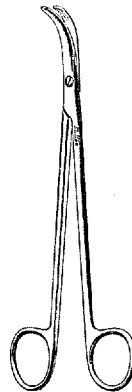

5-244
5-245

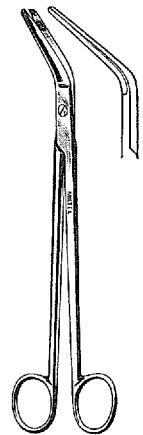

5-260

For Carb-N-Sert Scissors with tungsten carbide inserts see pages 55 - 59

For SuperCut Scissors see pages 60 - 63



6-140
6-141

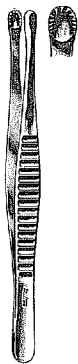

6-142 to 6-145



6-200 to 6-204

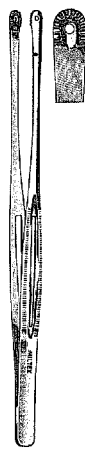

6-210

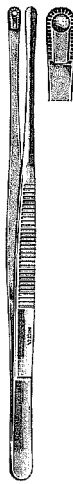

6-212

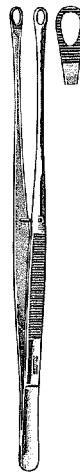

6-214



16-80

- 6-140 BROWN Side Grasping Tissue Forceps 8" (20.3 cm), 8 x 8 teeth
- 6-141 BROWN Side Grasping Tissue Forceps 10" (25.4 cm), 8 x 8 teeth
- 6-142 RUSSIAN Tissue Forceps 6" (15.2 cm)
- 6-144 RUSSIAN Tissue Forceps 8" (20.3 cm)
- 6-145 RUSSIAN Tissue Forceps 10" (25.4 cm)
- 6-200 KELLY Tissue Forceps 9" (22.9 cm), 1 x 2 teeth, slotted Gutch handle
- 6-202 KELLY Tissue Forceps 9" (22.9 cm), 2 x 3 teeth, slotted Gutch handle
- 6-204 KELLY Tissue Forceps 9" (22.9 cm), 3 x 4 teeth, slotted Gutch handle
- 6-210 MAYO-RUSSIAN Tissue Forceps 9" (22.9 cm), fenestrated jaws, slotted grooved handles
- 6-212 DAVIS Tissue Forceps 10" (25.4 cm), Russian type jaws
- 6-214 SINGLEY (TUTTLE) Tissue Forceps 9" (22.9 cm), fenestrated serrated jaws
- 16-80 WANGENSTEEN Tissue Forceps 9" (22.9 cm), rounded jaws with fine cross serrations

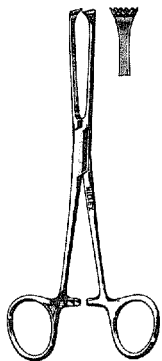

16-12

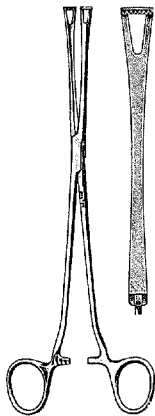

16-40

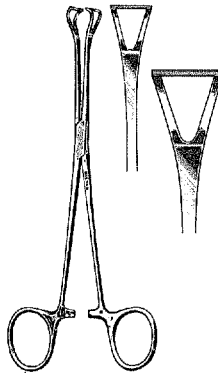

16-46
16-48

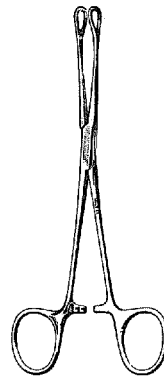

16-56

- 16-12 ALLIS Tissue Forceps 10" (25.4 cm), 5 x 6 teeth
- 16-40 LOCKWOOD Tissue Forceps 7¾" (19.7 cm)
- 16-46 BABCOCK Tissue Forceps 8¼" (21 cm)
- 16-48 BABCOCK Tissue Forceps 9½" (24.1 cm)
- 16-56 WILLIAMS Tissue Forceps 6½" (16.5 cm), fenestrated jaws with cross serrated tips

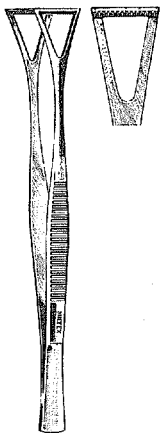

16-72

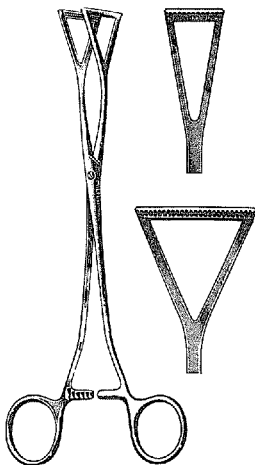

16-52
16-54
25-754

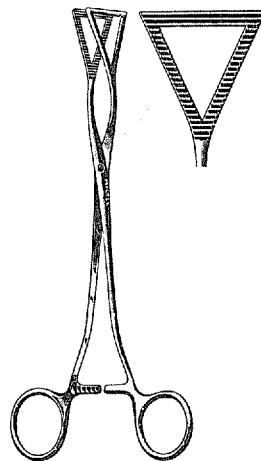

25-760

- 16-72 COLLIN-DUVAL Lung Grasping Forceps 8" (20.3 cm), with 1/2" (1.3 cm) wide jaws
- 16-52 COLLIN-DUVAL Lung Grasping Forceps 8" (20.3 cm), with 1/2" (1.3 cm) wide jaws
- 16-54 COLLIN-DUVAL Lung Grasping Forceps 8" (20.3 cm), with 1" (2.5 cm) wide jaws
- 25-754 COLLIN-DUVAL Lung Grasping Forceps 9" (22.9 cm), with 1" (2.5 cm) wide jaws
- 25-760 LOVELACE Lung Grasping Forceps 8" (20.3 cm), straight, serrated jaws 1" (2.5 cm) wide
- 14-66 LOVELACE Lung Grasping Forceps 7 1/4" (18.4 cm), angled shanks, serrated jaws 1" (2.5 cm) wide

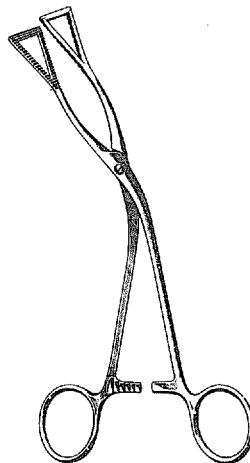

14-66

Thoracic and Cardiovascular Instruments

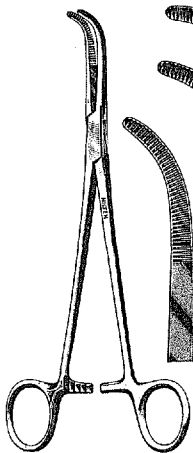

25-782 to 25-786

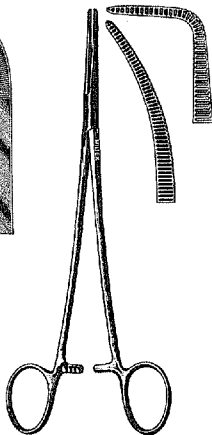

7-250 to 7-254

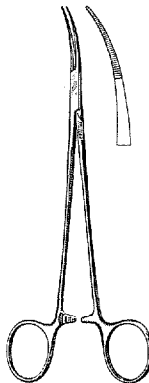

17-2603

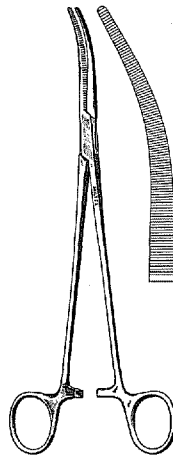

25-800

- 25-782 RUMEL Thoracic Forceps 9" (22.9 cm), medium curve, 2 $\frac{3}{8}$ " (6.1 cm) long jaws
- 25-784 RUMEL Thoracic Forceps 9" (22.9 cm), full curve, 2 $\frac{3}{8}$ " (6.1 cm) long jaws
- 25-786 RUMEL Thoracic Forceps 9" (22.9 cm), angular, 2 $\frac{3}{8}$ " (6.1 cm) long jaws

- 7-250 MOSQUITO Clamp 8 $\frac{1}{4}$ " (21 cm), straight
- 7-252 MOSQUITO Clamp 8 $\frac{1}{4}$ " (21 cm), curved
- 7-254 MOSQUITO Clamp 8 $\frac{1}{4}$ " (21 cm), angular

- 17-2603 JACOBSON Forceps 7" (17.8 cm), curved, extremely delicate

- 25-800 SAROT Intra-Thoracic Artery Forceps 9 $\frac{1}{2}$ " (24.1 cm), with 2 $\frac{1}{2}$ " (6.4 cm) long jaws

- 7-255 GEMINI-MIXTER Thoracic Forceps 5 $\frac{1}{2}$ " (14 cm), delicate full curved jaws
- 7-256 GEMINI-MIXTER Thoracic Forceps 7" (17.8 cm), delicate full curved jaws
- 7-257 GEMINI-MIXTER Thoracic Forceps 8" (20.3 cm), delicate full curved jaws
- 7-258 GEMINI-MIXTER Thoracic Forceps 9" (22.9 cm), delicate full curved jaws
- 7-259 GEMINI-MIXTER Thoracic Forceps 11" (27.9 cm), delicate full curved jaws

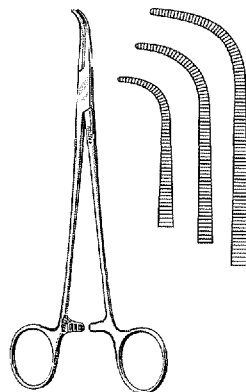

7-255 to 7-259



Thoracic and Cardiovascular Instruments

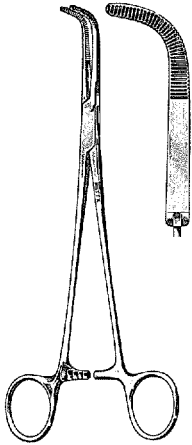

7-206

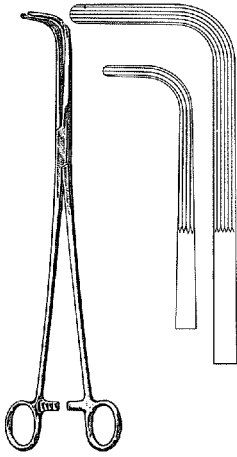

25-812
25-814

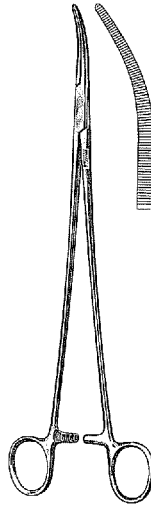

25-821

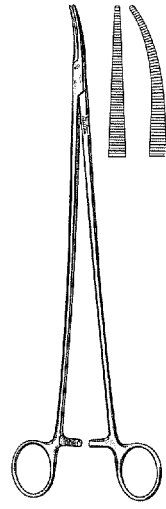

25-834
25-835

- 7-206 MIXTER Thoracic Forceps 9" (22.9 cm), full curved jaws, horizontal serrations
- 25-812 MIXTER Thoracic Forceps 9" (22.9 cm), right angle jaws, longitudinal serrations
- 25-814 MIXTER Thoracic Forceps 11" (27.9 cm), right angle jaws, longitudinal serrations
- 25-821 MILTEX Artery and Undermining Forceps 11" (27.9 cm), a delicate lightweight instrument with fine, serrated 45 mm long jaws
- 25-834 BRIDGE Deep Surgery Forceps 11" (27.9 cm), straight, very delicate
- 25-835 BRIDGE Deep Surgery Forceps 11" (27.9 cm), curved, very delicate
- 25-836 KANTROWITZ Thoracic Forceps 7½" (19.1 cm), delicate right angle jaws
- 25-837 KANTROWITZ Thoracic Forceps 9½" (24.1 cm), delicate right angle jaws
- 25-838 KANTROWITZ Thoracic Forceps 11" (27.9 cm), delicate right angle jaws

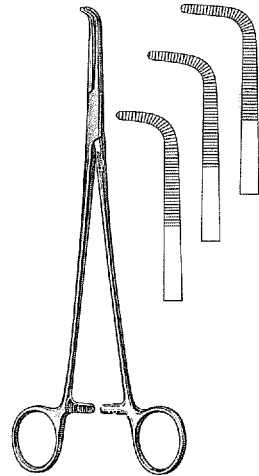

25-836 to 25-838

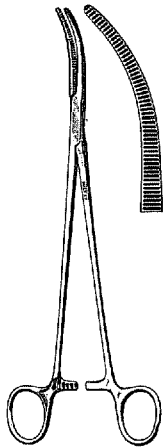

25-840

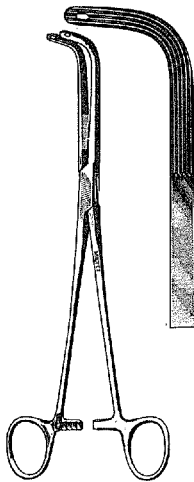

25-848

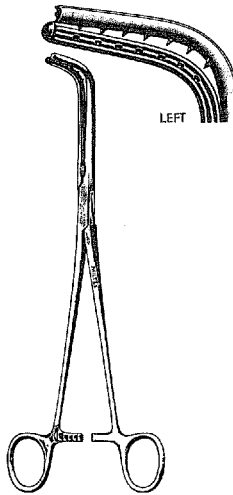

25-880
25-882

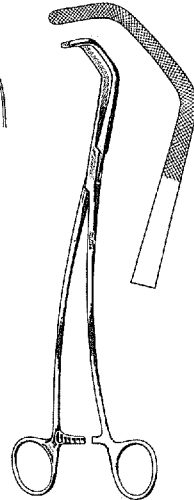

25-1100

- 25-840 FINOCHIETTO Thoracic Forceps 9" (22.9 cm), slightly curved jaws
- 25-848 FINOCHIETTO Thoracic Forceps and Ligature Carrier 9½" (24.1 cm), angular jaws with longitudinal serrations and suture holes at tip
- 25-880 SAROT Bronchus Clamp 9" (22.9 cm), Left, adult size, 35 mm long jaws
- 25-882 SAROT Bronchus Clamp 9" (22.9 cm), Right, adult size, 35 mm long jaws
- 25-1100 SATINSKY Vascular Clamp for Vena Cava 10¼" (27.3 cm), inside jaw length 32 mm x 9 mm depth
- 25-1104 SATINSKY Vascular Clamp for Vena Cava 10¼" (27.3 cm), inside jaw length 50 mm x 13 mm depth
- 25-1108 SATINSKY Vascular Clamp for Vena Cava 6½" (27.3 cm), pediatric size, inside jaw length 32 mm x 7 mm depth
- 25-1160 CRAFOORD Coarctation Clamp 9½" (24.1 cm), slightly curved jaws 65 mm with longitudinal serrations

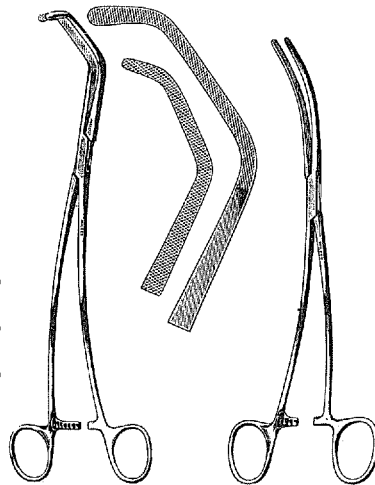

25-1104
25-1108

25-1160

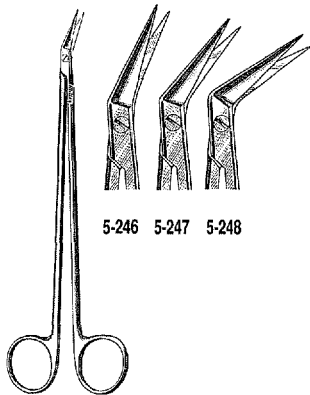

5-246 5-247 5-248

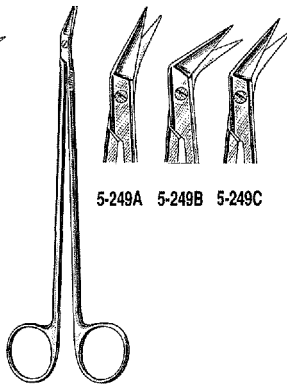

5-249A 5-249B 5-249C

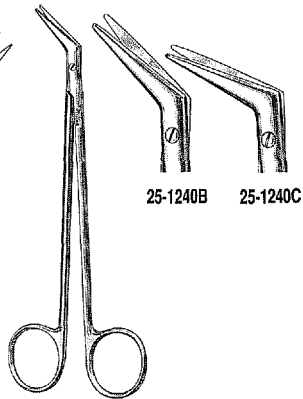

25-1240B 25-1240C

- 5-246 POTTS-SMITH Scissors 7½" (19.1 cm), angled on side 25°, 20 mm blades
- 5-247 POTTS-SMITH Scissors 7½" (19.1 cm), angled on side 45°, 20 mm blades
- 5-248 POTTS-SMITH Scissors 7½" (19.1 cm), angled on side 60°, 20 mm blades
- 5-249A POTTS-SMITH Scissors 7" (17.8 cm), delicate, angled on side 25°, 13 mm blades
- 5-249B POTTS-SMITH Scissors 7" (17.8 cm), delicate, angled on side 45°, 13 mm blades
- 5-249C POTTS-SMITH Scissors 7" (17.8 cm), delicate, angled on side 60°, 13 mm blades

- 25-1240B DeBAKEY-POTTS Scissors 6¾" (17.1 cm), blunt tips, angled on side 45°
- 25-1240C DeBAKEY-POTTS Scissors 6¾" (17.1 cm), blunt tips, angled on side 60°

- 5-176 REYNOLDS Dissecting Scissors 7" (17.8 cm), curved tenotomy type dissecting tips
- 5-178 REYNOLDS Dissecting Scissors 7" (17.8 cm), curved, tenotomy type dissecting tips, one serrated blade

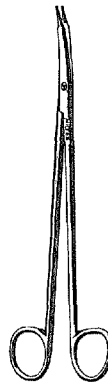

5-176
5-178

Thoracic and Cardiovascular Instruments



25-1280



6-154 to 6-159



6-160 to 6-164A



7-280 to 7-298

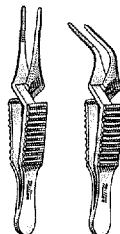

7-310
7-315

- 25-1280 SATINSKY Scissors 10" (25.4 cm), S-curved
- 6-154 POTTS-SMITH Dressing Forceps 7" (17.8 cm), serrated
- 6-156 POTTS-SMITH Dressing Forceps 8¼" (21 cm), serrated
- 6-158 POTTS-SMITH Dressing Forceps 9½" (24.1 cm), serrated
- 6-159 POTTS-SMITH Dressing Forceps 12" (30.5 cm), serrated
- 6-160 POTTS-SMITH Tissue Forceps 7" (17.8 cm), 1 x 2 teeth and serrated tips
- 6-162 POTTS-SMITH Tissue Forceps 8¼" (21 cm), 1 x 2 teeth and serrated tips
- 6-164 POTTS-SMITH Tissue Forceps 9½" (24.1 cm), 1 x 2 teeth and serrated tips
- 6-164A POTTS-SMITH Tissue Forceps 12" (30.5 cm), 1 x 2 teeth and serrated tips

JOHNS HOPKINS BULLDOG CLAMPS

Straight	Size	Curved
7-280	1½" (3.8 cm)	7-290
7-282	2" (5.1 cm)	7-292
7-284	2½" (6.4 cm)	7-294
7-286	3" (7.6 cm)	7-296
7-288	3½" (8.9 cm)	7-298

- 7-310 DIETHRICH Micro Bulldog Clamp 1⅞" (4.7 cm), straight jaws 8 mm x 1.2 mm
- 7-315 DIETHRICH Micro Bulldog Clamp 1⅞" (4.7 cm), angled jaws 8 mm x 1.2 mm
- 25-1420 Bulldog Clamp Applying Forceps 9½" (24.1 cm)

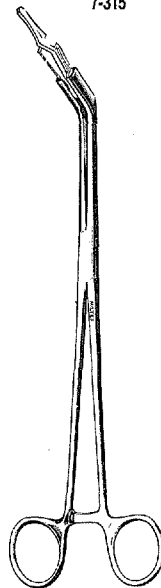

25-1420



Thoracic and Cardiovascular Instruments

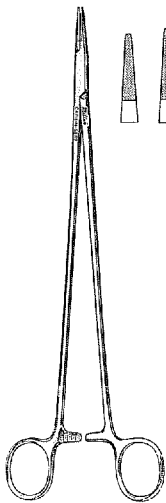

8-51TC to 8-57TC

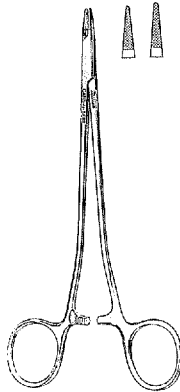

8-62TC
8-63TC

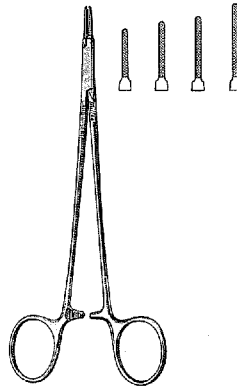

8-65TC to 8-69TC

- 8-51TC** CRILE-WOOD (DeBAKEY) Needle Holder 7" (17.8 cm), serrated Carb-N-Sert jaws 4000 teeth p. sq. inch
- 8-52TC** CRILE-WOOD (DeBAKEY) Needle Holder 8" (20.3 cm), serrated Carb-N-Sert jaws 2600 teeth p. sq. inch
- 8-53TC** CRILE-WOOD (DeBAKEY) Needle Holder 9" (22.9 cm), serrated Carb-N-Sert jaws 2600 teeth p. sq. inch
- 8-55TC** CRILE-WOOD (DeBAKEY) Needle Holder 10½" (26.7 cm), serrated Carb-N-Sert jaws 2600 teeth p. sq. inch
- 8-57TC** CRILE-WOOD (DeBAKEY) Needle Holder 12" (30.5 cm), serrated Carb-N-Sert jaws 2600 teeth p. sq. inch

- 8-62TC** COOLEY Needle Holder 6" (15.2 cm), extra delicate, serrated Carb-N-Sert jaws 4000 teeth p. sq. inch
- 8-63TC** COOLEY Needle Holder 6¼" (17.1 cm), extra delicate, serrated Carb-N-Sert jaws 4000 teeth p. sq. inch

- 8-65TC** RYDER-Type Intracardiac Needle Holder 5" (12.7 cm), extra delicate, serrated Carb-N-Sert jaws 4000 teeth p. sq. inch
- 8-66TC** RYDER-Type Intracardiac Needle Holder 6" (15.2 cm), extra delicate, serrated Carb-N-Sert jaws 4000 teeth p. sq. inch
- 8-67TC** RYDER-Type Intracardiac Needle Holder 7" (17.8 cm), extra delicate, serrated Carb-N-Sert jaws 4000 teeth p. sq. inch
- 8-69TC** RYDER-Type Intracardiac Needle Holder 9" (22.9 cm), extra delicate, serrated Carb-N-Sert jaws 4000 teeth p. sq. inch

Thoracic and Cardiovascular Instruments

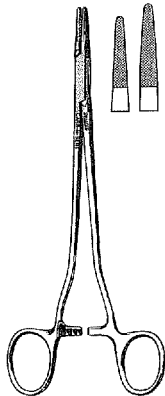

8-96TC
8-114TC

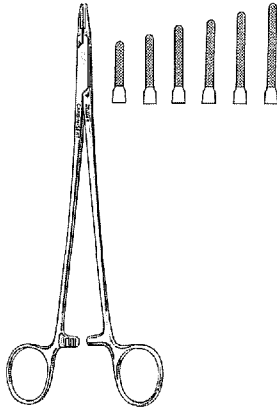

8-101TC to 8-107TC

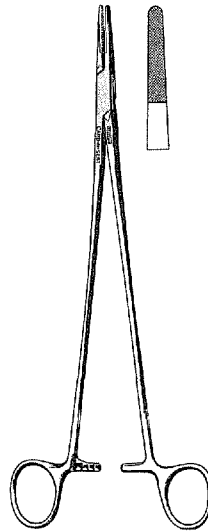

8-134TC

- 8-96TC SAROT Needle Holder 7¼" (18.4 cm), serrated Carb-N-Sert jaws 2600 teeth p. sq. inch
- 8-114TC SAROT Needle Holder 10½" (26.7 cm), serrated Carb-N-Sert jaws 2600 teeth p. sq. inch
- 8-101TC RYDER Needle Holder 5" (12.7 cm), serrated Carb-N-Sert jaws 4000 teeth p. sq. inch
- 8-103TC RYDER Needle Holder 6" (15.2 cm), serrated Carb-N-Sert jaws 4000 teeth p. sq. inch
- 8-104TC RYDER Needle Holder 7" (17.8 cm), serrated Carb-N-Sert jaws 4000 teeth p. sq. inch
- 8-105TC RYDER Needle Holder 8" (20.3 cm), serrated Carb-N-Sert jaws 4000 teeth p. sq. inch
- 8-106TC RYDER Needle Holder 9" (22.9 cm), serrated Carb-N-Sert jaws 4000 teeth p. sq. inch
- 8-107TC RYDER Needle Holder 10¼" (26 cm), serrated Carb-N-Sert jaws 4000 teeth p. sq. inch

8-134TC WANGENSTEEN Needle Holder 10¾" (27.3 cm), serrated Carb-N-Sert jaws 2600 teeth p. sq. inch

17-1090TC JACOBSON Microvascular Needle Holder 7" (17.8 cm), straight, with lock, serrated Carb-N-Sert jaws 16000 teeth p. sq. inch

17-1091TC JACOBSON Microvascular Needle Holder 7" (17.8 cm), curved, with lock, serrated Carb-N-Sert jaws 16000 teeth p. sq. inch

17-1092TC JACOBSON Microvascular Needle Holder 8½" (21.6 cm), straight, with lock, serrated Carb-N-Sert jaws 16000 teeth p. sq. inch

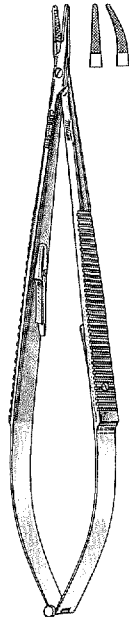

17-1090TC to 17-1092TC



Neurosurgical Instruments



26-2



26-16



26-18



26-20



26-24

26-2 CUSHING Perforator Drill $\frac{1}{2}$ " (1.3 cm) diameter

26-16 MCKENZIE Perforator Drill, 13 mm diameter

26-18 MCKENZIE Enlarging Bur, 16 mm diameter

26-20 D'ERRICO Perforator and Enlarging Bur, 16 mm diameter

Above Burs and Drills will fit Hudson Braces

26-24 HUDSON Cerebellar Extension 4" (10.2 cm), for use with Hudson Braces

Neurosurgical Instruments

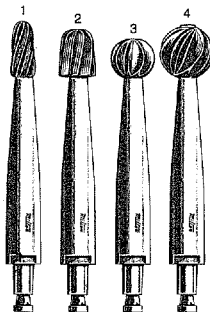

26-33-1 to 26-33-4

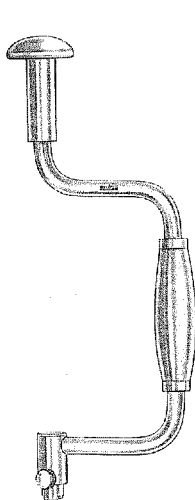

26-30
26-32

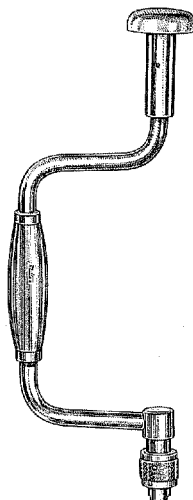

26-35

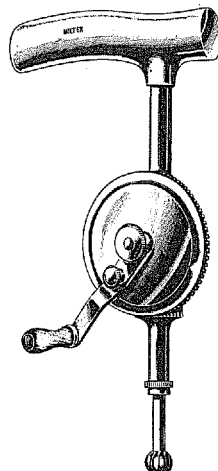

26-40
26-42

- 26-33-1 HUDSON Bur, 9 mm diameter
 26-33-2 HUDSON Bur, 14 mm diameter
 26-33-3 HUDSON Bur, 16 mm diameter
 26-33-4 HUDSON Bur, 22 mm diameter
- 26-30 HUDSON Brace Set, standard thumbscrew chuck, complete with 4 Burs (1 ea. Nos. 26-33-1 through 4)
 26-32 HUDSON Brace 10½" (26.7 cm), with standard thumbscrew chuck
 26-35 HUDSON Brace 11" (27.9 cm), with improved snap-lock chuck
- 26-40 STILLE Pattern Cranial Drill Set, complete with 4 twist drills (2.5 to 4 mm), 4 burs (4 to 16 mm) and 1 trephine (10 mm). Chrome plated drill, stainless points.
- 26-42 STILLE Pattern Cranial Drill 10" (25.4 cm), chrome plated



26-44



26-48

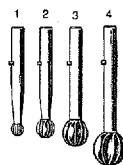

26-46

Replacement Points for Stille Pattern Drills

Twist Drills		Round Burs	
26-44-1	2.5 mm	26-46-1	4 mm
26-44-2	3 mm	26-46-2	8 mm
26-44-3	3.5 mm	26-46-3	11 mm
26-44-4	4 mm	26-46-4	16 mm
26-42	Trephine 10 mm dia.		

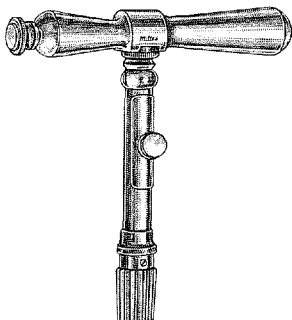

26-28A to 26-28E

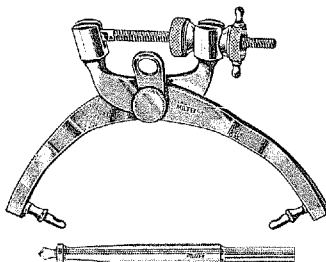

26-60
26-62

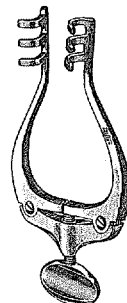

11-2

GALT SKULL TREPHINES, with Removable Handle For Use With Hudson Brace (26-30), Chrome Plated. Cutters and Adjustable Centering Points are Stainless

26-28A	1/2" (1.3 cm) dia.	26-28D	7/8" (2.2 cm) dia.
26-28B	5/8" (1.6 cm) dia.	26-28E	1" (2.5 cm) dia.
26-28C	3/4" (1.9 cm) dia.		

26-60 RANEY-CRUTCHFIELD Skull Traction Tong 120 mm spread, incl. 2 drill points

26-62 RANEY-CRUTCHFIELD Drill Point

11-2 JANSSEN Retractor 4 1/4" (10.8 cm), spread 3" (7.6 cm), 3 x 3 blunt prongs, 10 mm deep

11-4 JANSSEN Scalp Retractor 4 1/4" (10.8 cm), spread 3" (7.6 cm), 4 x 4 blunt prongs, 20 mm deep

11-8 JANSSEN-WAGNER Retractor 5" (12.7 cm), 5 x 5 sharp prongs, self adjusting

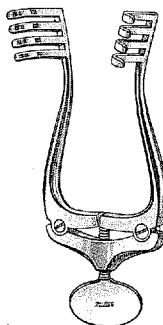

11-4

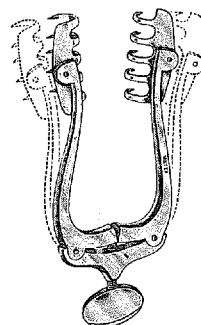

11-8

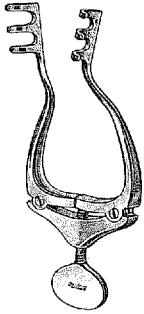

11-10

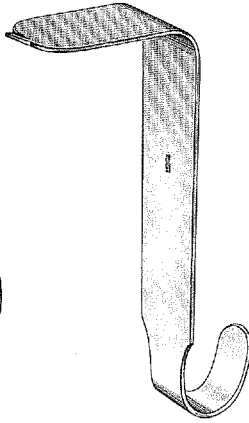

26-91
26-92

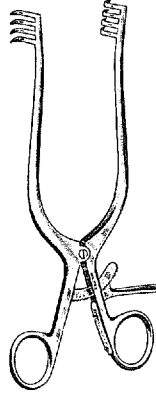

11-700

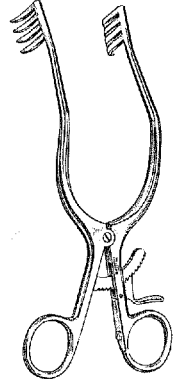

11-702

- 11-10 DAVIS Scalp Retractor 4½" (11.4 cm), 3 x 3 blunt prongs 10 mm deep
- 26-91 TAYLOR Spinal Retractor 7¼" (18.4 cm), blade 1¼" (3.2 cm) x 3" (7.6 cm)
- 26-92 TAYLOR Spinal Retractor 7¼" (18.4 cm), blade 1¼" (3.2 cm) x 4" (10.2 cm)
- 11-700 ADSON Cerebellar Retractor 7½" (19.1 cm), 4 x 4 teeth ¾" (1.9 cm) x ¾" (1.9 cm), straight arms
- 11-702 ADSON Cerebellar Retractor 7½" (19.1 cm), 4 x 4 teeth ¾" (1.9 cm) x ¾" (1.9 cm), angled arms

BECKMAN-WEITLANER RETRACTORS, with hinged blades, 3 x 4 teeth

Sharp	Size	Blunt
11-630-SH	5½" (14 cm)	11-630-BL (Cone Scalp Retr.)
11-634-SH (Cone Lamin. Retr.)	6½" (16.5 cm)	11-634-BL
11-642-SH (Cone Lamin. Retr.)	9" (22.9 cm)	11-642-BL

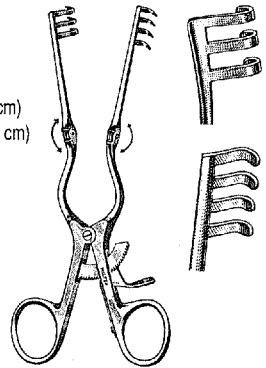

11-630 to 11-642



Neurosurgical Instruments

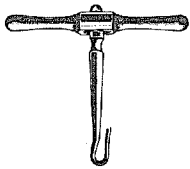

26-119

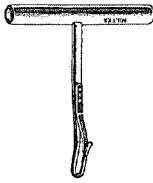

26-120

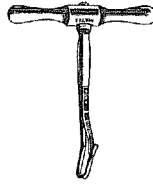

26-122

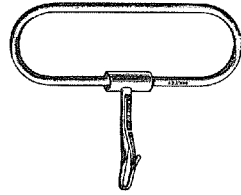

26-124

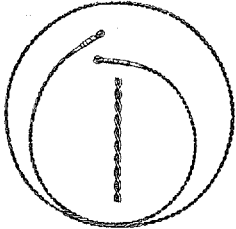

26-130 to 26-134



26-138

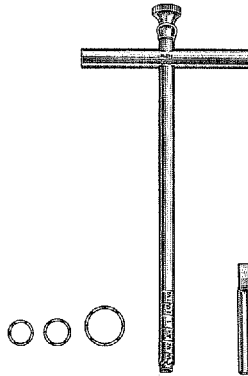

26-140 to 26-143

- 26-119 GIGLI Saw Handle, Standard Pattern, T-Shaped, turnable
- 26-120 GIGLI-STRULLY Saw Handle, Standard Pattern, T-Shape, rigid, with snap-lock
- 26-122 GIGLI-STRULLY Saw Handle, Standard Pattern, T-Shape, turnable, with snap-lock
- 26-124 GIGLI-STRULLY Saw Handle, Standard Pattern, Loop Grip, rigid, with snap-lock

- 26-130 GIGLI Saw 12" (30.5 cm), Standard twisted wire type
- 26-132 GIGLI Saw 20" (50.8 cm), Standard twisted wire type
- 26-134 GIGLI Saw 30" (76.2 cm), Standard twisted wire type

- 26-138 BAILEY GIGLI Saw Guide 12" (30.5 cm), flexible

- 26-140 MICHELE Trephine 6 1/4" (15.9 cm) shaft, 3/16" (.47 cm) O.D., graduated 1/4" (.64 cm) to 1 1/4" (3.2 cm)
- 26-141 MICHELE Trephine 6 1/4" (15.9 cm) shaft, 7/32" (.56 cm) O.D., graduated 1/4" (.64 cm) to 1 1/4" (3.2 cm)
- 26-142 MICHELE Trephine 6 1/4" (15.9 cm) shaft, 9/64" (.79 cm) O.D., graduated 1/4" (.64 cm) to 1 1/4" (3.2 cm)
- 26-143 Marker for No. 26-142 Michele Trephine

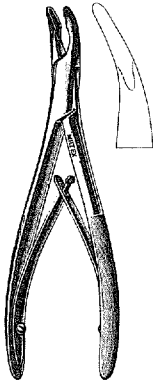

19-808

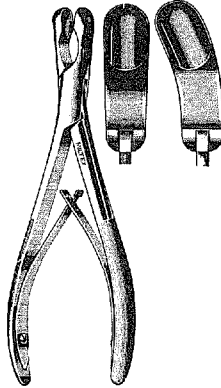

26-190
26-192

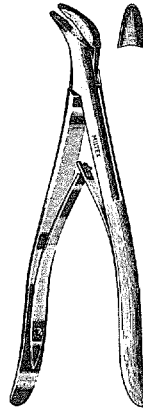

26-198

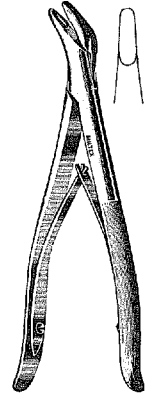

26-200

- 19-808 BANE Rongeur 7" (17.8 cm), curved
- 26-190 LUER Rongeur 7" (17.8 cm), straight jaws 8 mm bite
- 26-192 LUER Rongeur 7" (17.8 cm), curved jaws 8 mm bite
- 26-198 BACON Rongeur 8 1/4" (21 cm), angled on side, 5 mm bite
- 26-200 STOOKEY Rongeur 7 3/4" (19.7 cm), angled on side, 3 mm bite
- 26-220 ADSON Cranial Rongeur 8" (20.3 cm), straight jaws 7 x 13 mm
- 26-222 ADSON Cranial Rongeur 8" (20.3 cm), curved jaws 7 x 13 mm

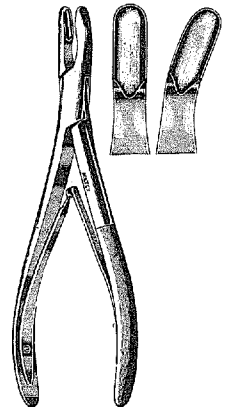

26-220
26-222

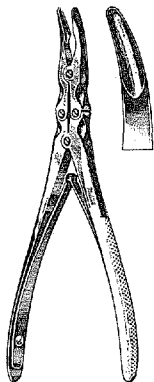

19-840

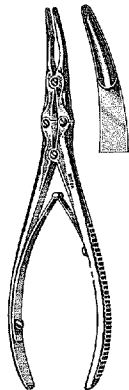

19-844

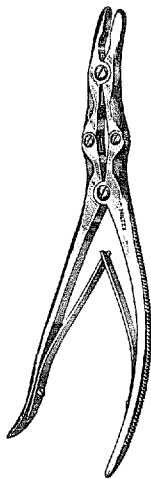

25-510
25-511

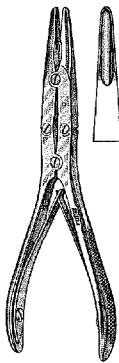

19-848

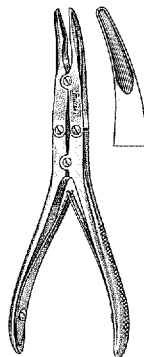

19-849

19-840 ZAUFEL-JANSEN Rongeur 7" (17.8 cm), slightly curved jaws 5 mm wide

19-844 BEYER Rongeur 7" (17.8 cm), slightly curved jaws 3.5 mm wide

25-510 LEKSELL Laminectomy Rongeur 9½" (24.1 cm), standard curve, 3 mm bite

25-511 LEKSELL Laminectomy Rongeur 9½" (24.1 cm), standard curve, 8 mm bite

RUSKIN RONGEURS

Straight Jaws

Size

Curved Jaws

19-848

6" (15.2 cm) long, 3 mm bite

19-849

19-850

7¼" (18.4 cm) long, 5 mm bite

19-852

19-854

7¼" (18.4 cm) long, 7 mm bite

19-856

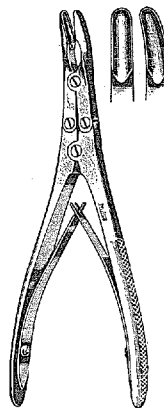

19-850 to 19-856

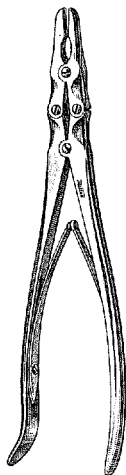

26-255 to 26-258

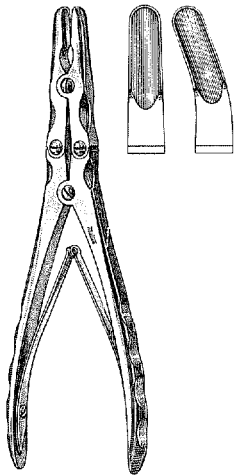

26-261
26-262

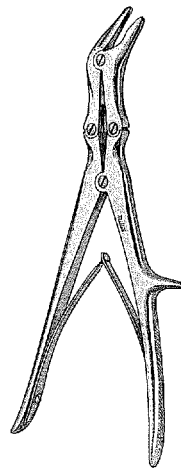

26-264 to 26-266

- 26-255 SMITH-PETERSEN Laminectomy Rongeur 7½" (19.1 cm), straight jaws, 3 mm bite
- 26-256 SMITH-PETERSEN Laminectomy Rongeur 7½" (19.1 cm), slightly curved jaws, 3 mm bite
- 26-258 SMITH-PETERSEN Laminectomy Rongeur 9½" (24.1 cm), straight jaws, 3 mm bite
- 26-261 FULTON Laminectomy Rongeur 9½" (24.1 cm), straight jaws 7 x 18 mm
- 26-262 FULTON Laminectomy Rongeur 9½" (24.1 cm), slightly curved jaws 7 x 18 mm
- 26-264 ECHLIN Duckbill Rongeur 9" (22.9 cm), 2 mm bite
- 26-265 ECHLIN Duckbill Rongeur 9" (22.9 cm), 3 mm bite
- 26-266 ECHLIN Duckbill Rongeur 9" (22.9 cm), 4 mm bite



Neurosurgical Instruments

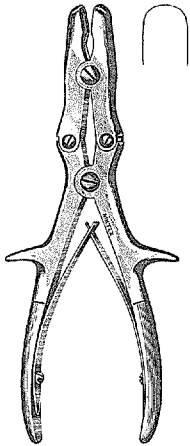

25-454

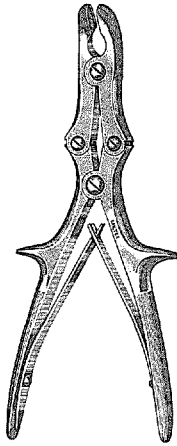

25-456

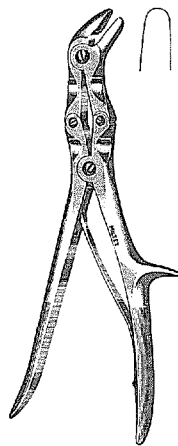

25-458

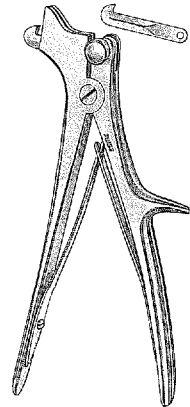

26-270

- 25-454 STILLE-LUER Rongeur 8 $\frac{3}{4}$ " (22.2 cm), straight jaws 9 x 15 mm
- 25-456 STILLE-LUER Rongeur 8 $\frac{3}{4}$ " (22.2 cm), curved jaws 9 x 15 mm
- 25-458 STILLE-LUER Duckbill Rongeur, 9" (22.9 cm), angled on side jaws 6 x 12 mm
- 26-270 DeVILBISS Cranial Rongeur 8 $\frac{1}{4}$ " (21 cm), with 2 blades

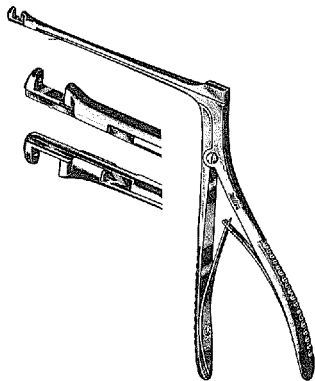

20-660
20-662

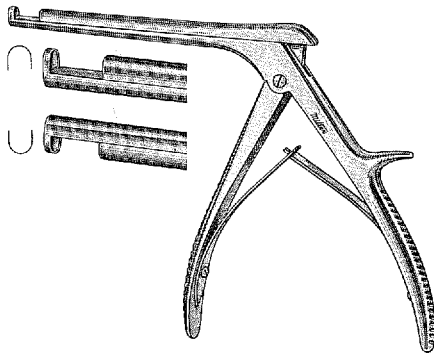

26-326 to 26-329

20-660
20-662

HAJEK-KOFLER Laminectomy Rongeur 5" (12.7 cm) shaft, up-bite, 4 x 5 mm
HAJEK-KOFLER Laminectomy Rongeur 5" (12.7 cm) shaft, down-bite, 4 x 5 mm

SCHLESINGER CERVICAL RONGEURS, THIN TIPS,
6" (15.2 cm) SHAFT

Up-Bite		Down-Bite	
26-326	3 mm	26-328	3 mm
26-327	5 mm	26-329	5 mm

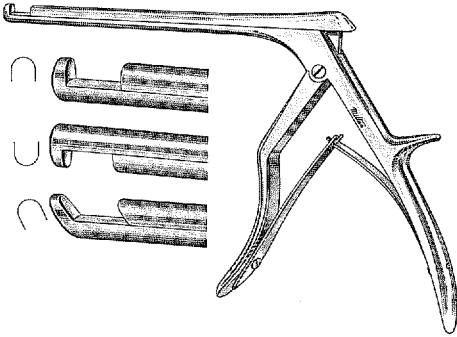

26-330 to 26-339B

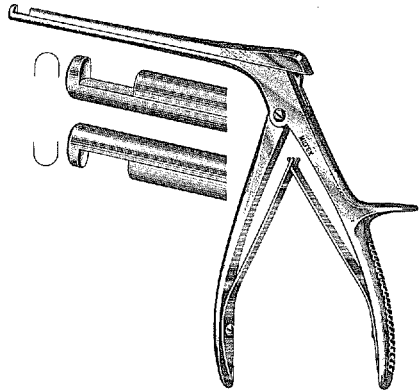

26-340 to 26-370

SPURLING-KERRISON CERVICAL RONGEURS

Up-Bite		Down-Bite		40° Forward Angle	
		6" (15.2 cm) Shaft			
26-330	3 mm	26-332	3 mm	26-334	3 mm
26-331	5 mm	—	—	26-335	5 mm
		8" (20.3 cm) Shaft			
26-336	3 mm	26-338	3 mm	26-339A	3 mm
26-337	5 mm	—	—	26-339B	5 mm

LOVE-KERRISON CERVICAL RONGEURS

Up-Bite		Down-Bite	
		6" (15.2 cm) Shaft	
26-340	3 mm	26-370	3 mm

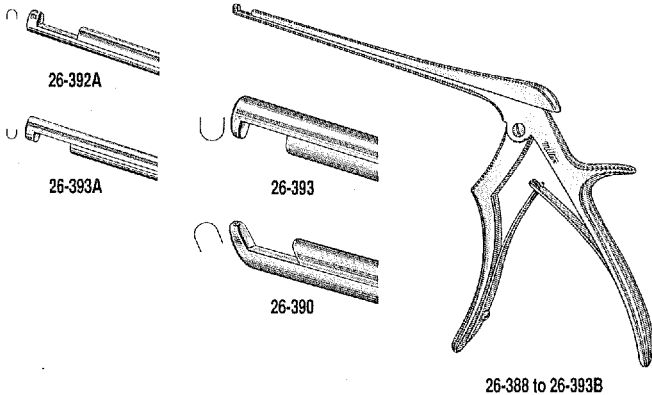

MILTEX-KERRISON CERVICAL RONGEURS
7" (17.8 cm) SHAFT, IMPROVED HANDLE

	2 mm	3 mm	5 mm
Up-Bite	26-392A	26-392B	26-392
Down-Bite	26-393A	26-393B	26-393
40° Forward Angle	26-388	26-389	26-390

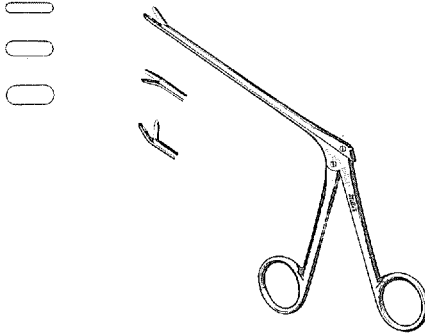

26-394 to 26-437

CUSHING PITUITARY RONGEURS 2 x 10 mm CUP JAWS

	Straight	Curved-Up	Curved-Down
5" (12.7 cm) Shank	26-394	26-395	26-396
7" (17.8 cm) Shank	26-397	26-398	26-399

LOVE-GRUENWALD PITUITARY RONGEURS 3 x 10 mm CUP JAWS

	Straight	Curved-Up	Curved-Down
5" (12.7 cm) Shank	26-400	26-410	26-420
7" (17.8 cm) Shank	26-402	26-412	26-422

SPURLING PITUITARY RONGEURS 4 x 10 mm CUP JAWS

	Straight	Curved-Up	Curved-Down
5" (12.7 cm) Shank	26-430	—	—
7" (17.8 cm) Shank	26-435	26-436	26-437

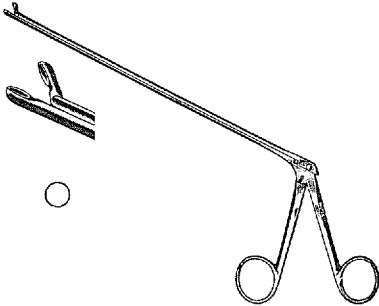

26-440

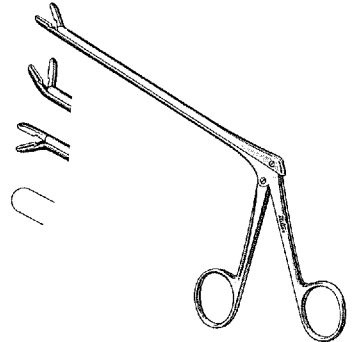

26-480 to 26-482

26-440 OLDBERG Pituitary Rongeur 7" (17.8 cm) Shank, round cup jaws 6 mm dia.

CLOWARD PITUITARY RONGEURS 6 x 10 mm CUP JAWS, 6" (15.2 cm) SHANKS

Straight	Curved-Up	Curved-Down
26-480	26-481	26-482

SCHLESINGER PITUITARY RONGEURS, SERRATED CUP JAWS, STRAIGHT 6" (15.2 cm) SHANKS

26-483	2 x 10 mm bite
26-484	3 x 10 mm bite
26-485	4 x 10 mm bite

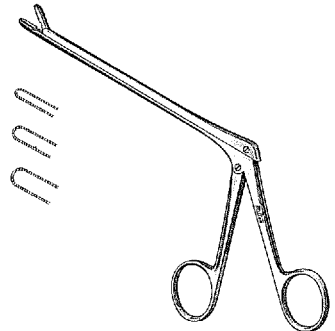

26-483 to 26-485

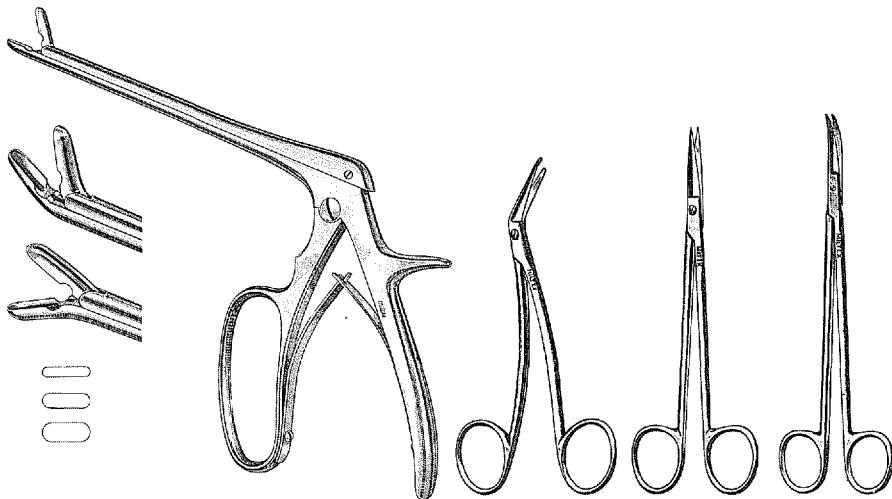

26-461 to 26-474

21-560

5-250
5D-251

5-252
5D-253

FERRIS-SMITH PITUITARY CUP JAW RONGEURS, 7" (17.8 cm) SHANK

	Straight	Curved-Up	Curved-Down
2 x 10 mm Jaws	—	—	26-470
3 x 10 mm Jaws	26-461	26-466	26-471
4 x 10 mm Jaws	26-462	—	26-472
6 x 12 mm Jaws	26-474 (Cloward Patt.)	—	—

- 21-560 TAYLOR Dural Scissors 5½" (14 cm), with probe tip
- 5-250 KELLY (ADSON) Ganglion Scissors 6¼" (15.9 cm), straight, sharp points
- 5D-251 KELLY (ADSON) Ganglion Scissors 6¼" (15.9 cm), straight, sharp points, with one serrated blade
- 5-252 KELLY (ADSON) Ganglion Scissors 6¼" (15.9 cm), curved, sharp points
- 5D-253 KELLY (ADSON) Ganglion Scissors 6¼" (15.9 cm), curved, sharp points, with one serrated blade
- 5-262 STRULLY Neurological Scissors 8" (20.3 cm), slightly curved blades with probe tips

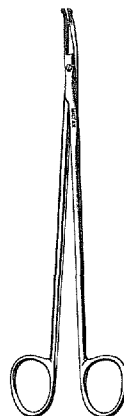

5-262

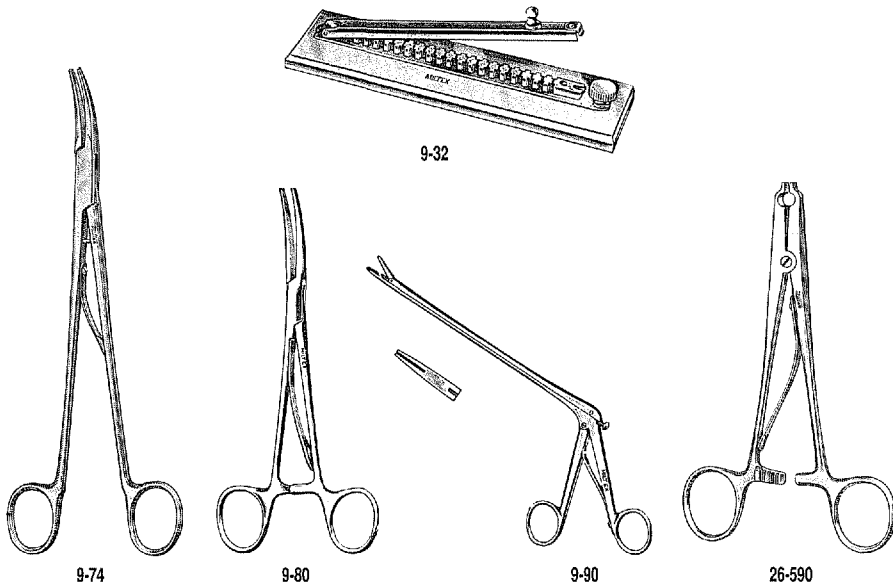

- 9-32 McKENZIE Brain Clip Holding Rack, for 20 clips
- 9-74 SMITHWICK Clip Applying Forceps 9" (22.9 cm), curved jaws, straight handles
- 9-80 McKENZIE Clip Applying Forceps 6" (15.2 cm), curved jaws, straight handles
- 9-90 SCOVILLE Clip Applying Forceps, 6" (15.2 cm) shaft
- 26-590 RANEY Scalp Clip Applying Forceps 6¼" (15.9 cm)
- 26-591 RANEY Reusable Scalp Clips, black finish



26-591

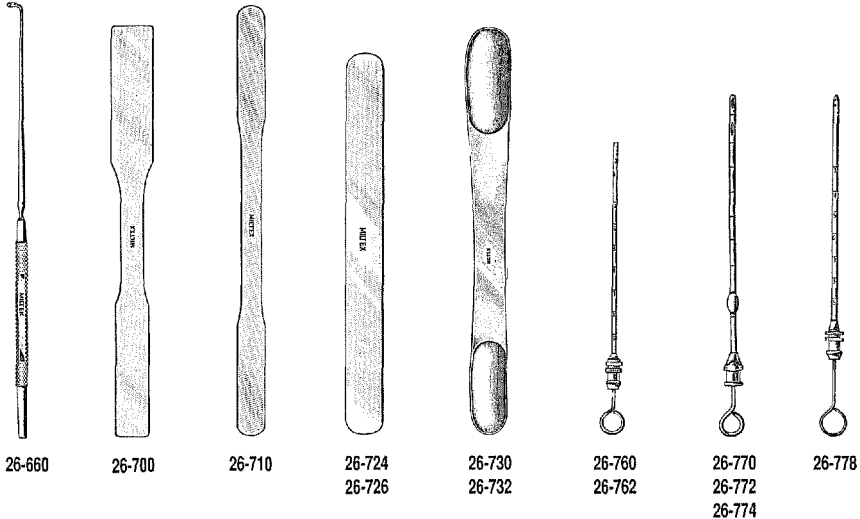

- 26-660 ADSON Aneurysm Needle 9" (22.9 cm)
- 26-700 SCOVILLE Spatula 8" (20.3 cm), malleable ends $\frac{5}{8}$ " (1.6 cm) and $\frac{3}{8}$ " (2.2 cm) wide
- 26-710 CHILDREN'S HOSPITAL Spatula 8 $\frac{1}{2}$ " (21.6 cm), malleable, ends are $\frac{1}{2}$ " (1.3 wide), silver plated
- 26-724 DAVIS Spatula 7" (17.8 cm) x $\frac{1}{2}$ " (1.3 cm), nickel silver, malleable
- 26-726 DAVIS Spatula 7" (17.8 cm) x $\frac{3}{4}$ " (1.9 cm), nickel silver, malleable
- 26-730 CUSHING Spatula Spoon 6 $\frac{3}{4}$ " (17.1 cm), spoon ends $\frac{1}{2}$ " (1.3 cm) and $\frac{3}{4}$ " (1.9 cm) wide
- 26-732 CUSHING Spatula Spoon 7 $\frac{3}{4}$ " (19.7 cm), spoon ends $\frac{3}{4}$ " (1.9 cm) and 1" (2.5 cm) wide
- 26-760 ADSON Cannula 9 Fr. (3 mm), 10 cm graduated in cm, open end, sterling
- 26-762 ADSON Cannula 9 Fr. (3 mm), 14 cm graduated in cm, open end, sterling
- 26-770 ELSBERG Cannula 11 cm, 3-hole closed end, 5 Fr., (1.7 mm), Luer lock, sterling
- 26-772 ELSBERG Cannula 11 cm, 3-hole closed end, 7 Fr., (2.3 mm), Luer lock, sterling
- 26-774 ELSBERG Cannula 11 cm, 3-hole closed end, 9 Fr., (3 mm), Luer lock, sterling
- 26-778 FRAZIER Needle 9 cm, 3-hole closed blunt trocar point, 9 Fr. (3 mm)



26-780
26-782



19-562 to 19-565

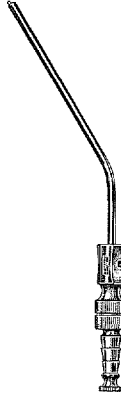

19-570 to 19-577



19-580
19-582
19-584

26-780
26-782

ADSON Suction Tube 6" (15.2 cm), with finger valve and obturator, 11 Fr. (3.6 mm)
ADSON Suction Tube 8" (20.3 cm), with finger valve and obturator, 15 Fr. (5 mm)

HOUSE SUCTION - IRRIGATING TUBES, 9 cm working length

19-562 1.8 mm Suction Tube and 1.8 mm Irrigating Tube
19-563 2.5 mm Suction Tube and 2 mm Irrigating Tube
19-564 3 mm Suction Tube and 2 mm Irrigating Tube
19-565 4.5 mm Suction Tube and 2 mm Irrigating Tube

FRAZIER SUCTION TUBES, with finger cut-off, angled

19-570	6 French (2 mm)	19-575	10 French (3.3 mm)
19-572	7 French (2.3 mm)	19-576	11 French (3.6 mm)
19-573	8 French (2.6 mm)	19-577	12 French (4 mm)
19-574	9 French (3 mm)		

19-580
19-582
19-584

BARON Suction Tube, 3 French (1 mm), with finger cut-off
BARON Suction Tube, 5 French (1.7 mm), with finger cut-off
BARON Suction Tube, 7 French (2.3 mm), with finger cut-off



Neurosurgical Instruments



6-118



6-118A

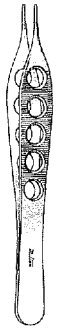

6-118XL



17-2510



6-120
6-122



6-120A

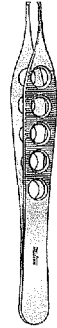

6-120XL



6-121

- 6-118** ADSON Dressing Forceps 4 3/4" (12.1 cm), serrated, delicate
6-118A ADSON Dressing Forceps 4 3/4" (12.1 cm), serrated, delicate, angled
6-118XL ADSON Dressing Forceps 4 3/4" (12.1 cm), serrated, lightweight, fenestrated handles
17-2510 Micro ADSON Dressing Forceps 4 3/4" (12.1 cm), serrated tips, 0.5 mm wide
6-120 ADSON Tissue Forceps 4 3/4" (12.1 cm), 1 x 2 teeth, delicate
6-120A ADSON Tissue Forceps 4 3/4" (12.1 cm), 1 x 2 teeth, delicate, angled
6-120XL ADSON Tissue Forceps 4 3/4" (12.1 cm), 1 x 2 teeth, lightweight, fenestrated handles
6-121 ADSON Tissue Forceps 4 3/4" (12.1 cm), 1 x 2 teeth and cross serrated tips, delicate
17-2500 Micro ADSON Tissue Forceps 4 3/4" (12.1 cm), tips 0.5 mm wide, 1 x 2 teeth
6-122 ADSON Tissue Forceps 4 3/4" (12.1 cm), 2 x 3 teeth, delicate
6-123 ADSON Tissue and Suture Forceps 4 3/4" (12.1 cm), 1 x 2 teeth with tying platform
6-123XL ADSON Tissue Forceps 4 3/4" (12.1 cm), w/platform, 1 x 2 teeth, lightweight, fenestrated handles



17-2500



6-123

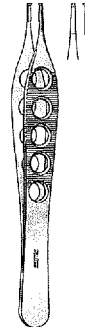

6-123XL



6-124

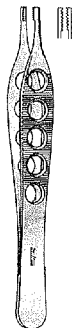

6-124XL



6-126



6-104
6-109



6-106
6-108
6-109A



6-107



6-166



6-168

- 6-124 BROWN-ADSON Tissue Forceps 4 1/4" (12.1 cm), 7 x 7 side grasping teeth
- 6-124XL BROWN-ADSON Tissue Forceps 4 1/4" (12.1 cm), 7 x 7 side grasping teeth, lightweight, fenestrated handles
- 6-126 BROWN-ADSON Tissue Forceps 4 1/4" (12.1 cm), 7 x 7 side grasping teeth, angular
- 6-104 SEMKEN Dressing Forceps 5" (12.7 cm), serrated
- 6-106 SEMKEN Tissue Forceps 5" (12.7 cm), 1 x 2 teeth
- 6-107 SEMKEN Tissue Forceps 5" (12.7 cm), 1 x 2 teeth, curved tips
- 6-108 SEMKEN Tissue Forceps 5" (12.7 cm), 2 x 3 teeth
- 6-109 SEMKEN Dressing Forceps 6" (15.2 cm), serrated
- 6-109A SEMKEN Tissue Forceps 6" (15.2 cm), 1 x 2 teeth
- 6-166 CUSHING Dressing Forceps 7" (17.8 cm), serrated, Gutch handle, dissecting end
- 6-168 CUSHING Tissue Forceps 7" (17.8 cm), 1 x 2 teeth, Gutch handle, dissecting end
- 6-188 CUSHING Dressing Forceps 7" (17.8 cm), serrated handle, serrated jaws, dissecting end
- 6-189 CUSHING Tissue Forceps 7" (17.8 cm), serrated handle, 1 x 2 teeth, dissecting end



6-188



6-189



Neurosurgical Instruments



6-138
6-140



6-180



6-182

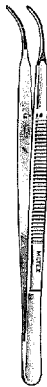

6-184

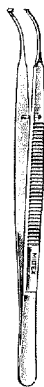

6-186



6-190



6-192



6-197
6-198

- 6-138 BROWN Tissue Forceps 6" (15.2 cm), double rows of 8 x 8 teeth
6-140 BROWN Tissue Forceps 8" (20.3 cm), double rows of 8 x 8 teeth
6-180 GERALD Dressing Forceps 7" (17.8 cm), straight, serrated
6-182 GERALD Tissue Forceps 7" (17.8 cm), straight, 1 x 2 teeth
6-184 GERALD Dressing Forceps 7" (17.8 cm), curved, serrated
6-186 GERALD Tissue Forceps 7" (17.8 cm), curved, 1 x 2 teeth
6-190 CUSHING Bayonet Dressing Forceps 7¼" (18.4 cm), serrated, scraper end
6-192 CUSHING Bayonet Tissue Forceps 7¼" (18.4 cm), 1 x 2 teeth, scraper end
6-197 GRUENWALD (JANSEN) Bayonet Dressing Forceps 6½" (16.5 cm), serrated
6-198 ADSON Bayonet Dressing Forceps 8¼" (21 cm), serrated
26-956 FERRIS SMITH Tissue Forceps 7" (17.8 cm), serrated platform tips with 1 x 2 teeth
26-958 FERRIS SMITH Tissue Forceps 7" (17.8 cm), serrated platform tips with 2 x 3 teeth

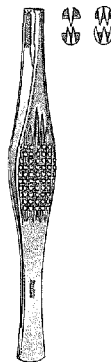

26-956
26-958

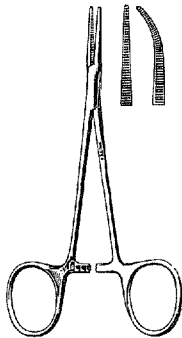

7-8
7-10

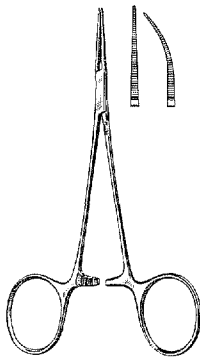

17-2600
17-2602

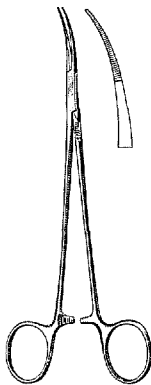

17-2603

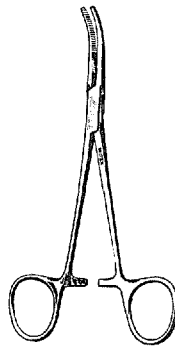

7-102

7-8 HALSTED Mosquito Forceps 5" (12.7 cm), straight, extra delicate

7-10 HALSTED Mosquito Forceps 5" (12.7 cm), curved, extra delicate

17-2600 JACOBSON Micro Mosquito Forceps 5" (12.7 cm), straight, extremely delicate

17-2602 JACOBSON Micro Mosquito Forceps 5" (12.7 cm), curved, extremely delicate

17-2603 JACOBSON Hemostatic Forceps 7" (17.8 cm), curved, extremely delicate

7-102 DANDY Scalp Hemostatic Forceps 5½" (14 cm), curved sideways, serrated

7-240 ADSON Hemostatic Forceps 7¼" (18.4 cm), straight

7-242 ADSON Hemostatic Forceps 7¼" (18.4 cm), curved

26-1040 SCHWARTZ Clip Applying Forceps 8" (20.3 cm)

26-1041 SCHWARTZ Vessel Clip 1" (2.5 cm), straight jaws 1.7 x 8 mm

26-1042 SCHWARTZ Vessel Clip 1" (2.5 cm), slightly angled jaws 1.7 x 8 mm

26-1043 SCHWARTZ Vessel Clip 1" (2.5 cm), strong angled jaws 1.7 x 8 mm

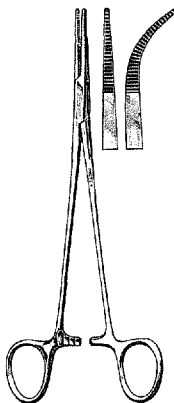

7-240
7-242

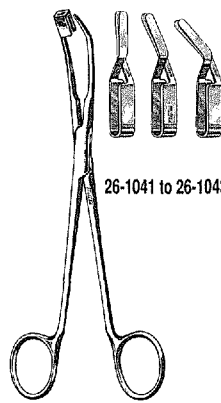

26-1041 to 26-1043

26-1040

For Micro Vessel Clips see page 223



26-1054



26-1080



26-1084
26-1086



26-1090
26-1092



21-430



26-1150

- 26-1054** FRAZIER Dura Separator 6½" (16.5 cm), angled blade ½" (1.3 cm) long, from ⅛" (.32 cm) to ¼" (.64 cm) wide
- 26-1080** CUSHING Dura Hook 6½" (16.5 cm), blunt
- 26-1084** FRAZIER Dura Hook 5" (12.7 cm), sharp point
- 26-1086** FRAZIER Dura Hook 5" (12.7 cm), blunt point
- 26-1090** ADSON Dura and Dissecting Hook 8" (20.3 cm), sharp blade 5 mm at right angle
- 26-1092** ADSON Dura Hook 8" (20.3 cm), blunt 5 mm hook at right angle
- 21-430** MILTEX Tissue Twist Hook 5½" (14 cm)
- 26-1150** DANDY Nerve Hook 9" (22.9 cm), straight



26-1156



26-1170

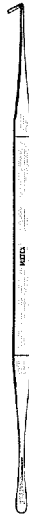

26-1174



11-100



11-102



26-1326

- 26-1156 GRAHAM Nerve Hook 7" (17.8 cm), blunt, 6 mm deep
- 26-1170 SMITHWICK Nerve Hook 7" (17.8 cm), blunt, 10 mm deep
- 26-1174 SMITHWICK Sympathectomy Hook and Dissector 12" (30.5 cm)
- 11-100 CUSHING Decompression Retractor 8½" (21.6 cm), fenestrated blade
- 11-102 CUSHING Vein and Nerve Retractor 9" (22.9 cm), blade 11 x 13 mm
- 26-1326 SACHS Nerve Separator-Spatula 7½" (19.1 cm), blunt blade 3 mm wide, slightly curved

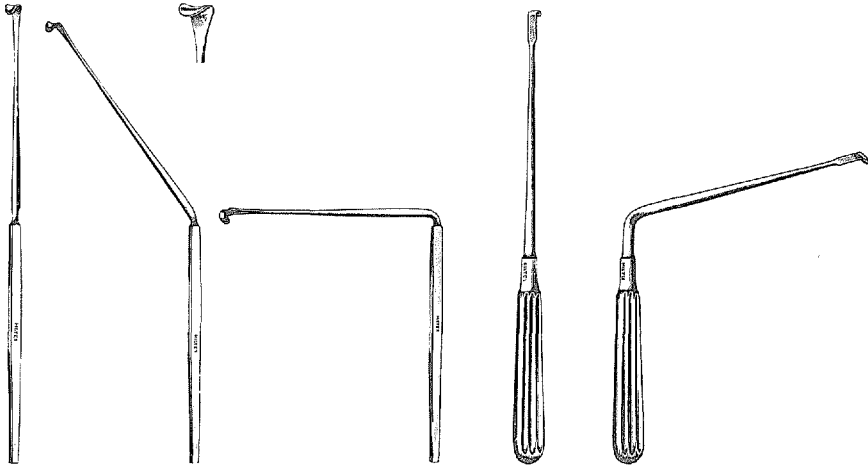

21-180

26-1352

26-1354

26-1360

26-1362

- 21-180** LOVE Nerve Root Retractor 8½" (21.6 cm), straight, 7 mm blade
- 26-1352** LOVE Nerve Root Retractor 8½" (21.6 cm), angled 45°, 7 mm blade
- 26-1354** LOVE Nerve Root Retractor 8½" (21.6 cm), angled 90°, 7 mm blade
- 26-1360** SCOVILLE Nerve Root Retractor 9" (22.9 cm), straight, 8 mm wide blade
- 26-1362** SCOVILLE Nerve Root Retractor 9" (22.9 cm), angular, 8 mm wide blade

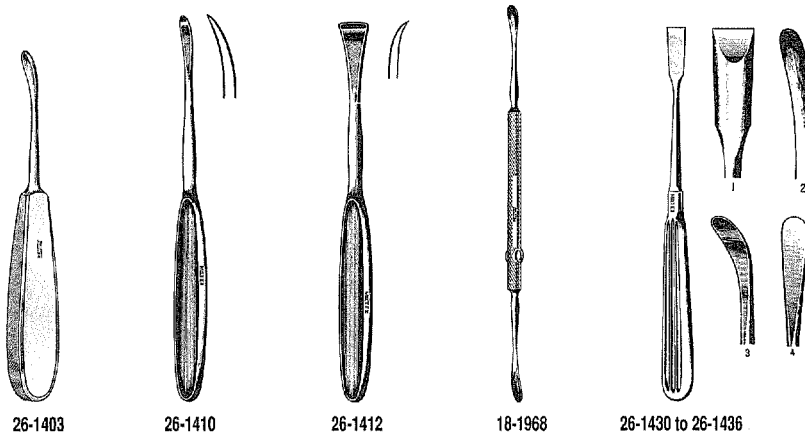

- 26-1403** CUSHING "LITTLE JOKER" Periosteal Elevator 6" (15.2 cm)
- 26-1410** LANGENBECK Periosteal Elevator 7½" (19.1 cm), narrow model, 7 mm wide blunt blade
- 26-1412** LANGENBECK Periosteal Elevator 7½" (19.1 cm), wide model, 17 mm wide sharp blade
- 18-1968** FREER Elevator 7" (17.8 cm), double end sharp and blunt blades 5 mm wide
- 26-1430** ADSON Periosteal Elevator 6½" (16.5 cm), chisel edge, straight, 8 mm wide
- 26-1432** ADSON Periosteal Elevator 6½" (16.5 cm), blunt, curved, 6 mm wide
- 26-1434** ADSON Periosteal Elevator 6½" (16.5 cm), semi-sharp, curved, 7 mm wide
- 26-1436** ADSON Periosteal Elevator 6½" (16.5 cm), semi-sharp, straight, 6 mm wide

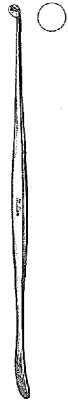

26-1450



26-1451



26-1452



26-1453



26-1454

PENFIELD DISSECTORS

- | | | |
|----------------|-------------|--|
| 26-1450 | Style No. 1 | 7¼" (18.4 cm), double end, 6 mm sharp cup and 6 mm blunt dissector |
| 26-1451 | Style No. 2 | 7¾" (19.7 cm), double end, wax packer and 6 mm blunt dissector, slightly curved |
| 26-1452 | Style No. 3 | 7½" (19.1 cm), double end, wax packer and 6 mm blunt dissector, fully curved |
| 26-1453 | Style No. 4 | 8¾" (22.2 cm), single end, light pattern, 3 mm blunt dissector, slightly curved |
| 26-1454 | Style No. 5 | 11½" (29.2 cm), double end, slightly curved, blunt dissector blades 7 mm and 8 mm wide |

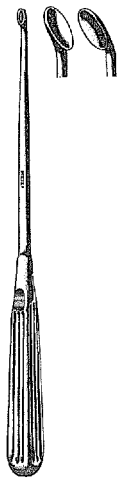

26-1620
26-1624

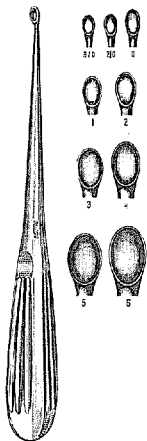

26-1627 to 26-1640

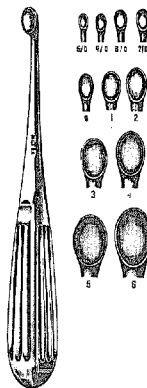

19-700 to 19-720

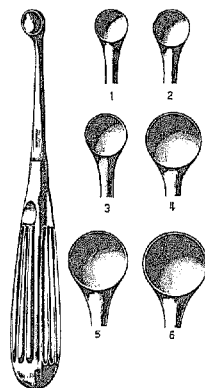

26-1650 to 26-1660

26-1620
26-1624

SCOVILLE Ruptured Disc Curette 10" (25.4 cm), angled up, cup 4 x 10 mm
SCOVILLE Ruptured Disc Curette 10" (25.4 cm), angled down, cup 4 x 10 mm

HIBBS SPRATT SPINAL FUSION CURETTES 9" (22.9 cm), Oval Cup

26-1627	Size 3/0	26-1634	Size 3
26-1628	Size 2/0	26-1636	Size 4
26-1629	Size 0	26-1638	Size 5
26-1630	Size 1	26-1640	Size 6
26-1632	Size 2		

SPRATT (BRUN) BONE CURETTES 6½" (16.5 cm), Oval Cups

19-700	Size 5/0	19-712	Size 2
19-702	Size 4/0	19-714	Size 3
19-704	Size 3/0	19-716	Size 4
19-706	Size 2/0	19-718	Size 5
19-708	Size 0	19-720	Size 6
19-710	Size 1		

BRUN BONE CURETTES 6¾" (17.1 cm), Round Cups

26-1650	Size 1	7 mm	26-1656	Size 4	11 mm
26-1652	Size 2	8 mm	26-1658	Size 5	12 mm
26-1654	Size 3	9 mm	26-1660	Size 6	14 mm



Neurosurgical Instruments

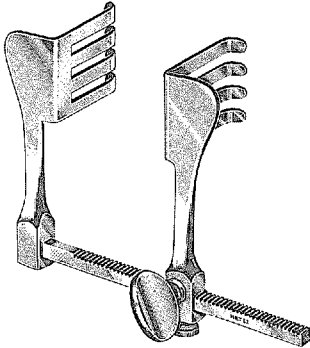

11-672

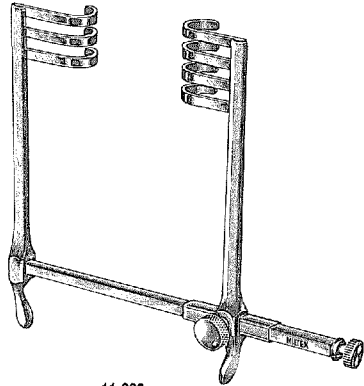

11-660

- 11-672 BADGLEY Laminectomy Retractor, 6½" (16.5 cm) spread, 4 x 4 blunt teeth 2" (5.1 cm) x 1¼" (4.4 cm)
- 11-660 FRAZIER Laminectomy Retractor, 3¼" (8.3 cm) spread, 3 x 4 blunt teeth
- 11-676 TUFFIER Retractor, 6½" (16.5 cm) spread, 2" (5.1 cm) x 1¼" (4.4 cm) grooved blades

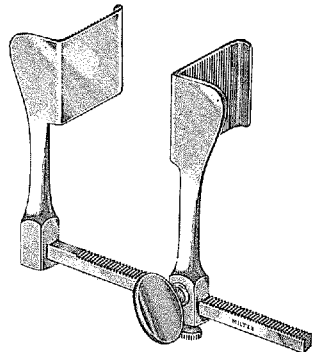

11-676

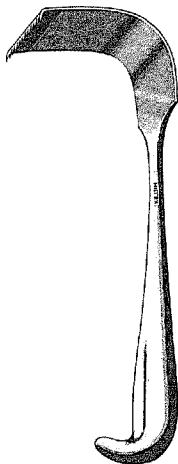

11-240 to 11-244

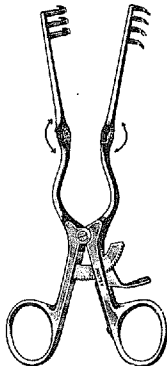

11-642-SH
11-642-BL

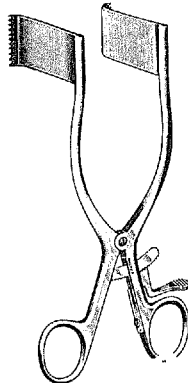

11-650 to 11-656

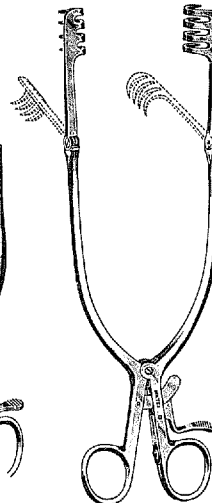

11-684
11-686

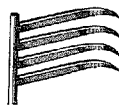

- 11-240 MEYERDING Laminectomy Retractor 9½" (24.1 cm), large blade 3½" (8.9 cm) x 2" (5.1 cm)
- 11-242 MEYERDING Laminectomy Retractor 9½" (24.1 cm), medium blade 3" (7.6 cm) x 1" (2.5 cm)
- 11-244 MEYERDING Laminectomy Retractor 9½" (24.1 cm), small blade 2" (5.1 cm) x ¾" (1.6 cm)

- 11-642-SH BECKMAN-WEITLANER Retractor, hinged, 9" (22.9 cm), sharp 3 x 4 teeth
- 11-642-BL BECKMAN-WEITLANER Retractor, hinged, 9" (22.9 cm), blunt 3 x 4 teeth

MEYERDING SELF-RETAINING LAMINECTOMY RETRACTORS, ¾" (9.5 cm) spread

- 11-650 1" (2.5 cm) x 2¾" (6.1 cm) blades
- 11-652 1" (2.5 cm) x 2½" (5.4 cm) blades
- 11-654 1" (2.5 cm) x 1¾" (4.4 cm) blades
- 11-656 ¾" (1.9 cm) x 2¾" (6.1 cm) blades
- 11-684 BECKMAN-ADSON Laminectomy Retractor 12½" (31.8 cm), hinged, sharp 4 x 4 teeth 1" (2.5 cm) wide x ¾" (1.9 cm) deep
- 11-686 BECKMAN-ADSON Laminectomy Retractor 12½" (31.8 cm), hinged, sharp 4 x 4 teeth 1¼" (3.2 cm) wide x 1¾" (4.4 cm) deep

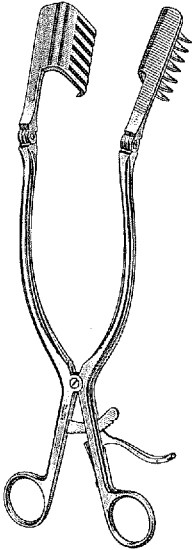

26-1973

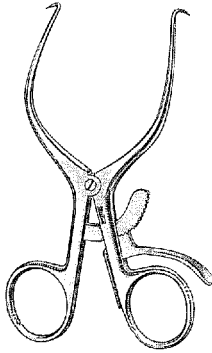

11-365
11-366

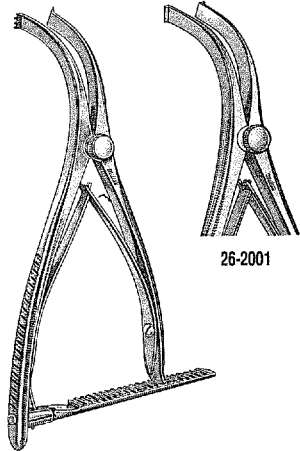

26-2001

26-2000
26-2005

- 26-1973** BECKMAN-EATON Laminectomy Retractor 12¾" (32.4 cm), hinged, sharp
7 x 7 teeth 1¾" (4.4 cm) wide x 2" (5.1 cm) deep
- 11-365** Pediatric GELPI Retractor 5½" (14 cm), with grip lock
- 11-366** GELPI Retractor 6¾" (17.1 cm), with grip lock
- 26-2000** INGE Lamina Spreader 6" (15.2 cm), jaws open to 1½" (2.8 cm)
- 26-2001** INGE Lamina Spreader 6" (15.2 cm), jaws open to 1½" (2.8 cm), without teeth
- 26-2005** INGE Lamina Spreader 9½" (24.1 cm), jaws open to 1¾" (4.4 cm)

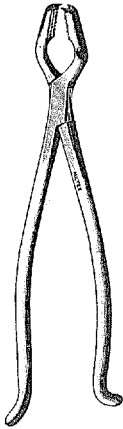

27-2
27-6

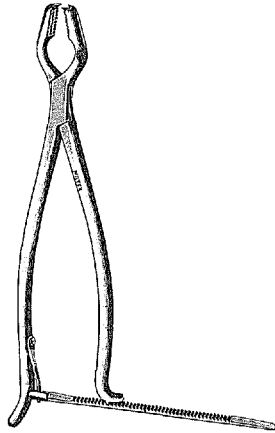

27-4
27-7

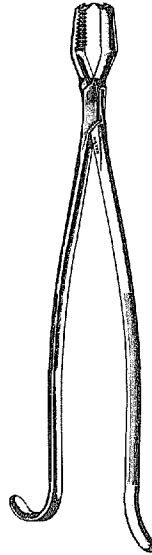

27-20
27-22

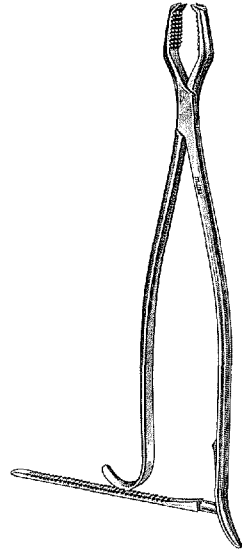

27-21
27-23

- 27-2 KERN Bone Holding Forceps 9½" (24.1 cm), standard size, plain
- 27-4 KERN Bone Holding Forceps 9½" (24.1 cm), standard size, with ratchet
- 27-6 KERN Bone Holding Forceps 6" (15.2 cm), pediatric size, plain
- 27-7 KERN Bone Holding Forceps 6" (15.2 cm), pediatric size, with ratchet

- 27-20 LANE Bone Holding Forceps 13" (33 cm), plain
- 27-21 LANE Bone Holding Forceps 13" (33 cm), with ratchet
- 27-22 LANE Bone Holding Forceps 17" (43.2 cm), plain
- 27-23 LANE Bone Holding Forceps 17" (43.2 cm), with ratchet

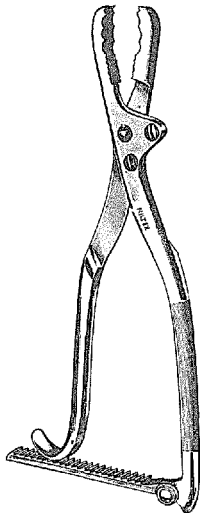

27-14

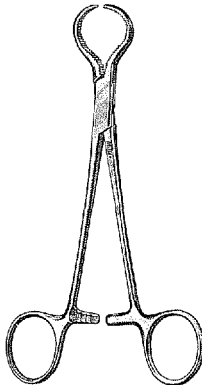

27-16

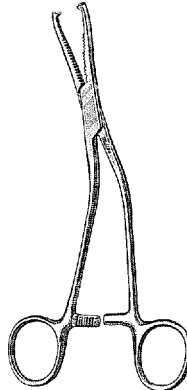

27-24

- 27-14 FARABEUF-LAMBOTTE Bone Holding Forceps, 10 $\frac{1}{4}$ " (26 cm)
- 27-16 LEWIN Bone Holding Forceps 7" (17.8 cm), serrated jaws
- 27-24 DINGMAN Small Bone and Cartilage Clamp 7 $\frac{1}{2}$ " (19.1 cm), serrated jaws, 2 x 2 teeth, 4 mm wide

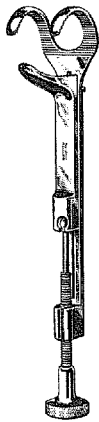

27-30 to 27-34

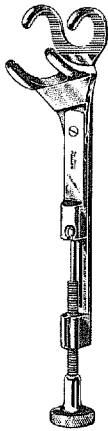

27-42
27-44

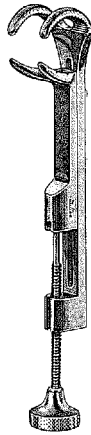

27-46
27-47

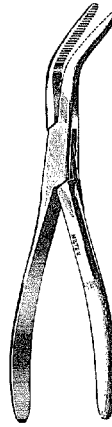

27-60

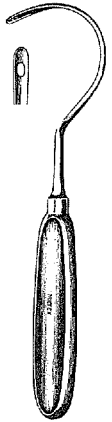

27-110

- 27-30 LOWMAN Bone Clamp 5" (12.7 cm), calibrated in $\frac{1}{8}$ " (.32 cm), 1 x 2 prong jaws $\frac{3}{4}$ " (1.9 cm) wide
- 27-32 LOWMAN Bone Clamp 7" (17.8 cm), calibrated in $\frac{1}{8}$ " (.32 cm), 1 x 2 prong jaws 1" (2.5 cm) wide
- 27-34 LOWMAN Bone Clamp 8" (20.3 cm), calibrated in $\frac{1}{8}$ " (.32 cm), 1 x 2 prong jaws $1\frac{1}{4}$ " (3.2 cm) wide
- 27-42 LOWMAN-HOGLUND Bone Clamp 7" (17.8 cm), calibrated in $\frac{1}{8}$ " (.32 cm), 2 x 2 prong swivel jaws 1" (2.5 cm) wide
- 27-44 LOWMAN-HOGLUND Bone Clamp 8" (20.3 cm), calibrated in $\frac{1}{8}$ " (.32 cm), 2 x 2 prong swivel jaws $1\frac{1}{8}$ " (3.5 cm) wide
- 27-46 LAMBERT-LOWMAN Bone Clamp 7" (17.8 cm), 2 x 2 prong jaws 1" (2.5 cm) wide
- 27-47 LAMBERT-LOWMAN Bone Clamp 8" (20.3 cm), 2 x 2 prong jaws $1\frac{1}{8}$ " (3.5 cm) wide
- 27-60 VAN BUREN Sequestrum Forceps 9" (22.9 cm), serrated jaws angled on side
- 27-110 Bone Wire Guide $8\frac{3}{4}$ " (22.2 cm), U.S. Pattern
- 27-144 POLK Finger Goniometer 6" (15.2 cm), graduated in inches and centimeters

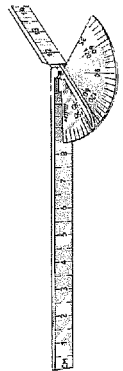

27-144

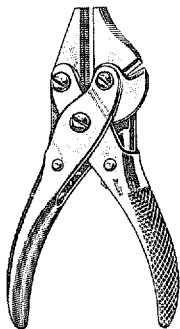

9-128

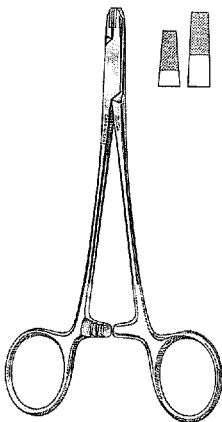

22-500TC
22-502TC

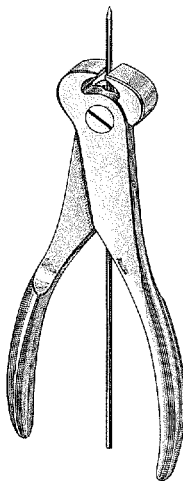

27-158

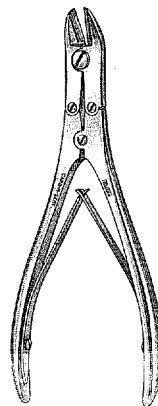

27-159TC

- 9-128 Double Action Parallel Pliers and Wire Cutter 4½" (11.4 cm), nickel plated
- 22-500TC Wire Twister 6" (15.2 cm), with Carb-N-Sert jaws
- 22-502TC Wire Twister 8" (20.3 cm), with Carb-N-Sert jaws
- 27-158 MILTEX Cannulated Pin and Wire Cutter 7½" (19.1 cm), end cutting up to 3.2 mm (¼") soft wire or 1.6 mm (⅛") hard wire
- 27-159TC C-N-S Pin and Wire Cutter 7" (17.8 cm), double action, CARB-N-SERT cutting blades, cuts up to 2 mm (¾") soft wire or 1.6 mm (⅛") hard wire
- 27-160 DIAMOND Pin and Wire Cutter 6½" (16.5 cm), cuts up to 2 mm (¾") diameter hard wire, stainless

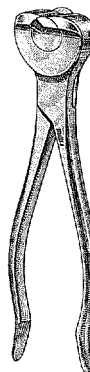

27-160

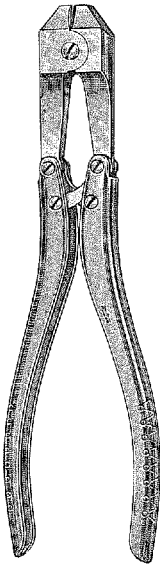

27-161TC

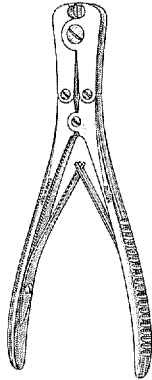

27-163TC

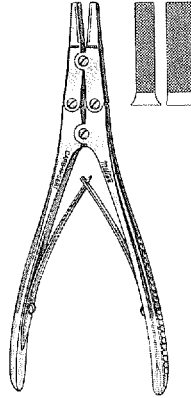

27-164TC
27-165TC

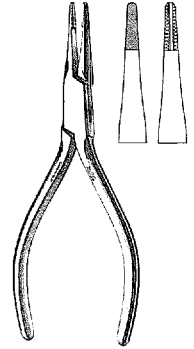

27-176TC

- 27-161TC** MILTEX Double Action Pin Cutter 15" (38.1 cm), heavy duty, with CARB-N-SERT cutting blades, will cut up to 4.8 mm ($\frac{3}{16}$ " diameter, stainless
- 27-163TC** C-N-S Front and Side Pin and Wire Cutter 7" (17.8 cm), Double Action Flush Cutting CARB-N-SERT Blades cuts up to 2 mm ($\frac{5}{64}$ " soft wire or 1.6 mm ($\frac{1}{16}$ " hard wire
- 27-164TC** C-N-S Pin & Wire Puller 7" (17.8 cm), double action, with CARB-N-SERT 4 mm wide jaws
- 27-165TC** C-N-S Pin & Wire Puller 7" (17.8 cm), double action, with CARB-N-SERT 6 mm wide jaws
- 27-176TC** MILTEX Pin Puller 5½" (14 cm) CARB-N-SERT serrated top jaw measures 1 cm in length. Grooved cross-serrated opposing jaw. (Groove measures 1 cm in length.)

For Orthopedic Suture Wire & Wire Cutting Scissors – see pages 135 & 141.

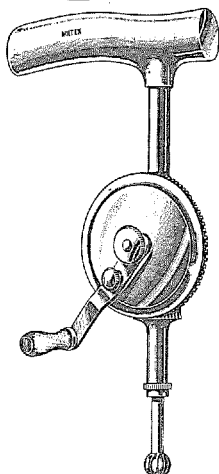

26-40
26-42

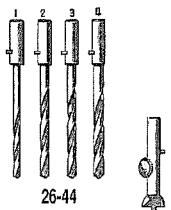

26-44

26-48

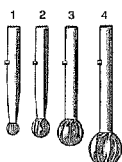

26-46

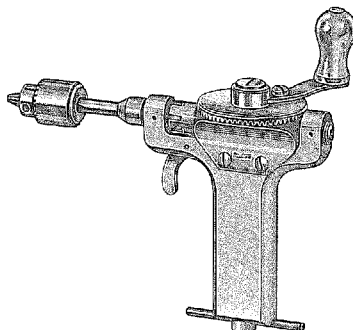

27-180

26-40 STILLE Pattern Drill Set, complete with 4 twist drills (2.5 to 4 mm), 4 burs (4 to 16 mm) and 1 trephine (10 mm). Chrome plated drill, stainless points

26-42 STILLE Pattern Drill, chrome plated

Replacement Points for Stillle Pattern Drill

Twist Drills		Round Burs	
26-44-1	2.5 mm	26-46-1	4 mm
26-44-2	3 mm	26-46-2	8 mm
26-44-3	3.5 mm	26-46-3	11 mm
26-44-4	4 mm	26-46-4	16 mm
26-48	Trephine 10 mm dia.		

27-180 BUNNELL Hand Drill, Lightweight, chrome plated, with $\frac{1}{2}$ " (4 mm) capacity stainless Jacobs chuck. Cannulated for use with Kirschner wires and thin drills. Chuck key stores in handle.

KIRSCHNER WIRES 12" (30.5 cm), Trocar Point with Flat Chuck End

27-202	.035" (0.9 mm) diameter
27-204	.045" (1.1 mm) diameter
27-206	.0625" (1.6 mm) diameter

KIRSCHNER WIRES 7 $\frac{1}{2}$ " (19.1 cm), Trocar Points at both ends

27-208	.035" (0.9 mm) diameter
27-210	.045" (1.1 mm) diameter
27-212	.0625" (1.6 mm) diameter

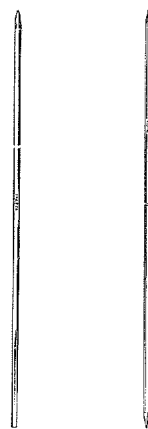

27-202 to 27-206

27-208 to 27-212



27-213
27-214



27-215 to 27-218

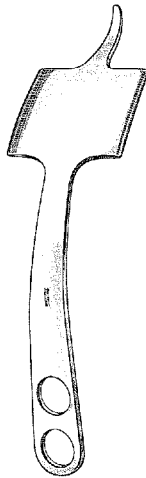

27-219



11-580
11-582



27-223

- 27-213 MINI-HOHMANN Retractor 6¼" (15.9 cm), blade 6 mm wide
27-214 MINI-HOHMANN Retractor 6¼" (15.9 cm), blade 8 mm wide

- 27-215 HOHMANN Retractor 9¼" (23.5 cm), blade 10 mm wide
27-216 HOHMANN Retractor 9¼" (23.5 cm), blade 18 mm wide
27-217 HOHMANN Retractor 9¼" (23.5 cm), blade 25 mm wide
27-218 HOHMANN Retractor 9¼" (23.5 cm), blade 43 mm wide
27-219 HOHMANN Retractor 9¾" (24.8 cm), blade 70 mm wide

- 11-580 BENNETT Bone Elevator and Retractor 9½" (24.1 cm), small blade 1¾" (4.4 cm) wide

- 11-582 BENNETT Bone Elevator and Retractor 9¾" (24.8 cm), large blade 2½" (6.4 cm) wide

- 27-223 BLOUNT Knee Retractor 7" (17.8 cm), blade 1¾" (4.4 cm) deep, ⅝" (1.6 cm) wide tapering to ⅜" (.48 cm)

- 27-224 SMILLIE Meniscus Hook Retractor 5¾" (14.6 cm), blade ¾" (1.9 cm) x 1⅝" (3.5 cm)

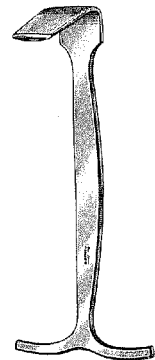

27-224

For additional Retractors see pages 151 - 187

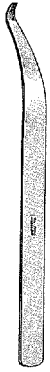

27-225



11-500

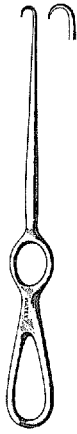

11-502



27-230
27-232

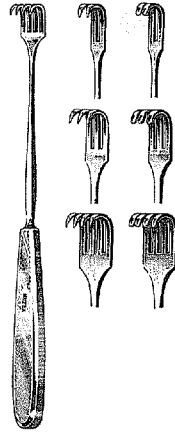

11-504 to 11-516

27-225 HAYS Hand and Finger Retractor 6" (15.2 cm), angled blade 1½" (3.8 cm) long, ⅜" (1 cm) wide tapering to ¼" (.32 cm)

11-500 VOLKMAN Hook 8½" (21.6 cm), sharp, hollow handle

11-502 VOLKMAN Hook 8½" (21.6 cm), sharp, ring handle

27-230 VOLKMAN Hook Retractor 9" (22.9 cm), sharp point 15 mm deep

27-232 VOLKMAN Hook Retractor 9" (22.9 cm), blunt tip 15 mm deep

VOLKMAN RETRACTORS 8½" (21.6 cm), hollow handle

	Sharp	Blunt
11-504	2 prongs	11-512
11-506	3 prongs	11-514
11-508	4 prongs	11-516

For additional Retractors see pages 151 - 187

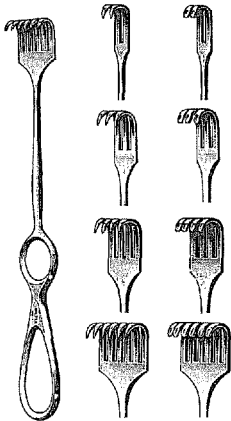

11-530 to 11-544

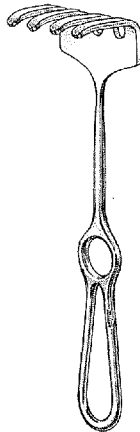

11-349

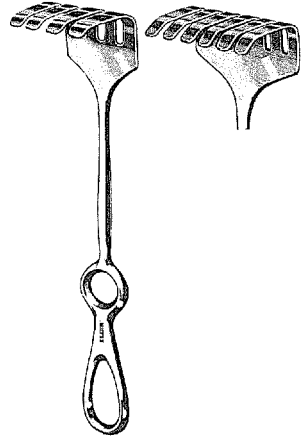

11-350
11-352

VOLKMAN RETRACTORS 8" (20.3 cm), Ring Handle

	Sharp	Blunt
11-530	2 prongs	11-538
11-532	3 prongs	11-540
11-534	4 prongs	11-542
11-536	6 prongs	11-544

11-349 OLLIER Rake Retractor 8½" (21.6 cm), blunt, 4 prongs
2¼" (5.7 cm) x 1¼" (4.4 cm)

11-350 ISRAEL Rake Retractor 9" (22.9 cm), blunt, 4 prongs
1½" (3.8 cm) x 1½" (4.1 cm)

11-352 ISRAEL Rake Retractor 9" (22.9 cm), blunt, 6 prongs
2¼" (5.7 cm) x 1¼" (4.4 cm)

For additional Retractors see pages 151 - 187



Orthopedic Instruments



27-260 to 27-264



27-270 to 27-274

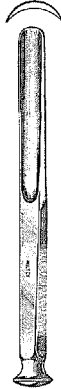

27-280
27-282



19-750 to 19-760



19-770 to 19-780

27-260	U.S. ARMY Pattern Chisel 6½" (16.5 cm), 6 mm wide
27-262	U.S. ARMY Pattern Chisel 6½" (16.5 cm), 12 mm wide
27-264	U.S. ARMY Pattern Chisel 6½" (16.5 cm), 18 mm wide
27-270	U.S. ARMY Pattern Osteotome 6½" (16.5 cm), 6 mm wide
27-272	U.S. ARMY Pattern Osteotome 6½" (16.5 cm), 12 mm wide
27-274	U.S. ARMY Pattern Osteotome 6½" (16.5 cm), 18 mm wide
27-280	U.S. ARMY Pattern Gouge 6½" (16.5 cm), 6 mm wide
27-282	U.S. ARMY Pattern Gouge 6½" (16.5 cm), 12 mm wide
19-750	ALEXANDER Chisel 7" (17.8 cm), 4 mm wide
19-752	ALEXANDER Chisel 7" (17.8 cm), 6 mm wide
19-754	ALEXANDER Chisel 7" (17.8 cm), 8 mm wide
19-756	ALEXANDER Chisel 7" (17.8 cm), 10 mm wide
19-758	ALEXANDER Chisel 7" (17.8 cm), 12 mm wide
19-760	ALEXANDER Chisel 7" (17.8 cm), 14 mm wide
19-770	ALEXANDER Gouge 7" (17.8 cm), 4 mm wide
19-772	ALEXANDER Gouge 7" (17.8 cm), 6 mm wide
19-774	ALEXANDER Gouge 7" (17.8 cm), 8 mm wide
19-776	ALEXANDER Gouge 7" (17.8 cm), 10 mm wide
19-778	ALEXANDER Gouge 7" (17.8 cm), 12 mm wide
19-780	ALEXANDER Gouge 7" (17.8 cm), 14 mm wide



27-331 to 27-336



27-418 to 27-432



27-438 to 27-452



27-438C to 27-452C

- 27-331 HOKE Osteotome 5½" (14 cm) straight ⅛" (.32 cm)
- 27-332 HOKE Osteotome 5½" (14 cm) straight ⅜" (.48 cm)
- 27-333 HOKE Osteotome 5½" (14 cm) straight ½" (.64 cm)
- 27-334 HOKE Osteotome 5½" (14 cm) straight ⅝" (.79 cm)
- 27-335 HOKE Osteotome 5½" (14 cm) straight ¾" (.95 cm)
- 27-336 HOKE Osteotome 5½" (14 cm) straight ⅞" (1.3 cm)

HIBBS CHISELS 9" (22.9 cm)

Straight	Size
27-418	¼" (.64 cm)
27-420	⅜" (.95 cm)
27-422	½" (1.3 cm)
27-424	⅝" (1.6 cm)
27-426	¾" (1.9 cm)
27-427	⅞" (2.2 cm)
27-428	1" (2.5 cm)
27-430	1¼" (3.2 cm)
27-432	1½" (3.8 cm)

HIBBS OSTEOTOMES 9" (22.9 cm)

Straight	Size	Curved
27-438	¼" (.64 cm)	27-438C
27-440	⅜" (.95 cm)	27-440C
27-442	½" (1.3 cm)	27-442C
27-444	⅝" (1.6 cm)	27-444C
27-446	¾" (1.9 cm)	27-446C
27-447	⅞" (2.2 cm)	27-447C
27-448	1" (2.5 cm)	27-448C
27-449	1⅛" (2.8 cm)	27-449C
27-450	1¼" (3.2 cm)	27-450C
27-452	1½" (3.8 cm)	27-452C



27-458 to 27-468



27-458C to 27-466C

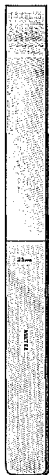

27-488 to 27-508



27-510 to 27-522



27-530 to 27-542



HIBBS GOUGES 9" (22.9 cm)

Straight	Size	Curved
27-458	1/4" (.64 cm)	27-458C
27-460	3/8" (.95 cm)	27-460C
27-462	1/2" (1.3 cm)	27-462C
—	5/8" (1.6 cm)	27-464C
27-466	3/4" (1.9 cm)	27-466C
27-468	1" (2.5 cm)	—

LAMBOTTE OSTEOTOMES 9" (22.9 cm)

Straight	Width	Curved
27-488	6 mm (1/4")	27-499
27-490	13 mm (1/2")	27-500
27-492	19 mm (3/4")	27-502
27-494	25 mm (1")	27-504
27-496	32 mm (1 1/4")	27-506
27-498	38 mm (1 1/2")	27-508

SMITH-PETERSEN OSTEOTOMES 8" (20.3 cm)

Straight	Width	Curved
27-510	1/4" (.64 cm)	27-530
27-512	3/8" (.95 cm)	27-532
27-514	1/2" (1.3 cm)	27-534
27-516	5/8" (1.6 cm)	27-536
27-518	3/4" (1.9 cm)	27-538
27-520	1" (2.5 cm)	27-540
27-522	1 1/4" (3.2 cm)	27-542



27-549 to 27-558



27-599 to 27-605

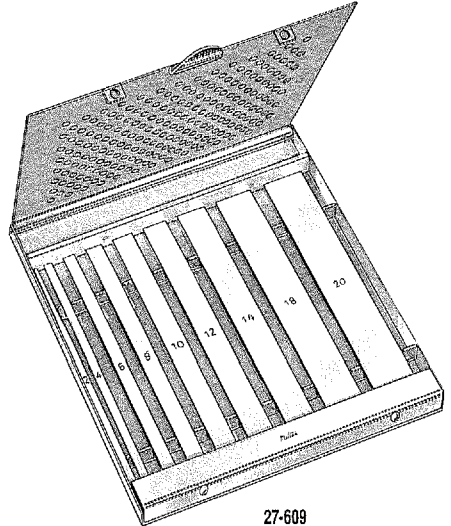

27-609
27-610

SMITH-PETERSEN GOUGES 8" (20.3 cm)

Straight	Width
27-549	¼" (.64 cm)
27-550	⅜" (.95 cm)
27-551	½" (1.3 cm)
27-553	⅝" (1.6 cm)
27-554	¾" (1.9 cm)
27-556	1" (2.5 cm)
27-558	1¼" (3.2 cm)

SWISS PATTERN OSTEOTOMES 5" (12.7 cm)

Width	Width
27-599	2 mm
27-600	4 mm
27-601	6 mm
27-601A	8 mm
27-602	10 mm
26-602A	12 mm
27-603	14 mm
27-604	18 mm
27-605	20 mm

27-609 Sterilizer – Storage Case 5½" (14 cm) x 6½" (16.5 cm) x ½" (1.3 cm), fitted to hold 9 Swiss Pattern Osteotomes 2 mm to 20 mm

27-610 Set of 9 Swiss Pattern Osteotomes 2 mm to 20 mm, complete in fitted Sterilizer Case



19-790

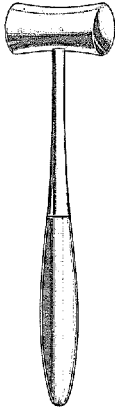

19-792

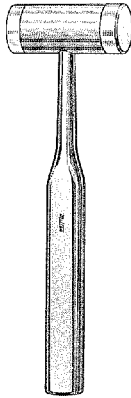

19-793

19-794

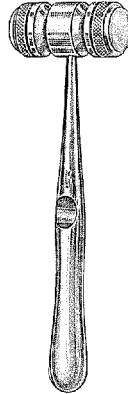

19-796

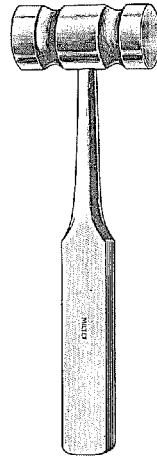

27-660

27-662

- 19-790 GERZOG Mallet 7½" (19.1 cm), head 8 oz. (227 g) lead filled with stainless jacket
- 19-792 LUCAE Mallet 7½" (19.1 cm), head 9 oz. (255 g) solid stainless
- 19-793 MILTEX Mallet 7½" (19.1 cm), lightweight 7.5 oz. (213 g), stainless head 1" (2.5 cm) dia. with 2 replaceable nylon caps
- 19-794 MILTEX Mallet 7½" (19.1 cm), lightweight 9 oz. (255 g), stainless head 1" (2.5 cm) dia. with 1 stainless face and 1 replaceable nylon cap
- 19-795 Nylon Cap Replacement for Nos. 19-793 and 19-794 Mallets
- 19-796 MEAD Mallet 7½" (19.1 cm), head 8 oz. (227 g), with 2 replaceable nylon caps
- 19-797 Nylon Cap Replacement for No. 19-796 Mallet
- 27-660 MILTEX Mallet 11" (27.9 cm), head 16 oz. (454 g) solid stainless
- 27-662 MILTEX Mallet 11" (27.9 cm), head 32 oz. (908 g) solid stainless



27-680



27-700



27-702



27-703



26-1410



26-1412

- 27-680 MURPHY-LANE Bone Skid 12" (30.5 cm)
- 27-700 PUTTI Bone Rasp 10½" (26.7 cm), flat ends, one side curved on flat, other side curved sideways
- 27-702 PUTTI Bone Rasp 12" (30.5 cm), round and half-round tapered curved ends
- 27-703 Bone File 9¾" (24.8 cm), bayonet shank, half-round blade 3½" (8.9 cm) x ½" (1.3 cm)
- 26-1410 LANGENBECK Periosteal Elevator 7½" (19.1 cm), narrow model, 7 mm wide blunt blade
- 26-1412 LANGENBECK Periosteal Elevator 7½" (19.1 cm), wide model, 17 mm wide sharp blade
- 25-28 SEDILLOT Periosteal Elevator 7½" (19.1 cm), blade 17 mm wide



25-28



27-744
27-746



27-747 to 27-750



27-752



27-753



27-754



27-820 to 27-826

- 27-744** SAYRE Periosteal Elevator 6 $\frac{3}{4}$ " (17.1 cm), one straight blunt and one curved sharp end
27-746 SAYRE Periosteal Elevator 6 $\frac{3}{4}$ " (17.1 cm), one straight blunt and one curved blunt end
- 27-747** CHANDLER Elevator 7 $\frac{1}{2}$ " (19.1 cm), blade $\frac{1}{2}$ " (1.3 cm) tapering to $\frac{5}{16}$ " (.79 cm)
27-748 CHANDLER Elevator 8" (20.3 cm), blade $\frac{3}{4}$ " (1.9 cm) tapering to $\frac{1}{2}$ " (1.3 cm)
27-749 CHANDLER Elevator 9 $\frac{1}{4}$ " (23.5 cm), blade 1" (2.5 cm) tapering to $\frac{1}{16}$ " (1.7 cm)
27-750 CHANDLER Elevator 10" (25.4 cm), blade 1 $\frac{1}{4}$ " (3.2 cm) tapering to $\frac{3}{4}$ " (1.9 cm)
- 27-752** CREGO Periosteal Elevator 8" (20.3 cm), slightly curved blade 7 mm
27-753 CREGO Periosteal Elevator 8" (20.3 cm), fully curved blade 7 mm
27-754 CREGO Periosteal Elevator 8" (20.3 cm), fully curved blade 14 mm
- 27-820** KEY Periosteal Elevator 7" (17.8 cm), $\frac{1}{4}$ " (.64 cm) wide
27-821 KEY Periosteal Elevator 7 $\frac{1}{2}$ " (19.1 cm), $\frac{3}{8}$ " (.95 cm) wide
27-822 KEY Periosteal Elevator 7 $\frac{1}{2}$ " (19.1 cm), $\frac{1}{2}$ " (1.3 cm) wide
27-824 KEY Periosteal Elevator 8" (20.3 cm), $\frac{3}{4}$ " (1.9 cm) wide
27-826 KEY Periosteal Elevator 8 $\frac{1}{4}$ " (21 cm), 1" (2.5 cm) wide

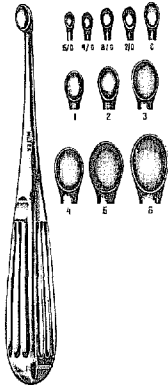

19-700 to 19-720



26-1627 to 26-1640

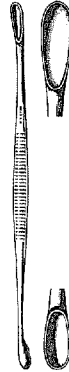

27-920

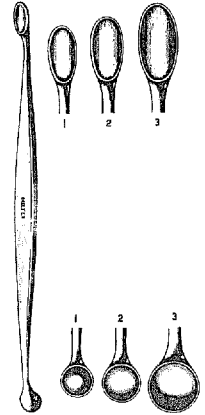

27-924
27-926
27-928

SPRATT (BRUN) BONE CURETTES, Oval Cups

6½" (16.5 cm) Long		9" Long (22.9 cm)	
19-700	Size 5/0	26-1627	Size 3/0
19-702	Size 4/0	26-1628	Size 2/0
19-704	Size 3/0	26-1629	Size 0
19-706	Size 2/0	26-1630	Size 1
19-708	Size 0	26-1632	Size 2
19-710	Size 1	26-1634	Size 3
19-712	Size 2	26-1636	Size 4
19-714	Size 3	26-1638	Size 5
19-716	Size 4	26-1640	Size 6
19-718	Size 5		
19-720	Size 6		

VOLKMAN DOUBLE END CURETTES

27-920	5½" (14 cm) long, oval cups 5 x 10 mm and 6 x 20 mm
27-924	5" (12.7 cm) long, oval cup 6 x 10 mm and round cup 7 mm dia.
27-926	6½" (16.5 cm) long, oval cup 8 x 14 mm and round cup 10 mm dia.
27-928	8" (20.3 cm) long, oval cup 9 x 18 mm and round cup 11 mm dia.



21-321



21-322



27-970



27-972
27-974



27-980

- 21-321 MARTINI Bone Curette 5½" (14 cm), double end, 4 mm and 5 mm round cups
- 21-322 WILLIGER Bone Curette 5½" (14 cm), double end, 3 mm and 4 mm oval cups
- 27-970 SMILLIE Meniscus Knife 7¼" (18.4 cm), straight chisel blade
- 27-972 SMILLIE Meniscus Knife 7" (17.8 cm), curved left
- 27-974 SMILLIE Meniscus Knife 7" (17.8 cm), curved right
- 27-980 LOWE-BRECK Cartilage Knife 10½" (26.7 cm), straight edge with guards
- 27-984 DOWNING Cartilage Knife 10" (25.4 cm), concave edge with guards

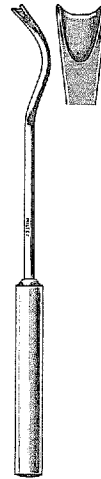

27-984

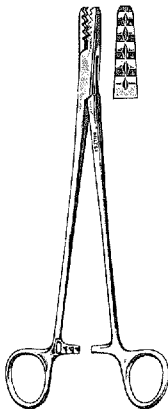

27-990
27-992



27-1000

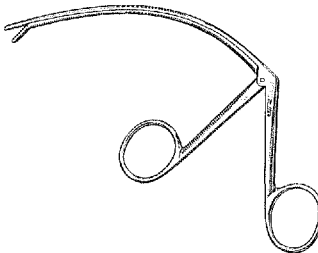

27-1016

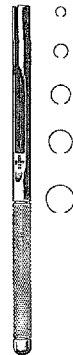

27-1020 to 27-1028

- 27-990 MARTIN Cartilage Clamp 7" (17.8 cm)
- 27-992 MARTIN Cartilage Clamp 8" (20.3 cm)
- 27-1000 MARTIN Cartilage Scissors 8" (20.3 cm), serrated non-slip cutting edges
- 27-1016 MILTEX Tendon Pulling Forceps, 5" (12.7 cm) curved shaft, alligator type
- 27-1020 BUNNELL Tendon Stripper 6" (15.2 cm), inside dia. 3 mm
- 27-1022 BUNNELL Tendon Stripper 6" (15.2 cm), inside dia. 4 mm
- 27-1024 BUNNELL Tendon Stripper 6" (15.2 cm), inside dia. 5 mm
- 27-1026 BUNNELL Tendon Stripper 6" (15.2 cm), inside dia. 6 mm
- 27-1028 BUNNELL Tendon Stripper 6" (15.2 cm), inside dia. 7 mm

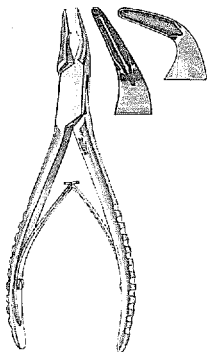

22-480 to 22-482

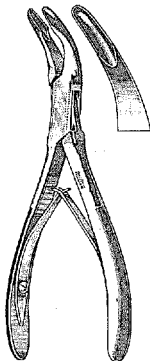

19-804

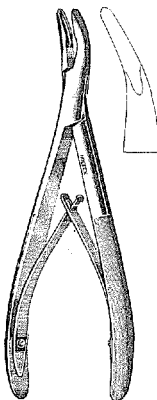

19-808

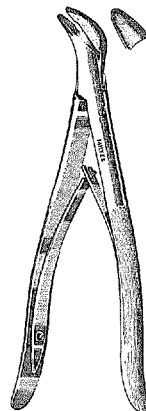

26-198

DEAN (BLUMENTHAL) RONGEURS 6" (15.2 cm),
3 x 10 mm bite tapered to 4 mm

22-480 slightly curved jaws

22-482 jaws 90° angled

22-481 CICHERELLI (REINER) Rongeur 7" (17.8 cm),
slightly curved jaws 3 x 8 mm bite tapered to 4 mm

19-804 HARTMAN Rongeur 5¾" (14.6 cm), strong curve,
4 x 12 mm bite

19-808 BANE Rongeur 7" (17.8 cm), curved jaws,
5 x 15 mm bite tapered to 7 mm

26-198 BACON Rongeur 8¼" (21 cm), angled on side,
5 mm bite

26-190 LUER Rongeur 7" (17.8 cm), straight jaws 8 mm bite

26-192 LUER Rongeur 7" (17.8 cm), curved jaws 8 mm bite

22D-420 BLUMENTHAL Rongeur 6" (15.2 cm), 45° angled jaws
3 x 12 mm bite

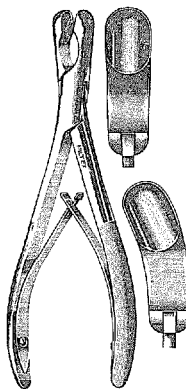

26-190 to 26-192

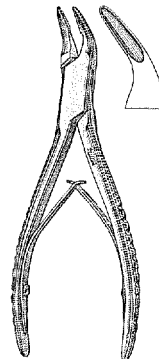

22D-420

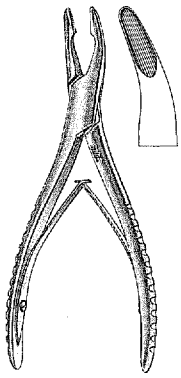

22-484

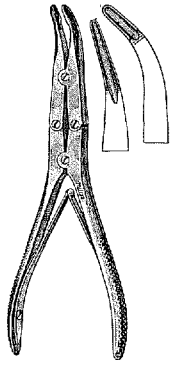

27-1295
27-1297

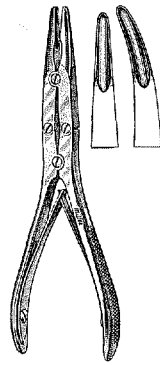

19-848
19-849

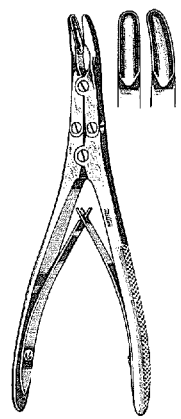

19-850 to 19-856

- 22-484 MEAD Rongeur 6½" (16.5 cm), slightly angled jaws 4 x 12 mm bite
- 27-1295 KLEINERT-KUTZ Bone Rongeur 6" (15.2 cm), slightly curved jaws 2 x 13 mm
- 27-1297 KLEINERT-KUTZ Synovectomy Rongeur 6" (15.2 cm), full curved jaws 3 x 8 mm

RUSKIN RONGEURS

Straight	Sizes	Curved
19-848	6" (15.2 cm) long, 3 mm bite	19-849
19-850	7¼" (18.4 cm) long, 5 mm bite	19-852
19-854	7¼" (18.4 cm) long, 7 mm bite	19-856

- 19-840 ZAUFEL-JANSEN Rongeur 7" (17.8 cm), slightly curved jaws 5 mm wide

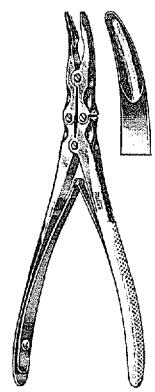

19-840

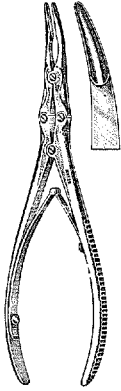

19-844

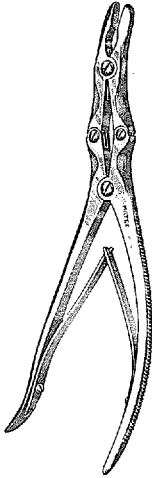

25-510
25-511

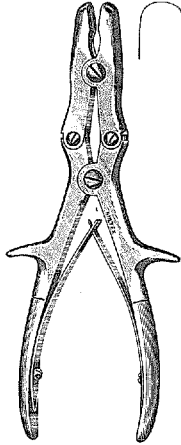

25-454

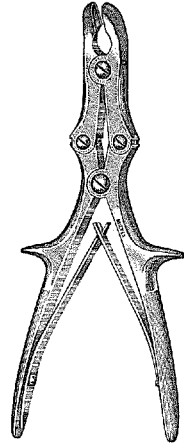

25-456

- 19-844 BEYER Rongeur 7" (17.8 cm), slightly curved jaws 3.5 mm wide
- 25-510 LEKSELL Laminectomy Rongeur 9½" (24.1 cm), standard curve, 3 mm bite
- 25-511 LEKSELL Laminectomy Rongeur 9½" (24.1 cm), standard curve, 8 mm bite
- 25-454 STILLE-LUER Rongeur 8¾" (22.2 cm), straight jaws 9 x 15 mm
- 25-456 STILLE-LUER Rongeur 8¾" (22.2 cm), curved jaws 9 x 15 mm
- 25-458 STILLE-LUER Duckbill Rongeur 9" (22.9 cm), angled on side jaws 6 x 12 mm

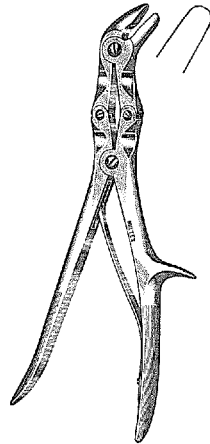

25-458

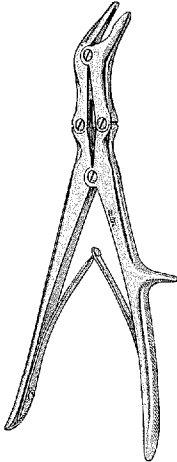

26-264 to 26-266

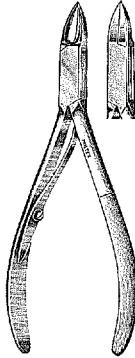

40-227-SS

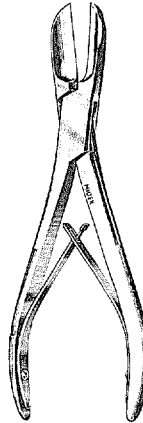

27-1390 to 27-1394

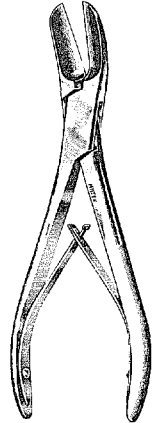

27-1400 to 27-1404

- 26-264** ECHLIN Duckbill Rongeur 9" (22.9 cm), 2 mm bite
26-265 ECHLIN Duckbill Rongeur 9" (22.9 cm), 3 mm bite
26-266 ECHLIN Duckbill Rongeur 9" (22.9 cm), 4 mm bite
40-227-SS LITTAUER-LISTON Bone Cutting Forceps 6" (15.2 cm), straight 20 mm blades

LISTON BONE CUTTING FORCEPS

Straight	Size	Angled on Flat
27-1390	5½" (14 cm)	27-1400
27-1392	7½" (19.1 cm)	27-1402
27-1394	8½" (21.6 cm)	27-1404

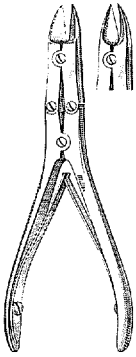

21-626
21-627

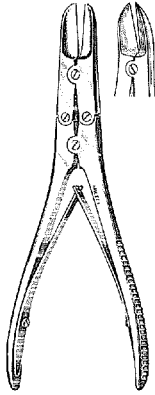

25-384
25-385

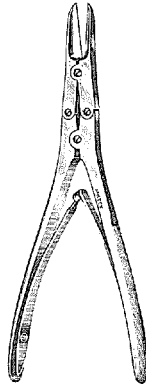

21-628

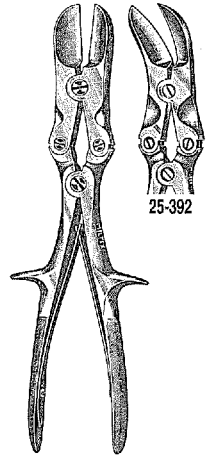

25-390

25-392

RUSKIN BONE CUTTING FORCEPS

Straight

Size

Angled

21-626

standard blades 5½" (14 cm)

21-627

25-384

standard blades 7½" (19.1 cm)

25-385

21-628

delicate blades 7½" (19.1 cm)

25-390

STILLE-LISTON Bone Cutting Forceps 10¾" (27.3 cm), straight

25-392

STILLE-LISTON Bone Cutting Forceps 10¾" (27.3 cm), curved

25-396

STILLE-HORSLEY Bone Cutting Forceps 10½" (26.7 cm),
angled blades

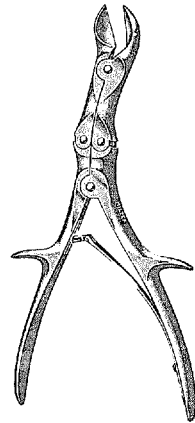

25-396

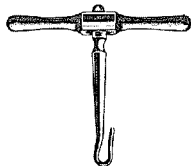

26-119

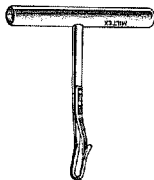

26-120

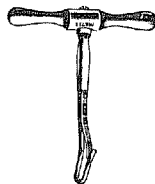

26-122

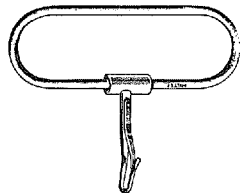

26-124

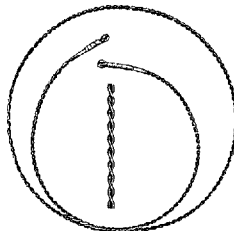

26-130 to 26-134

26-119 GIGLI Saw Handle, Standard Pattern, T-shape, turnable

26-120 GIGLI-STRULLY Saw Handle, T-shape, rigid, with snap lock

26-122 GIGLI-STRULLY Saw Handle, T-shape, turnable, with snap lock

26-124 GIGLI-STRULLY Saw Handle, Loop Grip, rigid, with snap lock

26-130 GIGLI Saw 12" (30.5 cm), standard twisted wire type

26-132 GIGLI Saw 20" (50.8 cm), standard twisted wire type

26-134 GIGLI Saw 30" (76.2 cm), standard twisted wire type

26-138 BAILEY Gigli Saw Guide 12" (30.5 cm), flexible

65-28 Mesh Holder, 6 $\frac{3}{4}$ " (17.1 cm), 2 $\frac{1}{4}$ " (5.4 cm) inside diameter of basket, securely holds small items such as micro clips, screws, burs etc., during cleaning, rinsing or sterilization



26-138

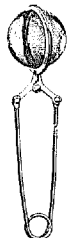

65-28



27-1550



40-2000

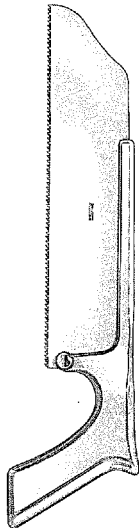

27-1560

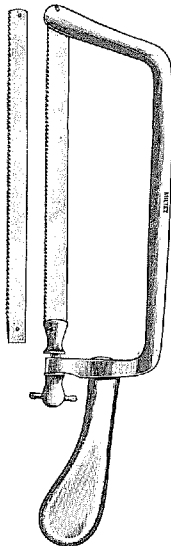

27-1564
27-1565-12
27-1565-18



27-1600
27-1602

- 27-1550** LANGENBECK Metacarpal Saw 9¼" (23.5 cm), blade 4½" (11.4 cm) long
- 40-2000** MILTEX Bone Saw 6" (15.2 cm), blade 2" (5.1 cm)
- 27-1560** SATTERLEE Bone Saw 12" (30.5 cm), light metal handle with stainless 9" (22.9 cm) blade
- 27-1561** Blade for No. 27-1560 Satterlee Saw
- 27-1564** CHARRIERE Bone Saw 14" (35.6 cm), with one each 12 mm and 18 mm stainless blades
- 27-1565-12** 12 mm wide blade for No. 27-1564 saw
- 27-1565-18** 18 mm wide blade for No. 27-1564 saw
- 27-1600** LISTON Amputating Knife 11¾" (29.8 cm), with 6½" (16.5 cm) blade
- 27-1602** LISTON Amputating Knife 13¾" (34.9 cm), with 8" (20.3 cm) blade



27-3002



27-3004

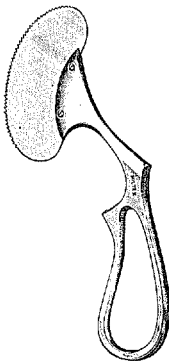

27-3020

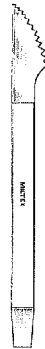

27-3022

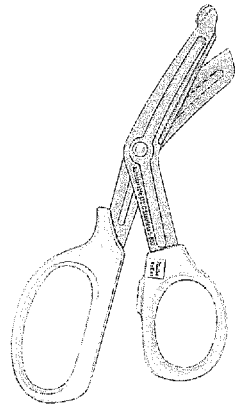

5-800

27-3002 U.S. Pattern Cast Knife 5½" (14 cm), wood handle, 1½" (3.8 cm) blade

27-3004 REINER Cast Knife 7" (17.8 cm), metal handle, 1½" (3.8 cm) blade

27-3020 ENGEL Cast Saw 6" (15.2 cm)

27-3022 WIGMORE Cast Saw 7¾" (19.7 cm)

5-800 Bandage and Utility Scissors 8½" (21.6 cm), with fluoride coated blades to help prevent adhesive or fiberglass casting material from sticking to the blade surfaces. Neon green plastic finger rings, serrated blade. Autoclavable.

5-998 Utility and Light Cast Shears 6½" (16.5 cm), black plastic finger rings, serrated blade. Autoclavable.

5-1000 Utility and Light Cast Shears 7½" (19.1 cm), black plastic finger rings, serrated blade. Autoclavable.

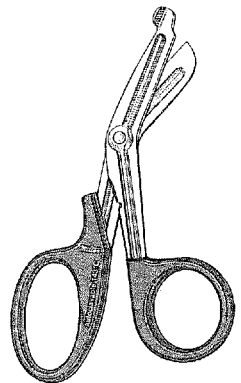

5-998
5-1000

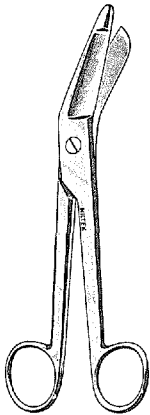

5-568

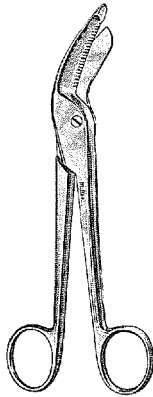

5-547

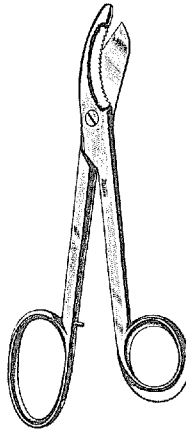

27-3070

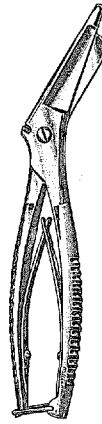

5-600

- 5-568 ESMARCH Cast Shears 8" (20.3 cm)
- 5-547 HERCULES Cast Shears 7½" (19.1 cm), serrated blade
- 27-3070 BRUNS Cast Shears 9¼" (23.5 cm), serrated blade
- 5-600 MILTEX Cast and Utility Shears 8½" (21.6 cm), with wire cutter and serrated blade
- 27-3059 STILLE Cast Shears 8" (20.3 cm), Pediatric Size, serrated blades
- 27-3060 STILLE Cast Shears 11" (27.9 cm), Medium Size, serrated blades
- 27-3062 STILLE Cast Shears 15" (38.1 cm), Standard Size, serrated blades

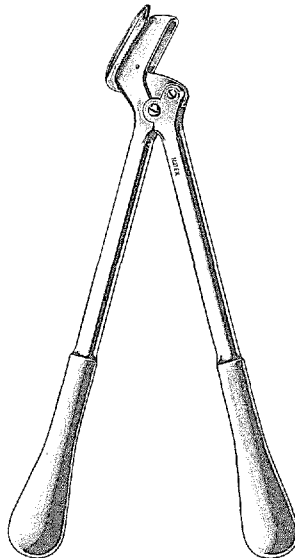

27-3059 to 27-3062

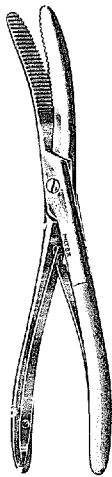

27-3080

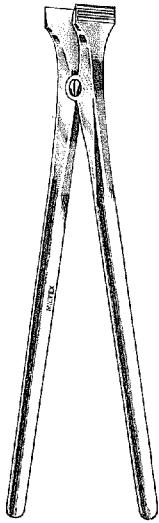

27-3090

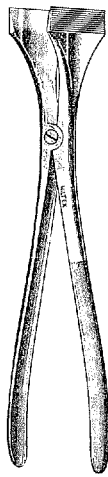

27-3094

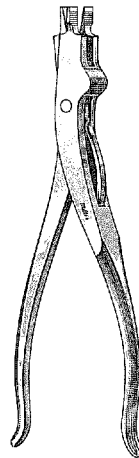

27-3100

- 27-3080 WOLFE-BOEHLER Cast Breaker 10" (25.4 cm), jaws 15 mm wide with deep serrations
- 27-3090 BEESON Cast Spreader 12" (30.5 cm), blades 2" (5.1 cm) wide
- 27-3094 HENNIG Cast Spreader 11" (27.9 cm), blades 2" (5.1 cm) wide
- 27-3100 MILTEX 3-Prong Cast Spreader 9" (22.9 cm), with spring action for one-hand operation

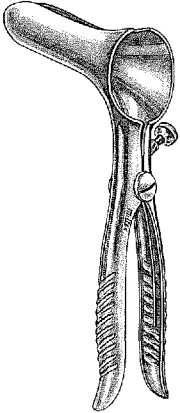

28-1

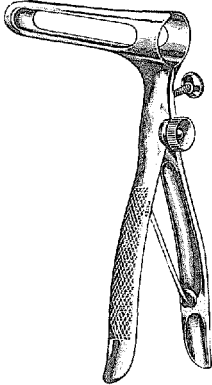

28-2

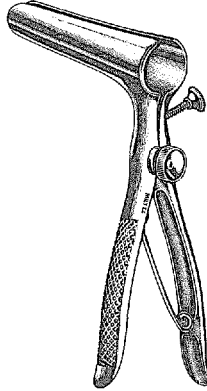

28-4

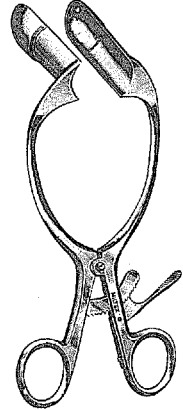

28-6

- 28-1 PRATT Rectal Speculum 8½" (21.6 cm) long, with set screw, blades 3½" (8.9 cm) long x 1" (2.5 cm) wide at distal end
- 28-2 SIMS Rectal Speculum 6" (15.2 cm) long, with set screw, fenestrated blades 3½" (8.9 cm) long x ⅝" (1.6 cm) wide at distal end
- 28-4 BODENHAMMER Rectal Speculum 6" (15.2 cm) long, with set screw, blades 3½" (8.9 cm) long x ¾" (1.9 cm) wide at distal end
- 28-6 BARR Anal Retractor 8" (20.3 cm), self-retaining, blades 2¾" (7 cm) x ⅞" (2.2 cm)

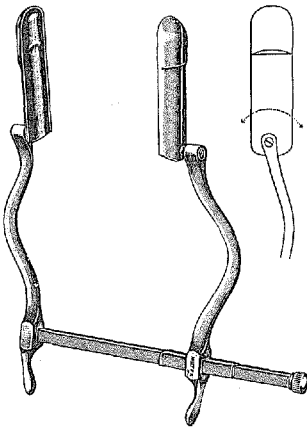

28-64
28-65



28-70 to 28-74

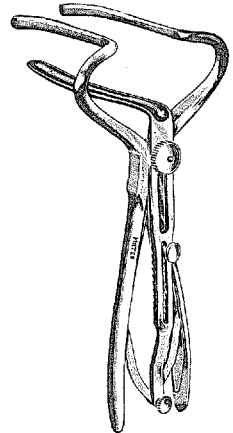

28-8

- 28-64** SMITH (BUIE) Anal Retractor, self-retaining, swivel blades $2\frac{1}{2}$ " (6.4 cm) x $\frac{7}{8}$ " (2.2 cm) open to 4" (10.2 cm)
- 28-65** SMITH (BUIE) Anal Retractor, self-retaining, extra long swivel blades 4" (10.2 cm) x $\frac{7}{8}$ " (2.2 cm) open to 4" (10.2 cm)
- 28-70** SAWYER Rectal Retractor 11" (27.9 cm), blade $\frac{7}{8}$ " (2.2 cm) x $2\frac{1}{2}$ " (6.4 cm)
- 28-72** SAWYER Rectal Retractor 11" (27.9 cm), blade $1\frac{1}{8}$ " (2.8 cm) x 3" (7.6 cm)
- 28-74** SAWYER Rectal Retractor 11" (27.9 cm), blade $1\frac{1}{2}$ " (3.8 cm) x $3\frac{1}{2}$ " (8.9 cm)
- 28-8** COOK Rectal Retractor 8" (20.3 cm), triple bladed, self-retaining, 4" (10.2 cm) deep blades, lower blade $\frac{1}{2}$ " (1.3 cm) wide

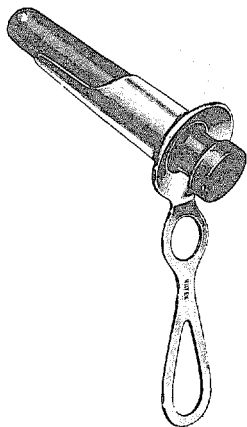

28-10

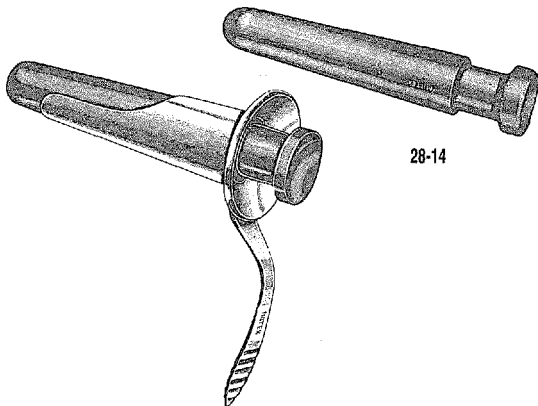

28-12

28-14

- 28-10 PENNINGTON Rectal Speculum $3\frac{3}{4}$ " (8.6 cm) long x 1" (2.5 cm) O.D., with boilable obturator, $4\frac{1}{4}$ " (12.1 cm) long handle, chrome
- 28-11 Obturator for No. 28-10 Pennington Speculum
- 28-12 FANSLER-IVES Rectal Speculum $3\frac{1}{4}$ " (8.3 cm) long x $1\frac{1}{8}$ " (2.8 cm) O.D., with boilable obturator, $2\frac{3}{4}$ " (7 cm) long handle, chrome
- 28-14 Obturator for No. 28-12 Fansler-Ives Speculum
- 28-20 HIRSCHMAN Anoscope, Small size $2\frac{1}{4}$ " (5.7 cm) long x $\frac{9}{16}$ " (1.4 cm) I.D.
- 28-22 HIRSCHMAN Anoscope, Medium size $2\frac{5}{8}$ " (6.7 cm) long x $1\frac{1}{16}$ " (1.7 cm) I.D.
- 28-24 HIRSCHMAN Anoscope, Large size $3\frac{1}{2}$ " (8.9 cm) long x $\frac{7}{8}$ " (2.2 cm) I.D.

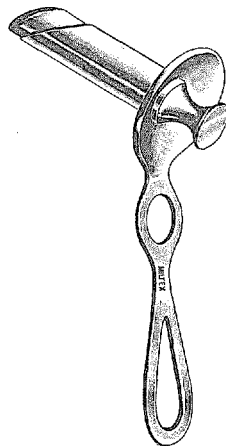

28-20 to 28-24

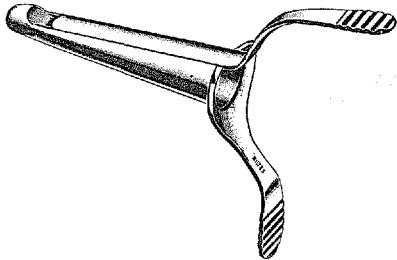

28-30 to 28-34

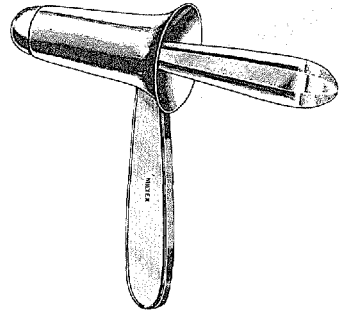

28-36
28-38

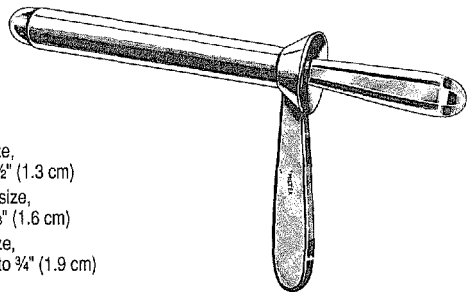

28-40
28-44

- 28-30 BRINKERHOFF Rectal Speculum, Small size,
3½" (8.9 cm) long x 1" (2.5 cm) tapering to ½" (1.3 cm)
- 28-32 BRINKERHOFF Rectal Speculum, Medium size,
4" (10.2 cm) long x 1" (2.5 cm) tapering to ¾" (1.6 cm)
- 28-34 BRINKERHOFF Rectal Speculum, Large size,
4¾" (12.1 cm) long x 1¼" (3.2 cm) tapering to ¾" (1.9 cm)
- 28-36 KELLY Sphincteroscope 2½" (5.4 cm) long x 1" (2.5 cm) O.D.
tapering to 1¾" (2.1 cm)
- 28-38 KELLY Sphincteroscope 2¼" (5.7 cm) long x 1¼" (3.2 cm) O.D.
tapering to 1" (2.5 cm)
- 28-40 KELLY Anoscope 2" (5.1 cm) long x 7⁄8" (2.2 cm) O.D.
- 28-44 KELLY Proctoscope 5½" (14 cm) long x 7⁄8" (2.2 cm) O.D.

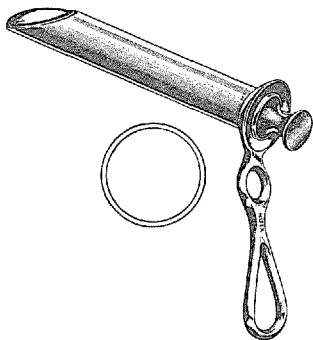

28-48

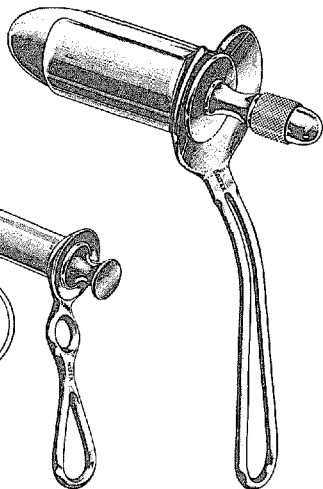

28-50

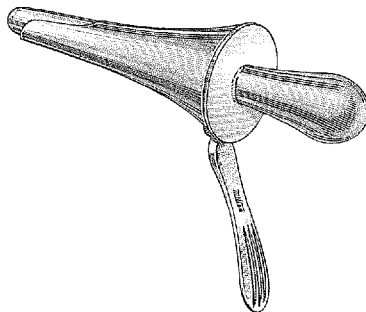

28-52

- 28-48 HIRSCHMAN Proctoscope 5" (12.7 cm)
long x $1\frac{5}{16}$ " (2.4 cm) O.D.
- 28-50 FANSLER Operating Speculum $2\frac{5}{8}$ " (6.1 cm)
long x $1\frac{3}{8}$ " (3.5 cm) O.D., slotted tube
- 28-52 BARR-SHUFORD Rectal Speculum $4\frac{1}{2}$ " (11.4 cm)
tapered from $\frac{5}{8}$ " (1.6 cm) to 2" (5.1 cm), chrome
- 28-68 HILL-FERGUSON Retractor $8\frac{1}{2}$ " (21.6 cm), small blade,
2.2 x 6.4 cm
- 28-69 HILL-FERGUSON Retractor $8\frac{3}{4}$ " (22.2 cm), large blade,
3 x 7.6 cm
- 28-79 CHELSEA EATON Anal Speculum $2\frac{5}{8}$ " (6.7 cm)
long x $\frac{7}{8}$ " (2.2 cm) O.D.
- 28-80 CHELSEA EATON Anal Speculum $2\frac{5}{8}$ " (6.7 cm)
long x $1\frac{1}{4}$ " (3.2 cm) O.D.

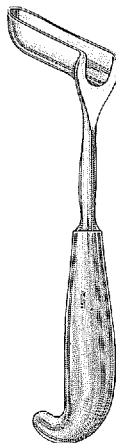

28-68
28-69

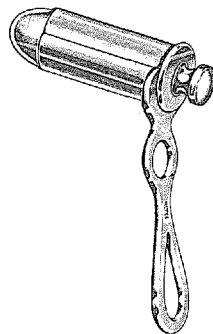

28-79
28-80

Rectal Instruments

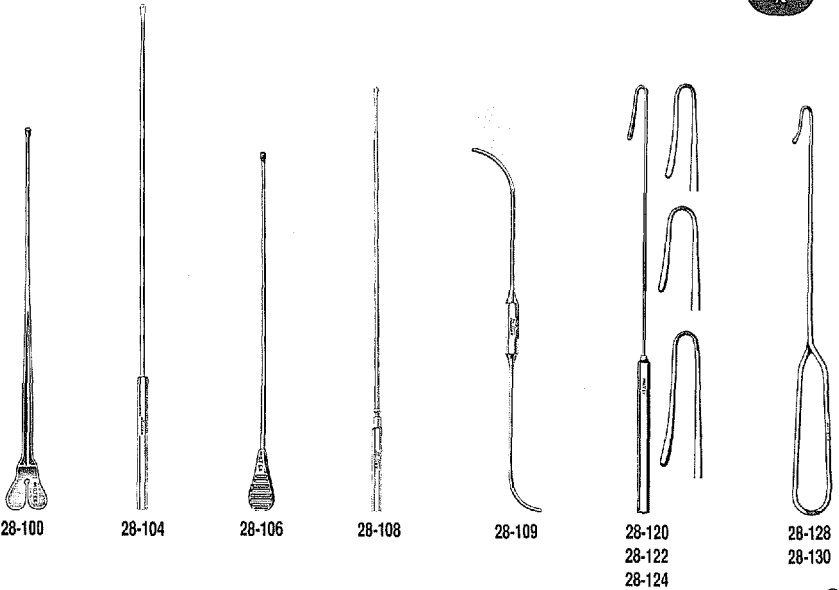

- 28-100 LARRY Probe and Grooved Director 7" (17.8 cm)
- 28-104 BARR Fistula Probe, with 8" (20.3 cm) sterling shaft, eye at tip, 11½" (29.2 cm) overall
- 28-106 BUIE Fistula Probe, with 5½" (14 cm) sterling shaft, 6¾" (17.1 cm) overall
- 28-108 PRATT Rectal Probe, with 7¾" (19.7 cm) sterling shaft, 11" (27.9 cm) overall
- 28-109 BARR Double Ended Probe 7" (17.8 cm), rigid
- 28-120 PRATT Crypt Hook 8½" (21.6 cm), narrow style
- 28-122 PRATT Crypt Hook 8½" (21.6 cm), short style
- 28-124 PRATT Crypt Hook 8½" (21.6 cm), long style
- 28-128 STEWART Crypt Hook 8½" (21.6 cm), short style
- 28-130 STEWART Crypt Hook 8½" (21.6 cm), long style
- 28-131 ROSSER Crypt Hook 6¾" (17.1 cm)
- 28-140 BARR Crypt Hook 10" (25.4 cm), short and long hook ends

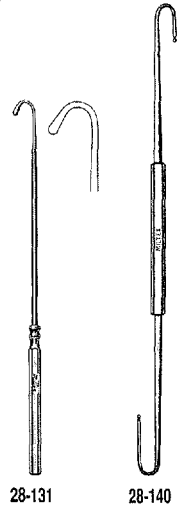



Rectal Instruments

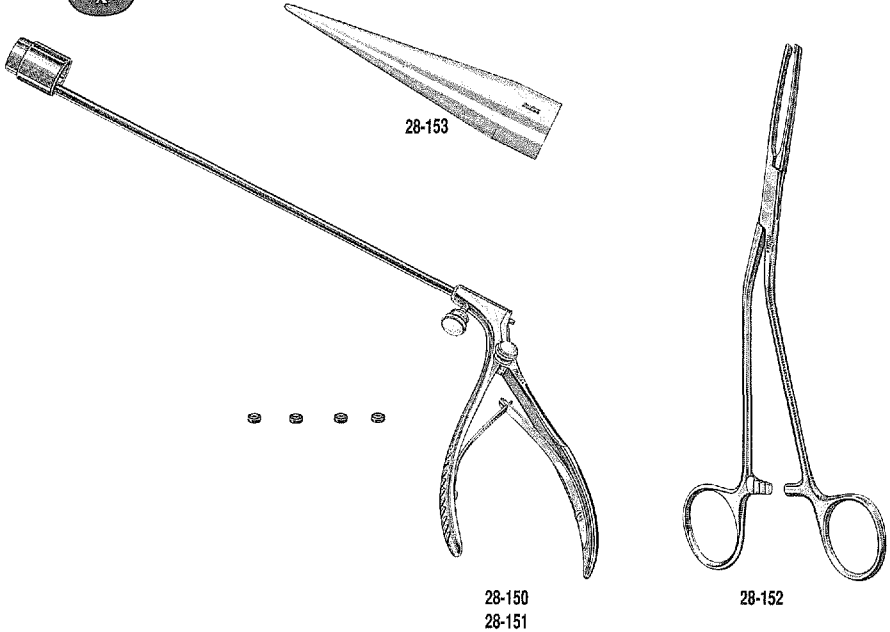

- 28-150** McGIVNEY Hemorrhoidal Ligator, improved model with offset handle for better vision and comfort. 7" (17.8 cm) working length. Can be disassembled entirely for cleaning. Supplied with drum loading cone and 100 Latex O-Rings.
- 28-151** Latex O-Rings for No. 28-150 Ligator. Bag with 100 rings.
- 28-152** McGIVNEY Hemorrhoid Grasping Forceps 7½" (19.1 cm), angled shanks. Specially designed for use with McGivney Ligator.
- 28-153** Loading Cone for No. 28-150 Ligator

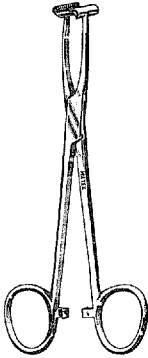

7-106

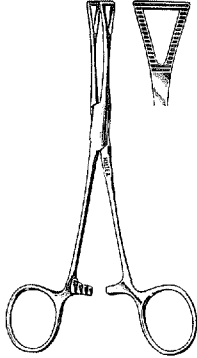

7-220

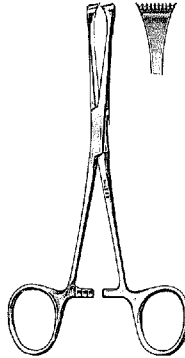

16-30

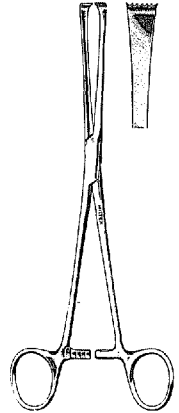

16-38

- 7-106 PRATT T-Shape Tissue Grasping Forceps 6" (15.2 cm)
- 7-220 PENNINGTON Tissue Grasping Forceps 6" (15.2 cm), triangular jaws
- 16-30 ADAIR-ALLIS Tissue Forceps 6½" (16.5 cm), 9 x 10 teeth
- 16-38 THOMS-ALLIS Tissue Forceps 8" (20.3 cm), 6 x 7 teeth



Rectal Instruments

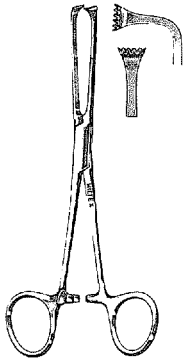

16-10
16-24

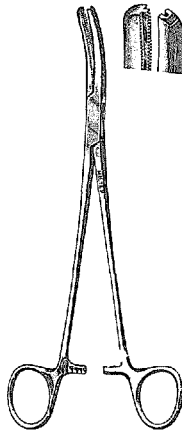

28-196

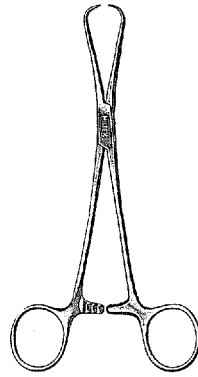

28-200

- 16-10 ALLIS Tissue Forceps 7¼" (18.4 cm), 5 x 6 teeth, straight
- 16-24 ALLIS Tissue Forceps 7¼" (18.4 cm), 5 x 6 teeth, 90° angled jaws
- 28-196 BUIE Pile Clamp 8½" (21.6 cm), curved angiotribe jaws
- 28-200 FERGUSON Tenaculum Forceps 6¾" (17.1 cm), straight jaws
- 7-260 FERGUSON Angiotribe Forceps 6½" (16.5 cm), straight
- 7-262 FERGUSON Angiotribe Forceps 6½" (16.5 cm), curved
- 7-264 FERGUSON Angiotribe Forceps 7½" (19.1 cm), straight
- 7-266 FERGUSON Angiotribe Forceps 7½" (19.1 cm), curved

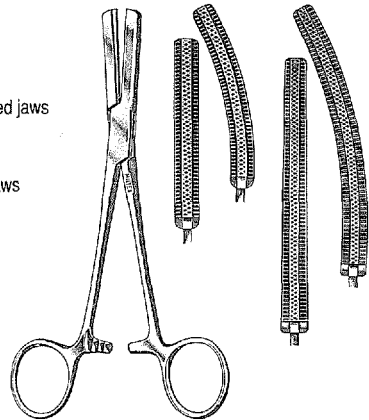

7-260 to 7-266

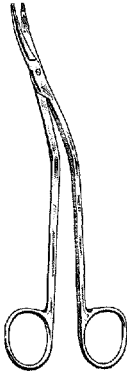

28-240

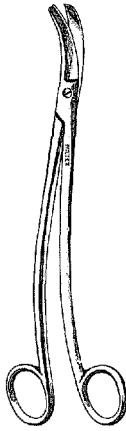

28-244

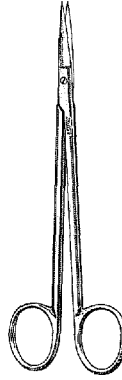

5-250
5D-251

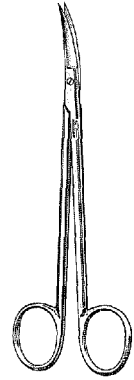

5-252
5D-253

- 28-240** MILLER Rectal Scissors 6¾" (17.1 cm), bayonet shape, delicate serrated blades with blunt points
- 28-244** PRATT Rectal Scissors 8¼" (21 cm), S-shaped, blunt points
- 5-250** KELLY Rectal Scissors 6¼" (15.9 cm), sharp points, straight
- 5D-251** KELLY Rectal Scissors 6¼" (15.9 cm), sharp points, straight, with one serrated blade
- 5-252** KELLY Rectal Scissors 6¼" (15.9 cm), sharp points, curved
- 5D-253** KELLY Rectal Scissors 6¼" (15.9 cm), sharp points, curved, with one serrated blade

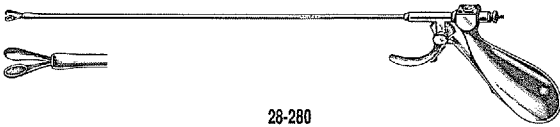

28-280

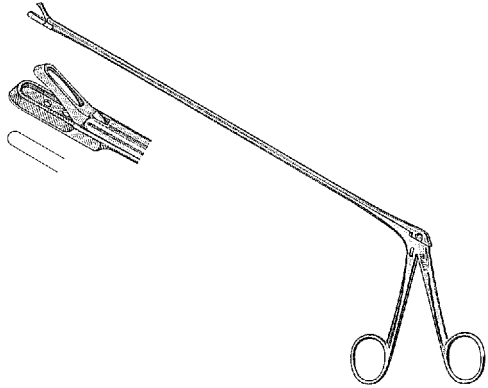

28-294 to 28-298

- 28-280 BUJE Biopsy Forceps 13" (33 cm) shaft, 3.5 mm bite
- 28-294 YEOMAN Biopsy Forceps 9" (22.9 cm) shaft, 3.5 x 10 mm bite, with basket
- 28-296 YEOMAN Biopsy Forceps 13" (33 cm) shaft, 3.5 x 10 mm bite, with basket
- 28-298 YEOMAN Biopsy Forceps 15" (38.1 cm) shaft, 3.5 x 10 mm bite, with basket

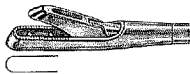

28-300
28-302
28-304
28-306
28-308
28-310



28-320
28-322
28-324
28-326
28-328
28-330

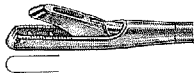

28-303
28-309

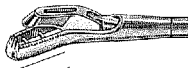

28-323
28-329

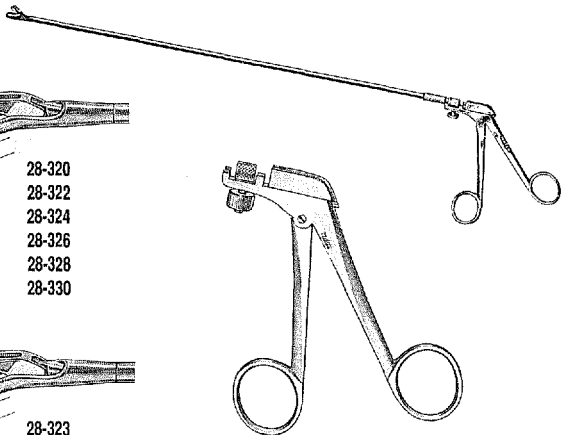

28-340

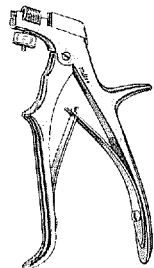

28-341

**YEOMAN BIOPSY FORCEPS with ROTATING SHAFTS,
Straight 4 x 8 mm Bite, With Basket**

Complete with Ring Handle	Shaft Length	Shaft Only
28-300	10" (25.4 cm)	28-306
28-302	14" (35.6 cm)	28-308
28-303	14" (35.6 cm) with teeth	28-309
28-304	16" (40.6 cm)	28-310

**TURRELL BIOPSY FORCEPS with ROTATING SHAFTS,
Angled Jaws 4 x 8 mm Bite, With Basket**

Complete with Ring Handle	Shaft Length	Shaft Only
28-320	10" (25.4 cm)	28-326
28-322	14" (35.6 cm)	28-328
28-323	14" (35.6 cm) with teeth	28-329
28-324	16" (40.6 cm)	28-330

28-340 Ring Handle fitting Yeoman and Turrell Biopsy Forceps Nos. 28-300 to 28-330

28-341 Pistol Grip Handle fitting Yeoman and Turrell Biopsy Forceps Nos. 28-300 to 28-330

NOTE: All parts of Nos. 28-300 through 28-341 are interchangeable



Rectal Instruments

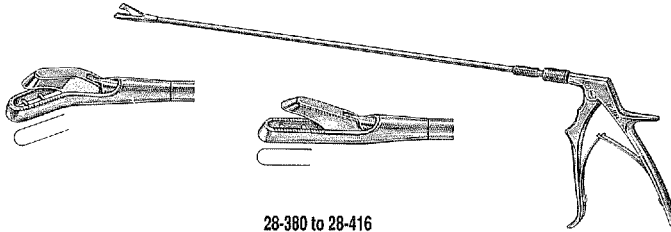

28-380 to 28-416

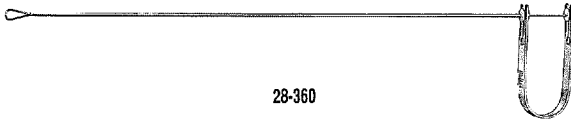

28-360

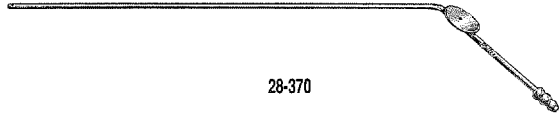

28-370

MILTEX IMPROVED BIOPSY FORCEPS with ROTATING SHAFTS in Pistol Grip Spring Handle. Shafts easily disassembled from handle. Constructed without small assembly parts. All shafts and handles are interchangeable.

Complete with Pistol Grip Handle	Shaft Length	Jaws	Shaft only
28-380	25.4 cm (10")	3.5 x 10 mm Bite straight	28-410
28-382	35.6 cm (14")	straight	28-412
28-384	25.4 cm (10")	angled	28-414
28-386	35.6 cm (14")	angled	28-416

28-400 Pistol Grip Spring Handle for Millex Improved Biopsy Forceps Nos. 28-380 through 28-416. This handle also fits Uterine Biopsy Forceps Nos. 30-1490 to 30-1495.

28-360 Rectal Cotton Carrier, 15" (38.1 cm) shaft, with spring action

28-370 BIUE Suction Tube 16" (40.6 cm), with finger valve, 15 Fr. (5 mm)

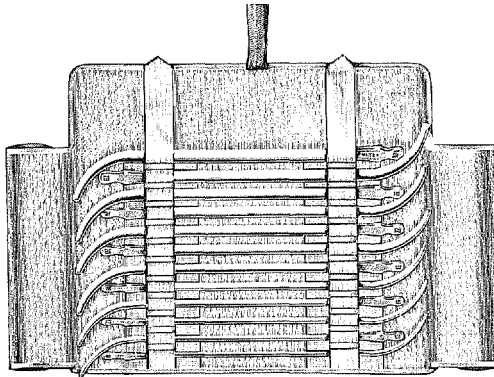

29-2
29-4



29-6



29-8

VAN BUREN URETHRAL SOUNDS 11" (27.9 cm)

29-2 Set of 6 Sounds in Khaki Roll, even sizes 14 Fr. (4.6 mm) to 24 Fr. (8 mm)

29-4 Set of 12 Sounds in Khaki Roll, even sizes 8 Fr. (2.6 mm) to 30 Fr. (10 mm)

29-6-8	8 Fr. (2.6 mm)	29-6-20	20 Fr. (6.6 mm)	29-6-32	32 Fr. (10.6 mm)
29-6-10	10 Fr. (3.3 mm)	29-6-22	22 Fr. (7.3 mm)	29-6-34	34 Fr. (11.2 mm)
29-6-12	12 Fr. (4 mm)	29-6-24	24 Fr. (8 mm)	29-6-36	36 Fr. (11.9 mm)
29-6-14	14 Fr. (4.6 mm)	29-6-26	26 Fr. (8.6 mm)	29-6-38	38 Fr. (12.5 mm)
29-6-16	16 Fr. (5.3 mm)	29-6-28	28 Fr. (9.2 mm)	29-6-40	40 Fr. (13.2 mm)
29-6-18	18 Fr. (6 mm)	29-6-30	30 Fr. (10 mm)		

DITTEL URETHRAL SOUNDS 11½" (29.2 cm), STRAIGHT

29-8-8	8 Fr. (2.6 mm)	29-8-18	18 Fr. (6 mm)	29-8-28	28 Fr. (9.2 mm)
29-8-10	10 Fr. (3.3 mm)	29-8-20	20 Fr. (6.6 mm)	29-8-30	30 Fr. (9.9 mm)
29-8-12	12 Fr. (4 mm)	29-8-22	22 Fr. (7.3 mm)	29-8-32	32 Fr. (10.6 mm)
29-8-14	14 Fr. (4.6 mm)	29-8-24	24 Fr. (8 mm)	29-8-34	34 Fr. (11.2 mm)
29-8-16	16 Fr. (5.3 mm)	29-8-26	26 Fr. (8.6 mm)		

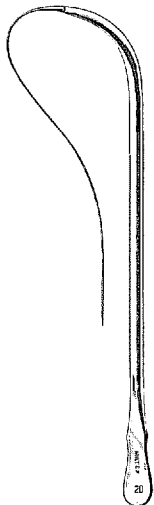

29-10



29-14



29-18

**LEFORT URETHRAL SOUNDS 11" (27.9 cm),
With Standard 1-56 Thread for Filiform (not included)**

29-10-8	8 Fr. (2.6 mm)	29-10-20	20 Fr. (6.6 mm)
29-10-10	10 Fr. (3.3 mm)	29-10-22	22 Fr. (7.3 mm)
29-10-12	12 Fr. (4 mm)	29-10-24	24 Fr. (8 mm)
29-10-14	14 Fr. (4.6 mm)	29-10-26	26 Fr. (8.6 mm)
29-10-16	16 Fr. (5.3 mm)	29-10-28	28 Fr. (9.2 mm)
29-10-18	18 Fr. (6 mm)	29-10-30	30 Fr. (10 mm)

MCCREA INFANT URETHRAL SOUNDS

7" (17.8 cm) CURVED, PLAIN TIP

Also used as Female Sounds

29-14-8	8 Fr. (2.6 mm)	29-14-24	24 Fr. (8 mm)
29-14-10	10 Fr. (3.3 mm)	29-14-26	26 Fr. (8.6 mm)
29-14-12	12 Fr. (4 mm)	29-14-28	28 Fr. (9.2 mm)
29-14-14	14 Fr. (4.6 mm)	29-14-30	30 Fr. (10 mm)
29-14-16	16 Fr. (5.3 mm)	29-14-32	32 Fr. (10.6 mm)
29-14-18	18 Fr. (6 mm)	29-14-34	34 Fr. (11.2 mm)
29-14-20	20 Fr. (6.6 mm)	29-14-36	36 Fr. (11.9 mm)
29-14-22	22 Fr. (7.3 mm)		

WALTHER URETHRAL SOUNDS 11" (27.9 cm)

Shaft Tapered Downward toward Handle

29-18-16	16 Fr. (5.3 mm)	29-18-28	28 Fr. (9.2 mm)
29-18-18	18 Fr. (6 mm)	29-18-30	30 Fr. (9.9 mm)
29-18-20	20 Fr. (6.6 mm)	29-18-32	32 Fr. (10.6 mm)
29-18-22	22 Fr. (7.3 mm)	29-18-34	34 Fr. (11.2 mm)
29-18-24	24 Fr. (8 mm)	29-18-36	36 Fr. (11.9 mm)
29-18-26	26 Fr. (8.6 mm)		



29-32



29-33

- 29-32-8 Female Catheter 5 $\frac{3}{4}$ " (14.6 cm), Size 8 Fr. (2.6 mm)
- 29-32-10 Female Catheter 5 $\frac{3}{4}$ " (14.6 cm), Size 10 Fr. (3.3 mm)
- 29-32-12 Female Catheter 5 $\frac{3}{4}$ " (14.6 cm), Size 12 Fr. (4 mm)
- 29-32-14 Female Catheter 5 $\frac{3}{4}$ " (14.6 cm), Size 14 Fr. (4.6 mm)
- 29-32-16 Female Catheter 5 $\frac{3}{4}$ " (14.6 cm), Size 16 Fr. (5.3 mm)
- 29-32-18 Female Catheter 5 $\frac{3}{4}$ " (14.6 cm), Size 18 Fr. (6 mm)

WALTHER FEMALE DILATOR-CATHETERS 5 $\frac{1}{4}$ " (13.3 cm)

- | | | |
|--------------------------|--------------------------|---------------------------|
| 29-33-12 12 Fr. (4 mm) | 29-33-22 22 Fr. (7.3 mm) | 29-33-32 32 Fr. (10.6 mm) |
| 29-33-14 14 Fr. (4.6 mm) | 29-33-24 24 Fr. (8 mm) | 29-33-34 34 Fr. (11.2 mm) |
| 29-33-16 16 Fr. (5.3 mm) | 29-33-26 26 Fr. (8.6 mm) | 29-33-36 36 Fr. (11.9 mm) |
| 29-33-18 18 Fr. (6 mm) | 29-33-28 28 Fr. (9.2 mm) | 29-33-38 38 Fr. (12.5 mm) |
| 29-33-20 20 Fr. (6.6 mm) | 29-33-30 30 Fr. (10 mm) | |



Urological Instruments



29-48



29-72

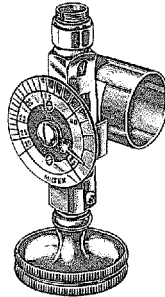

29-78

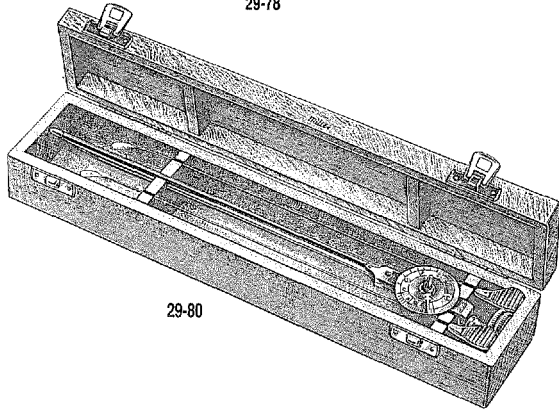

29-80

- 29-48** VAN BUREN Catheter Guide 17" (43.2 cm), size 8 Fr. (2.6 mm)
- 29-72** KOLLMANN Urethral Dilator 10" (25.4 cm), curved, dilates from 20 Fr. (6.6 mm) to 45 Fr. (14.9 mm), uses Handle No. 29-78
- 29-78** KOLLMANN Dilator Handle, adjustable from 20 Fr. (6.6 mm) to 45 Fr. (14.9 mm), for use with Dilator No. 29-72
- 29-80** OTIS Urethrotome, straight, with 2 knife blades, adjusts from 20 Fr. (6.6 mm) to 45 Fr. (14.9 mm) 11" (27.9 cm) working length. In fitted wooden case
- 29-81** OTIS Urethrotome Replacement Blade

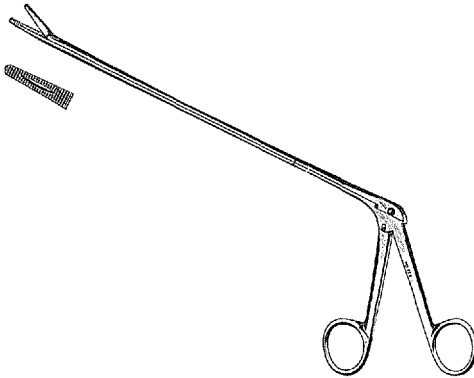

29-102

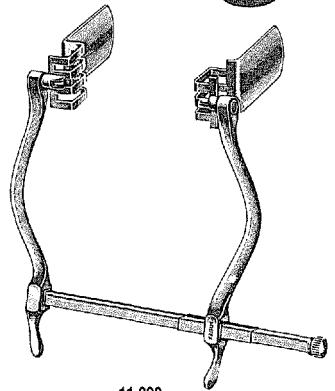

11-390

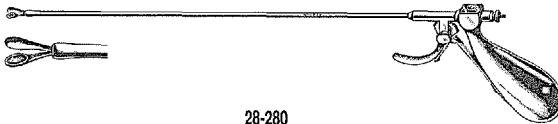

28-280

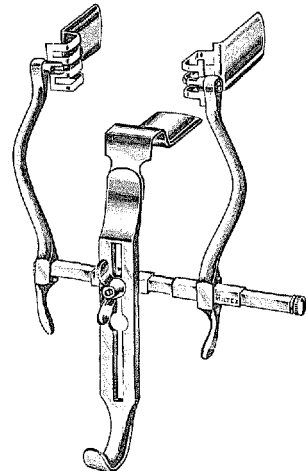

11-392

- 29-102 MATHIEU Urethral Forceps 11½" (29.2 cm) shaft, serrated jaws
3.5 mm x 17 mm
- 28-280 BRAASCH (BUIE) Bladder Biopsy Forceps 13" (33 cm) shaft,
3.5 mm cup jaws
- 11-390 MASSON-JUDD Bladder Retractor, with 2 swivel blades
1" (2.5 cm) x 2¾" (7 cm)
- 11-392 MASSON-JUDD Bladder Retractor, with 2 swivel blades
and center blade 1" (2.5 cm) x 2¾" (7 cm)

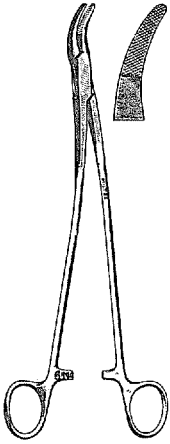

8-102

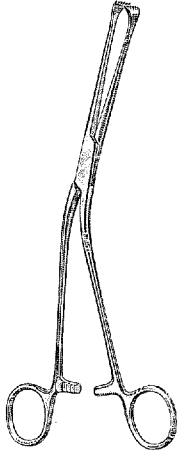

29-232

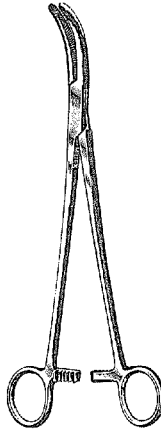

29-280

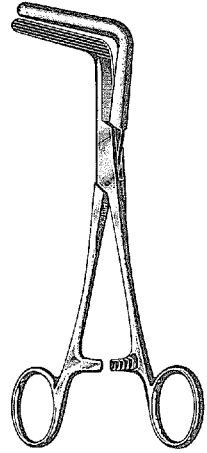

29-282

8-102 STRATTE Needle Holder 9" (22.9 cm), double curved jaws and bent shanks

29-232 MILLIN Capsule Holding Forceps 9½" (24.1 cm), jaws 11 mm wide, 9 x 10 teeth

29-280 WERTHEIM Pedicle Clamp 9¾" (24.8 cm), curved jaws 2" (5.1 cm) long

29-282 WERTHEIM-CULLEN Pedicle Clamp 8½" (21.6 cm), right angle jaws 2" (5.1 cm) long

29-284 RANDALL Kidney Stone Forceps 9¼" (23.5 cm), quarter curved

29-286 RANDALL Kidney Stone Forceps 8¼" (21 cm), half curved

29-288 RANDALL Kidney Stone Forceps 7¾" (19.7 cm), three quarter curved

29-290 RANDALL Kidney Stone Forceps 7½" (19.1 cm), full curved

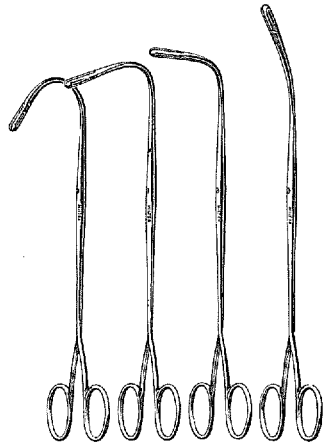

29-284 to 29-290

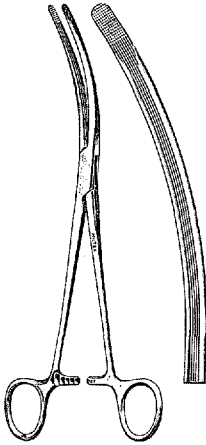

29-300

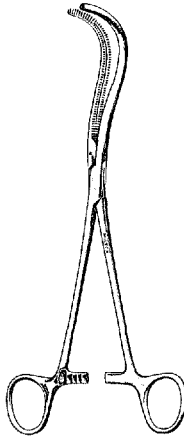

29-302

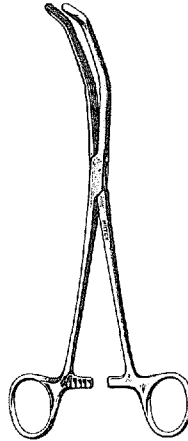

29-304

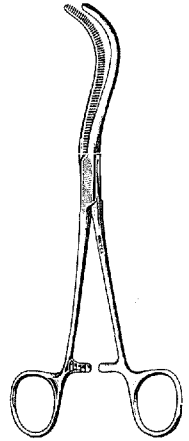

29-308

29-300 YOUNG Renal Pedicle Clamp 9" (22.9 cm), curved, longitudinal serrations with cross serrations at tip

29-302 STILLE Pattern Vessel Clamp 9" (22.9 cm)

29-304 HERRICK Kidney Pedicle Clamp 9½" (24.1 cm), double angle jaws, serrated

29-308 MAYO (GUYON) Vessel Clamp 9¼" (23.5 cm), double curved jaws, serrated

29-310TC BIHRLE Dorsal Clamp – Tungsten Carbide Needle Holder 11" (27.9 cm). Designed to aid in the fixation and suturing of the dorsal vein complex during retropubic prostatectomy for prostate cancer during cystectomy.

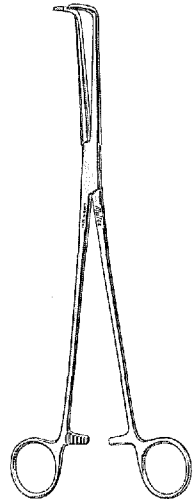

29-310TC

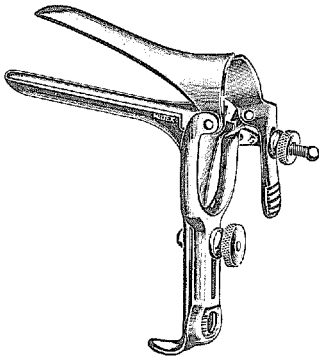

30-10 to 30-20

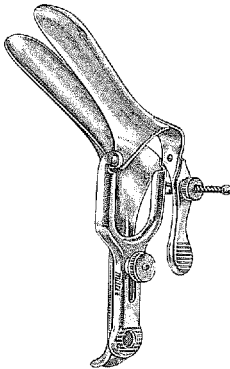

30-25

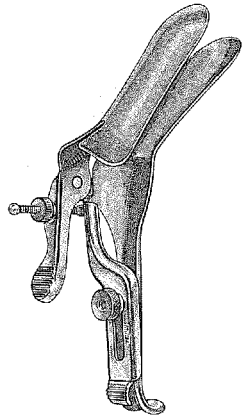

30-30

GRAVES VAGINAL SPECULA, ORIGINAL MODEL

30-10 Small Size, $\frac{3}{8}$ " (1.9 cm) x 3" (7.6 cm)

30-15 Medium Size $1\frac{1}{8}$ " (3.5 cm) x 4" (10.2 cm)

30-20 Large Size $1\frac{1}{2}$ " (3.8 cm) x $4\frac{1}{2}$ " (11.4 cm)

30-10B GRAVES Vaginal Speculum, Small Size $\frac{3}{8}$ " (1.9 cm) x 3" (7.6 cm), ebony finish

30-15B GRAVES Vaginal Speculum, Medium Size $1\frac{1}{8}$ " (3.5 cm) x 4" (10.2 cm), ebony finish

30-20B GRAVES Vaginal Speculum, Large Size $1\frac{1}{2}$ " (3.8 cm) x $4\frac{1}{2}$ " (11.4 cm), ebony finish

30-25 GRAVES Improved Vaginal Speculum, Medium Size $1\frac{1}{8}$ " (3.5 cm) x 4" (10.2 cm), wide angle blades

30-30 GRAVES Open Side Vaginal Speculum, Medium Size $1\frac{1}{8}$ " (3.5 cm) x 4" (10.2 cm), wide angle blades

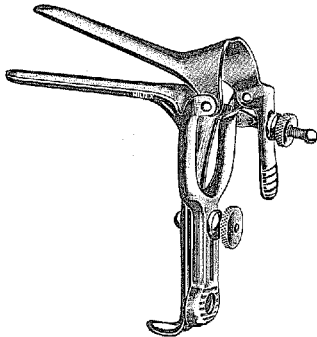

30-50 to 30-62

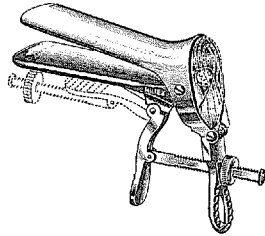

30-75 to 30-85

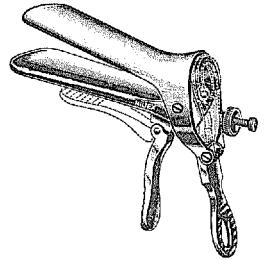

30-70
30-90 to 30-100

PEDERSON VAGINAL SPECULA, NARROW BLADES

30-50	Small Size,	$\frac{1}{2}$ " (1.3 cm) x 3" (7.6 cm)
30-55	Medium Size	$\frac{7}{8}$ " (2.2 cm) x 4" (10.2 cm)
30-60	Large Size	1" (2.5 cm) x 4 $\frac{1}{4}$ " (12.1 cm)
30-62	PEDERSON Extra Narrow Vaginal Speculum $\frac{5}{8}$ " (1.6 cm) x 4" (10.2 cm) blades	

CUSCO VAGINAL SPECULA, with Folding Handles

With Center Screw	Blade Sizes	With Side Screw
—	Extra Narrow	$\frac{3}{4}$ " (1.9 cm) x 3 $\frac{1}{4}$ " (8.3 cm)
30-75	Small	1 $\frac{1}{4}$ " (3.2 cm) x 3 $\frac{1}{2}$ " (8.9 cm)
30-80	Medium	1 $\frac{3}{8}$ " (3.5 cm) x 4" (10.2 cm)
30-85	Large	1 $\frac{1}{2}$ " (3.5 cm) x 4 $\frac{1}{2}$ " (11.4 cm)
		30-70
		30-90
		30-95
		30-100



Gynecological and Obstetrical Instruments

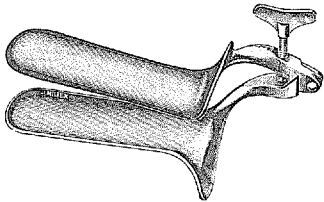

30-120 to 30-130

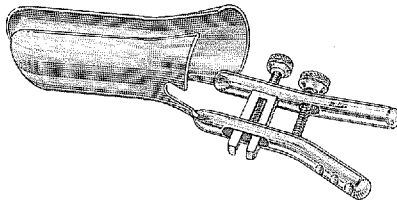

30-140 to 30-142

- 30-120 COLLIN Vaginal Speculum, Small Size 1¼" (3.2 cm) x 3¾" (9.5 cm)
- 30-125 COLLIN Vaginal Speculum, Medium Size 1¾" (3.5 cm) x 4" (10.2 cm)
- 30-130 COLLIN Vaginal Speculum, Large Size 1¾" (4.1 cm) x 4½" (11.4 cm)

DeVILBISS Vaginal Specula

Two sets of screws permit parallel, or bivalve opening of the blades, for examination or operative use

- 30-140 Small Size, 3½" (8.9 cm) x ¾" (2.2 cm) blades
- 30-141 Medium Size, 4" (10.2 cm) x 1¼" (3.2 cm) blades
- 30-142 Large Size, 5" (12.7 cm) x 1¾" (3.5 cm) blades
- 30-180 GUTMANN Vaginal Speculum, Examining Type, 1¾" (3.5 cm) x 4" (10.2 cm), self-retaining

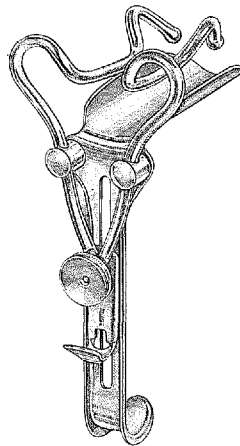

30-180

Gynecological and Obstetrical Instruments

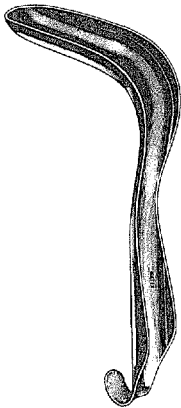

30-174 to 30-178

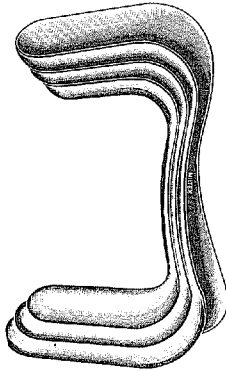

30-210 to 30-220

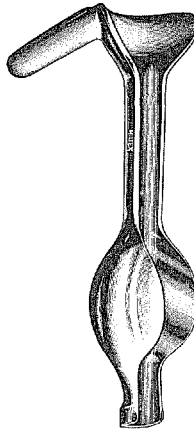

30-186 to 30-188

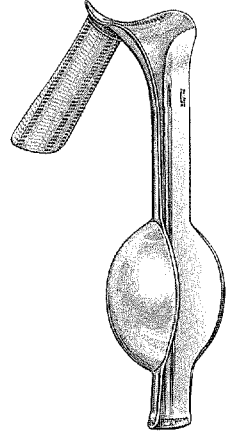

30-193

- 30-174** SIMS Vaginal Speculum, Single End, Small Size $1\frac{1}{16}$ " (2.7 cm) x $2\frac{1}{2}$ " (6.4 cm)
- 30-176** SIMS Vaginal Speculum, Single End, Medium Size $1\frac{1}{4}$ " (3.2 cm) x 3" (7.6 cm)
- 30-178** SIMS Vaginal Speculum, Single End, Large Size $1\frac{1}{2}$ " (3.8 cm) x $3\frac{1}{2}$ " (8.9 cm)
- 30-210** SIMS Vaginal Speculum, Double End, Small Size 1" (2.5 cm) x $2\frac{1}{2}$ " (6.4 cm) and $1\frac{1}{4}$ " (3.2 cm) x 3" (7.6 cm)
- 30-215** SIMS Vaginal Speculum, Double End, Medium Size $1\frac{1}{8}$ " (2.8 cm) x 3" (7.6 cm) and $1\frac{1}{4}$ " (3.2 cm) x $3\frac{1}{2}$ " (8.9 cm)
- 30-220** SIMS Vaginal Speculum, Double End, Large Size $1\frac{3}{8}$ " (3.5 cm) x $3\frac{1}{2}$ " (8.9 cm) and $1\frac{1}{2}$ " (3.8 cm) x 4" (10.2 cm)
- AUVARD WEIGHTED VAGINAL SPECULA 9" (22.9 cm)**
- 30-186** 2 lbs. (909 g), straight blade $1\frac{1}{2}$ " (3.8 cm) x $3\frac{1}{4}$ " (8.3 cm), slightly angled (75°)
- 30-187** 2.5 lbs. (1136 g), straight blade $1\frac{1}{2}$ " (3.8 cm) x $3\frac{1}{4}$ " (8.3 cm), slightly angled (75°)
- 30-188** 3 lbs. (1363 g), straight blade $1\frac{1}{2}$ " (3.8 cm) x $3\frac{1}{4}$ " (8.3 cm), slightly angled (75°)
- 30-193** 2.5 lbs. (1136 g), blade 4" (10.2 cm) long x $1\frac{3}{8}$ " (3.8 cm) wide, tapering to $1\frac{1}{4}$ " (4.4 cm) width at tip, blade at acute angle (45°)
- 30-195** STEINER-AUVARD weighted Vaginal Speculum, 2.5 lbs. (1136 g), slightly curved blade $5\frac{1}{2}$ " (14 cm) x $1\frac{1}{4}$ " (3.2 cm), at 90° angle

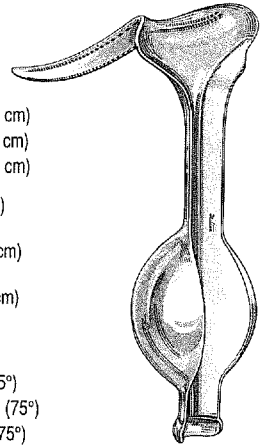

30-195



Gynecological and Obstetrical Instruments

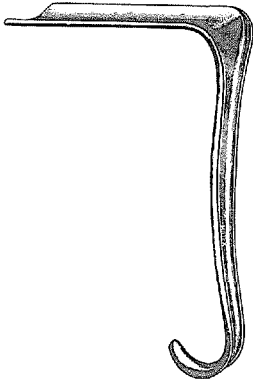

30-300 to 30-310

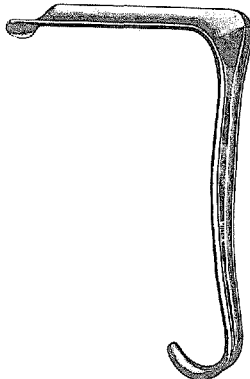

30-320 to 30-330

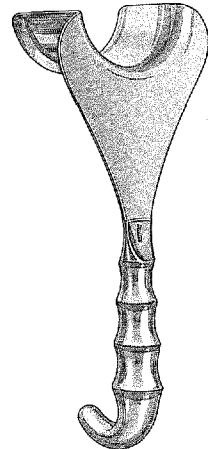

30-340

- 30-300 JACKSON Vaginal Retractor 7" (17.8 cm), Blade 1½" (3.8 cm) x 3" (7.6 cm)
- 30-305 JACKSON Vaginal Retractor 7" (17.8 cm), Blade 1½" (3.8 cm) x 3½" (8.9 cm)
- 30-310 JACKSON Vaginal Retractor 7" (17.8 cm), Blade 1½" (3.8 cm) x 4" (10.2 cm)
- 30-320 EASTMAN Vaginal Retractor 7" (17.8 cm), Blade 1½" (3.8 cm) x 3" (7.6 cm)
- 30-325 EASTMAN Vaginal Retractor 7" (17.8 cm), Blade 1½" (3.8 cm) x 3½" (8.9 cm)
- 30-330 EASTMAN Vaginal Retractor 7" (17.8 cm), Blade 1½" (3.8 cm) x 4" (10.2 cm)
- 30-340 DE LEE Universal Retractor 9½" (24.1 cm), Blade 2¾" (7 cm) x 2" (5.1 cm)
- 30-395 DOYEN Vaginal Retractor 9" (22.9 cm), Blade 1¾" (4.4 cm) x 2½" (6.4 cm)
- 30-406 DOYEN Vaginal Retractor 9" (22.9 cm), Blade 2⅞" (5.4 cm) x 3" (7.6 cm)
- 30-415 DOYEN Vaginal Retractor 9" (22.9 cm), Blade 2¼" (5.7 cm) x 3½" (8.9 cm)

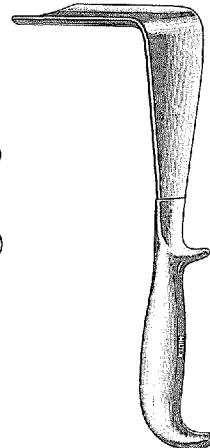

30-395 to 30-415

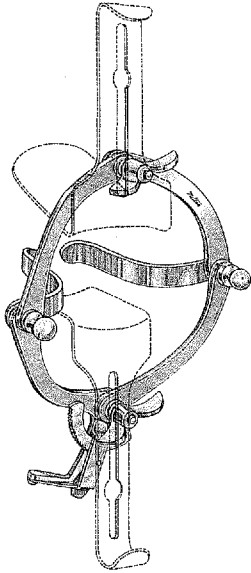

30-370



11-180 to 11-184

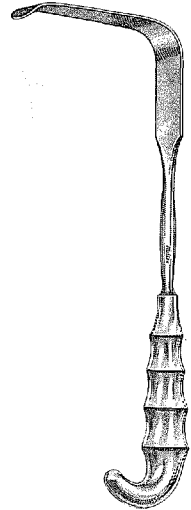

11-185

- 30-370** O'SULLIVAN-O'CONNOR Self-Retaining Vaginal Retractor, complete with 3 interchangeable blades $\frac{1}{2}$ " (1.3 cm) x $1\frac{1}{8}$ " (4.7 cm), $1\frac{1}{2}$ " (3.8 cm) x $3\frac{1}{2}$ " (8.9 cm) and $1\frac{3}{4}$ " (4.4 cm) x $3\frac{1}{2}$ " (8.9 cm)
- 11-180** HEANEY Hysterectomy Retractor $10\frac{1}{2}$ " (26.7 cm), Blade 1" (2.5 cm) x $1\frac{3}{4}$ " (4.4 cm)
- 11-182** HEANEY Hysterectomy Retractor $10\frac{1}{2}$ " (26.7 cm), Blade $1\frac{1}{8}$ " (2.8 cm) x $2\frac{1}{8}$ " (7.3 cm)
- 11-184** HEANEY Hysterectomy Retractor $10\frac{1}{2}$ " (26.7 cm), Blade $1\frac{1}{8}$ " (2.8 cm) x $3\frac{1}{4}$ " (8.3 cm)
- 11-185** HEANEY-SIMON Vaginal Retractor $11\frac{1}{2}$ " (29.2 cm), Blade 1" (2.5 cm) x $4\frac{1}{2}$ " (11.4 cm)



Gynecological and Obstetrical Instruments

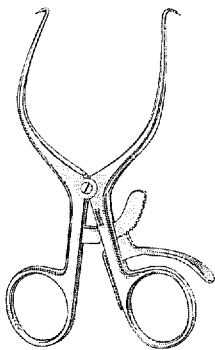

11-365
11-366

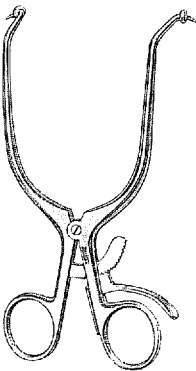

11-368

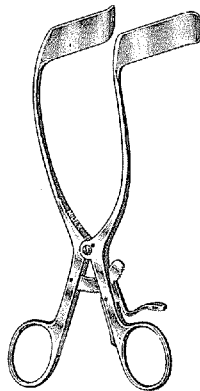

11-374

- 11-365 Pediatric GELPI Perineal Retractor 5½" (14 cm), with grip-lock
- 11-366 GELPI Perineal Retractor 6¾" (17.1 cm), with grip-lock
- 11-368 GELPI Perineal Retractor 6¾" (17.1 cm), with ball stops and grip-lock
- 11-374 RIGBY Vaginal Retractor 6¾" (17.1 cm), with grip-lock

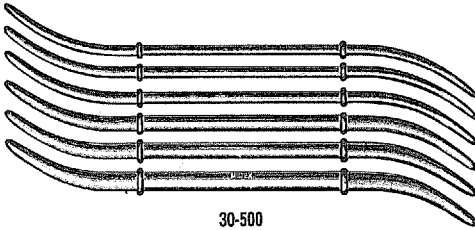

30-500
30-505



30-515 to 30-530

HANK UTERINE DILATORS 11" (27.9 CM), DOUBLE END

30-500	Set of 6 Dilators in Khaki Roll, Sizes 11-12, (3.6-4 mm), 13-14 (4.3-4.6 mm), 15-16 (5-5.3 mm), 17-18 (5.6-6 mm), 19-20 (6.3-6.6 mm), and 21-22 (7-7.3 mm) French		
30-505-78	7-8 Fr. (2.3-2.6 mm)	30-505-1516	15-16 Fr. (5-5.3 mm)
30-505-910	9-10 Fr. (3-3.3 mm)	30-505-1718	17-18 Fr. (5.6-6 mm)
30-505-1112	11-12 Fr. (3.6-4 mm)	30-505-1920	19-20 Fr. (6.3-6.6 mm)
30-505-1314	13-14 Fr. (4.3-4.6 mm)	30-505-2122	21-22 Fr. (7-7.3 mm)
		30-505-2324	23-24 Fr. (7.6-8 mm)
		30-505-2526	25-26 Fr. (8.3-8.6 mm)
		30-505-2728	27-28 Fr. (8.9-9.2 mm)
		30-505-2930	29-30 Fr. (9.6-10 mm)

HEGAR UTERINE DILATORS 7" (17.8 cm), SINGLE END

30-515	Set of 14 Dilators in Khaki Roll, Sizes 4 to 17 mm		
30-520	Set of 26 Dilators in Khaki Roll, Sizes 1 to 26 mm		
30-530-1	1 mm	30-530-85	8.5 mm
30-530-15	1.5 mm	30-530-9	9 mm
30-530-2	2 mm	30-530-95	9.5 mm
30-530-25	2.5 mm	30-530-10	10 mm
30-530-3	3 mm	30-530-105	10.5 mm
30-530-35	3.5 mm	30-530-11	11 mm
30-530-4	4 mm	30-530-115	11.5 mm
30-530-45	4.5 mm	30-530-12	12 mm
30-530-5	5 mm	30-530-125	12.5 mm
30-530-55	5.5 mm	30-530-13	13 mm
30-530-6	6 mm	30-530-135	13.5 mm
30-530-65	6.5 mm	30-530-14	14 mm
30-530-7	7 mm	30-530-145	14.5 mm
30-530-75	7.5 mm	30-530-150	15 mm
30-530-8	8 mm	30-530-155	15.5 mm
		30-530-16	16 mm
		30-530-165	16.5 mm
		30-530-17	17 mm
		30-530-175	17.5 mm
		30-530-18	18 mm
		30-530-185	18.5 mm
		30-530-19	19 mm
		30-530-20	20 mm
		30-530-21	21 mm
		30-530-22	22 mm
		30-530-23	23 mm
		30-530-24	24 mm
		30-530-250	25 mm
		30-530-26	26 mm



Gynecological and Obstetrical Instruments

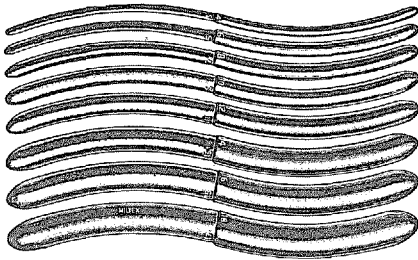

30-550
30-555

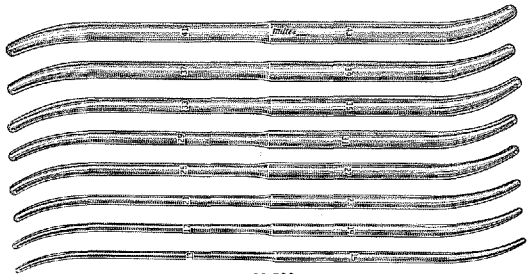

30-560
30-561

HEGAR UTERINE DILATORS 7½" (19.1 cm), DOUBLE END

30-550 Set of 8 Dilators in Khaki Roll, sizes 3-5 mm to 17-18 mm

30-555-34	3-4 mm	30-555-1112	11-12 mm
30-555-56	5-6 mm	30-555-1314	13-14 mm
30-555-78	7-8 mm	30-555-1516	15-16 mm
30-555-910	9-10 mm	30-555-1718	17-18 mm

PRATT UTERINE DILATORS 11½" (29.2 cm), DOUBLE END

30-561 Set of 8 Dilators in Khaki Roll, sizes 13-15 Fr. (4.3-5 mm) to 41-43 Fr. (13.5-14.2 mm)

30-560-1315	13-15 Fr. (4.3-4.6 mm)	30-560-2931	29-31 Fr. (9.6-10.2 mm)
30-560-1719	17-19 Fr. (5.6-6.3 mm)	30-560-3335	33-35 Fr. (10.9-11.6 mm)
30-560-2123	21-23 Fr. (7-7.6 mm)	30-560-3739	37-39 Fr. (12.2-12.9 mm)
30-560-2527	25-27 Fr. (8.3-9 mm)	30-560-4143	41-43 Fr. (13.5-14.2 mm)

Gynecological and Obstetrical Instruments

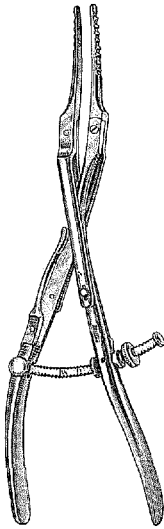

30-620
30-625

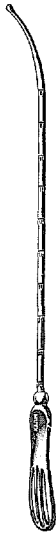

30-650



30-655

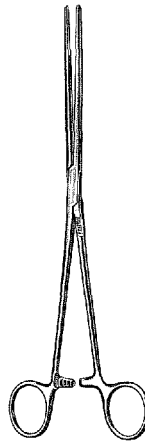

7-620

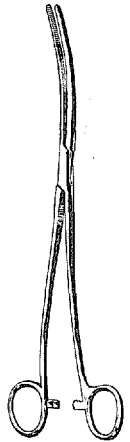

7-622

- 30-620 GOODELL Uterine Dilator 13" (33 cm), Large Model, with gauge and corrugated blades
- 30-625 GOODELL Uterine Dilator 11" (27.9 cm), Small Model, with gauge and corrugated blades
- 30-650 SIMS Uterine Sound 13" (33 cm), graduated in cm, malleable, silver plated
- 30-655 SIMPSON Uterine Sound 13" (33 cm), graduated in inches, malleable, silver plated
- 7-620 BOZEMAN Uterine Dressing Forceps 10½" (26.7 cm), straight
- 7-622 BOZEMAN Uterine Dressing Forceps 10½" (26.7 cm), double curved, standard model
- 7-624 BOZEMAN Uterine Dressing Forceps 10½" (26.7 cm), double curved, with one large finger ring
- 30-835 CHERON Uterine Dressing Forceps 10½" (26.7 cm), rings angled sideways, serrated jaws 8 x 25 mm

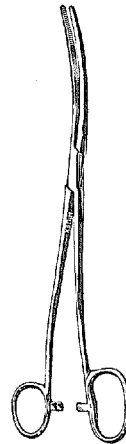

7-624

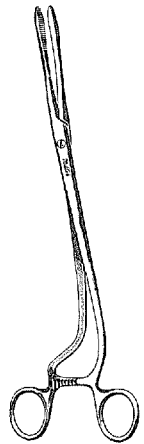

30-835



Gynecological and Obstetrical Instruments

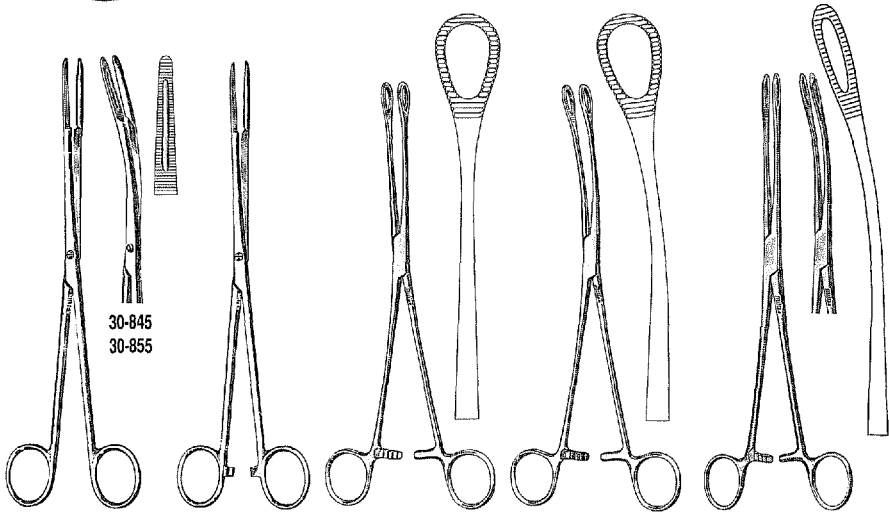

30-840

30-850

7-600
7-602

7-610
7-612

7-630 to 7-632

30-845
30-855

MAIER UTERINE DRESSING FORCEPS 10" (25.4 cm)

Serrated Jaws 5 x 30 mm

Without Ratchet

30-840

30-845

Straight

Curved

With Ratchet

30-850

30-855

- 7-600 FOERSTER Sponge Forceps 9½" (24.1 cm), straight, serrated jaws
- 7-602 FOERSTER Sponge Forceps 9½" (24.1 cm), straight, smooth jaws
- 7-610 FOERSTER Sponge Forceps 9½" (24.1 cm), curved, serrated jaws
- 7-612 FOERSTER Sponge Forceps 9½" (24.1 cm), curved, smooth jaws
- 7-630 FLETCHER Cervix Holding Forceps 9½" (24.1 cm), straight, serrated jaws
- 7-632 FLETCHER Cervix Holding Forceps 9½" (24.1 cm), curved, serrated jaws
(This instrument can also be used as a polyp forceps.)
- V930-996 VANTAGE Polyp Forceps 10½" (26.7 cm), angled shanks, delicate narrow jaws

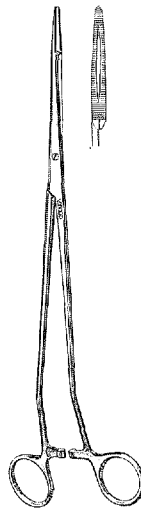

V930-996

Gynecological and Obstetrical Instruments



30-940



30-950

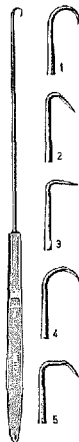

30-951 to 30-955

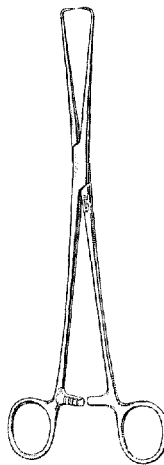

30-965

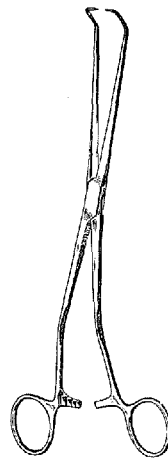

30-970

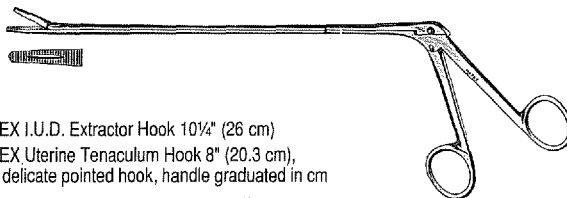

29-102

- 30-940 MILTEX I.U.D. Extractor Hook 10¼" (26 cm)
 30-950 MILTEX Uterine Tenaculum Hook 8" (20.3 cm),
 extra delicate pointed hook, handle graduated in cm

EMMETT UTERINE TENACULUM HOOKS
 9" (22.9 cm), Sharp Points

- | | | | |
|--------|----------------------------|--------|----------------------------|
| 30-951 | Style 1 Half-Curved, small | 30-954 | Style 4 Half-Curved, large |
| 30-952 | Style 2 Acute Angle | 30-955 | Style 5 Double Angle |
| 30-953 | Style 3 Right Angle | | |

30-965 SCHROEDER-BRAUN Uterine Tenaculum Forceps 9¾" (24.8 cm), straight

30-970 KAHN Uterine Tenaculum Forceps 9½" (24.1 cm), angled jaws and bent shanks

29-102 MATHIEU I.U.D. Removal Forceps 11½" (29.2 cm) shaft, serrated jaws
 3.5 mm x 17 mm

30-975 DUPLAY Uterine Tenaculum Forceps 11" (27.9 cm), double curved

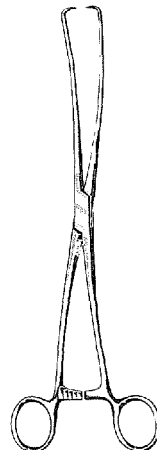

30-975



Gynecological and Obstetrical Instruments

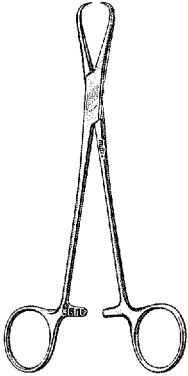

16-51

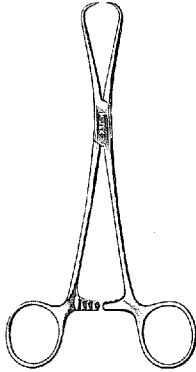

28-200

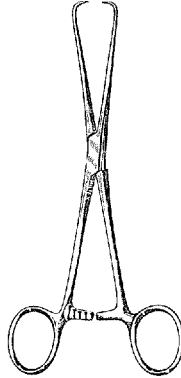

30-985

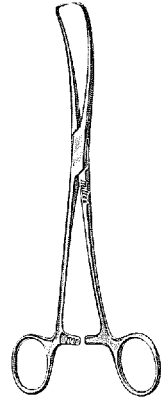

30-988

- 16-51 ADAIR Breast or Uterine Tenaculum Forceps
6½" (16.5 cm), straight
- 28-200 STAUDE-MOORE (FERGUSON) Tenaculum Forceps
6¾" (17.1 cm), straight
- 30-985 BARRETT Uterine Tenaculum Forceps 7¼" (18.4 cm), straight
- 30-988 JARCHO Uterine Tenaculum Forceps 8" (20.3 cm),
double curved
- 30-990 SKENE Uterine Tenaculum Forceps 9½" (24.1 cm),
curved on side
- V930-856 VANTAGE Atraumatic Tenaculum Forceps 9" (22.9 cm),
straight, ¼" (.64 cm) jaws

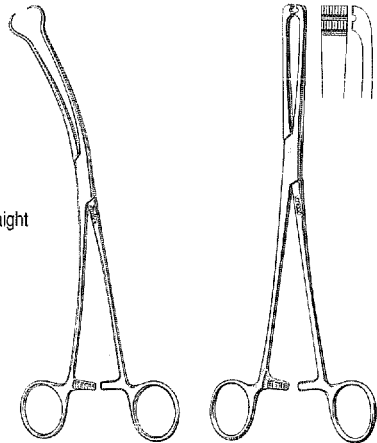

30-990

V930-856

Gynecological and Obstetrical Instruments

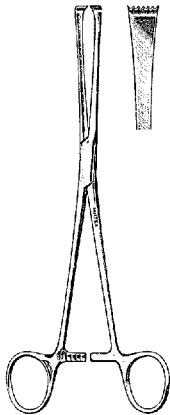

16-38

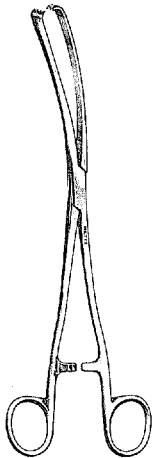

30-997

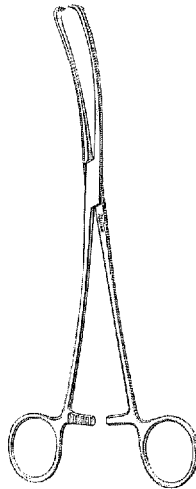

30-998

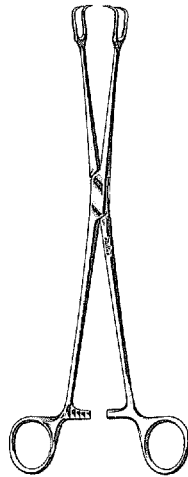

30-1000

16-38 THOMS-ALLIS Vulsellum Forceps 8" (20.3 cm),
6 x 7 teeth

30-997 TEALE Vulsellum Forceps 10" (25.4 cm),
curved sideways, 3 x 4 teeth, 5 mm wide

30-998 KELLY Vulsellum Forceps 9¼" (23.5 cm),
curved sideways, 4 x 5 teeth, 7.7 mm wide

30-1000 SCHROEDER Uterine Vulsellum Forceps
10" (25.4 cm), straight

30-1005 SCHROEDER Uterine Vulsellum Forceps
10" (25.4 cm), curved on flat

30-1010 SCHROEDER Uterine Vulsellum Forceps
10" (25.4 cm), curved sideways

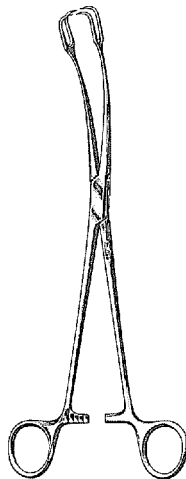

30-1005

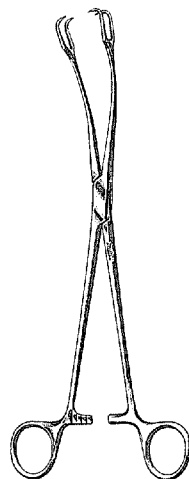

30-1010

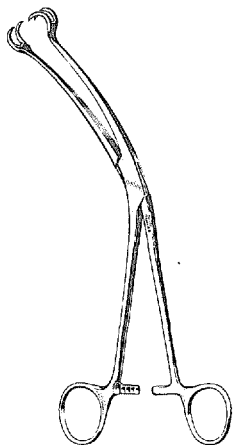

30-1020

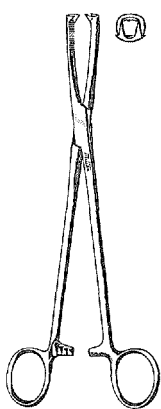

30-1025



30-1030

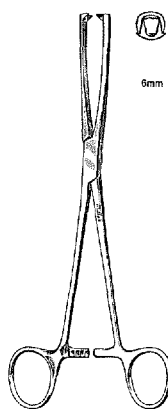

30-1050

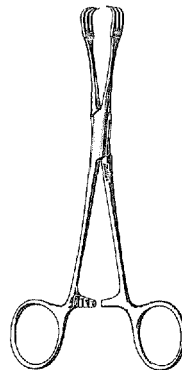

12-80

- 30-1020 SKENE Uterine Vulsellum Forceps 9½" (24.1 cm), curved sideways
- 30-1025 JACOBS Uterine Vulsellum Forceps 8½" (21.6 cm), straight, serrated jaws 2 x 2 teeth
- 30-1030 JACOBS Uterine Vulsellum Forceps 8½" (21.6 cm), curved sideways, serrated jaws 2 x 2 teeth

MUSEUX UTERINE VULSELLUM FORCEPS
9½" (24.1 cm), 2 x 2 teeth

Straight	Jaw Width
30-1050-6	6 mm
30-1050-8	8 mm
30-1050-10	10 mm

- 12-80 M.G.H. (Lahey) Forceps 6¼" (15.9 cm), 3 x 3 teeth, straight
- 30-1077 GORDON Uterine Vulsellum Forceps 9" (22.9 cm), straight, heavy pattern, 3 x 3 teeth

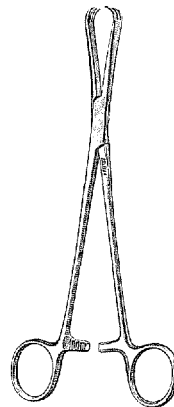

30-1077



6-128

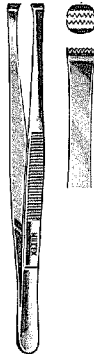

6-134
6-136



6-204



6-142 to 6-145



6-210

- 6-128 HEANEY Tissue Forceps 5½" (14 cm), broad handles, 2 x 3 teeth and cross serrated tips
- 6-134 MARTIN Tissue Forceps 6" (15.2 cm), 7 x 8 teeth
- 6-136 MARTIN Tissue Forceps 7½" (19.1 cm), 7 x 8 teeth
- 6-204 KELLY Tissue Forceps 9" (22.9 cm), 3 x 4 teeth, slotted serrated handles
- 6-142 RUSSIAN Tissue Forceps 6" (15.2 cm)
- 6-144 RUSSIAN Tissue Forceps 8" (20.3 cm)
- 6-145 RUSSIAN Tissue Forceps 10" (25.4 cm)
- 6-210 MAYO-RUSSIAN Tissue Forceps 9" (22.9 cm), fenestrated jaws, slotted grooved handles



Gynecological and Obstetrical Instruments

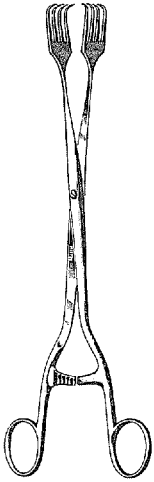

30-1150

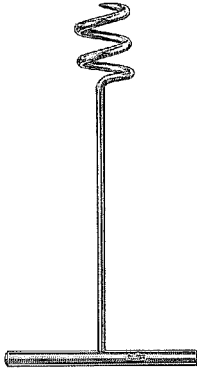

30-1160

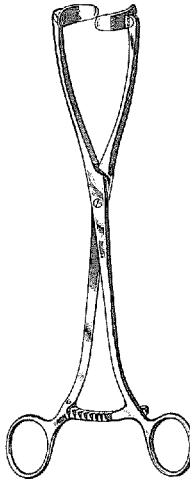

30-1185

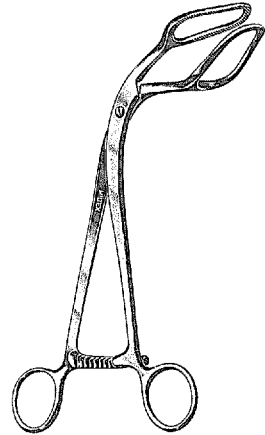

30-1190

- 30-1150 BILLROTH Tumor Forceps 11" (27.9 cm), 4 x 4 prongs
- 30-1160 DOYEN Tumor Screw 6 $\frac{3}{4}$ " (17.1 cm), screw diameter 1" (2.5 cm)
- 30-1185 COLLIN (BUXTON) Uterine Forceps 10 $\frac{1}{2}$ " (26.7 cm), swivel jaws
- 30-1190 SOMER Uterine Elevating Forceps 9" (22.9 cm), curved jaws

Gynecological and Obstetrical Instruments

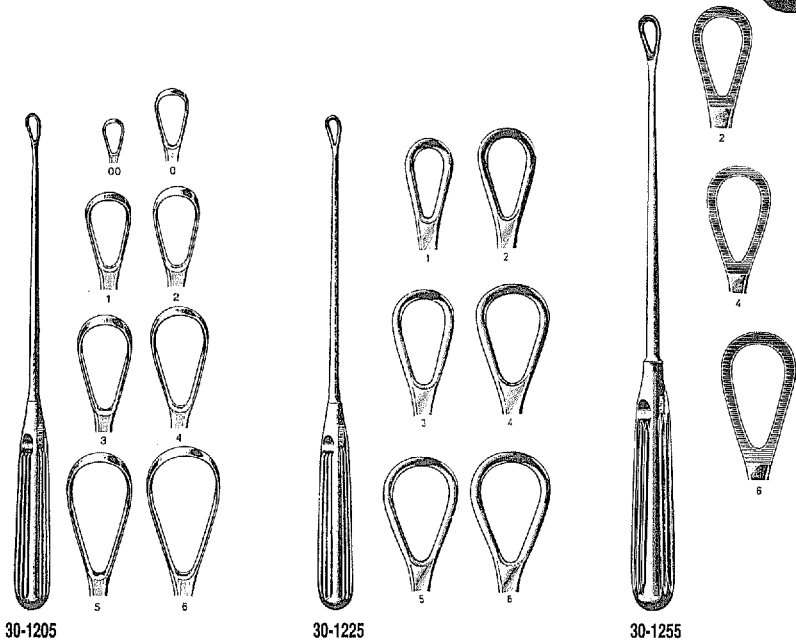

SIMS UTERINE CURETTES 11" (27.9 cm), Sharp Blades on Malleable Shanks

30-1205-00	Size 00	30-1205-3	Size 3
30-1205-0	Size 0	30-1205-4	Size 4
30-1205-1	Size 1	30-1205-5	Size 5
30-1205-2	Size 2	30-1205-6	Size 6

THOMAS UTERINE CURETTES 11" (27.9 cm), Blunt Blades on Malleable Shanks

30-1225-1	Size 1	30-1225-4	Size 4
30-1225-2	Size 2	30-1225-5	Size 5
30-1225-3	Size 3	30-1225-6	Size 6

- 30-1255-2** GREENE Uterine Curette 11" (27.9 cm), Serrated Blunt Blade on Malleable Shank, Size 2
- 30-1255-4** GREENE Uterine Curette 11" (27.9 cm), Serrated Blunt Blade on Malleable Shank, Size 4
- 30-1255-6** GREENE Uterine Curette 11" (27.9 cm), Serrated Blunt Blade on Malleable Shank, Size 6



Gynecological and Obstetrical Instruments

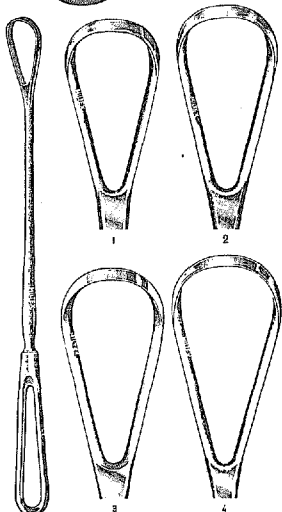

30-1270
30-1275

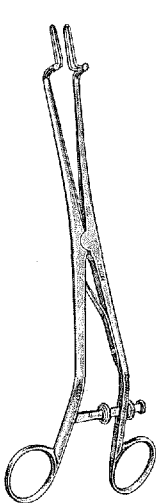

30-1350

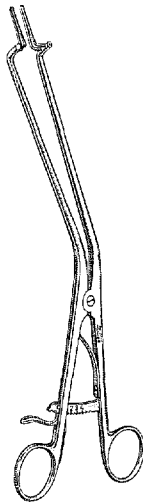

30-1351

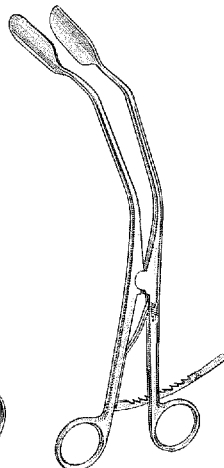

30-1355

BUMM UTERINE CURETTES 12" (30.5 cm), Extra Large Sizes on Malleable Shanks

Sharp	Size	Blunt
30-1270-1	1	30-1275-1
30-1270-2	2	—
30-1270-3	3	—
30-1270-4	4	30-1275-4

- 30-1350** KOGAN Endocervical Speculum 9½" (24.1 cm), with gauge and set screw, offset ring handles, fenestrated jaws 7 x 25 mm
- 30-1351** MILTEX-KOGAN Endocervical Speculum 11" (27.9 cm), improved pattern with ratchet and gauge. Extra delicate fenestrated jaws 3 mm wide at tip x 25 mm long
- 30-1355** Lateral Vaginal Retractor 8¼" (21 cm) with extra long thumb ratchet retracts up to a full 2¼" (5.7 cm) for an extra wide viewing area.

Gynecological and Obstetrical Instruments



30-1380

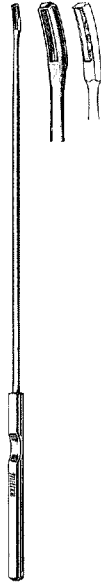

30-1382
30-1383



30-1385

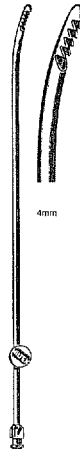

30-1390 to 30-1392

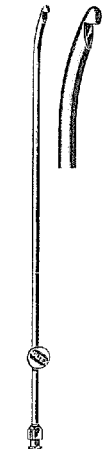

30-1395

- 30-1380 SIMS Uterine Biopsy Curette 10" (25.4 cm), extra small sharp loop, outside meas. 2.5 x 5 mm
- 30-1382 KEVORKIAN-YOUNGE Endocervical Biopsy Curette 12" (30.5 cm), loop size 3 x 12 mm, with basket
- 30-1383 KEVORKIAN-YOUNGE Endocervical Biopsy Curette 12" (30.5 cm), loop size 3 x 12 mm, without basket
- 30-1385 HEANEY Uterine Biopsy Curette 9" (22.9 cm), serrated loop
- 30-1390 NOVAK Endometrial Suction Biopsy Curette 9 $\frac{3}{4}$ " (24.8 cm), with Luer hub, 4 mm dia., standard 12 Fr. size
- 30-1391 NOVAK Endometrial Suction Biopsy Curette 9 $\frac{3}{4}$ " (24.8 cm), with Luer hub, 2 mm dia., extra delicate
- 30-1392 NOVAK Endometrial Suction Biopsy Curette 9 $\frac{3}{4}$ " (24.8 cm), with Luer hub, 3 mm dia., delicate
- 30-1395 RANDALL Endometrial Suction Biopsy Curette 9 $\frac{3}{4}$ " (24.8 cm), with Luer hub, 4 mm dia.

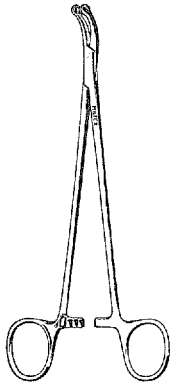

30-1400

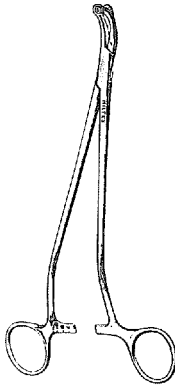

30-1405
30-1410

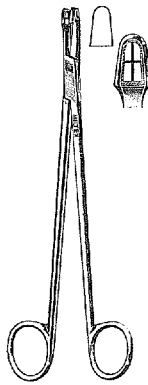

30-1420

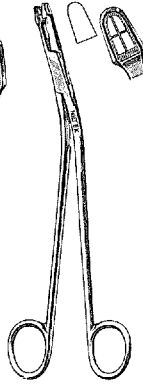

30-1425

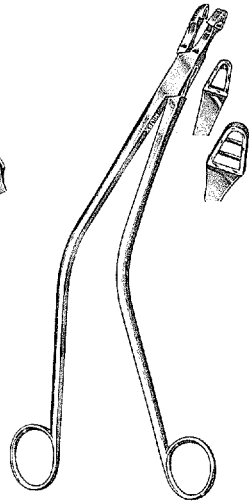

30-1430

- 30-1400 GAYLOR Uterine Biopsy Forceps 8½" (21.6 cm), straight shanks, curved jaws, 5 mm bite, interfitted cups
- 30-1405 THOMS-GAYLOR Uterine Biopsy Forceps 8½" (21.6 cm), angled shanks, curved jaws, 5 mm bite, interfitted cups
- 30-1410 THOMS-GAYLOR Uterine Biopsy Forceps 9½" (24.1 cm), angled shanks, curved jaws, 5 mm bite, interfitted cups
- 30-1420 SCHUBERT Uterine Biopsy Forceps 8½" (21.6 cm), straight
- 30-1425 SCHUBERT Uterine Biopsy Forceps 8½" (21.6 cm), curved
- 30-1430 SCHUBERT Uterine Biopsy Forceps 11" (27.9 cm), angled shanks
- 30-1435 SCHUBERT Uterine Biopsy Forceps 11" (27.9 cm), S-shape, triangular bite
- 30-1440 GELLHORN Uterine Biopsy Forceps 9½" (24.1 cm), curved, oval bite, 5 x 8 mm

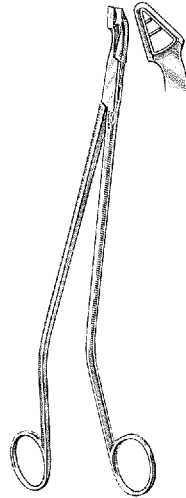

30-1435

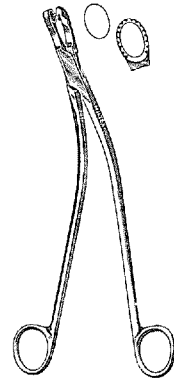

30-1440

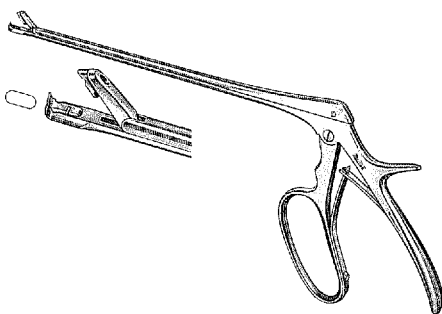

30-1442

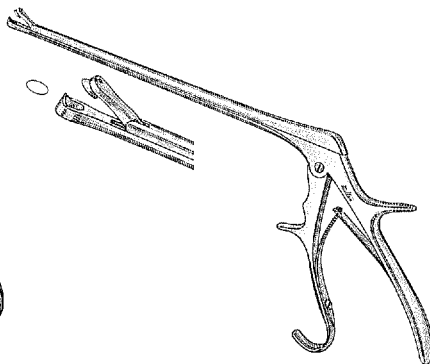

30-1443

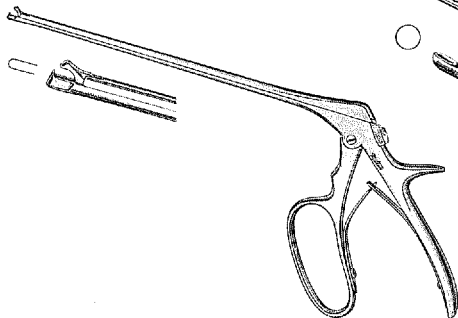

30-1445

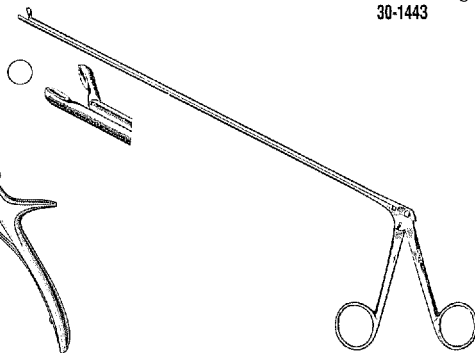

30-1480

- 30-1442 TISCHLER Cervical Biopsy Punch Forceps 9¾" (24.8 cm) shaft, 6 x 3 x 1.5 mm bite
- 30-1443 BURKE (Modified Baby TISCHLER) Cervical Biopsy Punch Forceps 7¾" (19.7 cm) shaft, 4.5 x 3 x 1.5 mm bite
- 30-1445 TOWNSEND 'Mini-bite' Cervical Biopsy Punch Forceps 7½" (19.1 cm) shaft, 4.2 x 2.3 x 1 mm bite with locking mechanism
- 30-1480 MILTEX Cup Jaw Uterine Biopsy Forceps 9" (22.9 cm) shaft, plain not interfitted cups, 6 mm bite



Gynecological and Obstetrical Instruments

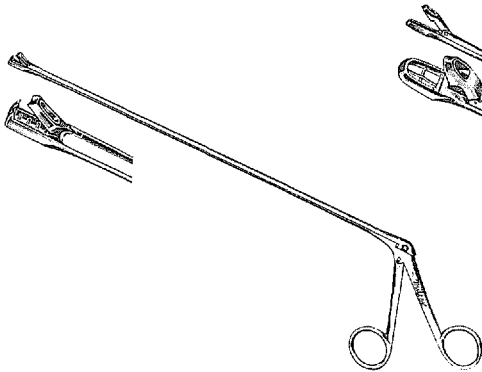

30-1482

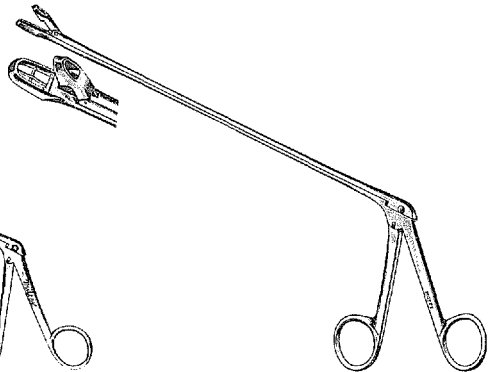

30-1485

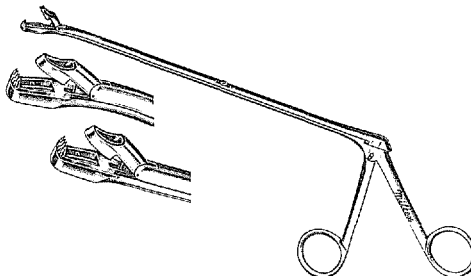

30-1486
30-1487

- 30-1482 KEVORKIAN-YOUNGE Uterine Biopsy Forceps
9½" (24.1 cm) shaft, 3.5 x 8 mm bite, teeth on lower jaw
- 30-1485 EPPENDORFER Uterine Biopsy Forceps, 8½" (21.6 cm) shaft
- 30-1486 WITTNER Uterine Biopsy Forceps 8½" (21.6 cm) shaft, with teeth
on lower jaw, standard model with angled tip
- 30-1487 WITTNER Uterine Biopsy Forceps 8½" (21.6 cm) shaft, with teeth
on lower jaw, straight tip

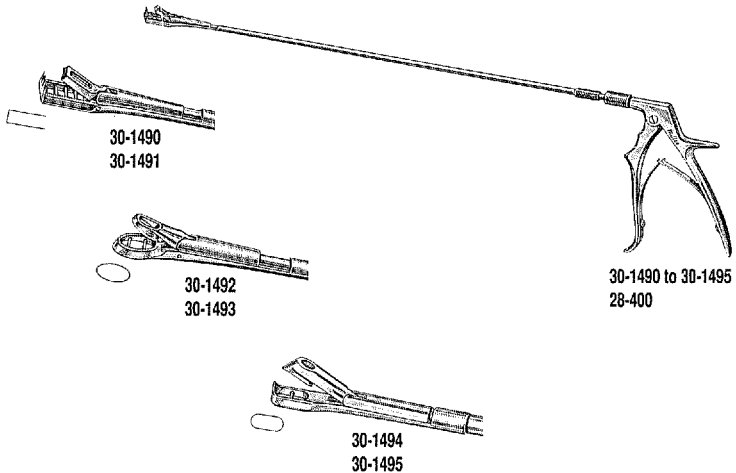

MILTEX ROTATING SHAFT UTERINE BIOPSY FORCEPS
 9" (22.9 cm) shafts are interchangeable on Pistol Grip Spring Handles

- 30-1490** KEVORKIAN-YOUNGE Biopsy Forceps, 3.5 x 8 mm bite, teeth on lower jaw, complete with Pistol Grip Handle
- 30-1491** KEVORKIAN-YOUNGE Biopsy Forceps, Shaft only
- 30-1492** EPPENDORFER-KRAUSE Biopsy Forceps, oval 4.5 x 6.5 mm bite, complete with Pistol Grip Handle
- 30-1493** EPPENDORFER-KRAUSE Biopsy Forceps, Shaft only
- 30-1494** TISCHLER Biopsy Forceps, 3 x 7 mm bite, complete with Pistol Grip Handle
- 30-1495** TISCHLER Biopsy Forceps, Shaft only
- 28-400** Pistol Grip Spring Handle fitting all Miltex Rotating Shaft Uterine Biopsy Forceps (this handle also fits Rectal Biopsy Punches Nos. 28-380 to 28-416)



Gynecological and Obstetrical Instruments

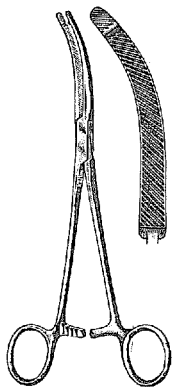

30-1700

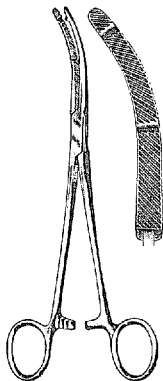

30-1710
30-1715

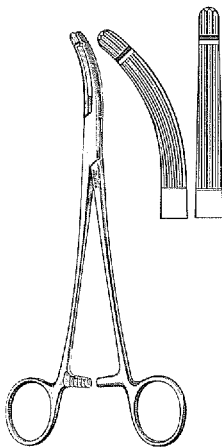

30-1716
30-1718

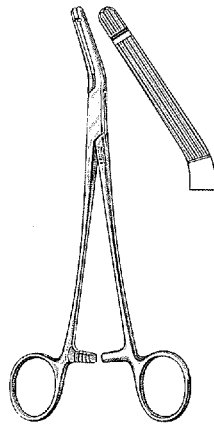

30-1720

- 30-1700 HEANEY Hysterectomy Forceps 8¼" (21 cm), heavy pattern, single tooth, curved
- 30-1710 HEANEY Hysterectomy Forceps 8¼" (21 cm), heavy pattern, double tooth, curved
- 30-1715 HEANEY Hysterectomy Forceps 9¾" (24.8 cm), extra heavy pattern, double tooth, curved
- 30-1716 HEANEY-BALLENTINE Hysterectomy Forceps 8½" (21 cm), longitudinal serrations, single tooth, curved
- 30-1718 BALLENTINE Hysterectomy Forceps 8½" (21.6 cm), longitudinal serrations, single tooth, straight
- 30-1720 GARLAND Hysterectomy Forceps 8½" (21 cm), longitudinal serrations, single tooth, angled on flat

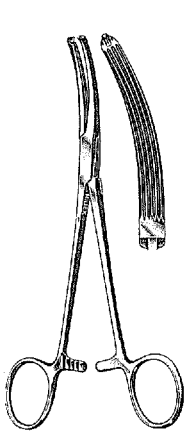

30-1730

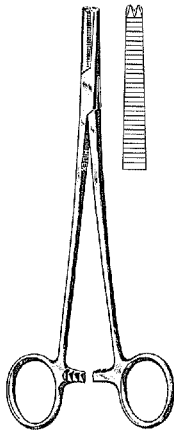

30-1735

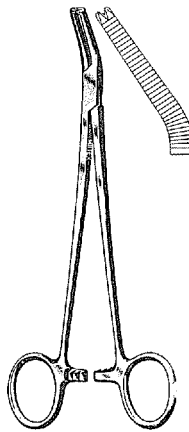

30-1740

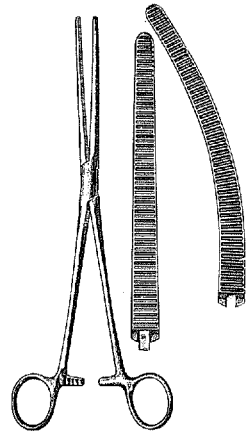

7-124 to 7-148

- 30-1730 LONG Hysterectomy Forceps 7½" (19.1 cm), longitudinal serrations, 1 x 2 teeth, curved
- 30-1735 PHANEUF Uterine Artery Forceps 8" (20.3 cm), horizontal serrated jaws, 1 x 2 teeth, straight
- 30-1740 PHANEUF Uterine Artery Forceps 8" (20.3 cm), horizontal serrated jaws, 1 x 2 teeth, angled on flat

PEAN HYSTERECTOMY FORCEPS, with Horizontal Serrations

Straight	Size	Curved
7-124	8" (20.3 cm)	7-142
7-126	9" (22.9 cm)	7-144
7-128	10¼" (26 cm)	7-146
7-130	12" (30.5 cm)	7-148

- 30-1805 PEAN Hysterectomy Forceps 9" (22.9 cm), curved, with longitudinal serrations
- 30-1815 PEAN Hysterectomy Forceps 10¼" (26 cm), curved, with longitudinal serrations

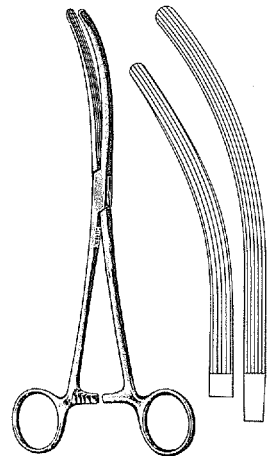

30-1805
30-1815



Gynecological and Obstetrical Instruments

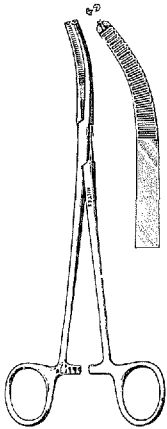

7-190

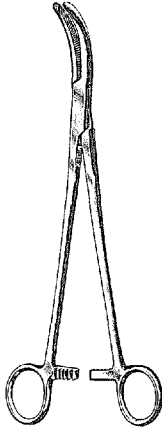

29-280

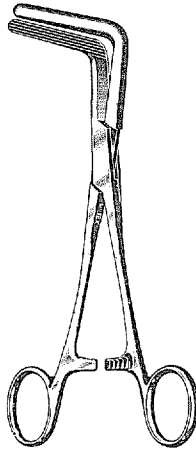

29-282

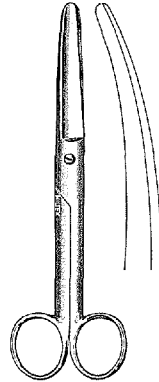

5-160
5-162

- 7-190 MICULICZ Peritoneal Clamp 8" (20.3 cm), curved, 1 x 2 teeth
- 29-280 WERTHEIM Vaginal Forceps 9 $\frac{3}{4}$ " (24.8 cm), curved, 2" (5.1 cm) jaws
- 29-282 WERTHEIM-CULLEN Pedicle Forceps 8 $\frac{1}{2}$ " (21.6 cm), right angle 2" (5.1 cm) jaws
- 5-160 DOYEN Scissors 7" (17.8 cm), straight, heavy pattern
- 5-162 DOYEN Scissors 7" (17.8 cm), curved, heavy pattern
- 5-166 FERGUSON Scissors 7" (17.8 cm), angled on flat

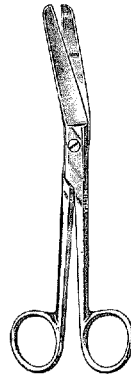

5-166

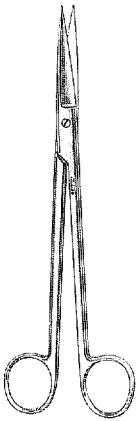

5-220 to 5-224

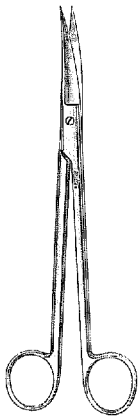

5-226 to 5-230



5-250
5-252

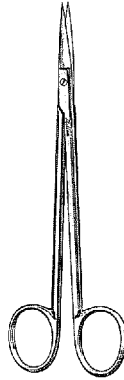

5D-251

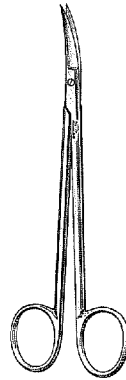

5D-253

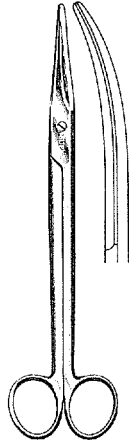

5-128
5-130

SIMS UTERINE SCISSORS 8" (20.3 cm)

Straight	Points	Curved
5-220	Sharp-Sharp	5-226
5-222	Sharp-Blunt	5-228
5-224	Blunt-Blunt	5-230

- 5-250 KELLY Uterine Scissors 6 1/4" (15.9 cm), sharp points, straight
- 5D-251 KELLY Uterine Scissors 6 1/4" (15.9 cm), sharp points, straight, with one serrated blade
- 5-252 KELLY Uterine Scissors 6 1/4" (15.9 cm), sharp points, curved
- 5D-253 KELLY Uterine Scissors 6 1/4" (15.9 cm), sharp points, curved, with one serrated blade
- 5-128 MAYO Uterine Scissors 9" (22.9 cm), straight
- 5-130 MAYO Uterine Scissors 9" (22.9 cm), curved
- 5-186 NELSON Uterine Scissors 9" (22.9 cm), straight
- 5-188 NELSON Uterine Scissors 9" (22.9 cm), curved
- 30-2190 BRAUN Episiotomy Scissors 5 1/2" (14 cm), angled to side, guarded lower blade
- 30-2195 BRAUN Episiotomy Scissors 8 3/4" (21.6 cm), angled to side, guarded lower blade

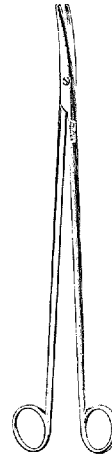

5-186
5-188

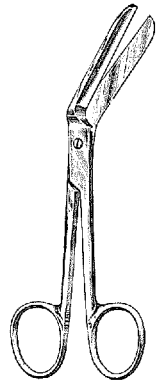

30-2190
30-2195

For Carb-N-Sert Scissors with Tungsten Carbide inserts and Super Cut Scissors – see pages 55-63.

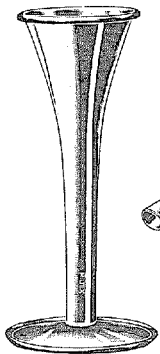

30-2200

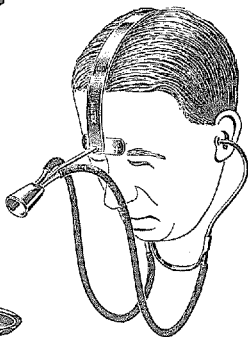

30-2205



30-2210

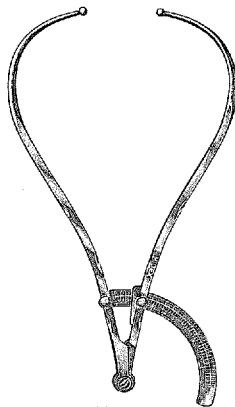

30-2230

- 30-2200 PINARD Fetal Heart Stethoscope, aluminum
- 30-2205 DE LEE-HILLIS Obstetrical Stethoscope with padded head support, rigid metal arm. Complete with binaurals, chrome
- 30-2210 DE LEE Obstetrical Stethoscope, same as No. 30-2205 but with flexible arm, chrome
- 30-2230 MARTIN Pelvimeter, graduated in centimeters and inches
- 30-2235 COLLYER Pelvimeter, graduated in centimeters and inches

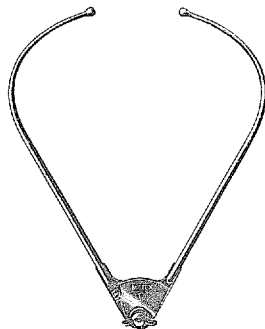

30-2235

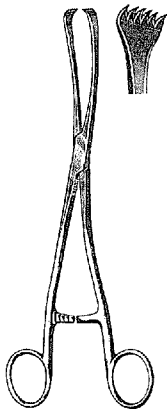

30-2250



30-2260



30-2300



30-2305

30-2250 IOWA Membrane Puncturing Forceps 10¼" (26 cm), double curved, 6 x 6 teeth

30-2260 BEACHAM Amniotome 10¼" (26 cm)

30-2300 SIMPSON Obstetrical Forceps, Long Model, 14" (35.6 cm)

30-2305 SIMPSON Obstetrical Forceps, Short Model, 12" (30.5 cm)



Gynecological and Obstetrical Instruments

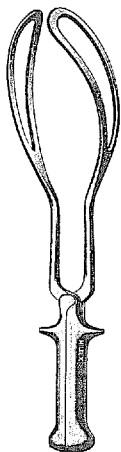

30-2315

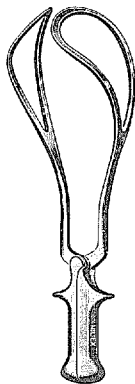

30-2320

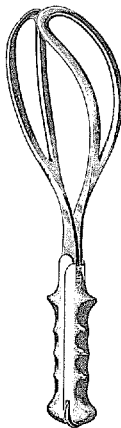

30-2330

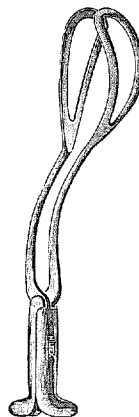

30-2335

- 30-2315 DE LEE Obstetrical Forceps, Standard Model, 14" (35.6 cm)
- 30-2320 DE LEE Obstetrical Forceps, Short Model, 12" (30.5 cm)
- 30-2330 ELLIOTT Obstetrical Forceps, Short Model, 12½" (31.8 cm)
- 30-2335 PIPER Obstetrical Forceps 17½" (44.5 cm)
- 30-2345 BILL Traction Handle, for use with any O.B. Forceps having standard type handle

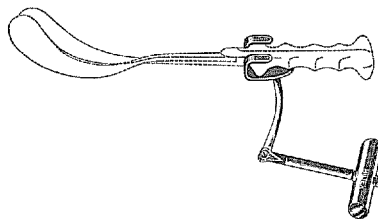

30-2345

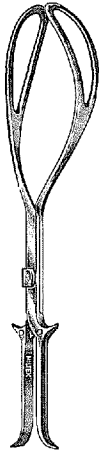

30-2350

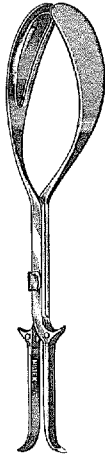

30-2355

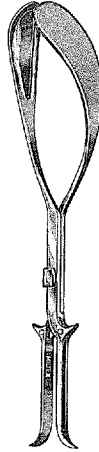

30-2390

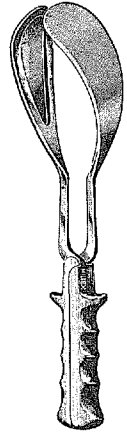

30-2400

- 30-2350 KIELLAND Obstetrical Forceps 15½" (39.4 cm)
- 30-2355 KIELLAND-LUIKART Obstetrical Forceps 15½" (39.4 cm), solid blades
- 30-2390 LUIKART Obstetrical Forceps 15½" (39.4 cm), solid blades
- 30-2400 SIMPSON-LUIKART Obstetrical Forceps 14" (35.6 cm), solid blades



Gynecological and Obstetrical Instruments

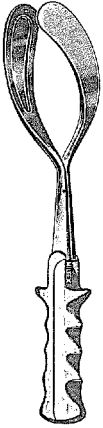

30-2410

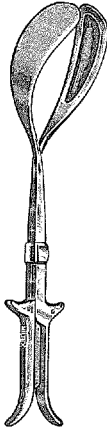

30-2415

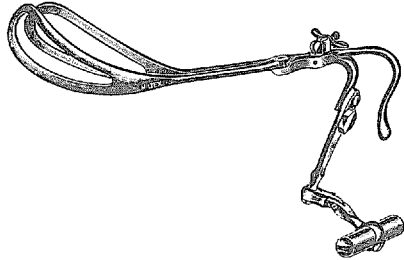

30-2430

30-2410 McLEAN-LUIKART Obstetrical Forceps 15 $\frac{3}{4}$ " (40 cm), solid blades, long shanks

30-2415 McLEAN-TUCKER-LUIKART Obstetrical Forceps 15 $\frac{3}{4}$ " (40 cm), solid blades, long shanks

30-2430 DEWEY Obstetrical Forceps 14" (35.6 cm), with Axis Traction

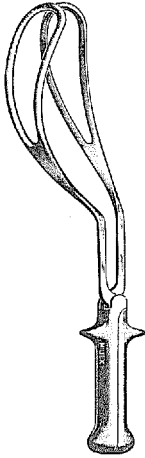

30-2435

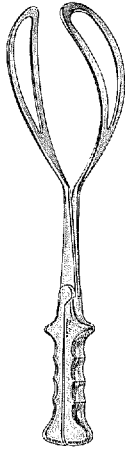

30-2445

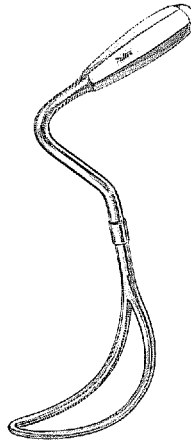

30-2450

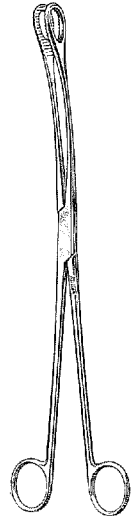

30-2505

- 30-2435 HAWKS-DENNEN Obstetrical Forceps 15" (38.1 cm)
- 30-2445 BAILEY-WILLIAMSON Obstetrical Forceps 15½" (39.4 cm)
- 30-2450 MURLESS Head Extractor 10" (25.4 cm), with hinged shaft and sliding collar lock
- 30-2505 KELLY Placenta Forceps 12½" (31.8 cm), serrated ring jaws, slightly curved



Gynecological and Obstetrical Instruments

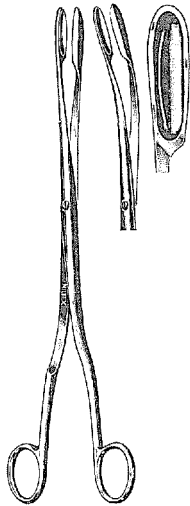

30-2530
30-2535

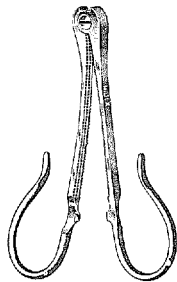

30-2560

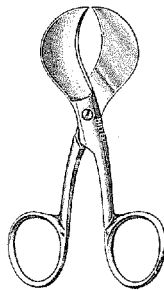

30-2575

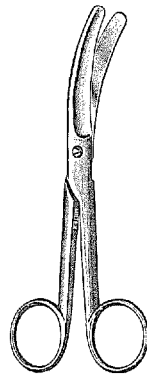

30-2580

- 30-2530 WINTER Placenta Forceps 11" (27.9 cm), cup jaws, straight
- 30-2535 WINTER Placenta Forceps 11" (27.9 cm), cup jaws, curved
- 30-2560 KANE Umbilical Clamp 3½" (8.9 cm)
- 30-2575 Umbilical Scissors 4½" (10.5 cm), American Pattern
- 30-2580 BUSCH Umbilical Scissors 6½" (16.5 cm), curved on side
- 30-2605 DUBOIS Decapitation Scissors 10½" (26.7 cm), curved, extra heavy pattern, blunt points
- 30-2632 IOWA Trumpet Pudendal Needle Guide 5½" (14 cm)

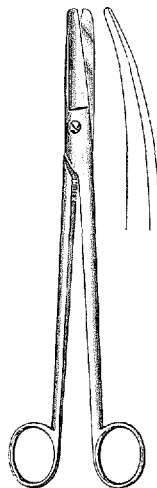

30-2605

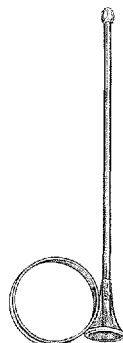

30-2632



33-2 to 33-5B

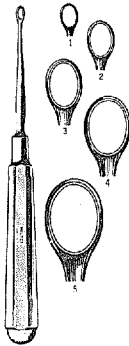

33-6 to 33-11A

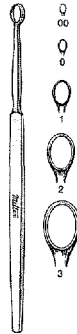

33-16-00 to 33-16-3



33-12 to 33-15



40-54

FOX DERMAL CURETTES 5½" (14 cm), Round

33-2	6 mm dia.	33-5	3 mm dia.
33-3	5 mm dia.	33-5A	2 mm dia.
33-4	4 mm dia.	33-5B	1 mm dia.

PIFFARD DERMAL CURETTES 6¼" (15.9 cm), Oval

33-6	Size 1 (3 mm dia.)	33-11	Size 4 (8 mm dia.)
33-8	Size 2 (5 mm dia.)	33-11A	Size 5 (10 mm dia.)
33-10	Size 3 (6 mm dia.)		

PIFFARD DERMAL CURETTES 5½" (14 cm), oval, narrow handles

33-16-00	Size 00 (1 mm dia.)	33-16-2	Size 2 (5 mm dia.)
33-16-0	Size 0 (1.5 mm dia.)	33-16-3	Size 3 (6 mm dia.)
33-16-1	Size 1 (3 mm dia.)		

33-12	MILTEX Dermal Curette 6¼" (15.9 cm), oval spoon size 0 (3 mm dia.)
33-13	MILTEX Dermal Curette 6¼" (15.9 cm), oval spoon size 1 (4 mm dia.)
33-14	MILTEX Dermal Curette 6¼" (15.9 cm), oval spoon size 2 (5 mm dia.)
33-15	MILTEX Dermal Curette 6¼" (15.9 cm), oval spoon size 3 (6 mm dia.)
40-54	MILTEX Verucca Curette 5" (12.7 cm), cup 4 mm dia.



Dermal Instruments

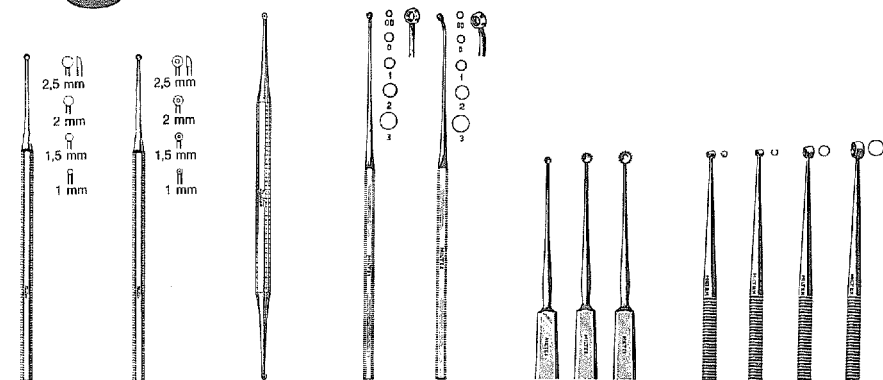

40-57/0
to 40-57/3

40-58/0
to 40-58/3

40-58/1-2
40-58/1-3

19-260 to 19-278

18-520 to 18-524

18-530 to 18-536

MILTEX EXCAVATOR CURETTES, Single End 5" (12.7 cm)

W/O Hole	Diameter	W/Hole
40-57/0	1 mm	40-58/0
40-57/1	1.5 mm	40-58/1
40-57/2	2 mm	40-58/2
40-57/3	2.5 mm	40-58/3

MILTEX EXCAVATOR CURETTES, Double End 5½" (14 cm)

- 40-58/1-2 Small 1.5 mm and Medium 2 mm dia.
- 40-58/1-3 Small 1.5 mm and Large 2.5 mm dia.

BUCK CURETTES 6½" (16.5 cm), Sharp

Straight	Size	Angled
19-260	00	19-270
19-262	0	19-272
19-264	1	19-274
19-266	2	19-276
19-268	3	19-278

- 18-520 SKEELE Curette 5" (12.7 cm), round 1 mm cup, serrated edge
- 18-522 SKEELE Curette 5" (12.7 cm), round 2 mm cup, serrated edge
- 18-524 SKEELE Curette 5" (12.7 cm), round 2.5 mm cup, serrated edge
- 18-530 HEATH Curette 4" (10.2 cm), Size 0, one sharp and one blunt edge, 0.5 mm
- 18-532 HEATH Curette 4" (10.2 cm), Size 1, one sharp and one blunt edge, 1 mm
- 18-534 HEATH Curette 4" (10.2 cm), Size 2, one sharp and one blunt edge, 2 mm
- 18-536 HEATH Curette 4" (10.2 cm), Size 3, one sharp and one blunt edge, 3 mm



33-20 to 33-28

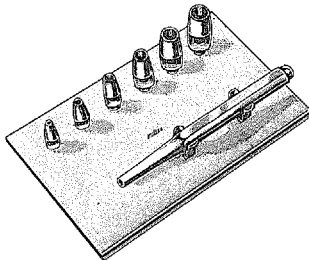

33-30

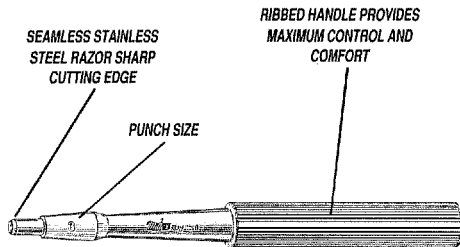

SEAMLESS STAINLESS
STEEL RAZOR SHARP
CUTTING EDGE

RIBBED HANDLE PROVIDES
MAXIMUM CONTROL AND
COMFORT

PUNCH SIZE

33-31A to 33-37

KEYES DERMAL PUNCHES 4" (10.2 cm)

33-20	2 mm	33-25	5 mm
33-22	3 mm	33-26	6 mm
33-24	4 mm	33-28	8 mm

33-30 KEYES Dermal Punch Set, 3½" (8.9 cm) Handle, with screw-in Keyes Knives 2, 3, 4, 5, 6 and 7 mm mounted on storage and sterilization rack

Replacement Parts for No. 33-30 Punch Set

33-30-1	Handle		
33-30-2	2 mm Head	33-30-5	5 mm Head
33-30-3	3 mm Head	33-30-6	6 mm Head
33-30-4	4 mm Head	33-30-7	7 mm Head

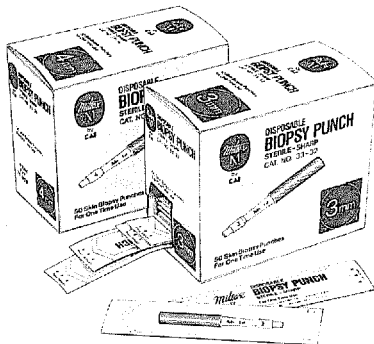

MILTEX Sterile Disposable Bopsy Punches – made by Kai
Each Sterile Bopsy Punch is sealed in a peel-apart see-through package.
Packed 50 Bopsy Punches to a Dispenser Box. Sterilized by EO.

33-31A	1.5 mm	33-34	4 mm
33-31	2 mm	33-35	5 mm
33-32	3 mm	33-36	6 mm
33-33	3.5 mm	33-37	8 mm

FEATURES:

- Seamless stainless steel razor sharp cutting edge
- Ribbed handle provides maximum control and comfort
- Size marked on every punch for easy identification
- Sterile – ready to use every time
- Convenient – use once and discard
- Eliminates need for re-sharpening
- Clean, precise specimens for accurate diagnosis
- Wide range of sizes



33-40

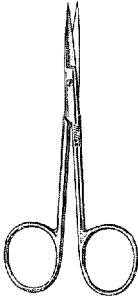

5-300

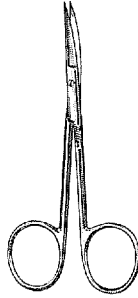

5-302

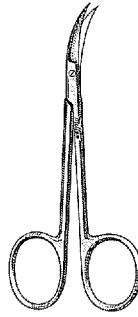

5D-303

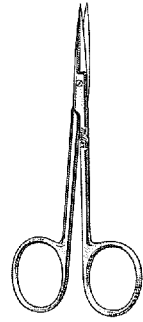

5-304

- 33-40** VAUGHAN Abscess Knife Set 5" (12.7 cm), one straight 20 mm lancet and one curved 12 mm knife, with protective screw-on caps, and pocket clip
- 5-300** Iris Scissors 4" (10.2 cm), straight
- 5-302** Iris Scissors 4" (10.2 cm), curved
- 5D-303** Iris Scissors 4½" (11.4 cm), curved sideways
- 5-304** Iris Scissors 4½" (11.4 cm), straight
- 5-306** Iris Scissors 4½" (11.4 cm), curved
- 5-308** Iris Scissors 4½" (11.4 cm), curved sideways

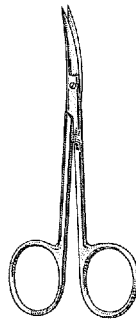

5-306

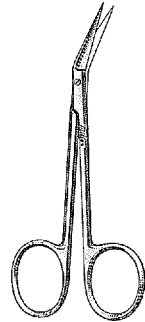

5-308

For Carb-N-Sert Scissors with tungsten carbide inserts and SuperCut Scissors see pages 55 - 63

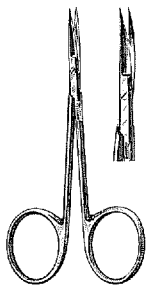

18-1392
18-1394

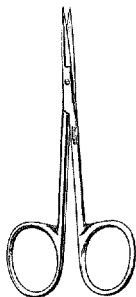

18-1396

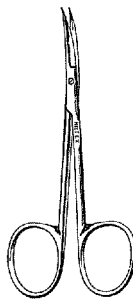

18-1398

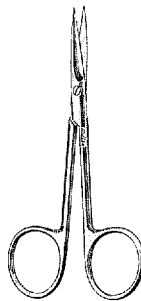

18-1404

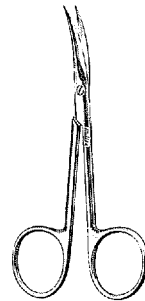

18-1405

- 18-1392 BONN Miniature Iris Scissors 3½" (8.9 cm), with 15 mm blades, straight
- 18-1394 BONN Miniature Iris Scissors 3½" (8.9 cm), with 15 mm blades, curved
- 18-1396 Iris Scissors 3½" (8.9 cm), with 20 mm blades, straight, delicate
- 18-1398 Iris Scissors 3½" (8.9 cm), with 20 mm blades, curved, delicate
- 18-1404 MILTEX Iris Scissors 4" (10.2 cm), straight, heavy pattern
- 18-1405 MILTEX Iris Scissors 4" (10.2 cm), curved, heavy pattern
- 18-1415* Iris Scissors 4" (10.2 cm), straight, standard pattern, ribbon type
- 18-1416* Iris Scissors 4" (10.2 cm), curved, standard pattern, ribbon type
- 18-1417* Iris Scissors 3¾" (9.5 cm), straight, miniature pattern with 14 mm blades, ribbon type
- 18-1418* Iris Scissors 3¾" (9.5 cm), curved, miniature pattern with 14 mm blades, ribbon type

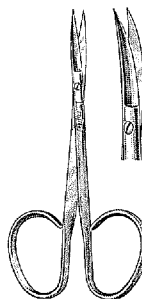

18-1415*
18-1416*

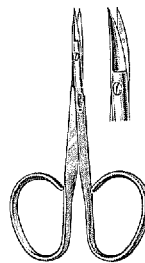

18-1417*
18-1418*

*Ribbon Type Scissors have extra large finger rings; shanks and rings have satin finish; blades are highly polished



Dermal Instruments

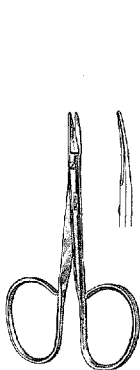

18-1419*

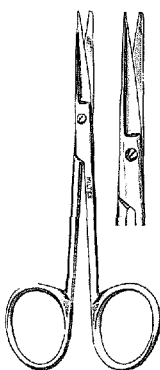

18-1420
18-1422

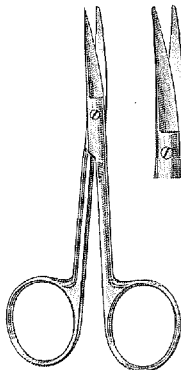

18-1426
18-1428

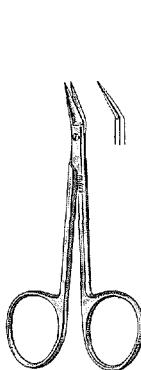

18-1440

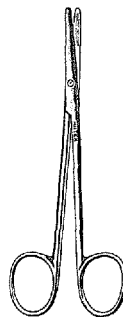

5-312

18-1419* Utility Scissors 3 3/4" (9.5 cm), curved blunt blades, 15 mm long, ribbon type

18-1420 KNAPP Iris Scissors 4" (10.2 cm), straight, sharp-blunt points

18-1422 KNAPP Iris Scissors 4" (10.2 cm), straight, blunt-blunt points

18-1426 KNAPP Iris Scissors 4" (10.2 cm), curved, sharp-blunt points

18-1428 KNAPP Iris Scissors 4" (10.2 cm), curved, blunt-blunt points

18-1440 WILMER Utility Scissors 4" (10.2 cm), angled on flat

5-312 Strabismus Scissors 4" (10.2 cm), straight

5-314 Strabismus Scissors 4" (10.2 cm), curved

18-1453* Strabismus Scissors 4 1/4" (10.8 cm), straight, ribbon type

18-1454* Strabismus Scissors 4 1/4" (10.8 cm), curved, ribbon type

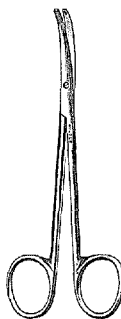

5-314

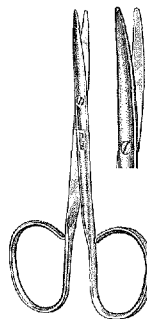

18-1453*
18-1454*

*Ribbon Type Scissors have extra large finger rings; shanks and rings have satin finish; blades are highly polished

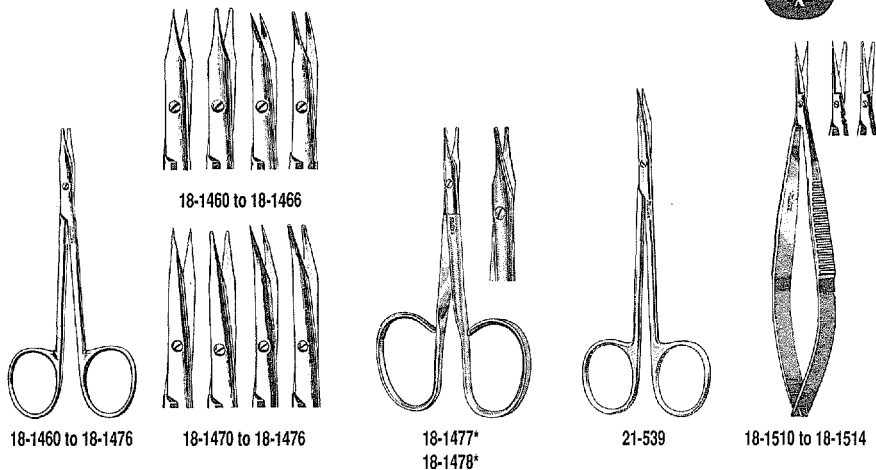

- 18-1460 to 18-1476** **18-1470 to 18-1476** **18-1477***
18-1478*
- 21-539** **18-1510 to 18-1514**
- STEVENS TENOTOMY SCISSORS**
- 18-1460** Straight sharp points 4 $\frac{1}{8}$ " (10.5 cm), short blades
 - 18-1462** Straight blunt points 4 $\frac{1}{8}$ " (10.5 cm), short blades
 - 18-1464** Curved sharp points 4 $\frac{1}{8}$ " (10.5 cm), short blades
 - 18-1466** Curved blunt points 4 $\frac{1}{8}$ " (10.5 cm), short blades
 - 18-1470** Straight sharp points 4 $\frac{1}{2}$ " (11.4 cm), long blades
 - 18-1472** Straight blunt points 4 $\frac{1}{2}$ " (11.4 cm), long blades
 - 18-1474** Curved sharp points 4 $\frac{1}{2}$ " (11.4 cm), long blades
 - 18-1476** Curved blunt points 4 $\frac{1}{2}$ " (11.4 cm), long blades
 - 18-1477*** STEVENS Tenotomy Scissors 3 $\frac{3}{4}$ " (9.5 cm), straight, blunt points, ribbon type
 - 18-1478*** STEVENS Tenotomy Scissors 3 $\frac{3}{4}$ " (9.5 cm), curved, blunt points, ribbon type
- 21-539** KLEINERT-KUTZ Tenotomy Scissors 4 $\frac{7}{8}$ " (12.4 cm), curved, rounded dissecting blades
- 18-1510** NOYES Iris Scissors 4 $\frac{1}{2}$ " (11.4 cm), straight, sharp-sharp points
 - 18-1512** NOYES Iris Scissors 4 $\frac{1}{2}$ " (11.4 cm), straight, sharp-blunt points
 - 18-1514** NOYES Iris Scissors 4 $\frac{1}{2}$ " (11.4 cm), straight, blunt-blunt points
 - 18-1516** NOYES Iris Scissors 4 $\frac{1}{2}$ " (11.4 cm), curved, sharp-sharp points
 - 18-1480** WESTCOTT Eye Scissors 4 $\frac{1}{2}$ " (11.4 cm), curved, blunt points
 - 18-1486** WESTCOTT Eye Scissors 4 $\frac{1}{2}$ " (11.4 cm), curved, sharp points

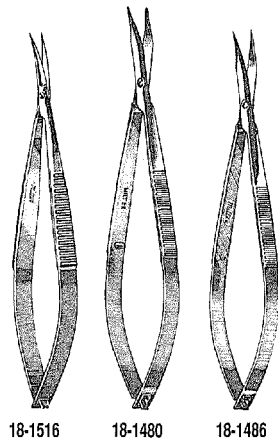

*Ribbon Type Scissors have extra large finger rings; shanks and rings have satin finish; blades are highly polished

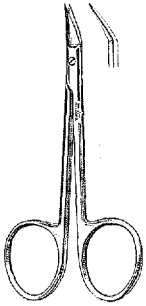

33-240

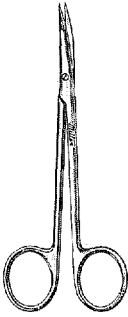

33-242

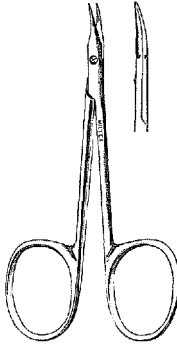

18-1652

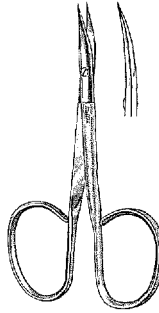

18-1653*

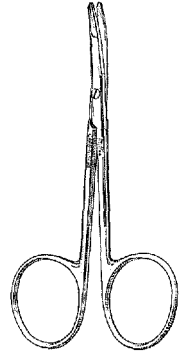

21-537TC

33-240 BIRO Dermal Naevus Scissors 4" (10.2 cm), angled on flat, w/sharp outside edges

33-242 MILTEX Undermining Scissors 4½" (11.4 cm), curved blades, with flat pointed tip

18-1652 GRADLE Scissors 3¾" (9.5 cm), slightly curved, sharp points

18-1653* GRADLE Scissors 4" (10.2 cm), ribbon type, slightly curved, sharp points

21-537TC MILTEX Blepharoplasty Scissors 4½" (11.4 cm), curved flat tips, one serrated and one Carb-N-Sert blade

21-630 JOSEPH Scissors 5¾" (14.6 cm), straight, sharp points

21-632 JOSEPH Scissors 5¾" (14.6 cm), curved, sharp points



21-630

21-632

*Ribbon Type Scissors have extra large finger rings; shanks and rings have satin finish; blades are highly polished

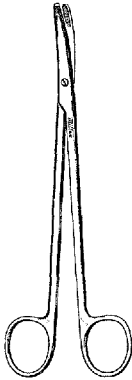

5-180

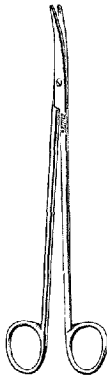

5-284



5-290

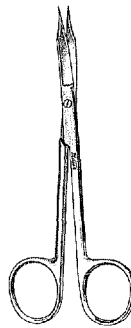

5-320

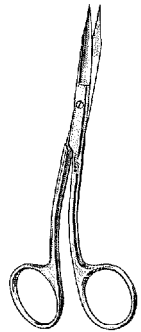

5D-322

- 5-180 METZENBAUM Scissors 5½" (14 cm), curved, standard
- 5-284 METZENBAUM Scissors 5" (12.7 cm), curved, delicate
- 5-290 RAGNELL Undermining Scissors 5" (12.7 cm), curved with flattened dissecting tips
- 5-320 GOLDMAN-FOX Wound Debridement Scissors 5" (12.7 cm), curved fine tips with one serrated blade
- 5D-322 GOLDMAN-FOX Wound Debridement Scissors 5" (12.7 cm), curved, one serrated blade, angled shanks
- 5D-324 LA GRANGE Scissors 4¼" (10.8 cm), curved, one serrated blade, angled shanks

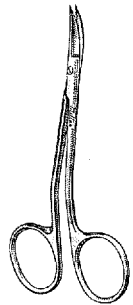

5D-324

For Carb-N-Sert Scissors with tungsten carbide inserts
and SuperCut Scissors see pages 55 - 63

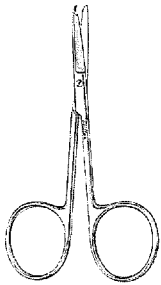

9-100

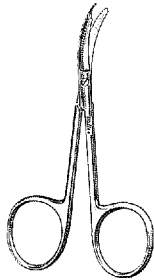

9-101

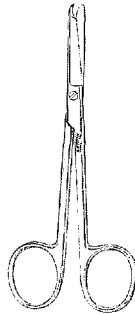

9-102

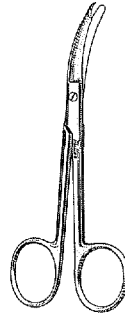

9-103

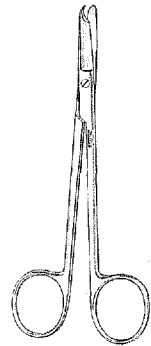

9-104

- 9-100 SPENCER Stitch Scissors 3½" (8.9 cm), delicate
- 9-101 SHORTBENT Stitch Scissors 3½" (8.9 cm), curved, delicate
- 9-102 LITTAUER JR. Stitch Scissors 4½" (11.4 cm), light pattern
- 9-103 NORTHBENT Stitch Scissors 4¾" (12.1 cm), curved, light pattern
- 9-104 LITTAUER Stitch Scissors 5½" (14 cm), standard pattern
- 9-108 MILTEX Stitch Scissors 4½" (11.4 cm), angled, delicate
- 9-110 O'BRIEN Stitch Scissors 3¾" (9.5 cm), angled, sharp points

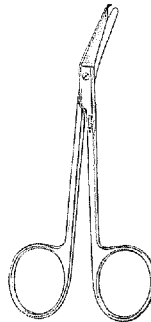

9-108

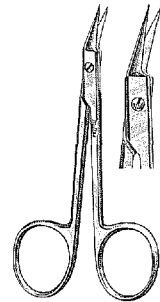

9-110

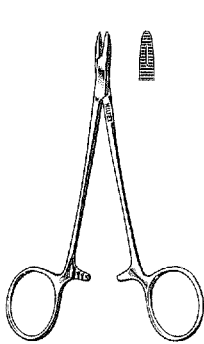

8-4

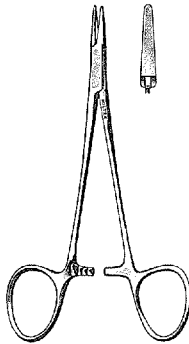

8-6

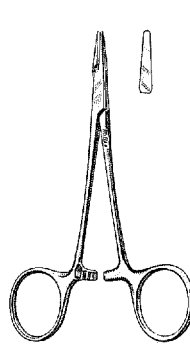

8-7

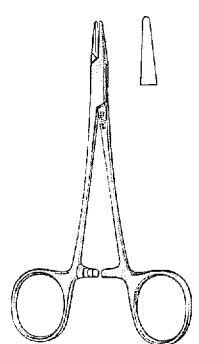

8-8

- 8-4 DERF Needle Holder 4¾" (12.1 cm)
- 8-6 WEBSTER Needle Holder 5" (12.7 cm), delicate smooth jaws, standard pattern
- 8-7 WEBSTER Needle Holder 4¾" (12.1 cm), extra delicate smooth jaws
- 8-8 HALSEY Needle Holder 5" (12.7 cm), smooth jaws
- 8D-36 HALSEY Needle Holder 5" (12.7 cm), serrated jaws

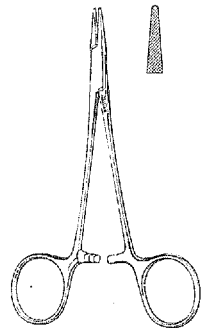

8D-36

For additional Needle Holders see pages 112 - 121

For Carb-N-Sert Needle Holders with tungsten carbide inserts see pages 123 - 130

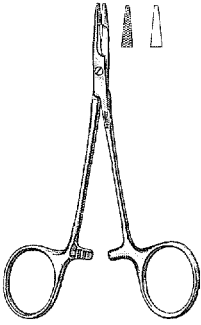

8-14
8-14A

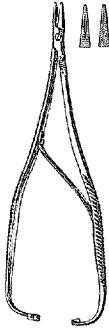

8-26

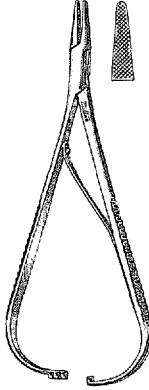

8-28

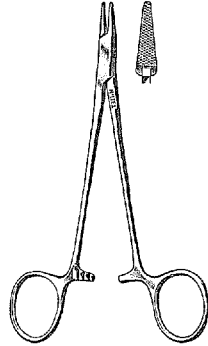

8-40

- 8-14 OLSEN-HEGAR Needle Holder-Scissor Combination 4¾" (12.1 cm), serrated jaws, extra delicate
- 8-14A OLSEN-HEGAR Needle Holder-Scissor Combination 4¾" (12.1 cm), smooth jaws, extra delicate
- 8-26 BOYNTON Needle Holder 5" (12.7 cm), delicate
- 8-28 MATHIEU Needle Holder 5½" (14 cm), with spring handles
- 8-40 BAUMGARTNER Needle Holder 5½" (14 cm)
- 18-1800 KALT Needle Holder 5¼" (13.3 cm), standard model, delicate jaws
- 18-1810 GREEN Needle Holder and Suturing Forceps 4¼" (10.8 cm), angled jaws, double end

For additional Needle Holders see pages 112 - 121

For Carb-N-Sert Needle Holders with tungsten carbide inserts see pages 123 - 130

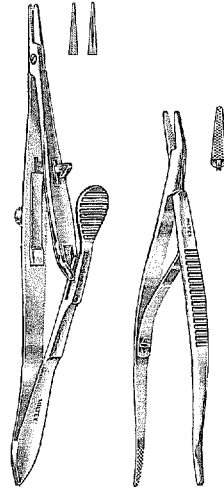

18-1800

18-1810

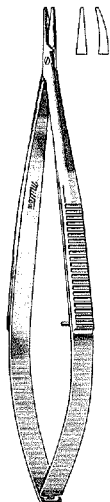

18-1820
18-1824



18-1828
18-1832

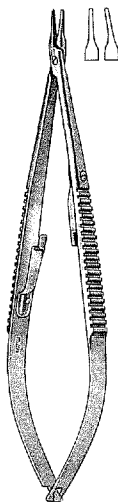

18-1831
18-1833

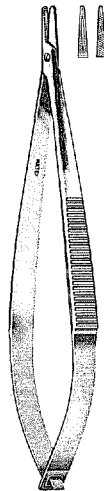

18-1834

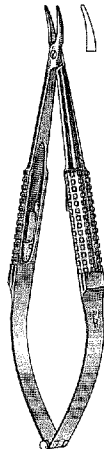

18-1838
18-1839

- 18-1820 CASTROVIEJO Needle Holder 5½" (14 cm), straight, without lock
- 18-1824 CASTROVIEJO Needle Holder 5½" (14 cm), curved, without lock
- 18-1828 CASTROVIEJO Needle Holder 5½" (14 cm), straight, with lock
- 18-1832 CASTROVIEJO Needle Holder 5½" (14 cm), curved, with lock
- 18-1831 CASTROVIEJO Needle Holder 5½" (14 cm), straight, extra delicate jaws, with lock
- 18-1833 CASTROVIEJO Needle Holder 5½" (14 cm), curved, extra delicate jaws, with lock
- 18-1834 PATON Needle Holder 4½" (11.4 cm), straight, without lock
- 18-1838 BARRAQUER Needle Holder 5" (12.7 cm), curved, without lock, 10 mm wide hollow round handles
- 18-1839 BARRAQUER Needle Holder 5" (12.7 cm), curved, with lock, 10 mm wide hollow round handles
- 18-1840 BARRAQUER Needle Holder 5½" (13 cm), curved, delicate tapered jaws, 8 mm wide hollow round handles

For additional Needle Holders see pages 112 - 121

For Carb-N-Sert Needle Holders with tungsten carbide inserts see pages 123 - 130

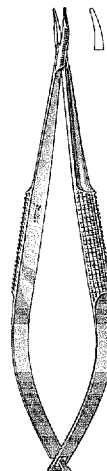

18-1840



6-104

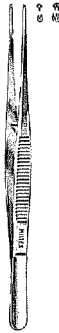

6-106
6-108



6-107



6-118



6-118A



6-118XL



17-2510

- 6-104 SEMKEN Dressing Forceps 5" (12.7 cm), serrated
- 6-106 SEMKEN Tissue Forceps 5" (12.7 cm), 1 x 2 teeth
- 6-107 SEMKEN Tissue Forceps 5" (12.7 cm), 1 x 2 teeth, curved tips
- 6-108 SEMKEN Tissue Forceps 5" (12.7 cm), 2 x 3 teeth
- 6-118 ADSON Dressing Forceps 4 3/4" (12.1 cm), serrated, delicate
- 6-118A ADSON Dressing Forceps 4 3/4" (12.1 cm), serrated, delicate, angled
- 6-118XL ADSON Dressing Forceps 4 3/4" (12.1 cm), serrated, lightweight, fenestrated handles
- 17-2510 Micro ADSON Dressing Forceps 4 3/4" (12.1 cm), serrated tips, 0.5 mm wide
- 6-120 ADSON Tissue Forceps 4 3/4" (12.1 cm), 1 x 2 teeth, delicate
- 6-120A ADSON Tissue Forceps 4 3/4" (12.1 cm), 1 x 2 teeth, delicate, angled
- 6-120XL ADSON Tissue Forceps 4 3/4" (12.1 cm), 1 x 2 teeth, lightweight, fenestrated handles



6-120

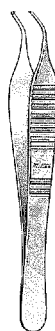

6-120A



6-120XL

For additional Dressing and Tissue Forceps see pages 64 - 82

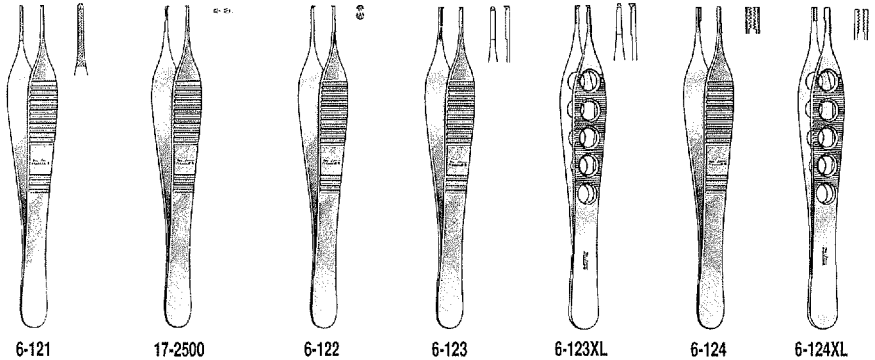

- 6-121** ADSON Tissue Forceps 4¾" (12.1 cm), 1 x 2 teeth, and cross serrated tips, delicate
- 17-2500** Micro ADSON Tissue Forceps 4¾" (12.1 cm), tips 0.5 mm wide, 1 x 2 teeth
- 6-122** ADSON Tissue Forceps 4¾" (12.1 cm), 2 x 3 teeth, delicate
- 6-123** ADSON Tissue and Suture Forceps 4¾" (12.1 cm), 1 x 2 teeth with tying platform
- 6-123XL** ADSON Tissue Forceps 4¾" (12.1 cm), w/platform, 1 x 2 teeth, lightweight, fenestrated handles
- 6-124** BROWN-ADSON Tissue Forceps 4¾" (12.1 cm), 7 x 7 side grasping teeth
- 6-124XL** BROWN-ADSON Tissue Forceps 4¾" (12.1 cm), 7 x 7 side grasping teeth, lightweight, fenestrated handles
- 6-125** DeBAKEY-ADSON Tissue Forceps 4¾" (12.1 cm), atraumatic tips 1.5 mm wide
- 24-570XL** DeBAKEY Tissue Forceps 6" (15.2 cm), atraumatic tips, 1.5 mm wide, lightweight, fenestrated handles
- 6-126** BROWN-ADSON Tissue Forceps 4¾" (12.1 cm), 7 x 7 side grasping teeth, angular

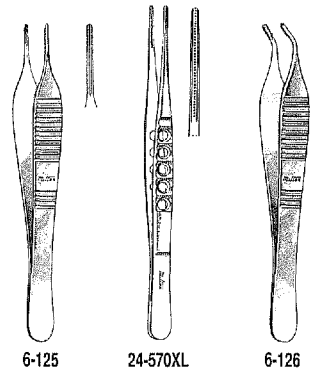

For additional Dressing and Tissue Forceps see pages 64 - 82



18-780

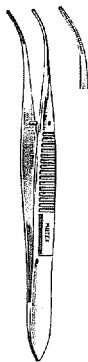

18-782

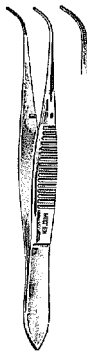

18-784



18-779

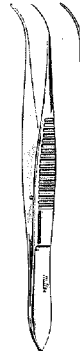

18-781



18-783

EYE DRESSING FORCEPS 4" (10.2 cm), SERRATED TIPS

Standard Pattern
0.8 mm wide tips

18-780 Straight
18-782 Half curved
18-784 Full curved

Extra Delicate Pattern
0.5 mm wide tips

18-779 Straight
18-781 Half curved
18-783 Full curved

For additional Dressing and Tissue Forceps see pages 64 - 82



18-786
18-787

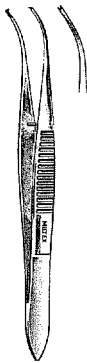

18-788

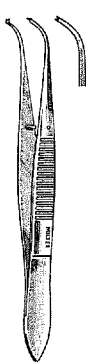

18-790



18-785

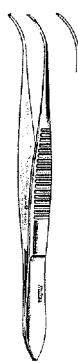

18-789

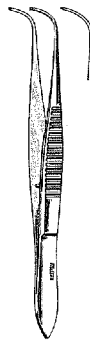

18-791

IRIS TISSUE FORCEPS 4" (10.2 cm), 1 x 2 TEETH

Standard Pattern 0.8 mm wide tips		Extra Delicate Pattern 0.5 mm wide tips	
18-786	Straight	18-785	Straight
18-787	Straight (Non Magnetic)	18-789	Half curved
18-788	Half curved	18-791	Full curved
18-790	Full curved		
18-850	GRAEFE Tissue Forceps 4" (11.2 cm), standard jaws 4.5 mm wide, with fine teeth		
18-854	GRAEFE Tissue Forceps 4" (11.2 cm), standard jaws 4.5 mm wide, with fine teeth, with catch		

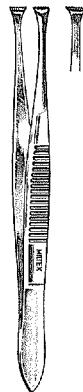

18-850



18-854

For additional Dressing & Tissue Forceps see pages 64 - 82



18-866
18-868



18-1107

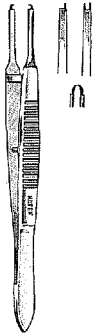

18-876
18-878

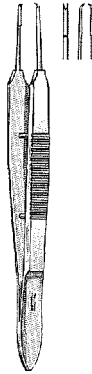

18-950

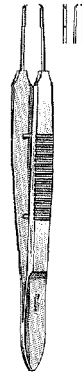

18-951
18-952



18-953 to 18-955

- 18-866 BISHOP-HARMON Dressing Forceps 3 $\frac{3}{4}$ " (8.6 cm), fine cross serrated tips 0.5 mm wide
- 18-868 BISHOP-HARMON Tissue Forceps 3 $\frac{3}{4}$ " (8.6 cm), standard 0.7 mm 1 x 2 teeth
- 18-1107 Swiss Cilia and Suture Forceps 3 $\frac{3}{4}$ " (9.5 cm), precision fitted diagonal jaws 3 mm wide
- 18-876 CASTROVIEJO (ALVIN) Fixation Forceps 3 $\frac{3}{4}$ " (9.5 cm), straight, 1 x 1 curved teeth extending beyond each other
- 18-878 CASTROVIEJO Fixation Forceps 3 $\frac{3}{4}$ " (9.5 cm), straight, 2 x 2 curved teeth extending beyond each other
- 18-950 CASTROVIEJO Suturing Forceps 4" (10.2 cm), 1 x 2 teeth 0.9 mm, with tying platform
- 18-951 CASTROVIEJO Suturing Forceps 4" (10.2 cm), 1 x 2 teeth 0.3 mm, with tying platform
- 18-952 CASTROVIEJO Suturing Forceps 4" (10.2 cm), 1 x 2 teeth 0.6 mm, with tying platform
- 18-953 CASTROVIEJO Micro Suturing Forceps 4" (10.2 cm), with 11 mm wide handles, 1 x 2 teeth 0.12 mm, with tying platform
- 18-954 CASTROVIEJO Suturing Forceps 4" (10.2 cm), with 11 mm wide handles, 1 x 2 teeth 0.6 mm, with tying platform
- 18-955 CASTROVIEJO Suturing Forceps 4" (10.2 cm), with 11 mm wide handles, 1 x 2 teeth 0.9 mm, with tying platform

For additional Fixation and Suturing Forceps see pages 238, 244 - 248 & 251



21-430



26-1084
26-1086



33-121



18-412
18-414



18-416

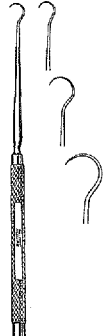

21-85 to 21-87

- 21-430 MILTEX Tissue Twist Hook 5½" (14 cm)
- 26-1084 FRAZIER Skin Hook 5" (12.7 cm), sharp point
- 26-1086 FRAZIER Skin Hook 5" (12.7 cm), blunt point
- 33-121 SELTZNER Dermal Biopsy Hook 4½" (11.4 cm), sharp point
- 18-412 TYRELL Skin Hook 5" (12.7 cm), sharp point
- 18-414 TYRELL Skin Hook 5" (12.7 cm), blunt point
- 18-416 GUTHRIE Hook 5" (12.7 cm), sharp double prongs 1.5 mm wide
- 21-85 KLEINERT-KUTZ Hook 5" (12.7 cm), small size 3 mm dia.
- 21-86 KLEINERT-KUTZ Hook 5" (12.7 cm), medium size 5 mm dia.
- 21-87 KLEINERT-KUTZ Hook 5" (12.7 cm), large size 7 mm dia.
- 21-88 GILLIES (CONVERSE) Skin Hook 7" (17.8 cm), large size
- 21-89 GILLIES (CONVERSE) Skin Hook 7" (17.8 cm), small size



21-88
21-89

For additional Hooks see pages 188 - 194



21-90 to 21-94



21-102
21-103



21-144



21-152



21-153

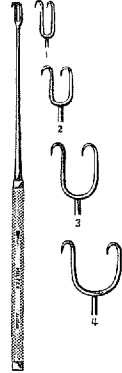

21-154 to 21-160

- 21-90 COTTLE Skin Hook 5½" (14 cm), small, shallow curve
- 21-92 COTTLE Skin Hook 5½" (14 cm), small, deep curve
- 21-94 COTTLE Skin Hook 5½" (14 cm), large, deep curve
- 21-102 FREER Skin Hook 6" (15.2 cm), sharp double prongs 2.5 mm wide
- 21-103 FREER Skin Hook 6" (15.2 cm), blunt double prongs 2.5 mm wide
- 21-144 COTTLE Double Hook 5½" (14 cm), two sharp prongs 12 mm wide
- 21-152 MILTEX Skin Hook 4¾" (12.1 cm), sharp prong 2 mm dia.
- 21-153 JOSEPH Single Hook 6¼" (15.9 cm), one sharp prong
- 21-154 JOSEPH Double Hook 6¼" (15.9 cm), two sharp prongs 2 mm
- 21-156 JOSEPH Double Hook 6¼" (15.9 cm), two sharp prongs 5 mm
- 21-158 JOSEPH Double Hook 6¼" (15.9 cm), two sharp prongs 7 mm
- 21-160 JOSEPH Double Hook 6¼" (15.9 cm), two sharp prongs 10 mm



18-100
18-102



18-439

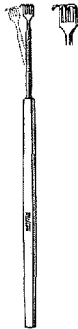

11D-27

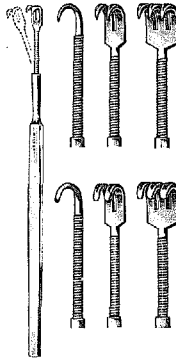

11-30 to 11-40

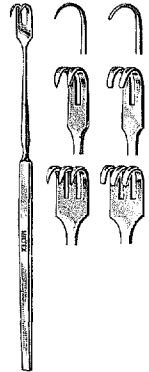

11-50 to 11-60

- 18-100 ROLLET Retractor 5¼" (13.3 cm), with 4 sharp prongs
- 18-102 KNAPP Retractor 5¼" (13.3 cm), with 4 blunt prongs
- 18-439 McGANNON Retractor 5" (12.7 cm), fenestrated blade 2.5 mm wide
- 11D-27 Flexible Neck Rake Retractor 5" (12.7 cm), 3 sharp prongs

RAKE RETRACTORS 6" (15.2 cm)

Sharp	With Flexible Neck	Blunt
11-30	1 prong	11-36
11-32	2 prongs	11-38
11-34	3 prongs	11-40

RAKE RETRACTORS 6" (15.2 cm)

Sharp	With Rigid Neck	Blunt
11-50	1 prong	11-56
11-52	2 prongs	11-58
11-54	3 prongs	11-60

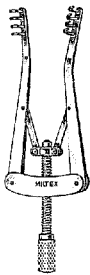

11-12
11-13

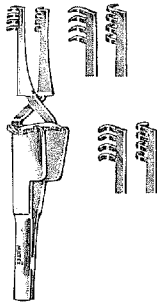

11-14
11-16

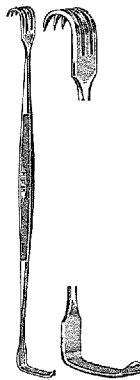

11-74
11-76



11-80
11-81

- 11-12 ALM Retractor 2 $\frac{3}{4}$ " (7 cm), spread 2 $\frac{1}{4}$ " (5.7 cm), prongs
 $\frac{1}{8}$ " (.32 cm) deep
- 11-13 ALM Retractor 3 $\frac{3}{8}$ " (9.8 cm), spread 3" (7.6 cm), prongs
 $\frac{1}{2}$ " (1.3 cm) deep
- 11-14 MILTEX Cross Action Retractor 4" (10.2 cm), sharp prongs
- 11-16 MILTEX Cross Action Retractor 4" (10.2 cm), blunt prongs
- 11-74 SENN Retractor 6 $\frac{3}{8}$ " (16.2 cm), sharp, double end
- 11-76 SENN Retractor 6 $\frac{3}{8}$ " (16.2 cm), blunt, double end
- 11-80 MATHIEU Retractor 6 $\frac{1}{2}$ " (16.5 cm), sharp, double end
- 11-81 MATHIEU Retractor 6 $\frac{1}{2}$ " (16.5 cm), blunt, double end

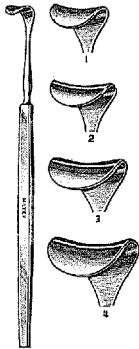

18-110 to 18-116



18-570



33-140
33-142



40-94
40-96

- 18-110** DESMARRES Eye Lid Retractor 5½" (14 cm), size 1, 11 mm
- 18-112** DESMARRES Eye Lid Retractor 5½" (14 cm), size 2, 13 mm
- 18-114** DESMARRES Eye Lid Retractor 5½" (14 cm), size 3, 15 mm
- 18-116** DESMARRES Eye Lid Retractor 5½" (14 cm), size 4, 17 mm
- 18-570** GREEN Spatula 6" (15.2 cm), slightly curved ends 4 x 14 mm and 5 x 16 mm
- 33-140** Finger Ring Cutter 6½" (16.5 cm), with circular saw blade, chrome
- 33-142** Replacement Blade for Finger Ring Cutter, chrome
- 40-94** LOCKE Elevator 4½" (11.4 cm), small blade 3 x 15 mm
- 40-96** LOCKE Elevator 5" (12.1 cm), large blade 5 x 20 mm
- 18-660** Flexible Stainless Ruler 6" (15.2 cm) x ½" (1.3 cm), graduated in ½" (.8 mm) fractions & mm

For Measuring Calipers see page 239



18-660



33-200

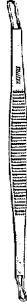

33-201
33-202



33-203



33-204
33-206



33-210

- 33-200** SCHAMBERG Comedone Extractor 3¾" (9.5 cm), with square loop ends
- 33-201** SCHAMBERG Comedone Extractor 3¾" (9.5 cm), standard pattern with crimped small loop
- 33-202** SCHAMBERG Comedone Extractor 3¾" (9.5 cm), standard pattern with extra fine loops, small loop crimped
- 33-203** Comedone Extractor 4" (10.2 cm), double end, flat and wire end expressors
- 33-204** SAALFIELD Comedone Extractor 5¼" (14.6 cm), with acne lancet, professional pattern
- 33-206** SAALFIELD Comedone Extractor 4¼" (10.8 cm), with acne lancet, professional pattern
- 33-210** UNNA Comedone Extractor 5¼" (14.6 cm), spoon ends



33-214



33-215
33-216



33-230



33-234



33-232



33-500

- 33-214 MILTEX Comedone Extractor 6" (15.2 cm), one fenestrated cup and one delicate curved lancet with protective cap
- 33-215 GREG Comedone Extractor 5" (12.7 cm), one fenestrated cup and chuck with interchangeable No. 65 lancet blade, protected by cap
- 33-216 Replacement Blade No. 65 for No. 33-215 Comedone Extractor
- 33-230 Finger Nail Drill 4" (10.2 cm), standard pattern, complete with 3 drill points stored in handle
- 33-232 Finger Nail Drill 4½" (11.4 cm), with Chuck Head, complete with 3 drill points stored in handle
- 33-234 Set of 3 Drill Points, small, medium and large size, for Finger Nail Drills, chrome
- 33-500 MILTEX Depilatory Forceps 5¼" (13.3 cm), flat square tips with deep serrations



Dermal Instruments

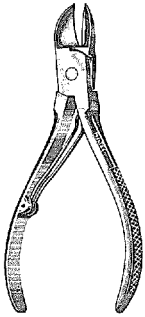

40-200



40-205
40-207

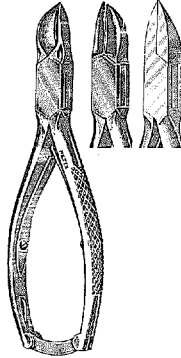

40-210
40-212

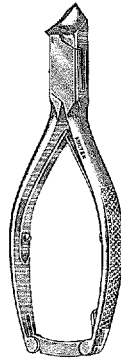

40-215

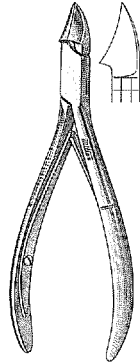

40-217

- 40-200 Nail Nipper 4½" (11.4 cm), concave jaws, single spring, chrome
- 40-205 Nail Nipper 4½" (11.4 cm), concave jaws, barrel spring, chrome
- 40-207 Nail Nipper 5½" (14 cm), concave jaws, barrel spring, chrome
- 40-210-CH Nail Nipper 5½" (14 cm), concave jaws, double spring, chrome
- 40-210-SS Nail Nipper 5½" (14 cm), concave jaws, double spring, stainless
- 40-212-CH Nail Nipper 5½" (14 cm), straight jaws, double spring, chrome
- 40-212-SS Nail Nipper 5½" (14 cm), straight jaws, double spring, stainless
- 40-215-CH Nail Nipper 5½" (14 cm), angled concave jaws, double spring, chrome
- 40-215-SS Nail Nipper 5½" (14 cm), angled concave jaws, double spring, stainless
- 40-217 Nail Nipper 5" (12.7 cm), concave jaws, double spring, stainless
- 40-219 Double Action Nail Nipper 6" (15.2 cm), sharp concave jaws, barrel spring, stainless

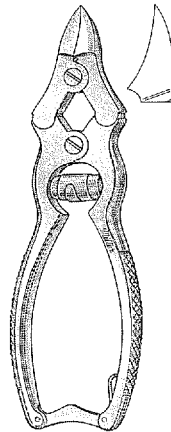

40-219

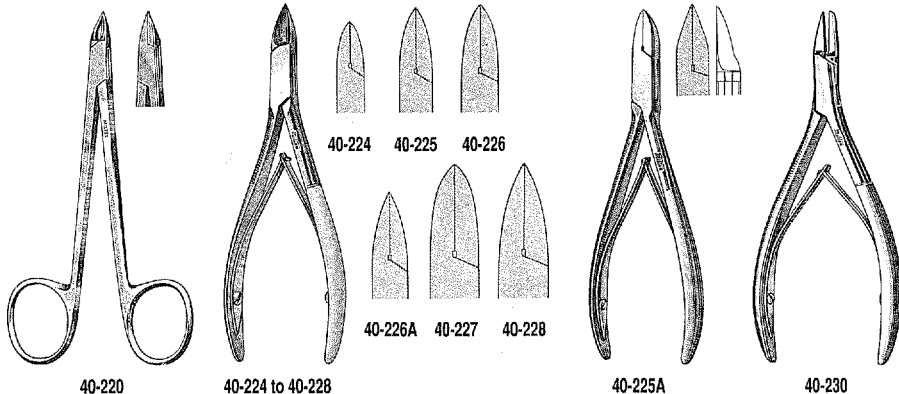

- 40-220** Tissue and Cuticle Nipper 4" (10.2 cm), straight jaws, ring handles, chrome
- 40-224** Nail Splitter 4" (10.2 cm), straight jaws, double spring, stainless
- 40-225A** Nail Splitter 4½" (11.4 cm), delicate straight jaws, double spring, stainless
- 40-225-CH** Nail Splitter 4½" (11.4 cm), straight jaws, single spring, chrome
- 40-225-SS** Nail Splitter 4½" (11.4 cm), straight jaws, double spring, stainless
- 40-226A** Nail Splitter 5" (12.7 cm), straight jaws, extra narrow, double spring, stainless
- 40-226-CH** Nail Splitter 5" (12.7 cm), straight jaws, single spring, chrome
- 40-226-SS** Nail Splitter 5" (12.7 cm), straight jaws, double spring, stainless
- 40-227-CH** Nail Splitter 6" (15.2 cm), straight jaws, single spring, chrome
- 40-227-SS** Nail Splitter 6" (15.2 cm), straight jaws, double spring, stainless
- 40-228** Nail Splitter 6" (15.2 cm), straight jaws, extra narrow, double spring, stainless
- 40-230** Nail Splitter 5" (12.7 cm), English Anvil Pattern, double spring, stainless
- 40-234** PLATYPUS Nail Pulling Forceps 5½" (14 cm), standard wide jaws, stainless
- 40-235** PLATYPUS Nail Pulling Forceps 5½" (14 cm), narrow jaws, stainless

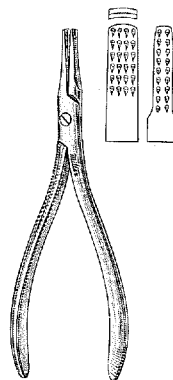

40-234
40-235

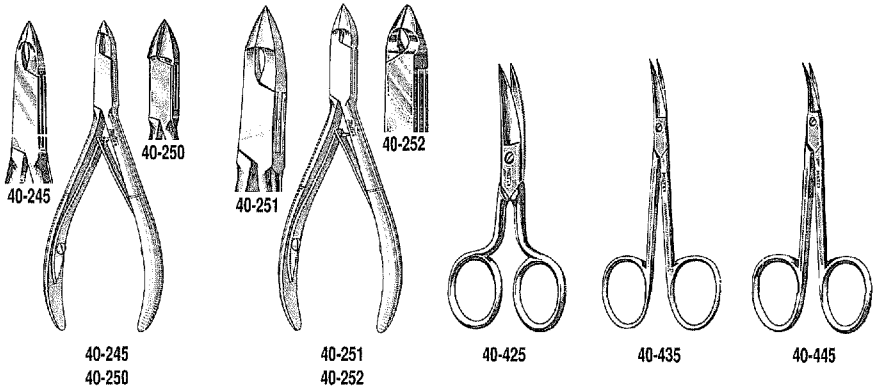

- 40-245-CH** Tissue and Cuticle Nipper 4" (10.2 cm), convex jaws, chrome
- 40-245-SS** Tissue and Cuticle Nipper 4" (10.2 cm), convex jaws, stainless
- 40-250-CH** Tissue and Cuticle Nipper 4½" (11.4 cm), convex jaws, chrome
- 40-250-SS** Tissue and Cuticle Nipper 4½" (11.4 cm), convex jaws, stainless
- 40-251-CH** Tissue and Cuticle Nipper 5" (12.7 cm), convex jaws, chrome
- 40-251-SS** Tissue and Cuticle Nipper 5" (12.7 cm), convex jaws, stainless
- 40-252** Tissue and Cuticle Nipper 5" (12.7 cm), convex jaws, heavy pattern, stainless
- 40-425** Nail Scissors 3½" (8.9 cm), curved blades, chrome
- 40-435** Cuticle Scissors 3½" (8.9 cm), curved blades, standard pattern, chrome
- 40-445** Cuticle Scissors 3½" (8.9 cm), curved blades, extra delicate, chrome
- 40-260** Ingrown Nail Splitting Scissors 6" (15.2 cm), stainless

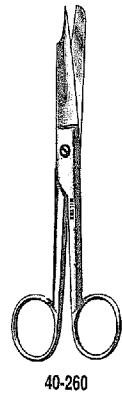



34-50
34-52

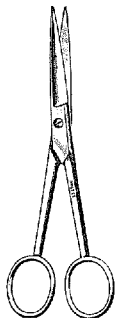

34-80

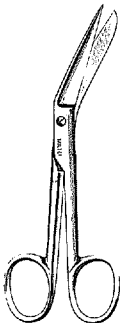

34-92

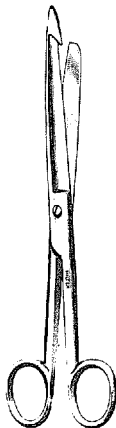

34-98



30-2605

- 34-50 VIRCHOW Brain Sectioning Knife, blade 180 mm x 20 mm, double edge
- 34-52 VIRCHOW Brain Sectioning Knife, blade 250 mm x 40 mm, double edge
- 34-80 Dissecting Scissors 4½" (11.4 cm), straight, two sharp points, economy grade
- 34-92 RICHTER Dissecting Scissors 5" (12.7 cm), angular blades, one sharp and one blunt point
- 34-98 Enterotomy Scissors 8" (20.3 cm), with hook blade
- 30-2605 DUBOIS Scissors 10½" (26.7 cm), curved, blunt points, extra heavy pattern
- 25-360 GLUCK Rib Shears 8½" (21.6 cm)

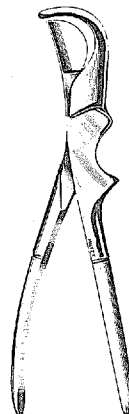

25-360

For a complete selection of Scissors see pages 18 - 52



Post Mortem Instruments

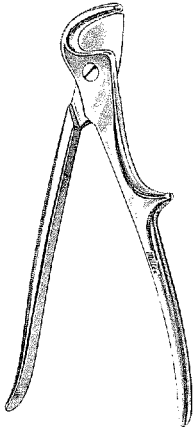

25-362

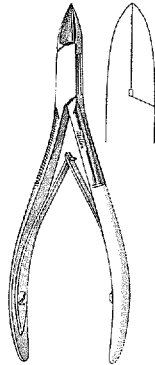

40-227-SS

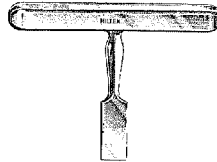

34-210

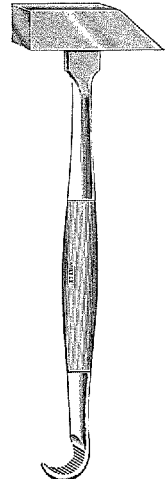

34-220

- 25-362 STILLE Pattern Rib Shears 8½" (21.6 cm)
- 40-227-SS LITTAUER-LISTON Bone Cutting Forceps 6" (15.2 cm), straight 20 mm blades
- 34-210 VIRCHOW Skull Breaker 3" (7.6 cm), blade ½" (1.3 cm) wide
- 34-220 Post Mortem Hammer 9½" (24.1 cm), with hook handle
- 34-250 Dissecting Tenaculum 6½" (16.5 cm), sharp point
- 34-256 Aneurysm Needle 6½" (16.5 cm), blunt tip with eye



34-250



34-256

INDEX

Suggested Surgical Instrument Sets

The following lists have been compiled as a guide in determining basic instrumentation requirements.

	Page Nos.
General Surgery	555-561
Genito-Urinary Surgery	562-564
Rectal Surgery	565-566
Obstetrical and Gynecological Surgery	567-570
Neurosurgery	571-575
Orthopedic Surgery	576-582
Thoracic and Cardiac Surgery	583-588
Ophthalmic Surgery	589-591
Ear, Nose and Throat Surgery	592-596
Suture	597



Surgical Instrument Sets

GENERAL SURGERY

BASIC LAPAROTOMY SET

Quantity	Catalog No.	Description
1 ea.	2-104-SS	Yankauer Suction Tube
1 ea.	3-70	Forceps Holder 8" (20.3 cm)
1 ea.	3-71	Forceps Holder 10" (25.4 cm)
1 ea.	3-72	Forceps Holder 12" (30.5 cm)
2 ea.	4-7	Knife Handle No. 3
2 ea.	4-8	Knife Handle No. 4
1 ea.	4-9	Knife Handle No. 7
1 ea.	5-16	Operating Scissors 5½" (14 cm), str. S/B
1 ea.	5-124TC	Mayo Dissecting Scissors 6¾" (17.1 cm), str., Carb-N-Sert blades
1 ea.	5-126TC	Mayo Dissecting Scissors 6¾" (17.1 cm), cvd., Carb-N-Sert blades
1 ea.	5-182TC	Metzenbaum Scissors 7" (17.8 cm), cvd., Carb-N-Sert blades
1 ea.	5-186TC	Metzenbaum Scissors 9" (22.9 cm), str., Carb-N-Sert blades
1 ea.	5-188TC	Metzenbaum Scissors 9" (22.9 cm), cvd., Carb-N-Sert blades
1 ea.	6-8	Thumb Dressing Forceps 5½" (14 cm)
1 ea.	6-44	Tissue Forceps 5½" (14 cm), 1 x 2 T
1 ea.	6-118	Adson Dressing Forceps 4¾" (12.1 cm), serr.
1 ea.	6-120	Adson Tissue Forceps 4¾" (12.1 cm), 1 x 2 T
1 ea.	6-144	Russian Tissue Forceps 8" (20.3 cm)
1 ea.	6-166	Cushing Dressing Forceps 7" (17.8 cm), serr.
1 ea.	6-168	Cushing Tissue Forceps 7" (17.8 cm), 1 x 2 teeth
6 ea.	7-2	Halsted Mosquito Forceps 5" (12.7 cm), str.
6 ea.	7-4	Halsted Mosquito Forceps 5" (12.7 cm), cvd.
6 ea.	7-36	Kelly Forceps 5½" (14 cm), str.
12 ea.	7-38	Kelly Forceps 5½" (14 cm), cvd.
6 ea.	7-138	Rochester-Pean Forceps 6¼" (15.9 cm), cvd.
2 ea.	7-142	Rochester-Pean Forceps 8" (20.3 cm), cvd.
4 ea.	7-150	Rochester-Ochsner Forceps 6¼" (15.9 cm), str., 1 x 2 teeth
1 ea.	7-202	Mixer Forceps 7¾" (18.4 cm), fully cvd.
1 ea.	7-206	Mixer Forceps 9" (22.9 cm)
1 ea.	7-210	Baby Mixer Forceps 5¼" (13.3 cm), fully cvd.
8 ea.	7-506	Backhaus Towel Clamp 5¼" (13.3 cm)
1 ea.	7-600	Foerster Sponge Forceps 9½" (24.1 cm), str. serr.
1 ea.	8-44TC	Mayo-Hegar Needle Holder 6" (15.2 cm), Carb-N-Sert jaws
1 ea.	8-46TC	Mayo-Hegar Needle Holder 7" (17.8 cm), Carb-N-Sert jaws

Cont'd on next page

Surgical Instrument Sets



GENERAL SURGERY

BASIC LAPAROTOMY SET (Cont'd)

Quantity	Catalog No.	Description
1 ea.	8-48TC	Mayo-Hegar Needle Holder 8" (20.3 cm), Carb-N-Sert jaws
1 ea.	8-130TC	Mayo-Hegar Needle Holder 10½" (26.7 cm), Carb-N-Sert jaws
1 ea.	10-312	Poole Suction Tube, str.
2 ea.	11-120	Goelet Retractor
1 ea.	11-122	U.S. Army Retractor, Set of 2
1 ea.	11-130	Ribbon Retractor ¾" (1.9 cm) x 13" (33 cm)
1 ea.	11-134	Ribbon Retractor 1¼" (3.2 cm) x 13" (33 cm)
1 ea.	11-140	Ribbon Retractor 2" (5.1 cm) x 13" (33 cm)
1 ea.	11-202	Deaver Retractor 1" (2.5 cm) x 12" (30.5 cm)
1 ea.	11-208	Deaver Retractor 2" (5.1 cm) x 12" (30.5 cm)
1 ea.	11-246	Richardson Retractor, small
1 ea.	11-248	Richardson Retractor, large
1 ea.	11-267	Kelly Retractor 2½" (6.4 cm) x 2" (5.1 cm)
1 ea.	11-432	Balfour Retractor w/interchangeable blades
2 ea.	14-48	Lahey Gall Duct Forceps 7½" (19.1 cm)
2 ea.	16-6	Allis Tissue Forceps 6" (15.2 cm), 4 x 5 T
2 ea.	16-12	Allis Tissue Forceps 10" (25.4 cm)
2 ea.	16-44	Babcock Tissue Forceps 6¼" (15.9 cm)
2 ea.	16-48	Babcock Tissue Forceps 9¼" (23.5 cm)
1 ea.	18-660	Stainless Steel Ruler
4 ea.	22-662	Schmidt Tonsil Forceps 7½" (19.1 cm)
1 ea.	24-572	DeBakey Tissue Forceps 8" (20.3 cm)

MINOR BASIC INSTRUMENT SET

Quantity	Catalog No.	Description
1 ea.	2-104-SS	Yankauer Suction Tube 11¾" (29.8 cm)
1 ea.	4-7	Knife Handle No. 3
1 ea.	5-16	Operating Scissors 5½" (14 cm), str. S/B
1 ea.	5-120TC	Mayo Dissecting Scissors 5½" (14 cm), str. Carb-N-Sert blades
1 ea.	5-122TC	Mayo Dissecting Scissors 5½" (14 cm), cvd., Carb-N-Sert blades
1 ea.	5-182TC	Metzenbaum Scissors 7" (17.8 cm), cvd. Carb-N-Sert blades
1 ea.	6-8	Dressing Forceps 5½" (14 cm)
4 ea.	7-2	Halsted Mosquito Forceps 5" (12.7 cm), str.

Cont'd on next page



Surgical Instrument Sets

GENERAL SURGERY

MINOR BASIC INSTRUMENT SET (Cont'd)

Quantity	Catalog No.	Description
4 ea.	7-4	Halsted Mosquito Forceps, 5" (12.7 cm), cvd.
4 ea.	7-38	Kelly Forceps, 5½" (14 cm), cvd.
6 ea.	7-506	Backhaus Towel Clamp 5¼" (13.3 cm)
1 ea.	7-600	Foerster Sponge Forceps 9½" (24.1 cm), str. serr.
1 ea.	8-44TC	Mayo-Hegar Needle Holder 6" (15.2 cm), Carb-N-Sert jaws
1 ea.	8-46TC	Mayo-Hegar Needle Holder 7" (17.8 cm), Carb-N-Sert jaws
1 ea.	8-50TC	Crile Wood Needle Holder 6" (15.2 cm), Carb-N-Sert jaws
1 ea.	10-26-SS	Probe with Eye 5½" (14 cm)
1 ea.	10-82	Grooved Director with Probe Tip and Tongue Tie 5½" (14 cm)
2 ea.	11-74	Senn Retractor, double end, sharp
2 ea.	11-552	Volkman Retractor, 3 prong, blunt
2 ea.	16-6	Allis Tissue Forceps 6" (15.2 cm), 4 x 5 T
1 ea.	19-574	Frazier Ferguson Suction Tube 9 Fr. (3 mm)
2 ea.	22-662	Schmidt Hemostatic Forceps 7½" (19.1 cm), slight curve

PLASTIC SET

Quantity	Catalog No.	Description
1 ea.	5-304	Iris Scissors 4½" (11.4 cm), str.
1 ea.	5-306	Iris Scissors 4½" (11.4 cm), cvd.
1 ea.	5-180	Baby Metzenbaum Scissors 5½" (14 cm), cvd.
1 ea.	5-270	Plastic Surgery Scissors 4¾" (12.1 cm), str. S/S
1 ea.	5-290	Ragnell Scissors 5" (12.7 cm)
1 ea.	6-118	Adson Dressing Forceps, 4¾" (12.1 cm), serr.
1 ea.	6-120	Adson Tissue Forceps, 4¾" (12.1 cm), 1 x 2 T
1 ea.	6-124	Brown-Adson Tissue Forceps
2 ea.	7-2	Halsted Mosquito Forceps 5" (12.7 cm), str.
2 ea.	7-4	Halsted Mosquito Forceps 5" (12.7 cm), cvd.
1 ea.	7-38	Kelly Forceps 5½" (14 cm), cvd.
1 ea.	7-48	Crile Forceps 6¼" (15.9 cm), cvd.
2 ea.	7-255	Gemini-Mixer Forceps 5½" (14 cm), full curved
8 ea.	7-504	Backhaus Towel Clamp 3½" (8.9 cm)

Cont'd on next page

GENERAL SURGERY

PLASTIC SET (Cont'd)

Quantity	Catalog No.	Description
1 ea.	7-600	Foerster Sponge Forceps 9½" (24.1 cm)
1 ea.	8-6TC	Webster Needle Holder 5" (12.7 cm), Carb-N-Sert jaws
1 ea.	8-50TC	Crile Wood N.H. 6" (15.2 cm), Carb-N-Sert jaws
1 ea.	11-2	Jansen Retractor
2 ea.	11-74	Senn Retractor, sharp
1 ea.	11-602	Weitlaner Retractor 4" (10.2 cm), blunt
2 ea.	16-6	Allis Tissue Forceps 6" (15.2 cm), 4 x 5 T
1 ea.	19-574	Frazier Ferguson Suction Tube 9 Fr.
2 ea.	21-153	Joseph Skin Hook, single
2 ea.	21-156	Joseph Skin Hook, double 5 mm

HAND SET

Quantity	Catalog No.	Description
2 ea.	4-7	Knife Handle No. 3
1 ea.	5-124TC	Mayo Dissecting Scissors 6¾" (17.1 cm), str. Carb-N-Sert blades
1 ea.	5-182A-TC	Meiz Scissors 7" (17.8 cm), cvd. del. Carb-N-Sert blades
1 ea.	5-182TC	Metz Scissors 7" (17.8 cm), cvd. Carb-N-Sert blades
1 ea.	5-304TC	Iris Scs 4¾" (11.4 cm), str. Carb-N-Sert blades
2 ea.	6-8	Dressing Forceps 5½" (14 cm)
2 ea.	6-44	Tissue Forceps 5½" (14 cm), 1 x 2 T
2 ea.	6-118	Adson Dressing Forceps 4¾" (12.1 cm), serr.
2 ea.	6-120	Adson Tissue Forceps 4¾" (12.1 cm), 1 x 2 T
6 ea.	7-2	Halsted Mosquito Forceps 5" (12.7 cm), str.
6 ea.	7-4	Halsted Mosquito Forceps 5" (12.7 cm), cvd.
6 ea.	7-38	Kelly Forceps 5½" (14 cm), cvd.
4 ea.	7-504	Backhaus Towel Clamp 3½" (8.9 cm)
2 ea.	7-604	Foerster Sponge Forceps 7" (17.8 cm), str. serr.
2 ea.	8-42TC	Mayo-Hegar NH 5" (12.7 cm), Carb-N-Sert jaws
2 ea.	11-50	Rigid Shaft Retractor, 1 sharp prong
2 ea.	11-102	Cushing Vein Retractor
2 ea.	11-538	Volkman Retractor, ring handle, 2 blunt prongs
2 ea.	16-8	Allis Tissue Forceps 6" (15.2 cm), 5 x 6 T



Surgical Instrument Sets

GENERAL SURGERY

PEDIATRIC LAPAROTOMY SET (add Plastic Set)

Quantity	Catalog No.	Description
1 ea.	11-112	Baby Farabeuf Retractor 4¾" (12.1 cm)
1 ea.	11-144	Pediatric Ribbon Retractor ¾" (1.6 cm)
2 ea.	11-219	Pediatric Deaver Retractor ¾" (1.9 cm)
2 ea.	11-246	Richardson Retractor 1" (2.5 cm) x ¾" (1.9 cm)
1 ea.	11-430	Pediatric Balfour Retractor
6 ea.	16-4	Baby Allis Tissue Forceps 5½" (14 cm), 4 x 5 T
1 ea.	18-660	Stainless Steel Ruler

APPENDECTOMY AND HERNIA SET

Quantity	Catalog No.	Description
2 ea.	4-7	Knife Handle No. 3
2 ea.	4-8	Knife Handle No. 4
1 ea.	5-124TC	Mayo Dissecting Scissors 6¾" (17.1 cm), str. Carb-N-Sert blades
1 ea.	5-126TC	Mayo Dissecting Scissors 6¾" (17.1 cm), cvd. Carb-N-Sert blades
1 ea.	5-182TC	Metzenbaum Dissecting Scissors 7" (17.8 cm), cvd. Carb-N-Sert blades
1 ea.	6-8	Dressing Forceps 5½" (14 cm)
1 ea.	6-44	Tissue Forceps 5½" (14 cm), 1 x 2 T
1 ea.	6-118	Adson Dressing Forceps 4¾" (12.1 cm), serr.
1 ea.	6-120	Adson Tissue Forceps 4¾" (12.1 cm), 1 x 2 T
1 ea.	6-144	Russian Tissue Forceps 8" (20.3 cm)
2 ea.	7-2	Halsted Mosquito Forceps 5" (12.7 cm), str.
6 ea.	7-4	Halsted Mosquito Forceps 5" (12.7 cm), cvd.
4 ea.	7-38	Kelly Forceps 5½" (14 cm), cvd.
6 ea.	7-48	Crile Hemostatic Forceps 6¼" (15.9 cm), cvd.
6 ea.	7-154	Rochester Ochsner Forceps 8" (20.3 cm), 1 x 2 T, str.
8 ea.	7-506	Backhaus Towel Clamp 5¼" (13.3 cm)
1 ea.	7-600	Foersler Sponge Forceps 9" (22.9 cm), str. serr.
1 ea.	8-44TC	Mayo-Hegar Needle Holder 6" (15.2 cm), Carb-N-Sert jaws
1 ea.	8-46TC	Mayo-Hegar Needle Holder 7" (17.8 cm), Carb-N-Sert jaws
1 ea.	10-310	Poole Suction Tube, cvd.
1 ea.	11-122	U.S. Army Retractor, Set of 2
1 ea.	11-130	Ribbon Retractor ¾" (1.9 cm), x 13" (33 cm)
1 ea.	11-136	Ribbon Retractor 1½" (3.8 cm) x 13" (33 cm)

Cont'd on next page

GENERAL SURGERY

APPENDECTOMY AND HERNIA SET (Cont'd)

Quantity	Catalog No.	Description
2 ea.	11-247	Richardson Retractor 1½" (3.2 cm) x 1" (2.5 cm)
2 ea.	11-267	Kelly Retractor 2½" (6.4 cm) x 2" (5.1 cm)
4 ea.	16-6	Allis Tissue Forceps 6" (15.2 cm), 4 x 5 T
2 ea.	16-44	Babcock Tissue Forceps 6¼" (15.9 cm)

COMMON DUCT INSTRUMENTS (add Basic Laparotomy Set)

Quantity	Catalog No.	Description
2 ea.	7-258	Gemini-Mixer Forceps 9" (22.9 cm)
1 ea.	14-2	Ochsner (Fenger) Gall Duct Probe
1 ea.	14-8	Bakes Common Duct Dilator, Set of 9
1 ea.	14-26-L	Ferguson Gall Scoop, large
1 ea.	14-26-M	Ferguson Gall Scoop, medium
1 ea.	14-26-S	Ferguson Gall Scoop, small
2 ea.	14-49	Lahey Gall Duct Forceps 9" (22.9 cm)
1 ea.	29-284	Randall Stone Forceps, ¼ curve
1 ea.	29-286	Randall Stone Forceps, ½ curve
1 ea.	29-288	Randall Stone Forceps, ¾ curve
1 ea.	29-290	Randall Stone Forceps, full curve

BOWEL RESECTION SET (add Basic Laparotomy Set)

Quantity	Catalog No.	Description
8 ea.	7-4	Halsted Mosquito Forceps 5" (12.7 cm), cvd.
2 ea.	7-180	Rochester Carmalt Forceps 8" (20.3 cm), str.
1 ea.	16-56	Williams Tissue Forceps 6½" (16.5 cm)
2 ea.	16-100	Allen Intestinal Clamp 8" (20.3 cm)
2 ea.	16-160	Doyen Intestinal Forceps 9" (22.9 cm), str.
2 ea.	16-230	Payr Pylorus Clamp 8" (20.3 cm)
1 ea.	24-552	DeBakey Tissue Forceps 7¾" (19.7 cm)

ABDOMINOPERINEAL RESECTION SET (add Basic Laparotomy Set and Bowel Resection Set)

Quantity	Catalog No.	Description
1 ea.	5-124TC	Mayo Dissecting Scissors 6¾" (17.1 cm), str., Carb-N-Sert blades
1 ea.	5-126TC	Mayo Dissecting Scissors 6¾" (17.1 cm), cvd., Carb-N-Sert blades

Cont'd on next page



Surgical Instrument Sets

GENERAL SURGERY

ABDOMINOPERINEAL RESECTION SET (Cont'd)

Quantity	Catalog No.	Description
1 ea.	5-130TC	Mayo Dissecting Scissors 9" (22.9 cm), cvd., Carb-N-Sert blades
1 ea.	5-182TC	Metzenbaum Scissors 7" (17.8 cm), cvd., Carb-N-Sert blades
1 ea.	6-210	Mayo-Russian Tissue Forceps 9" (22.9 cm)
2 ea.	7-142	Rochester-Pean Forceps 8" (20.3 cm), cvd.
2 ea.	7-154	Rochester-Ochsner Forceps 8" (20.3 cm), str.
1 ea.	7-259	Gemini-Mixer Forceps 11" (27.9 cm)
1 ea.	8-52TC	Crile-Wood Needle Holder 8" (20.3 cm), Carb-N-Sert jaws
1 ea.	8-134TC	Wangensteen Needle Holder 10½" (26.7 cm), Carb-N-Sert jaws
1 ea.	11-350	Israel Retractor, 4 prongs
1 ea.	11-352	Israel Retractor, 6 prongs
2 ea.	11-542	Volkman Retractor, 4 prongs, blunt
4 ea.	16-6	Allis Tissue Forceps 6" (15.2 cm), 4 x 5 T

THYROIDECTOMY SET (add Plastic Set)

Quantity	Catalog No.	Description
1 ea.	5-182B-TC	Metzenbaum Scissors 7" (17.8 cm), cvd., sharp points, Carb-N-Sert blades
1 ea.	5-182TC	Metzenbaum Scissors 7" (17.8 cm), cvd., Carb-N-Sert blades
2 ea.	7-98	Lovelace Forceps 6¼" (15.9 cm), str., 1 x 2 T
1 ea.	11-20	Lahey Retractor
1 ea.	11-22	Green Retractor 8½" (21.6 cm)
1 ea.	11-23	Little Retractor 7¾" (19.7 cm)
1 ea.	11-102	Cushing Vein Retractor 9" (22.9 cm)
6 ea.	12-80	Lahey Traction Forceps 6¼" (15.9 cm)

GENITO-URINARY SURGERY

NEPHRECTOMY SET

Quantity	Catalog No.	Description
2 ea.	5-182A-TC	Metzenbaum Scissors 7" (17.8 cm), delicate, Carb-N-Sert blades
2 ea.	7-206	Mixer Gallbladder Forceps 9" (22.9 cm)
6 ea.	7-252	Mosquito Forceps 8 1/4" (21 cm), cvd.
2 ea.	7-258	Gemini Mixer Forceps 9" (22.9 cm)
4 ea.	7-259	Gemini Mixer Forceps 11" (27.9 cm)
1 ea.	7-622	Bozeman Sponge Forceps 10 1/2" (26.7 cm), double curve
1 ea.	8-100TC	Heaney Needle Holder 8 1/4" (21.6 cm), Carb-N-Sert jaws
1 ea.	8-114TC	Sarot Needle Holder 10 1/2" (26.7 cm), Carb-N-Sert jaws
1 ea.	10-26-ST	Probe w/eye 5 1/2" (14 cm), sterling
1 ea.	10-82	Grooved Director 5 1/2" (14 cm), w/probe tip
2 ea.	11-102	Cushing Vein Retractor
1 ea.	13-68	Ochsner Trocar, impr. patt., 20 Fr. (6.6 mm)
1 ea.	14-56	Grey Cystic Duct Forceps 9" (22.9 cm), Set of 2
2 ea.	16-48	Babcock Tissue Forceps 9 1/4" (23.5 cm)
1 ea.	21-180	Love Nerve Retractor, str.
2 ea.	24-2110	Satinsky-DeBakey Forceps 9 1/2" (24.1 cm)
1 ea.	26-1352	Love Nerve Retractor, 45° angle
1 ea.	29-284	Randall Stone Forceps, 1/4 cvd.
1 ea.	29-286	Randall Stone Forceps, 1/2 cvd.
1 ea.	29-288	Randall Stone Forceps, 3/4 cvd.
1 ea.	29-290	Randall Stone Forceps, full cvd.
2 ea.	29-304	Herrick Pedicle Clamp 9 1/2" (24.1 cm)
2 ea.	29-308	Mayo Guyon Vessel Clamp 9 1/4" (23.5 cm)

PYELOPLASTY AND URETEROPLASTY SET (add Basic Laparotomy Set and Nephrectomy Set)

Quantity	Catalog No.	Description
1 ea.	5-300	Iris Scissors 4" (10.2 cm)
1 ea.	6-118	Adson Dressing Forceps 4 3/4" (12.1 cm), serr.
2 ea.	6-124	Brown-Adson Tissue Forceps 4 3/4" (12.1 cm), 7 x 7 T
12 ea.	7-10	Halsted Mosquito Forceps 5" (12.7 cm), cvd. delicate
1 ea.	8-7A-TC	Webster Needle Holder 4 3/4" (12.1 cm), Carb-N-Sert jaws
1 ea.	14-27	Mayo Common Duct Scoop, small
1 ea.	14-28	Mayo Common Duct Scoop, medium
1 ea.	18-660	Stainless Steel Ruler
1 ea.	19-574	Frazier Ferguson Suction Tube 9 Fr. (3 mm)



Surgical Instrument Sets

GENITO-URINARY SURGERY

SUPRAPUBIC AND RETROPUBIC PROSTATECTOMY SET (add Basic Laparotomy Set)

Quantity	Catalog No.	Description
1 ea.	5-128TC	Mayo Dissecting Scissors 9" (22.9 cm), str., Carb-N-Sert blades
1 ea.	5-130TC	Mayo Dissecting Scissors 9" (22.9 cm), cvd., Carb-N-Sert blades
6 ea.	7-142	Rochester-Pean Forceps 8" (20.3 cm), cvd.
2 ea.	11-247	Richardson Retractor 1¼" (3.2 cm) x 1" (2.5 cm)
2 ea.	11-266	Kelly Retractor 2" (5.1 cm) x 1½" (3.8 cm)
1 ea.	11-392	Masson-Judd Bladder Retractor, with center blade
1 ea.	29-2	Van Buren Sounds, Set of 6
1 ea.	29-310TC	Bihrlre-Dorsal Clamp/Needle Holder, 11" (27.9 cm), Carb-N-Sert jaws

VASECTOMY — MEATOTOMY SET

Quantity	Catalog No.	Description
1 ea.	4-7	Knife Handle No. 3
1 ea.	5-304	Iris Scissors 4½" (11.4 cm), str.
1 ea.	5-306	Iris Scissors 4½" (11.4 cm), cvd.
1 ea.	5-180TC	Metzenbaum Scissors 7" (17.8 cm), cvd., Carb-N-Sert blades
1 ea.	6-118	Adson Dressing Forceps 4¾" (12.1 cm), serr.
1 ea.	6-120	Adson Tissue Forceps 4¾" (12.1 cm), 1 x 2 T
2 ea.	7-2	Halsted Mosquito Forceps 5" (12.7 cm), str.
2 ea.	7-4	Halsted Mosquito Forceps 5" (12.7 cm), cvd.
4 ea.	7-504	Backhaus Towel Clamp 3½" (8.9 cm)
1 ea.	8-42TC	Mayo-Hegar Needle Holder 5" (12.7 cm), Carb-N-Sert jaws
1 ea.	16-3	Baby Allis Tissue Forceps 5" (12.7 cm)

TUBOPLASTY SET (add Basic Laparotomy Set)

Quantity	Catalog No.	Description
1 ea.	4-9	Knife Handle No. 7
1 ea.	5-300	Iris Scissors 4" (10.2 cm), str.
1 ea.	5-302	Iris Scissors 4" (10.2 cm), cvd.
1 ea.	6-124	Brown-Adson Tissue Forceps 4¾" (12.1 cm), 7 x 7 T
1 ea.	6-154	Potts Smith Dressing Forceps 7" (17.8 cm), serr.
4 ea.	7-10	Halsted Mosquito Forceps 5" (12.7 cm), delicate, cvd.
1 ea.	8-7A-TC	Webster Needle Holder 4¾" (12.1 cm), Carb-N-Sert jaws
1 ea.	10-26-ST	Probe w/eye 5½" (14 cm), sterling
1 ea.	17-303C	Swiss Jewelers Style Forceps No. 3C

Cont'd on next page

Surgical Instrument Sets



GENITO-URINARY SURGERY

TUBOPLASTY SET (Cont'd)

Quantity	Catalog No.	Description
2 ea.	18-416	Guthrie Hook, double prongs
1 ea.	18-740 to 18-750	Bowman Sterling Probes, Set of 6
1 ea.	18-950	Castroviejo Suturing Forceps
1 ea.	18-1625	McPherson-Vannas (Iris) Scissors 3/4" (8.3 cm), str.
1 ea.	18-1831	Castroviejo Needle Holder, w/lock, delicate
1 ea.	20-460	Frazier Ferguson Suction Tube, str. 9 Fr. (3 mm)
2 ea.	21-152	Miltex Skin Hook, 2 mm



Surgical Instrument Sets

RECTAL SURGERY

RECTAL INSTRUMENT SET

Quantity	Catalog No.	Description
1 ea.	5-16	Operating Scissors 5½" (14 cm), str. S/B
1 ea.	5-122TC	Mayo Operating Scissors 5½" (14 cm), cvd., Carb-N-Sert blades
1 ea.	5-124TC	Mayo Dissecting Scissors 6¾" (17.1 cm), str., Carb-N-Sert blades
1 ea.	5-126TC	Mayo Dissecting Scissors 6¾" (17.1 cm), cvd., Carb-N-Sert blades
1 ea.	6-10	Dressing Forceps 6" (15.2 cm)
4 ea.	7-46	Crile Forceps 6¼" (15.9 cm), str.
2 ea.	7-138	Rochester-Pean Forceps 6¼" (15.9 cm), cvd.
4 ea.	7-220	Pennington Forceps 6" (15.2 cm)
6 ea.	7-506	Backhaus Towel Clamp 5¼" (13.3 cm)
1 ea.	8-46TC	Mayo-Hegar Needle Holder 7" (17.8 cm), Carb-N-Sert jaws
2 ea.	11-553	Volkman Retractor, 4 prong, sharp
1 ea.	16-10	Allis Tissue Forceps, 7¼" (18.4 cm), 5 x 6 T
1 ea.	28-2	Sims Rectal Speculum
1 ea.	28-20	Hirschman Anoscope, small
1 ea.	28-22	Hirschman Anoscope, medium
1 ea.	28-24	Hirschman Anoscope, large
1 ea.	28-70	Sawyer Rectal Retractor 7/8" (2.2 cm) x 2½" (6.4 cm)
1 ea.	28-74	Sawyer Rectal Retractor 1½" (3.8 cm) x 3½" (8.9 cm)
1 ea.	28-100	Larry Probe and Grooved Director 7" (17.8 cm)
1 ea.	28-108	Pratt Rectal Probe 7¾" (19.7 cm) shaft
1 ea.	28-131	Rosser Crypt Hook 6¾" (17.1 cm)
1 ea.	28-370	Buie Suction Tube 15 Fr. (5 mm)
1 ea.	28-386	Milltex Rotating Biopsy Forceps 14" (35.6 cm)

PILONIDAL CYST EXCISION SET (add Rectal Instrument Set)

Quantity	Catalog No.	Description
1 ea.	10-28-ST	Probe w/eye 6" (15.2 cm), sterling
1 ea.	11-553	Volkman Retractor 4 prong, blunt
1 ea.	19-714	Spratt Brun Curette 6½" (16.5 cm), oval, size 3

Cont'd on next page

Surgical Instrument Sets



RECTAL SURGERY

HEMORRHOIDECTOMY SET

Quantity	Catalog No.	Description
2 ea.	4-7	Knife Handle No. 3
1 ea.	5-180TC	Metzenbaum Scissors 5½" (14 cm), cvd., Carb-N-Sert blades
1 ea.	6-8	Dressing Forceps 5½" (14 cm)
1 ea.	6-44	Tissue Forceps 5½" (14 cm), 1 x 2 T
4 ea.	7-2	Halsted Mosquito Forceps 5" (12.7 cm), str.
6 ea.	7-506	Backhaus Towel Clamp 5½" (14 cm)
1 ea.	7-600	Foerster Sponge Forceps 9½" (24.1 cm), str. serr.
2 ea.	16-6	Allis Tissue Forceps 6" (15.2 cm), 4 x 5 T
1 ea.	28-22	Hirschman Anoscope, medium
1 ea.	28-32	Brinkerhoff Rectal Speculum, medium
1 ea.	28-70	Sawyer Rectal Retractor ¾" (2.2 cm) x 2½" (6.4 cm)
1 ea.	28-74	Sawyer Rectal Retractor 1½" (3.8 cm) x 3½" (8.9 cm)

FOR OFFICE PROCEDURE:

1 ea.	28-150	McGivney Hemorrhoidal Ligator. Supplied with loading cone and 100 latex O-rings
1 ea.	28-152	McGivney Hemorrhoid Grasping Forceps 7" (19.1 cm)
1 ea.	28-12	Fansler-Ives Rectal Speculum 3¼" (8.3 cm) long x 1⅞" (2.8 cm), chrome



Surgical Instrument Sets

OBSTETRICAL AND GYNECOLOGICAL SURGERY

DILATATION AND CURETTAGE SET

Quantity	Catalog No.	Description
1 ea.	4-7	Knife Handle No. 3
1 ea.	4-11	Knife Handle No. 4L
1 ea.	6-14	Dressing Forceps 8" (20.3 cm)
1 ea.	6-128	Heaney Tissue Forceps 5½" (14 cm), 2 x 3 T
4 ea.	7-506	Backhaus Towel Clamp 5¼" (13.3 cm)
1 ea.	7-600	Foerster Sponge Forceps 9½" (24.1 cm), str. serr.
1 ea.	7-622	Bozeman Dressing Forceps 10½" (26.7 cm), double cvd.
1 ea.	8-100TC	Heaney Needle Holder 8" (20.3 cm), Carb-N-Sert jaws
1 ea.	30-15	Graves Vaginal Speculum, medium size
1 ea.	30-193	Auvard Weighted Speculum 2½ lbs. (1136 g)
1 ea.	30-300	Jackson Vaginal Retractor, 1½" (3.8 cm) x 3" (7.6 cm)
1 ea.	30-305	Jackson Vaginal Retractor, 1½" (3.8 cm) x 3½" (8.9 cm)
1 ea.	30-310	Jackson Vaginal Retractor, 1½" (3.8 cm) x 4" (10.2 cm)
1 ea.	30-550	Hegar Uterine Dilators, Set of 8
1 ea.	30-650	Sims Uterine Sound
1 ea.	30-965	Schroeder Braun Tenaculum Forceps 9¾" (24.8 cm), str.
1 ea.	30-1025	Jacobs Vulsellum Forceps 8½" (21.6 cm), str.
1 ea.	30-1205-1	Sims Uterine Curette, sharp, size 1
1 ea.	30-1205-3	Sims Uterine Curette, sharp, size 3
1 ea.	30-1205-5	Sims Uterine Curette, sharp, size 5
1 ea.	30-1380	Sims Uterine Biopsy Curette

BASIC VAGINAL INSTRUMENT SET

Quantity	Catalog No.	Description
1 ea.	4-7	Knife Handle No. 3
1 ea.	4-11	Knife Handle No. 4L
1 ea.	5-16	Operating Scissors 5½" (14 cm), str. S/B
1 ea.	5-124TC	Mayo Dissecting Scissors 6¾" (17.1 cm), str. Carb-N-Sert blades
1 ea.	5-126TC	Mayo Dissecting Scissors 6¾" (17.1 cm), cvd. Carb-N-Sert blades
1 ea.	5-182TC	Metzenbaum Scissors 7" (17.8 cm), cvd. Carb-N-Sert blades
1 ea.	6-8	Dressing Forceps 5½" (14 cm)
1 ea.	6-14	Dressing Forceps 8" (20.3 cm)
1 ea.	6-44	Tissue Forceps 5½" (14 cm), 1 x 2 T
1 ea.	6-4B	Tissue Forceps 8" (20.3 cm), 1 x 2 T

Cont'd on next page

Surgical Instrument Sets



OBSTETRICAL AND GYNECOLOGICAL SURGERY

BASIC VAGINAL INSTRUMENT SET (Cont'd)

Quantity	Catalog No.	Description
4 ea.	7-36	Kelly Forceps 5½" (14 cm), str.
4 ea.	7-38	Kelly Forceps 5½" (14 cm), cvd.
4 ea.	7-138	Rochester-Pean Forceps 6¼" (15.9 cm), cvd.
2 ea.	7-150	Rochester-Ochsner Forceps 6¼" (15.9 cm), str.
8 ea.	7-506	Backhaus Towel Clamp 5¼" (13.3 cm)
1 ea.	7-600	Foerster Sponge Forceps 9½" (24.1 cm), str. serr.
1 ea.	7-622	Bozeman Dressing Forceps 10½" (26.7 cm), double curved
1 ea.	11-116	Parker Retractor, Set of 2
1 ea.	11-200	Deaver Retractor 1" (2.5 cm) x 9" (22.9 cm)
2 ea.	16-10	Allis Tissue Forceps 7¼" (18.4 cm), 5 x 6 T
1 ea.	30-193	Auvarud Weighted Speculum, 2½ lbs. (1136 g)
1 ea.	30-215	Sims Retractor, medium
2 ea.	30-965	Schroeder-Braun Tenaculum Forceps 9½" (24.1 cm)
1 ea.	30-1020	Skene Vulsellum Forceps 9½" (24.1 cm), str.

ABDOMINAL GYNECOLOGICAL SET (add Basic Laparotomy Set)

Quantity	Catalog No.	Description
1 ea.	4-11	Knife Handle No. 4L
1 ea.	5-130TC	Mayo Dissecting Scissors 9" (22.9 cm), cvd., Carb-N-Sert blades
1 ea.	6-52	Tissue Forceps 12" (30.5 cm), 1 x 2 T
1 ea.	6-128	Heaney Tissue Forceps, 2 x 3 T
2 ea.	7-124	Rochester-Ochsner Forceps 8" (20.3 cm), str.
1 ea.	7-600	Foerster Sponge Forceps 9" (22.9 cm), str. serr.
2 ea.	8-100TC	Heaney Needle Holder 8" (20.3 cm), curved, Carb-N-Sert jaws
1 ea.	11-410	O'Sullivan - O'Connor Retractor
2 ea.	16-10	Allis Tissue Forceps 7¼" (18.4 cm), 5 x 6 T
1 ea.	30-15	Graves Vaginal Speculum, medium
2 ea.	30-965	Schroeder-Braun Tenaculum Forceps
1 ea.	30-1010	Schroeder Vulsellum Forceps, cvd. sideways
1 ea.	30-1025	Jacobs Vulsellum Forceps, str.
1 ea.	30-1710	Heaney Hysterectomy Forceps 8¼" (21 cm), double tooth
1 ea.	30-1716	Heaney-Ballantine Hysterectomy Forceps, cvd.



Surgical Instrument Sets

OBSTETRICAL AND GYNECOLOGICAL SURGERY

LAPAROSCOPY SET

Quantity	Catalog No.	Description
1 ea.	4-7	Knife Handle No. 3
1 ea.	5-124TC	Mayo Dissecting Scissors 6¾" (17.1 cm), str. Carb-N-Sert blades
1 ea.	6-120	Adson Tissue Forceps 4¾" (12.1 cm), 1 x 2 T
2 ea.	7-91	Coller Forceps 6¼" (15.9 cm), cvd.
6 ea.	7-506	Backhaus Towel Clamp 5¼" (13.3 cm)
1 ea.	7-600	Foerster Sponge Forceps 9" (22.9 cm), str. serr.
1 ea.	8-51TC	Crile-Wood Needle Holder 7" (17.8 cm), Carb-N-Sert jaws
1 ea.	11-185	Heaney-Simon Retractor
2 ea.	16-6	Allis Tissue Forceps 6" (15.2 cm), 4 x 5 T
1 ea.	30-15	Graves Vaginal Speculum, medium
1 ea.	30-193	Auvar Weighted Speculum 2½ lbs. (1136 g)
1 ea.	30-650	Sims Uterine Sound, grad. in cm
1 ea.	30-965	Schroeder-Braun Tenaculum Forceps 9¾" (24.8 cm)

BARTHOLIN CYST EXCISION SET

Quantity	Catalog No.	Description
1 ea.	4-7	Knife Handle No. 3
1 ea.	5-124TC	Mayo Dissecting Scissors 6¾" (17.1 cm), str., Carb-N-Sert blades
1 ea.	5-126TC	Mayo Dissecting Scissors 6¾" (17.1 cm), cvd., Carb-N-Sert blades
1 ea.	5-182TC	Metzenbaum Scissors 7" (17.8 cm), cvd., Carb-N-Sert blades
1 ea.	6-8	Dressing Forceps 5½" (14 cm)
1 ea.	6-44	Tissue Forceps 5½" (14 cm), 1 x 2 T
2 ea.	7-4	Halstead Mosquito Forceps 5" (12.7 cm), cvd.
2 ea.	7-138	Rochester Pean Forceps 6¼" (15.9 cm), cvd.
6 ea.	7-506	Backhaus Towel Clamp 5¼" (13.3 cm)
1 ea.	7-600	Foerster Sponge Forceps 9½" (24.1 cm), str. serr.
1 ea.	8-46TC	Mayo Hegar Needle Holder 7" (17.8 cm), Carb-N-Sert jaws
2 ea.	16-10	Allis Tissue Forceps 7½" (19.1 cm), 5 x 6 T
1 ea.	30-193	Auvar Weighted Speculum, 2½ lbs. (1136 g)
1 ea.	30-215	Sims Vaginal Speculum, double end, medium

OBSTETRICAL AND GYNECOLOGICAL SURGERY

VAGINAL TUBAL LIGATION SET

Quantity	Catalog No.	Description
1 ea.	4-7	Knife Handle No. 3
1 ea.	4-11	Knife Handle No. 4L
1 ea.	5-124TC	Mayo Dissecting Scissors 6¾" (17.1 cm), str. Carb-N-Sert blades
1 ea.	5-182TC	Metzenbaum Scissors 7" (17.8 cm), cvd. Carb-N-Sert blades
1 ea.	6-44	Tissue Forceps 5½" (14 cm), 1 x 2 T
1 ea.	6-145	Russian Tissue Forceps 10" (25.4 cm)
6 ea.	7-38	Kelly Forceps 5½" (14 cm), cvd.
2 ea.	7-142	Rochester-Pean Forceps 8" (20.3 cm), cvd.
2 ea.	7-259	Gemini-Mixer Forceps 11" (27.9 cm)
6 ea.	7-506	Backhaus Towel Clamp 5¼" (13.3 cm)
1 ea.	7-600	Foerster Sponge Forceps 9½" (24.1 cm), str. serr.
1 ea.	8-100TC	Heaney Needle Holder 8" (20.3 cm), cvd., Carb-N-Sert jaws
1 ea.	11-185	Heaney-Simon Retractor 11½" (29.2 cm)
1 ea.	11-202	Deaver Retractor 1" (2.5 cm) x 12" (30.5 cm)
4 ea.	16-6	Allis Tissue Forceps 6" (15.2 cm), 4 x 5 T
2 ea.	16-10	Allis Tissue Forceps 7¼" (18.4 cm), 5 x 6 T
2 ea.	16-46	Babcock Tissue Forceps 8¼" (21 cm)
1 ea.	30-15	Graves Vaginal Speculum, medium
1 ea.	30-193	Auvard Weighted Speculum, 2½ lbs. (1136 g)
1 ea.	30-650	Sims Uterine Sound, grad. in cm
2 ea.	30-965	Schroeder-Braun Tenaculum Forceps 9½" (24.1 cm), str.
2 ea.	30-1710	Heaney Hysterectomy Forceps 8¼" (21 cm), double tooth



Surgical Instrument Sets

NEUROSURGERY

BASIC CRANIOTOMY SET

Quantity	Catalog No.	Description
1 ea.	4-7	Knife Handle No. 3
1 ea.	5-120TC	Mayo Dissecting Scissors 5½" (14 cm), str., Carb-N-Sert blades
1 ea.	5-122TC	Mayo Dissecting Scissors 5½" (14 cm), cvd., Carb-N-Sert blades
1 ea.	5-182TC	Metzenbaum Scissors 7" (17.8 cm), cvd., Carb-N-Sert blades
1 ea.	5-246	Potts-Smith Scissors 7½" (19.1 cm), 25° angle
1 ea.	5-250	Adson Scissors 6¼" (15.9 cm), str., sharp points
1 ea.	6-109A	Semkin Tissue Forceps 6" (15.2 cm), 1 x 2 T
1 ea.	6-118	Adson Dressing Forceps 4¾" (12.1 cm)
1 ea.	6-120	Adson Tissue Forceps 4¾" (12.1 cm), 1 x 2 T
1 ea.	6-168	Cushing Tissue Forceps 7" (17.8 cm), 1 x 2 T
1 ea.	6-198	Adson Bayonet Forceps 8¼" (21 cm), serr.
6 ea.	7-8	Halsted Mosquito Forceps 5" (12.7 cm), str., delicate
6 ea.	7-10	Halsted Mosquito Forceps 5" (12.7 cm), cvd., delicate
12 ea.	7-102	Dandy Scalp Hemostat 5½" (14 cm)
2 ea.	7-120	Rochester-Ochsner Forceps 6¼" (15.9 cm), str.
2 ea.	7-122	Rochester-Ochsner Forceps 7¼" (18.4 cm), str.
2 ea.	7-240	Adson Hemostatic Forceps 7¼" (18.4 cm), str.
2 ea.	7-242	Adson Hemostatic Forceps 7¼" (18.4 cm), cvd.
8 ea.	7-504	Backhaus Towel Clamp 3½" (8.9 cm)
8 ea.	7-506	Backhaus Towel Clamp 5¼" (13.3 cm)
1 ea.	7-600	Foerster Sponge Forceps 9½" (24.1 cm), str., serr.
1 ea.	8-50TC	Crile-Wood Needle Holder 6" (15.2 cm), Carb-N-Sert jaws
1 ea.	8-51TC	Crile-Wood Needle Holder 7" (17.8 cm), Carb-N-Sert jaws
	9-2	Michel Wound Clips - 11 mm, one rack w/25 clips
1 ea.	9-124	Wire Cutting Scissors 4¾" (12.1 cm), angular
1 ea.	11-2	Jansen Retractor 4¼" (10.8 cm), blunt
1 ea.	11-8	Jansen-Wagner Retractor 5" (12.7 cm), sharp
2 ea.	11-74	Senn Retractor 6¾" (16.2 cm), double end, sharp
2 ea.	11-564	Murphy Retractor 7½" (19.1 cm), 4 prong, sharp
1 ea.	11-684	Beckman Retractor 12½" (31.8 cm), sharp
1 ea.	11-700	Adson Retractor 7½" (19.1 cm), sharp
2 ea.	16-6	Allis Tissue Forceps 6" (15.2 cm)
1 ea.	18-1968	Freer Elevator 7" (17.8 cm), double end
1 ea.	19-572	Frazier Ferguson Suction Tube, 7 Fr. (2.3 mm)

Cont'd on next page

NEUROSURGERY

BASIC CRANIOTOMY SET (Cont'd)

Quantity	Catalog No.	Description
1 ea.	19-574	Frazier Ferguson Suction Tube, 9 Fr. (3 mm)
1 ea.	19-840	Zaufel-Jansen Rongeur 7" (17.8 cm)
1 ea.	21-180	Love Nerve Retractor 8½" (21.6 cm), str.
1 ea.	25-458	Stille-Luer Rongeur 9" (22.9 cm), angled
1 ea.	26-2	Cushing Perforator Drill
1 ea.	26-24	Cerebellar Extension
1 ea.	26-32	Hudson Brace
1 pr.	26-124	Gigli-Strully Saw Handle, Set of 2
2 ea.	26-132	Gigli Saw 20" (50.8 cm)
1 ea.	26-138	Bailey Gigli Saw Guide 12" (30.5 cm)
1 ea.	26-190	Luer Rongeur 7" (17.8 cm), str.
1 ea.	26-326	Schlesinger Cervical Rongeur 6" (15.2 cm), 3 mm upwards bite
1 ea.	26-389	Miltex-Kerrison Cervical Rongeur 7" (17.8 cm), 3 mm bite, 40° forward
1 ea.	26-397	Cushing Pituitary Rongeur
1 ea.	26-700	Scoville Brain Spatula 8" (20.3 cm)
1 ea.	26-730	Cushing Spatula Spoon 6¾" (17.1 cm)
1 ea.	26-1054	Frazier Dura Separator 6½" (16.5 cm)
2 ea.	26-1084	Frazier Dura Hook 5" (12.7 cm), sharp
1 ea.	26-1090	Adson Dura Hook 8" (20.3 cm)
1 ea.	26-1150	Dandy Nerve Hook 9" (22.9 cm), str.
1 ea.	26-1352	Love Nerve Retractor 8½" (21.6 cm), angled 45°
1 ea.	26-1354	Love Nerve Retractor 8½" (21.6 cm), angled 90°
1 ea.	26-1403	Cushing Little Joker Periosteal Elevator 6" (15.2 cm)
1 ea.	26-1412	Langenbeck Periosteal Elevator 7½" (19.1 cm)
1 ea.	26-1432	Adson Periosteal Elevator 6½" (16.5 cm), blunt

VENTRICULOGRAPHY SET

Quantity	Catalog No.	Description
2 ea.	4-7	Knife Handle No. 3
1 ea.	5-124TC	Mayo Dissecting Scissors 6¾" (17.1 cm), str. Carb-N-Sert blades
1 ea.	5-126TC	Mayo Dissecting Scissors 6¾" (17.1 cm), cvd. Carb-N-Sert blades
1 ea.	5-182A-TC	Metzenbaum Scissors 7" (17.8 cm), cvd., delicate, Carb-N-Sert blades
1 ea.	5-250	Kelly Scissors 6¼" (15.9 cm), str., sharp points

Cont'd on next page



Surgical Instrument Sets

NEUROSURGERY

VENTRICULOGRAPHY SET (Cont'd)

Quantity	Catalog No.	Description
1 ea.	6-109A	Semkin Tissue Forceps 6" (15.2 cm), 1 x 2 T
1 ea.	6-186	Cushing Tissue Forceps 7" (17.8 cm), 1 x 2 T
1 ea.	6-190	Cushing Bayonet Forceps 7¼" (18.4 cm), serrated
6 ea.	7-102	Dandy Scalp Hemostat 5½" (14 cm)
4 ea.	7-506	Backhaus Towel Clamp 5¼" (13.3 cm)
1 ea.	7-600	Foerster Sponge Forceps 9½" (24.1 cm), str., serr.
1 ea.	8-51TC	Crile-Wood Needle Holder 7" (17.8 cm), Carb-N-Sert jaws
1 ea.	11-2	Jansen Retractor 4¼" (10.8 cm), blunt
1 ea.	11-8	Jansen-Wagner Retractor 5" (12.7 cm), sharp
1 ea.	11-74	Senn Retractor 6¾" (16.2 cm), double end, sharp
1 ea.	19-574	Frazier Ferguson Suction Tube 9 Fr. (3 mm)
1 ea.	19-704	Spratt Curette 6½" (16.5 cm), size 3/0
1 ea.	19-708	Spratt Curette 6½" (16.5 cm), size 0
1 ea.	26-2	Cushing Perforator Drill
1 ea.	26-24	Cerebellar Extension
1 ea.	26-32	Hudson Brace
1 ea.	26-772	Elsberg Cannula 7 Fr. (2.3 mm)
1 ea.	26-778	Frazier Needle 9 Fr. (3 mm)
1 ea.	26-1084	Frazier Dura Hook 5" (12.7 cm), sharp
1 ea.	26-1403	Cushing Little Joker Elevator 6" (15.2 cm)
1 ea.	26-1434	Adson Periosteal Elevator 6½" (16.5 cm), cvd.

NEUROSURGICAL-LAMINECTOMY SET (add Basic Orthopedic Soft Tissue Set)

Quantity	Catalog No.	Description
1 ea.	5-247	Potts-Smith Scissors 7" (17.8 cm), 45° angle
1 ea.	5-262	Strully Scissors 8" (20.3 cm), with probe tips
1 ea.	6-118	Adson Dressing Forceps 4¾" (12.1 cm), serr.
1 ea.	6-120	Adson Tissue Forceps 4¾" (12.1 cm), 1 x 2 T
1 ea.	6-190	Cushing Dressing Forceps 7¼" (18.4 cm), bayonet, serr.
1 ea.	6-192	Cushing Tissue Forceps 7¼" (18.4 cm), bayonet, 1 x 2 T
4 ea.	7-240	Adson Hemostatic Forceps 7¼" (18.4 cm), str.
4 ea.	7-242	Adson Hemostatic Forceps 7¼" (18.4 cm), cvd.
1 ea.	7-600	Foerster Sponge Forceps 9" (22.9 cm), str. serr.
1 ea.	8-82TC	Julian Needle Holder 8¼" (21 cm), Carb-N-Sert jaws

Cont'd on next page

NEUROSURGERY

NEUROSURGICAL-LAMINECTOMY SET (Cont'd)

Quantity	Catalog No.	Description
1 ea.	11-366	Gelpi Retractor 6¾" (17.1 cm)
1 ea.	11-684	Beckman-Adson Retractor 12½" (31.8 cm), blade ¾" (1.9 cm) deep
1 ea.	19-702	Spratt Bone Curette 6½" (16.5 cm), size 4/0
1 ea.	19-706	Spratt Bone Curette 6½" (16.5 cm), size 2/0
1 ea.	19-708	Spratt Bone Curette 6½" (16.5 cm), size 0
1 ea.	20-180	Love Nerve Retractor 8½" (21.6 cm), str.
2 ea.	24-550	DeBaakey Tissue Forceps 6" (15.2 cm)
1 ea.	26-24	Hudson Cerebellar Attachment
1 ea.	26-30	Hudson Brace Set, with 4 burs
1 ea.	26-91	Taylor Spinal Retractor 7¼" (18.4 cm)
1 ea.	26-388	Miltex-Kerrison Rongeur 7" (17.8 cm), 2 mm 40° forward angle
1 ea.	26-389	Miltex-Kerrison Rongeur 7" (17.8 cm), 3 mm 40° forward angle
1 ea.	26-390	Miltex-Kerrison Rongeur 7" (17.8 cm), 5 mm 40° forward angle
1 ea.	26-392A	Miltex-Kerrison Rongeur 7" (17.8 cm), 2 mm up-bite
1 ea.	26-393A	Miltex-Kerrison Rongeur 7" (17.8 cm), 2 mm down-bite
1 ea.	26-400	Love-Gruenwald Rongeur 5" (12.7 cm), str., 3 x 10 mm
1 ea.	26-410	Love-Gruenwald Rongeur 5" (12.7 cm), curved up, 3 x 10 mm
1 ea.	26-422	Love-Gruenwald Rongeur 7" (17.8 cm), curved down, 3 x 10 mm
1 ea.	26-660	Adson Aneurysm Needle 9" (22.9 cm)
1 ea.	26-730	Cushing Spatula Spoon 6¾" (17.1 cm)
1 ea.	26-1150	Dandy Nerve Hook 9" (22.9 cm), str.
1 ea.	26-1174	Smithwick Hook and Dissector 12" (30.5 cm), double end
1 ea.	26-1360	Scoville Nerve Root Retractor 9" (22.4 cm), str.
1 ea.	26-1362	Scoville Nerve Root Retractor 9" (22.9 cm), angular
1 ea.	26-1434	Adson Periosteal Elevator, cvd., semi-sharp
1 ea.	26-1451	Penfield Dissector, style 2, double end
1 ea.	26-1973	Beckman-Eaton Retractor 12¾" (32.4 cm), blade 2" (5.1 cm) deep
1 ea.	27-331	Hoke Osteotome 5½" (14 cm), ⅛" (.32 cm)
1 ea.	27-333	Hoke Osteotome 5½" (14 cm), ¼" (.64 cm)
1 ea.	27-335	Hoke Osteotome 5½" (14 cm), ⅜" (.95 cm)
1 ea.	27-336	Hoke Osteotome 5½" (14 cm), ½" (1.3 cm)



Surgical Instrument Sets

NEUROSURGERY

SKULL TRACTION SET

Quantity	Catalog No.	Description
1 ea.	5-140	Mayo Dissecting Scissors 6¾" (17.1 cm), str.
1 ea.	6-96	Tissue Forceps 6" (15.2 cm), delicate, 1 x 2 T
2 ea.	7-2	Halsted Mosquito Forceps 5" (12.7 cm), straight
2 ea.	7-4	Halsted Mosquito Forceps 5" (12.7 cm), curved
8 ea.	7-504	Backhaus Towel Clamp 3½" (8.9 cm)
1 ea.	7-600	Foerster Sponge Forceps 9" (22.9 cm), str. serr.
1 ea.	26-40	Stille Pattern Cranial Drill Set, w/set of drill points
1 ea.	26-60	Raney-Crutchfield Skull Tracing Tong w/2 points

Surgical Instrument Sets



ORTHOPEDIC SURGERY

BASIC MAJOR ORTHOPEDIC SET

Quantity	Catalog No.	Description
1 ea.	4-7	Knife Handle No. 3
2 ea.	4-8	Knife Handle No. 4
1 ea.	5-120TC	Mayo Dissecting Scissors 5½" (14 cm), str., Carb-N-Sert blades
1 ea.	5-122TC	Mayo Dissecting Scissors 5½" (14 cm), cvd., Carb-N-Sert blades
1 ea.	5-124TC	Mayo Dissecting Scissors 6¾" (17.1 cm), str., Carb-N-Sert blades
1 ea.	5-126TC	Mayo Dissecting Scissors 6¾" (17.1 cm), cvd., Carb-N-Sert blades
1 ea.	5-182TC	Metzenbaum Scissors 7" (17.8 cm), cvd., Carb-N-Sert blades
1 ea.	5-568	Esmarch Bandage and Cast Shears 8" (20.3 cm)
1 ea.	6-46	Tissue Forceps 6" (15.2 cm), 1 x 2 T
1 ea.	6-86	Tissue Forceps 6" (15.2 cm), 4 x 5 T
2 ea.	6-120	Adson Tissue Forceps 4¾" (12.1 cm), 1 x 2 T
6 ea.	7-48	Crile Forceps 6¼" (15.9 cm), cvd.
4 ea.	7-154	Rochester-Ochsner Forceps 8" (20.3 cm), str.
6 ea.	7-506	Backhaus Towel Clamp 5¼" (13.3 cm)
1 ea.	8-48TC	Mayo-Hegar Needle Holder 8" (20.3 cm), Carb-N-Sert jaws
1 ea.	8-50TC	Crile Wood Needle Holder 6" (15.2 cm), Carb-N-Sert jaws
1 ea.	11-122	U.S. Army Retractor 8½" (21.6 cm), set of 2
1 ea.	11-240	Meyerdig Retractor 9½" (24.1 cm), 3½" (8.9 cm) x 2" (5.1 cm)
1 ea.	11-244	Meyerdig Retractor 9½" (24.1 cm), 2" (5.1 cm) x ¾" (1.6 cm)
1 ea.	11-350	Israel Retractor 9" (22.9 cm), 4 prong, blunt
1 ea.	11-548	Volkman Retractor 8¾" (22.2 cm), 4 prong, sharp
2 ea.	11-553	Volkman Retractor 8" (20.3 cm) x ¾" (1.9 cm), 4 prong, blunt
1 ea.	11-580	Bennett Bone Elevator 9½" (24.1 cm), small
1 ea.	11-582	Bennett Bone Elevator 9½" (24.1 cm), large
1 ea.	11-590	Hibbs Retractor 9¼" (23.5 cm)
1 ea.	11-684	Beckman Retractor 12" (30.5 cm), hinged blades
6 ea.	16-6	Allis Tissue Forceps 6" (15.2 cm), 4 x 5 T
1 ea.	18-660	Stainless Steel Ruler 6" (15.2 cm)
1 ea.	19-573	Frazier Ferguson Suction Tube 8 Fr. (2.6 mm)
1 ea.	19-577	Frazier Ferguson Suction Tube 12 Fr. (4 mm)
1 ea.	19-844	Beyer Rongeur 7" (17.8 cm), cvd.
2 ea.	22-662	Schmidt Tonsil Forceps 7½" (19.1 cm)
1 ea.	25-385	Ruskin Bone Cutting Forceps 7½" (19.1 cm), angled
1 ea.	25-456	Stille-Luer Rongeur 8¾" (22.2 cm), cvd.

Cont'd on next page



Surgical Instrument Sets

ORTHOPEDIC SURGERY

BASIC MAJOR ORTHOPEDIC SET (Cont'd)

Quantity	Catalog No.	Description
2 ea.	27-2	Kern Bone Holding Forceps 9" (22.9 cm)
1 ea.	27-12	Lambotte Bone Holding Forceps 10 $\frac{3}{4}$ " (27.3 cm)
1 ea.	27-21	Lane Bone Holding Forceps 13" (33 cm), w/ratchet
1 ea.	27-30	Lowman Bone Clamp 5" (12.7 cm)
1 ea.	27-34	Lowman Bone Clamp 8" (20.3 cm)
2 ea.	27-230	Bone Hook 9" (22.9 cm), sharp
1 ea.	27-438	Hibbs Osteotome 9" (22.9 cm), str. $\frac{1}{4}$ " (.64 cm)
1 ea.	27-442	Hibbs Osteotome 9" (22.9 cm), str. $\frac{1}{2}$ " (1.3 cm)
1 ea.	27-446	Hibbs Osteotome 9" (22.9 cm), str. $\frac{3}{4}$ " (1.9 cm)
1 ea.	27-449	Hibbs Osteotome 9" (22.9 cm), str. 1 $\frac{1}{8}$ " (2.8 cm)
1 ea.	27-458	Hibbs Gouge 9" (22.9 cm), str. $\frac{1}{4}$ " (.64 cm)
1 ea.	27-462	Hibbs Gouge 9" (22.9 cm), str. $\frac{1}{2}$ " (1.3 cm)
1 ea.	27-466	Hibbs Gouge 9" (22.9 cm), str. $\frac{3}{4}$ " (1.9 cm)
1 ea.	27-440C	Hibbs Osteotome 9" (22.9 cm), cvd. $\frac{3}{8}$ " (.96 cm)
1 ea.	27-444C	Hibbs Osteotome 9" (22.9 cm), cvd. $\frac{5}{8}$ " (1.6 cm)
1 ea.	27-448C	Hibbs Osteotome 9" (22.9 cm), cvd. 1" (2.5 cm)
1 ea.	27-460C	Hibbs Gouge 9" (22.9 cm), cvd. $\frac{3}{8}$ " (.96 cm)
1 ea.	27-464C	Hibbs Gouge 9" (22.9 cm), cvd. $\frac{5}{8}$ " (1.6 cm)
1 ea.	27-660	Miltex Mallet 11" (27.9 cm), 16 oz. (454 g)
1 ea.	27-744	Sayre Elevator 6 $\frac{3}{4}$ " (17.1 cm), sharp
1 ea.	27-820	Key Elevator 7" (17.8 cm), $\frac{1}{4}$ " (.64 cm) wide
1 ea.	27-822	Key Elevator 7 $\frac{1}{2}$ " (19.1 cm), $\frac{1}{2}$ " (1.3 cm) wide
1 ea.	27-826	Key Elevator 8 $\frac{1}{4}$ " (21 cm), 1" (2.5 cm) wide

BASIC ORTHOPEDIC SOFT TISSUE SET

Quantity	Catalog No.	Description
1 ea.	4-7	Knife Handle No. 3
1 ea.	4-8	Knife Handle No. 4
1 ea.	5-120TC	Mayo Dissecting Scissors 5 $\frac{1}{2}$ " (14 cm), str. Carb-N-Sert blades
1 ea.	5-122TC	Mayo Dissecting Scissors 5 $\frac{1}{2}$ " (14 cm), cvd. Carb-N-Sert blades
1 ea.	5-182TC	Metzenbaum Scissors 7" (17.8 cm), cvd. Carb-N-Sert blades
1 ea.	5-514	Lister Bandage Scissors 5 $\frac{1}{2}$ " (14 cm)
1 ea.	6-46	Tissue Forceps 6" (15.2 cm), 1 x 2 T
1 ea.	6-86	Tissue Forceps 6" (15.2 cm), 4 x 5 T

Cont'd on next page

ORTHOPEDIC SURGERY

BASIC ORTHOPEDIC SOFT TISSUE SET (Cont'd)

Quantity	Catalog No.	Description
1 ea.	6-118	Adson Dressing Forceps 4¾" (12.1 cm), serr.
4 ea.	7-2	Halsted Mosquito Forceps 5" (12.7 cm), str.
4 ea.	7-4	Halsted Mosquito Forceps 5" (12.7 cm), cvd.
6 ea.	7-38	Kelly Forceps, cvd.
4 ea.	7-66	Kocher Forceps 5½" (14 cm), str.
6 ea.	7-506	Backhaus Towel Clamp 5¼" (13.3 cm)
1 ea.	8-6TC	Webster Needle Holder 5" (12.7 cm), Carb-N-Sert jaws
1 ea.	8-50TC	Crile Wood Needle Holder 6" (15.2 cm), Carb-N-Sert jaws
1 ea.	11-74	Senn Retractor 6¾" (15.9 cm), sharp
1 ea.	11-76	Senn Retractor 6¾" (15.9 cm), blunt
1 ea.	11-122	U.S. Army Retractor, Set of 2
1 ea.	11-160	Langenbeck Retractor 8" (20.3 cm), blade ¾" (.96 cm) x 1½" (3.2 cm)
1 ea.	11-164	Langenbeck Retractor 8" (20.3 cm), blade ½" (1.3 cm) x 1½" (3.8 cm)
1 ea.	11-546	Volkman Retractor, 2 prongs, sharp
1 ea.	11-547	Volkman Retractor, 3 prongs, sharp
1 ea.	11-590	Hibbs Retractor 9¼" (23.5 cm), double end
1 ea.	11-608	Weitlaner Retractor 5½" (14 cm), sharp
1 ea.	11-610	Weitlaner Retractor 5½" (14 cm), blunt
4 ea.	16-6	Allis Tissue Forceps 6" (15.2 cm), 4 x 5 T
1 ea.	18-660	Stainless Steel Ruler
1 ea.	18-1968	Freer Elevator, double end
1 ea.	19-574	Frazier Ferguson Suction Tube 9 Fr. (3 mm), angled
1 ea.	19-794	Miltex Mallet 7½" (19.1 cm), nylon and stainless faces
1 ea.	19-848	Ruskin Rongeur 6" (15.2 cm), str.
1 ea.	20-460	Frazier Ferguson Suction Tube 9 Fr. (3 mm), str.
2 ea.	21-153	Joseph Hook 6¼" (15.9 cm), single prong
2 ea.	21-158	Joseph Hook 6¼" (15.9 cm), double prong 7 mm
1 ea.	25-384	Ruskin Bone Cutting Forceps 7½" (19.1 cm), str.
1 ea.	26-1434	Adson Periosteal Elevator, curved, semi sharp
1 ea.	27-744	Sayre Elevator, double end, sharp
1 ea.	27-820	Key Elevator 7" (17.8 cm), ¼" (.64 cm) wide
1 ea.	27-822	Key Elevator 7½" (19.1 cm), ½" (1.3 cm) wide



Surgical Instrument Sets

ORTHOPEDIC SURGERY

KNEE SET

Quantity	Catalog No.	Description
1 ea.	4-7	Knife Handle No. 3
1 ea.	4-9	Knife Handle No. 7
1 ea.	5-124TC	Mayo Dissecting Scissors 6¾" (17.1 cm), str. Carb-N-Sert blades
1 ea.	5-126TC	Mayo Dissecting Scissors 6¾" (17.1 cm), cvd. Carb-N-Sert blades
1 ea.	5-180TC	Metzenbaum Scissors 5½" (14 cm), cvd. Carb-N-Sert blades
1 ea.	5-182TC	Metzenbaum Scissors 7" (17.8 cm), cvd. Carb-N-Sert blades
1 ea.	5-514	Lister Bandage Scissors 5½" (14 cm)
1 ea.	6-44	Tissue Forceps 5½" (14 cm), 1 x 2 T
1 ea.	6-118	Adson Dressing Forceps 4¾" (12.1 cm), serr.
2 ea.	6-120	Adson Tissue Forceps 4¾" (12.1 cm), 1 x 2 T
1 ea.	6-134	Martin Tissue Forceps 6" (15.2 cm), 7 x 8 T
6 ea.	7-38	Kelly Forceps 5½" (14 cm), cvd.
4 ea.	7-150	Rochester-Ochsner Forceps 6¼" (15.9 cm), str.
6 ea.	7-504	Backhaus Towel Clamp 3½" (8.9 cm)
1 ea.	8-6TC	Webster Needle Holder 5" (12.7 cm), Carb-N-Sert jaws
1 ea.	8-51TC	Crile Wood Needle Holder 7" (17.8 cm), Carb-N-Sert jaws
1 ea.	11-74	Senn Retractor 6½" (16.5 cm), sharp
1 ea.	11-76	Senn Retractor 6½" (16.5 cm), blunt
1 ea.	11-122	U.S. Army Retractor, Set of 2
1 ea.	11-546	Volkman Retractor, 2 prong, sharp
1 ea.	11-548	Volkman Retractor, 4 prong, sharp
1 ea.	11-610	Weitlaner Retractor 5½" (14 cm), blunt
4 ea.	16-6	Allis Tissue Forceps 6" (15.2 cm)
1 ea.	18-660	Stainless Steel Ruler
1 ea.	18-1968	Freer Elevator, double end
1 ea.	19-794	Miltex Mallet 7" (17.8 cm), nylon and stainless faces
1 ea.	26-1092	Adson Hook 8" (20.3 cm), blunt
1 ea.	26-1156	Graham Hook 7" (17.8 cm), blunt
1 ea.	26-1434	Adson Periosteal Elevator, curved, semi-sharp
2 ea.	27-223	Blount Knee Retractor 7" (17.8 cm)
1 ea.	27-224	Smillie Hook Retractor 5¾" (14.6 cm)
1 ea.	27-744	Sayre Elevator, double end, sharp
1 ea.	27-821	Key Elevator 7½" (17.8 cm), ¾" (.96 cm) wide
1 ea.	27-826	Key Elevator 8¼" (21 cm), 1" (2.5 cm) wide

Cont'd on next page

ORTHOPEDIC SURGERY

KNEE SET (Cont'd)

Quantity	Catalog No.	Description
1 ea.	27-970	Smillie Meniscus Knife 7¼" (18.4 cm), str.
1 ea.	27-972	Smillie Meniscus Knife 7" (17.8 cm), cvd. left
1 ea.	27-974	Smillie Meniscus Knife 7" (17.8 cm), cvd. right
1 ea.	27-980	Low-Breck Cartilage Knife 10½" (26.7 cm)
1 ea.	27-984	Downing Cartilage Knife 10" (25.4 cm)
1 ea.	27-990	Martin Cartilage Clamp 7" (17.8 cm)
1 ea.	27-1000	Martin Cartilage Scissors 8" (20.3 cm)

BASIC TOTAL HIP SET

Quantity	Catalog No.	Description
3 ea.	2-104SS	Yankauer Suction Tube
2 ea.	4-8	Knife Handle No. 4
1 ea.	4-9	Knife Handle No. 7
1 ea.	4-11	Knife Handle No. 4L
1 ea.	5-124TC	Mayo Dissecting Scissors 6¾" (17.1 cm), str. Carb-N-Sert blades
1 ea.	5-126TC	Mayo Dissecting Scissors 6¾" (17.1 cm), cvd. Carb-N-Sert blades
1 ea.	5-130TC	Mayo Dissecting Scissors 9" (22.9 cm), cvd. Carb-N-Sert blades
1 ea.	5-182TC	Metzenbaum Scissors 7" (17.8 cm), cvd. Carb-N-Sert blades
1 ea.	5-184TC	Metzenbaum Scissors 8" (20.3 cm), cvd. Carb-N-Sert blades
1 ea.	6-44	Tissue Forceps 5½" (14 cm), 1 x 2 T
1 ea.	6-84	Tissue Forceps 5½" (14 cm), 4 x 5 T
1 ea.	6-118	Adson Dressing Forceps 4¾" (12.1 cm), serr.
1 ea.	6-120	Adson Tissue Forceps 4¾" (12.1 cm), 1 x 2 T
1 ea.	6-142	Russian Tissue Forceps 6" (15.2 cm)
1 ea.	6-144	Russian Tissue Forceps 8" (20.3 cm)
6 ea.	7-4	Halsted Mosquito Forceps 5" (12.7 cm), cvd.
6 ea.	7-44	Crile Forceps 5½" (14 cm), cvd.
6 ea.	7-48	Crile Forceps 6¼" (15.9 cm), cvd.
6 ea.	7-91	Coller Forceps 6¼" (15.9 cm), cvd.
2 ea.	7-142	Rochester-Pean Forceps 8" (20.3 cm), cvd.
4 ea.	7-154	Rochester-Ochsner Forceps 8" (20.3 cm), str.
2 ea.	7-258	Gemini-Mixer Forceps 9" (22.9 cm)
6 ea.	7-506	Backhaus Towel Clamp 5¼" (13.3 cm)
1 ea.	7-600	Foerster Sponge Forceps 9½" (24.1 cm), str. serr.

Cont'd on next page



Surgical Instrument Sets

ORTHOPEDIC SURGERY

BASIC TOTAL HIP SET (Cont'd)

Quantity	Catalog No.	Description
1 ea.	8-46TC	Mayo-Hegar Needle Holder 7" (17.8 cm), Carb-N-Sert jaws
1 ea.	8-48TC	Mayo-Hegar Needle Holder 8" (20.3 cm), Carb-N-Sert jaws
1 ea.	8-51TC	Crile Wood Needle Holder 7" (17.8 cm), Carb-N-Sert jaws
1 ea.	11-260	Richardson-Eastman Retractor, Set of 2
1 ea.	11-366	Gelpi Retractor 6¾" (17.1 cm)
2 ea.	11-548	Volkman Retractor 4 prong, sharp
1 ea.	11-582	Bennett Bone Elevator 9¾" (24.8 cm), large blade
1 ea.	11-590	Hibbs Retractor 9¼" (23.5 cm)
1 ea.	11-614	Weitlaner Retractor 6¾" (16.5 cm), sharp
1 ea.	11-700	Adson Retractor 7¼" (19.1 cm)
6 ea.	16-6	Allis Tissue Forceps 6" (15.2 cm)
4 ea.	16-10	Allis Tissue Forceps 7¼" (18.4 cm)
1 ea.	18-660	Stainless Steel Ruler
1 ea.	25-396	Stille-Horsley Bone Cutting Forceps 10½" (26.7 cm)
1 ea.	25-456	Stille-Luer Rongeur 8¾" (22.2 cm), cvd.
1 ea.	25-458	Stille-Luer Rongeur 9" (22.9 cm), duckbill
2 ea.	26-122	Gigli Strully Saw Handle
1 ea.	26-132	Gigli Saw 20" (50.8 cm)
1 ea.	26-138	Bailey Saw Guide
1 ea.	26-1412	Langenbeck Periosteal Elevator, wide model
1 ea.	26-1628	Spratt Curette 9" (22.9 cm), size 00
1 ea.	26-1632	Spratt Curette 9" (22.9 cm), size 2
1 ea.	26-1636	Spratt Curette 9" (22.9 cm), size 4
1 ea.	26-1640	Spratt Curette 9" (22.9 cm), size 6
1 ea.	26-1973	Beckman-Eaton Retractor 12¾" (32.4 cm)
1 ea.	27-215	Hohman Retractor 9¼" (23.5 cm), 10 mm wide
1 ea.	27-217	Hohman Retractor 9¼" (23.5 cm), 25 mm wide
1 ea.	27-219	Hohman Retractor 9¼" (23.5 cm), 70 mm wide
1 ea.	27-230	Volkman Bone Hook 9" (22.9 cm), sharp
1 ea.	27-438	Hibbs Osteotome 9" (22.9 cm), ¼" (.64 cm)
1 ea.	27-440	Hibbs Osteotome 9" (22.9 cm), ⅜" (.96 cm)
1 ea.	27-442	Hibbs Osteotome 9" (22.9 cm), ½" (1.3 cm)
1 ea.	27-444	Hibbs Osteotome 9" (22.9 cm), ⅝" (1.6 cm)
1 ea.	27-446	Hibbs Osteotome 9" (22.9 cm), ¾" (1.9 cm)

Cont'd on next page

Surgical Instrument Sets



ORTHOPEDIC SURGERY

BASIC TOTAL HIP SET (Cont'd)

Quantity	Catalog No.	Description
1 ea.	27-660	Miltex Mallet, 16 oz. (454 g)
1 ea.	27-680	Murphy Bone Skid 12" (30.5 cm)
1 ea.	27-702	Putti Bone Rasp 12" (30.5 cm), round and half-round
1 ea.	27-826	Key Periosteal Elevator 1" (2.5 cm)

AMPUTATION SET (add Orthopedic Soft Tissue Set)

Quantity	Catalog No.	Description
2 ea.	26-122	Gigli Strully Saw Handle
1 ea.	26-132	Gigli Saw 20" (50.8 cm)
1 ea.	26-138	Bailey Saw Guide
1 ea.	26-190	Luer Bone Ronguer 7" (17.8 cm), straight
1 ea.	26-1412	Langenbeck Periosteal Elevator 7½" (19.1 cm), wide, sharp
1 ea.	27-438	Hibbs Osteotome 9" (22.9 cm), ¼" (.64 cm)
1 ea.	27-442	Hibbs Osteotome 9" (22.9 cm), ½" (1.3 cm)
1 ea.	27-446	Hibbs Osteotome 9" (22.9 cm), ¾" (1.9 cm)
1 ea.	27-448	Hibbs Osteotome 9" (22.9 cm), 1" (2.5 cm)
1 ea.	27-450	Hibbs Osteotome 9" (22.9 cm), 1¼" (3.2 cm)
1 ea.	27-700	Putti Bone Rasp 10½" (26.7 cm), flat ends
1 ea.	27-1392	Liston Bone Cutting Forceps 7½" (19.1 cm), straight
1 ea.	27-1560	Satterlee Saw, 9" (22.9 cm) blade
1 ea.	27-1602	Liston Amputation Knife, 8" (20.3 cm) blade



Surgical Instrument Sets

THORACIC AND CARDIAC SURGERY

BASIC RIB INSTRUMENT SET

Quantity	Catalog No.	Description
1 ea.	8-557C	DeBakey Needle Holder 10½" (26.7 cm), Carb-N-Sert jaws
6 ea.	16-12	Allis Tissue Forceps 10" (25.4 cm)
2 ea.	24-1602	DeBakey Multipurpose Clamp 8¼" (21 cm), 5 cm jaws
1 ea.	25-2	Doyen Rib Elevator and Raspator, right
1 ea.	25-4	Doyen Rib Elevator and Raspator, left
1 ea.	25-14	Matson-Alexander Periosteotome 8¾" (22.2 cm)
1 ea.	25-18	Matson Rib Elevator and Stripper 8¾" (22.2 cm)
1 ea.	25-142	Burford-Finochietto Rib Spreader, w/2 pr. blades
1 ea.	25-200	Bailey Rib Contractor
1 ea.	25-302	Allison Lung Retractor 12¾" (32.4 cm)
1 ea.	25-350	Bethune Rib Shears 13½" (34.9 cm)
1 ea.	25-396	Stille-Horsley Bone Cutting Forceps 10½" (26.7 cm)
1 ea.	25-480	Sauerbruch Rongeur 12" (30.5 cm), square jaws 17 mm
1 ea.	25-510	Leksell Rongeur 9½" (24.1 cm), 3 mm bite
2 ea.	25-754	Duval Tissue Grasping Forceps 9" (22.9 cm), 1" (2.5 cm) wide

THORACOTOMY SET (add Basic Laparotomy Set)

Quantity	Catalog No.	Description
1 ea.	2-104SS	Yankauer Suction Tube
1 ea.	4-7	Knife Handle No. 3
1 ea.	5-182B-TC	Metzenbaum Scissors 7" (17.8 cm), cvd., del., Carb-N-Sert blades
1 ea.	5-189TC	Metzenbaum Scissors 9" (22.9 cm), cvd., del., Carb-N-Sert blades
1 ea.	6-136	Martin Tissue Forceps 7½" (19.1 cm), 7 x 8 T
1 ea.	6-158TC	Potts-Smith Tissue Forceps 9¾" (24.8 cm), Carb-N-Sert jaws
12 ea.	7-38	Kelly Forceps 5½" (14 cm), cvd.
12 ea.	7-91	Coller Forceps 6¼" (15.9 cm), cvd.
12 ea.	7-506	Backhaus Towel Clamp 5¼" (13.3 cm)
1 ea.	8-52TC	Crile Wood Needle Holder 8" (20.3 cm), Carb-N-Sert jaws
1 ea.	8-55TC	Crile Wood Needle Holder 10½" (26.7 cm), Carb-N-Sert jaws
1 ea.	8-81TC	New Orleans Needle Holder 7" (17.8 cm), Carb-N-Sert jaws
1 ea.	8-130TC	Mayo-Hegar Needle Holder 10½" (26.7 cm), Carb-N-Sert jaws
1 ea.	11-130	Ribbon Retractor ¾" (1.9 cm), x 13" (33 cm)
1 ea.	11-134	Ribbon Retractor 1¼" (3.2 cm) x 13" (33 cm)
1 ea.	11-140	Ribbon Retractor 2" (5.1 cm) x 13" (33 cm)

Cont'd on next page

THORACIC AND CARDIAC SURGERY

THORACOTOMY SET (Cont'd)

Quantity	Catalog No.	Description
1 ea.	11-246	Richardson Retractor 1" (2.5 cm) x ¾" (1.9 cm)
1 ea.	11-248	Richardson Retractor 1½" (3.8 cm) x 1½" (3.8 cm)
1 ea.	11-266	Kelly Retractor 2" (5.1 cm) x 1½" (3.8 cm)
1 ea.	11-268	Kelly Retractor 3" (7.6 cm) x 2½" (6.4 cm)
1 ea.	11-314	Harrington Retractor 12" (30.5 cm), 2½" (6.4 cm) wide
1 ea.	11-316	Harrington Retractor 12" (30.5 cm), 1½" (3.8 cm) wide
2 ea.	11-549	Volkman Retractor 6 prongs, sharp
2 ea.	11-553	Volkman Retractor 4 prongs, blunt
1 ea.	18-1968	Freer Elevator, double end
2 ea.	24-572	DeBakey Tissue Forceps 8" (20.3 cm)
2 ea.	24-1602	DeBakey Multipurpose Clamp
1 ea.	25-2	Doyen Rib Raspatory, right
1 ea.	25-4	Doyen Rib Raspatory, left
1 ea.	25-18	Matson Rib Elevator and Stripper 8¾" (22.2 cm)
1 ea.	25-22	Alexander-Farabeuf Periosteotome 8¼" (21 cm)
1 ea.	25-142	Burford-Finocchio Rib Spreader, 2 pr. blades
1 ea.	25-200	Bailey Rib Contractor
1 ea.	25-302	Allison Lung Retractor 12¾" (32.4 cm)
1 ea.	25-456	Stille-Luer Bone Rongeur 8¾" (22.2 cm), cvd.
1 ea.	25-460	Sauerbruch Rib Rongeur 12" (30.5 cm), str. 17 mm sq. jaws
2 ea.	25-754	Duval Tissue Grasping Forcep 9" (22.9 cm), 1" (2.5 cm) wide
2 ea.	25-814	Mixer Thoracic Forceps 11" (27.9 cm)

CLOSED THORACOSTOMY SET

Quantity	Catalog No.	Description
1 ea.	4-7	Knife Handle No. 3
1 ea.	5-120TC	Mayo Dissecting Scissors 5½" (14 cm), str. Carb-N-Sert blades
2 ea.	7-46	Crile Forceps 6¼" (15.9 cm), str.
6 ea.	7-506	Backhaus Towel Clamp 5¼" (13.3 cm)
1 ea.	7-600	Foerster Sponge Forceps 9½" (24.1 cm), str., serrated
1 ea.	13-9	Patterson Trocar, Size 2, 7.5 mm
1 ea.	13-11	Patterson Trocar, Size 4, 12 mm



Surgical Instrument Sets

THORACIC AND CARDIAC SURGERY

OPEN THORACOSTOMY SET (add Thoracotomy Instruments)

Quantity	Catalog No.	Description
1 ea.	25-350	Bethune Rib Shears 13 $\frac{3}{4}$ " (34.9 cm)
1 ea.	25-360	Gluck Rib Shears 8 $\frac{1}{2}$ " (21.6 cm)

LOBECTOMY AND SEGMENTAL LUNG RESECTION SET (add Thoracotomy Instruments)

Quantity	Catalog No.	Description
1 ea.	5-192	Nelson Lobectomy Scissors 11" (27.9 cm), cvd.
6 ea.	7-142	Rochester-Pean Forceps 8" (20.3 cm)
2 ea.	7-202	Mixter Forceps 7 $\frac{1}{4}$ " (18.4 cm)
4 ea.	16-10	Allis Tissue Forceps 7 $\frac{1}{4}$ " (18.4 cm)
2 ea.	16-12	Allis Tissue Forceps 10" (25.4 cm)
2 ea.	16-54	Duval Lung Grasping Forceps 8" (20.3 cm), 1" (2.5 cm) wide
1 ea.	25-142	Burford-Finocchio Rib Spreader, 2 pr. blades
2 ea.	25-800	Sarot Intra-Thoracic Artery Forceps 9 $\frac{1}{2}$ " (24.1 cm)
2 ea.	25-814	Mixter Thoracic Forceps 11" (27.9 cm)
1 ea.	25-880	Sarot Bronchus Clamp 9" (22.9 cm), left
1 ea.	25-882	Sarot Bronchus Clamp 9" (22.9 cm), right

BASIC OPEN HEART SET

Quantity	Catalog No.	Description
2 ea.	2-104SS	Yankauer Suction Tube
1 ea.	4-7	Knife Handle No. 3
1 ea.	4-8	Knife Handle No. 4
1 ea.	4-9	Knife Handle No. 7
1 ea.	5-124TC	Mayo Dissecting Scissors 6 $\frac{3}{4}$ " (17.1 cm), str. Carb-N-Sert blades
1 ea.	5-126TC	Mayo Dissecting Scissors 6 $\frac{3}{4}$ " (17.1 cm), cvd. Carb-N-Sert blades
1 ea.	5-180TC	Metzenbaum Scissors 5 $\frac{1}{2}$ " (14 cm), cvd., Carb-N-Sert blades
2 ea.	5-182A-TC	Metzenbaum Scissors 7" (17.8 cm), cvd., delicate, Carb-N-Sert blades
1 ea.	5-184TC	Metzenbaum Scissors 8" (20.3 cm), cvd., Carb-N-Sert blades
1 ea.	5-192TC	Metzenbaum Scissors 11" (27.9 cm), cvd., Carb-N-Sert blades
1 ea.	5-193A-TC	Metzenbaum Scissors 12" (30.5 cm), cvd., Carb-N-Sert blades
2 ea.	6-120	Adson Tissue Forceps 4 $\frac{3}{4}$ " (12.1 cm), 1 x 2 T
1 ea.	6-144	Russian Tissue Forceps 8" (20.3 cm)
1 ea.	6-168	Cushing Tissue Forceps 7" (17.8 cm), 1 x 2 T

Cont'd on next page

Surgical Instrument Sets



THORACIC AND CARDIAC SURGERY

BASIC OPEN HEART SET (Cont'd)

Quantity	Catalog No.	Description
6 ea.	7-2	Halsted Mosquito Forceps 5" (12.7 cm), str.
18 ea.	7-4	Halsted Mosquito Forceps 5" (12.7 cm), cvd.
6 ea.	7-44	Crile Forceps 5½" (14 cm), cvd.
4 ea.	7-91	Coller Forceps 6¼" (15.9 cm), cvd.
4 ea.	7-144	Rochester-Pean Forceps 9" (22.9 cm), cvd.
2 ea.	7-154	Rochester-Ochsner Forceps 8" (20.3 cm), str.
2 ea.	7-202	Mixer Forceps 7¼" (18.4 cm)
2 ea.	7-252	Mosquito Forceps 8¼" (21 cm), cvd.
1 ea.	7-258	Gemini-Mixer Forceps 9" (22.9 cm)
8 ea.	7-506	Backhaus Towel Clamp 5¼" (13.3 cm)
2 ea.	7-600	Foerster Sponge Forceps 9½" (24.1 cm), str., serr.
1 ea.	8-46TC	Mayo-Hegar Needle Holder 7" (17.8 cm), Carb-N-Sert jaws
1 ea.	8-51TC	DeBakey Needle Holder 7" (17.8 cm), Carb-N-Sert jaws
1 ea.	8-53TC	DeBakey Needle Holder 9" (22.9 cm), Carb-N-Sert jaws
1 ea.	11-260	Richardson-Eastman Retractor, double end, Set of 2
4 ea.	16-12	Allis Tissue Forceps 10" (25.4 cm)
1 ea.	24-552	DeBakey Thoracic Tissue Forceps 7¾" (19.7 cm)
1 ea.	24-570	DeBakey Tissue Forceps 6" (15.2 cm)
1 ea.	24-574	DeBakey Tissue Forceps 9½" (24.1 cm)
2 ea.	24-1000	Glover Patent Ductus Clamp, str.
1 ea.	24-1600	DeBakey Multipurpose Clamp 9½" (24.1 cm), 4 cm jaws
1 ea.	24-1604	DeBakey Multipurpose Clamp 9½" (24.1 cm), 6.5 cm jaws
1 ea.	24-2110	Satinsky-DeBakey Vascular Clamp 9½" (24.1 cm), medium
4 ea.	V97-591	U.S. Pattern Tube Occluding Forceps 7½" (19.1 cm)

MAJOR CARDIOVASCULAR SET (add Basic Laparotomy Set)

Quantity	Catalog No.	Description
1 ea.	4-10	Knife Handle No. 3L
1 ea.	5-182A-TC	Metzenbaum Scissors 7" (17.8 cm), cvd. delicate, Carb-N-Sert blades
1 ea.	5-182B-TC	Metzenbaum Scissors 7" (17.8 cm), cvd. sharp points, Carb-N-Sert blades
1 ea.	5-246	Potts-Smith Scissors 7½" (19.1 cm), 25° angle



Surgical Instrument Sets

THORACIC AND CARDIAC SURGERY

MAJOR CARDIOVASCULAR SET (Cont'd)

Quantity	Catalog No.	Description
1 ea.	5-247	Potts-Smith Scissors 7½" (19.1 cm), 45° angle
1 ea.	5-248	Potts-Smith Scissors 7½" (19.1 cm), 60° angle
1 ea.	5-249A	Potts-Smith Scissors 7" (17.8 cm), 25° angle, delicate
1 ea.	6-158TC	Potts-Smith Tissue Forceps 9¾" (24.8 cm), Carb-N-Sert jaws
12 ea.	7-32	Providence Hospital Forceps 5½" (14 cm), cvd.
1 ea.	8-53TC	DeBakey Needle Holder 9" (22.9 cm), Carb-N-Sert jaws
2 ea.	11-23	Little Retractor 7¾" (19.7 cm)
1 ea.	11-102	Cushing Vein Retractor 9" (22.9 cm)
1 ea.	11-136	Ribbon Retractor 1½" (3.8 cm) x 13" (33 cm)
2 ea.	11-224A	Deaver Retractor 3" (7.6 cm) x 12" (30.5 cm), w/handle
1 ea.	11-266	Kelly Retractor 2" (5.1 cm) x 1½" (3.8 cm)
1 ea.	11-268	Kelly Retractor 3" (7.6 cm) x 2½" (6.4 cm)
1 ea.	11-314	Harrington Retractor 12" (30.5 cm) , 2½" (6.4 cm) wide
1 ea.	11-316	Harrington Retractor 12" (30.5 cm), 1½" (3.8 cm) wide
2 ea.	11-548	Volkman Retractor 4 prong, sharp
1 ea.	18-1968	Freer Elevator, double end
1 ea.	19-574	Frazier Suction Tube 9 Fr. (3 mm)
1 ea.	24-550	DeBakey Thoracic Tissue Forceps 6" (15.2 cm)
1 ea.	24-554	DeBakey Thoracic Tissue Forceps 9½" (24.1 cm)
2 ea.	24-702	Glover Bulldog Clamp 8 cm, str.
2 ea.	24-752	Glover Bulldog Clamp 8 cm, cvd.
1 ea.	24-1300	DeBakey-Semb Ligature Carrier 10¼" (26 cm)
1 ea.	24-1408	DeBakey Vascular Clamp 12¼" (31.1 cm), curved, 10 cm
1 ea.	24-1600	DeBakey Multipurpose Clamp 9½" (24.1 cm), 60° angle, 4 cm
1 ea.	24-1604	DeBakey Multipurpose Clamp 9½" (24.1 cm), 60° angle, 6.5 cm
1 ea.	24-2020	DeBakey Tangential Occlusion Clamp 10¼" (26 cm)
2 ea.	25-784	Rumel Thoracic Forceps 9" (22.9 cm), full curve

AORTIC-CORONARY GRAFT SET (add Basic Open Heart Set)

Quantity	Catalog No.	Description
1 ea.	5-246	Potts-Smith Scissors 7½" (19.1 cm), 25° angle
1 ea.	5-248	Potts-Smith Scissors 7½" (19.1 cm), 60° angle
6 ea.	7-10	Halsted Mosquito Forceps 5" (12.7 cm), cvd., delicate

Cont'd on next page

THORACIC AND CARDIAC SURGERY

AORTIC-CORONARY GRAFT SET (Cont'd)

Quantity	Catalog No.	Description
1 ea.	8-6TC	Webster Needle Holder 5" (12.7 cm), smooth, Carb-N-Sert jaws
1 ea.	11-74	Senn Retractor, sharp
1 ea.	11-76	Senn Retractor, blunt
1 ea.	11-548	Volkman Retractor, 4 prong, blunt
1 ea.	11-549	Volkman Retractor, 6 prong, blunt
1 ea.	11-608	Weitlaner Retractor 5½" (14 cm), sharp
1 ea.	19-576	Frazier-Ferguson Suction Tube, 11 Fr. (3.6 mm)
1 ea.	24-600	DeBakey Bulldog Clamp, 7.5 cm, straight
1 ea.	24-604	DeBakey Bulldog Clamp, 10.5 cm, straight
1 ea.	24-652	DeBakey Bulldog Clamp, 8.5 cm, curved
1 ea.	24-656	DeBakey Bulldog Clamp, 12 cm, curved
2 ea.	24-800	DeBakey Ring Handle Bulldog Clamp 5" (12.7 cm), str.



Surgical Instrument Sets

OPHTHALMIC SURGERY

BASIC EYE SET

Quantity	Catalog No.	Description
1 ea.	4-7	Knife Handle No. 3
1 ea.	4-9	Knife Handle No. 7
1 ea.	4-401	Miniature Blade Handle w/improved self-locking chuck 3/4" (9.5 cm), (3K type)
1 ea.	5-300	Iris Scissors 4" (10.2 cm), str.
1 ea.	5-302	Iris Scissors 4" (10.2 cm), cvd.
4 ea.	7-8	Halsted Mosquito Forceps 5" (12.7 cm), str. delicate
6 ea.	7-10	Halsted Mosquito Forceps 5" (12.7 cm), cvd. delicate
4 ea.	7-504	Backhaus Towel Forceps 3 1/2" (8.9 cm)
1 ea.	9-110	O'Brien Stitch Scissors 3/4" (9.5 cm)
1 ea.	18-2	Lancaster Eye Speculum
1 ea.	18-12	Castroviejo Eye Speculum, medium size
1 ea.	18-112	Desmarres Lid Retractor, size 2
1 ea.	18-452	Von Graefe Strabismus Hook 5 1/2" (14 cm), medium
1 ea.	18-564	Castroviejo Spatula 5 1/2" (14 cm)
1 ea.	18-650	Castroviejo Calliper 3/4" (8.3 cm)
1 ea.	18-780	Eye Dressing Forceps 4" (10.2 cm), str.
1 ea.	18-782	Eye Dressing Forceps 4" (10.2 cm), cvd.
1 ea.	18-786	Iris Forceps 4" (10.2 cm), 1 x 2 T, str.
1 ea.	18-787	Iris Forceps 4" (10.2 cm), 1 x 2 T, cvd.
1 ea.	18-850	Graefe Fixation Forceps 4 3/8" (11.2 cm)
1 ea.	18-951	Castroviejo Suturing Forceps 4" (10.2 cm), 1 x 2 T
1 ea.	18-1000	Arruga Capsule Forceps 4" (10.2 cm)
1 ea.	18-1202	Desmarres Chalazion Forceps 3 1/2" (8.9 cm), medium
1 ea.	18-1464	Stevens Tenotomy Scissors 4 1/8" (10.5 cm), cvd. blunt
1 ea.	18-1560	Castroviejo Corneal Scissors 4 1/2" (11.4 cm), right
1 ea.	18-1562	Castroviejo Corneal Scissors 4 1/2" (11.4 cm), left
1 ea.	18-1618	Micro Iris Scissors 4" (10.2 cm), str.
1 ea.	18-1620	Micro Iris Scissors 4" (10.2 cm), cvd.
1 ea.	18-1652	Eye Suture (Gradle) Scissors 3/4" (9.5 cm), slightly cvd.
1 ea.	18-1828TC	Castroviejo Needle Holder 5 1/2" (14 cm), str. w/lock, Carb-N-Sert jaws
2 ea.	18-2200	Fox Eye Shields, aluminum

Surgical Instrument Sets



OPHTHALMIC SURGERY

CATARACT SURGERY SET (add Basic Eye Set)

Quantity	Catalog No.	Description
1 ea.	18-33	Maumenee-Park Eye Speculum, w/lock screws
1 ea.	18-172	Troutman-Barraquer Blade Breaker
1 ea.	18-452	Von Graefe Strabismus Hook 5½" (14 cm), medium size
1 ea.	18-486	Wilder Lens Loop 5¼" (13.3 cm), smooth
1 ea.	18-613	Kirby Hook and Expressor 6" (15.2 cm)
1 ea.	18-827	Troutman-Barraquer Colibri Corneal Forceps 0.4 mm, 3" (7.6 cm)
1 ea.	18-904	O'Brien Fixation Forceps 4" (10.2 cm), 1 x 2 T
1 ea.	18-952	Castroviejo Suturing Forceps 4" (10.2 cm), 0.6 mm teeth
1 ea.	18-1049	Castroviejo Capsule Forceps 4" (10.2 cm), new curve
1 ea.	18-1487	Westcott Tenotomy Scissors 5¼" (13.3 cm), right
1 ea.	18-1524	DeWecker Iris Scissors 4¼" (10.8 cm), sharp points
1 ea.	18-1558	Castroviejo Corneal Scissors 4" (10.2 cm), right, 6 mm blades
1 ea.	18-1559	Castroviejo Corneal Scissors 4" (10.2 cm), left, 6 mm blades
1 ea.	18-1832TC	Castroviejo Needle Holder 5½" (14 cm), cvd. w/lock, Carb-N-Sert jaws

EYE MUSCLE AND ENUCLEATION SET (add Basic Eye Set)

Quantity	Catalog No.	Description
1 ea.	5-312	Strabismus Scissors 4" (10.2 cm), str.
1 ea.	5-314	Strabismus Scissors 4" (10.2 cm), cvd.
1 ea.	7-256	Gemini-Mixter Forceps 7" (17.8 cm), delicate
2 ea.	7-280	Serrefine 1½" (3.8 cm), str.
1 ea.	18-62	McKinney Eye Speculum
1 ea.	18-904	O'Brien Fixation Forceps 4" (10.2 cm), 1 x 2 T
1 ea.	18-1252	Prince Advancement Forceps 3½" (9.5 cm)
1 ea.	18-1498	Enucleation Scissors 5" (12.7 cm), full curve

RETINAL SURGERY SET (add Basic Eye Set)

Quantity	Catalog No.	Description
2 ea.	7-280	Serrefine 1½" (3.8 cm), str.
1 ea.	18-446	Jameson Strabismus Hook 5" (12.7 cm)
1 ea.	18-452	Von Graefe Strabismus Hook 5½" (14 cm), medium
1 ea.	18-910	Gifford Fixation Forceps 4" (10.2 cm), 1 x 2 T
1 ea.	18-966	McCullough Suturing Forceps 4" (10.2 cm), 1 x 2 T
1 ea.	18-1487	Westcott Tenotomy Scissors 5¼" (13.3 cm), right



Surgical Instrument Sets

OPHTHALMIC SURGERY

DACRYOCYSTORRHINOSTOMY SET (add Basic Eye Set)

Quantity	Catalog No.	Description
1 ea.	4-7	Knife Handle No. 3
1 ea.	5-180A-TC	Metzenbaum Scissors, 5½" (14 cm), delicate, Carb-N-Sert blades
1 ea.	9-124	Wire Cutting Scissors 4¾" (12.1 cm), angular
1 ea.	18-34	Wire Speculum
1 ea.	18-88	Goldstein Lachrymal Sac Retractor
1 ea.	18-412	Tyrell Hook 5" (12.7 cm), sharp
1 ea.	18-660	Stainless Ruler 6" (15.2 cm)
1 ea.	18-691	Castroviejo Lacrimal Dilator 5½" (14 cm), double end
1 ea.	18-740	Bowman Probe size 4/0 and 3/0
1 ea.	18-742	Bowman Probe size 2/0 and 0
1 ea.	18-744	Bowman Probe size 1 and 2
1 ea.	18-746	Bowman Probe size 3 and 4
1 ea.	18-784	Eye Dressing Forceps 4" (10.2 cm), full cvd.
1 ea.	18-1960	Freer Chisel 6½" (16.5 cm), cvd.
1 ea.	18-1962	West Chisel 6½" (16.5 cm), str.
1 ea.	18-1968	Freer Elevator 7" (17.8 cm), double end
1 ea.	18-1990	Kerrison Rongeur, 3.5 mm bite, 3" (7.6 cm) shaft
1 ea.	19-192	Lathbury Applicator 5½" (14 cm)
1 ea.	19-370	Lucae Bayonet Forceps 5½" (14 cm)
1 ea.	19-572	Frazier Ferguson Suction Tube 7 Fr. (2.3 mm)
1 ea.	19-580	Baron Suction Tube 3 Fr. (1 mm)
1 ea.	19-793	Millex Mallet 7½" (19.1 cm), stainless and nylon faces
1 ea.	19-1232	Lempert Rongeur 6¼" (15.9 cm), cvd.
1 ea.	20-24	Beckman Nasal Speculum 6" (15.2 cm)
1 ea.	20-36-50	Cottle Septum Speculum, 50 mm blades
1 ea.	20-570	Takahashi Nasal Forceps, 2.5 x 10 mm bite, 4½" (11.4 cm) shaft

EAR, NOSE AND THROAT SURGERY

BASIC EAR SET

Quantity	Catalog No.	Description
1 ea.	4-7	Knife Handle No. 3
1 ea.	5-122TC	Mayo Dissecting Scissors 5½" (14 cm), cvd. Carb-N-Sert blades
1 ea.	5-180A-TC	Metzenbaum Scissors 5½" (14 cm), cvd., delicate, Carb-N-Sert blades
1 ea.	5-182A-TC	Metzenbaum Scissors 7" (17.8 cm), cvd., delicate, Carb-N-Sert blades
1 ea.	5-314	Strabismus Scissors 4" (10.2 cm), cvd.
1 ea.	6-118	Adson Dressing Forceps 4¾" (12.1 cm), serr.
1 ea.	6-120	Adson Tissue Forceps 4¾" (12.1 cm), 1 x 2 T
6 ea.	7-2	Halsted Mosquito Forceps 5" (12.7 cm), str.
2 ea.	7-36	Kelly Forceps 5½" (14 cm), str.
4 ea.	7-504	Backhaus Towel Clamp 3½" (8.9 cm)
1 ea.	8-8A-TC	Halsey Needle Holder 5" (12.7 cm), serrated, Carb-N-Sert jaws
1 ea.	9-124	Wire Cutting Scissors 4¾" (12.1 cm), angular
1 ea.	11-2	Jansen Retractor 4¼" (10.8 cm), blunt
1 ea.	11-6	Allport Retractor 4" (10.2 cm), sharp
2 ea.	11-74	Senn Retractor 6¾" (16.2 cm), sharp
1 ea.	11-160	Langenbeck Retractor ¾" (.95 cm) x 1¼" (3.2 cm)
1 ea.	11-164	Langenbeck Retractor ½" (1.3 cm) x 1½" (3.8 cm)
2 ea.	16-6	Allis Tissue Forceps 6" (15.2 cm)
1 ea.	18-850	Graefe Tissue Forceps 4¾" (11.2 cm)
1 ea.	18-1968	Freer Elevator 7" (17.8 cm), double end
1 ea.	19-50-1	Farrier Ear Speculum size 1
1 ea.	19-50-3	Farrier Ear Speculum size 3
1 ea.	19-50-5	Farrier Ear Speculum size 5
1 ea.	19-50-7	Farrier Ear Speculum size 7
1 ea.	19-260	Buck Ear Curette, size 00, str. sharp
1 ea.	19-264	Buck Ear Curette, size 1, str. sharp
1 ea.	19-371	Jansen Ear Forceps 6¼" (15.9 cm)
1 ea.	19-572	Frazier Ferguson Suction Tube 7 Fr. (2.3 mm)
1 ea.	19-574	Frazier Ferguson Suction Tube 9 Fr. (3 mm)
1 ea.	19-660	Wullstein Endaural Retractor
2 ea.	21-153	Joseph Single Hook 6¼" (15.9 cm)



Surgical Instrument Sets

EAR, NOSE AND THROAT SURGERY

MYRINGOTOMY SET

Quantity	Catalog No.	Description
1 ea.	5-270	Plastic Surgery Scissors 4¾" (12.1 cm), str. sharp points
1 ea.	19-50-1	Farrier Ear Speculum, size 1
1 ea.	19-50-3	Farrier Ear Speculum, size 3
1 ea.	19-50-5	Farrier Ear Speculum, size 5
1 ea.	19-50-7	Farrier Ear Speculum, size 7
1 ea.	19-192	Lathbury Applicator 5½" (14 cm)
1 ea.	19-270	Buck Ear Curette, size 00 angled, sharp
1 ea.	19-274	Buck Ear Curette, size 1 angled, sharp
1 ea.	19-371	Jansen Ear Forceps 6¼" (15.9 cm)
1 ea.	19-500	Sexton Ear Knife 7" (17.8 cm), str.
1 ea.	19-572	Frazier Ferguson Suction Tube 7 Fr. (2.3 mm)
1 ea.	19-582	Baron Suction Tube 5 Fr. (1.7 mm)

BASIC NASAL SET

Quantity	Catalog No.	Description
1 ea.	2-104SS	Yankauer Suction Tube
1 ea.	4-7	Knife Handle No. 3
1 ea.	4-9	Knife Handle No. 7
1 ea.	5-122TC	Mayo Dissecting Scissors 5½" (14 cm), cvd., Carb-N-Sert blades
1 ea.	5-180A-TC	Metzenbaum Scissors 5½" (14 cm), cvd., delicate, Carb-N-Sert blades
1 ea.	5-182A-TC	Metzenbaum Scissors 7" (17.8 cm), cvd., delicate, Carb-N-Sert blades
1 ea.	5-276	Plastic Surgery Scissors 4¾" (12.1 cm), cvd., S/S
2 ea.	6-120	Adson Tissue Forceps 4¾" (12.1 cm), 1 x 2 T
6 ea.	7-2	Halsted Mosquito Forceps 5" (12.7 cm), str.
4 ea.	7-504	Backhaus Towel Clamp 3¾" (8.9 cm)
1 ea.	8-8A-TC	Halsey Needle Holder 5" (12.7 cm), serr., Carb-N-Sert jaws
2 ea.	11-74	Senn Retractor, sharp
1 ea.	11-122	U.S. Army Retractor, Set of 2
2 ea.	16-4	Baby Allis Tissue Forceps 5" (12.7 cm)
1 ea.	18-850	Graefe Forceps 4¾" (11.2 cm)
1 ea.	19-202	Farrell Applicator 6½" (16.5 cm)
2 ea.	19-572	Frazier Suction Tube, 7 Fr. (2.3 mm)

Cont'd on next page

EAR, NOSE AND THROAT SURGERY

BASIC NASAL SET (Cont'd)

Quantity	Catalog No.	Description
1 ea.	20-3	Vienna Nasal Speculum, medium
1 ea.	20-30	Killian Septum Speculum, 3" (7.6 cm) blades
1 ea.	20-36-50	Cottle Septum Speculum, 50 mm delicate blades
1 ea.	20-120	Wilde Nasal Dressing Forceps 6½" (16.5 cm)
1 ea.	21-153	Joseph Single Hook
1 ea.	21-154	Joseph Double Hook, 2 mm
1 ea.	21-158	Joseph Double Hook, 7 mm
1 ea.	21-188	Aufricht Nasal Retractor-Speculum 6½" (16.5 cm)
1 ea.	21-630	Joseph Nasal Scissors 5¾" (14.6 cm), str.
1 ea.	21-632	Joseph Nasal Scissors 5¾" (14.6 cm), cvd.

MINOR NASAL SET

Quantity	Catalog No.	Description
1 ea.	10-220	Anthony Suction Tube
1 ea.	20-3	Vienna Nasal Speculum, medium
1 ea.	20-30	Killian Septum Speculum, 3" (7.6 cm) blades
1 ea.	20-36-50	Cottle Septum Speculum, 50 mm delicate blades
1 ea.	20-140	Noyes Alligator Forceps 5½" (14 cm), serr.
1 ea.	20-572	Takahashi Ethmoid Forceps 4½" (11.4 cm), 2.5 mm bite

MAJOR NASAL SET (add Basic Nasal Set)

Quantity	Catalog No.	Description
1 ea.	5-180A-TC	Metzenbaum Scissors 5½" (14 cm), cvd. B/B, Carb-N-Sert blades
1 ea.	5-182A-TC	Metzenbaum Scissors 7" (17.8 cm), cvd. B/B, Carb-N-Sert blades
1 ea.	5-300	Iris Scissors 4" (10.2 cm), str.
1 ea.	5-312	Strabismus Scissors 4" (10.2 cm), str.
1 ea.	5-314	Strabismus Scissors 4" (10.2 cm), cvd.
1 ea.	6-118	Adson Dressing Forceps 4¾" (12.1 cm), serr.
1 ea.	6-197	Jansen (Gruenwald) Bayonet Dressing Forceps 6¼" (15.9 cm)
1 ea.	8-51TC	Crile-Wood Needle Holder 7" (17.8 cm), Carb-N-Sert jaws
1 ea.	18-110	DesMarres Lid Retractor
1 ea.	18-650	Castroviejo Caliper 3¼" (8.3 cm)
1 ea.	18-660	Stainless Steel Ruler
1 ea.	18-1968	Freer Elevator 7" (17.8 cm), double end

Cont'd on next page



Surgical Instrument Sets

EAR, NOSE AND THROAT SURGERY

MAJOR NASAL SET (Cont'd)

Quantity	Catalog No.	Description
1 ea.	19-172	Uebe Applicator 7" (17.8 cm), cross serrated
1 ea.	19-794	Miltex Mallet 7½" (19.1 cm)
1 ea.	20-30	Killian Septum Speculum 6" (15.2 cm)
2 ea.	20-36-50	Cottle Septum Speculum 6" (15.2 cm)
1 ea.	20-124	Hartman Nasal Dressing Forceps 7" (17.8 cm)
1 ea.	20-218	Ballengier Swivel Knife, str., 3 mm
1 ea.	20-224	Ballengier Swivel Knife 7¾" (19.7 cm), bayonet
1 ea.	21-24	Converse Bistouri 6" (15.2 cm), cvd.
1 ea.	21-28	Fomon Knife 5½" (14 cm), double edge, cvd.
1 ea.	21-32	Cottle Nasal Knife 5½" (14 cm)
1 ea.	21-64	Joseph Elevator 7" (17.8 cm), cvd.
1 ea.	21-68	Fomon Periosteal Elevator 6¼" (15.9 cm)
1 ea.	21-89	Gillies Skin Hook 7" (17.8 cm)
1 ea.	21-144	Cottle Double Hook 5½" (14 cm), sharp
1 ea.	21-148	Fomon Retractor 6½" (16.5 cm), double ball end prongs
1 ea.	21-150	Cottle Retractor 5½" (14 cm), 4 prong
1 ea.	21-153	Joseph Single Hook 6¼" (15.9 cm)
2 ea.	21-156	Joseph Double Hook 6¼" (15.9 cm), sharp, 5 mm
1 ea.	21-163	Converse Alar Retractor 4" (10.2 cm)
1 ea.	21-165	Cottle Knife Guide and Retractor 8" (20.3 cm)
1 ea.	21-176	Neivert Knife Guide and Retractor 6½" (16.5 cm), double end
1 ea.	21-205-4	Sheehan Osteotome 6¼" (15.9 cm), 4 mm
1 ea.	21-205-8	Sheehan Osteotome 6¼" (15.9 cm), 8 mm
1 ea.	21-205-10	Sheehan Osteotome 6¼" (15.9 cm), 10 mm
1 ea.	21-205-12	Sheehan Osteotome 6¼" (15.9 cm), 12 mm
1 ea.	21-212	Cottle Septum Chisel 7¼" (18.4 cm), cvd.
1 ea.	21-215	Cinelli Osteotome 6½" (16.5 cm)
1 ea.	21-232	Neivert Osteotome 8" (20.3 cm)
1 ea.	21-280	Joseph Nasal Saw 7½" (19.1 cm), str.
1 ea.	21-330	Joseph Rasp 6¼" (15.9 cm)
1 ea.	21-342	Maltz Rasp 7" (17.8 cm)
1 ea.	21-343	Maltz Rasp D/E 8¼" (21 cm)
1 ea.	21-348	Aufrecht Glabella Rasp 8¼" (21 cm)

Cont'd on next page

EAR, NOSE AND THROAT SURGERY

MAJOR NASAL SET (Cont'd)

Quantity	Catalog No.	Description
1 ea.	21-440	Cottle Columella Forceps 4½" (11.4 cm)
1 ea.	21-602	Fomon Lower Lateral Scissors 5" (12.7 cm), cvd.
1 ea.	21-604TC	Fomon Dorsal Scissors 5½" (14 cm), angular, Carb-N-Sert blades
1 ea.	21-610	Cottle Dorsal Scissors 6½" (16.5 cm)
1 ea.	21-660	Ash Septum Straightener 9" (22.9 cm)
2 ea.	22-662	Schmidt Hemostatic Forceps 7½" (19.1 cm)

TONSILLECTOMY AND ADENOIDECTOMY SET

Quantity	Catalog No.	Description
1 ea.	2-104SS	Yankauer Suction Tube
1 ea.	2-180	Molvor Mouth Gag w/3 blades
1 ea.	4-9	Knife Handle No. 7
1 ea.	5-182TC	Metzenbaum Scissors 7" (17.8 cm), cvd., Carb-N-Sert blades
1 ea.	7-190	Miculicz Tonsil Forceps 7½" (19.1 cm)
4 ea.	7-506	Backhaus Towel Clamp 5¼" (13.3 cm)
1 ea.	7-604	Ballenger Sponge Forceps 7" (17.8 cm), str., serrated
1 ea.	8-50TC	Crile-Wood Needle Holder 6" (15.2 cm), Carb-N-Sert jaws
1 ea.	8-52TC	Crile-Wood Needle Holder 8" (20.3 cm), Carb-N-Sert jaws
1 ea.	20-800	Barnhill Adenoid Curette 8½" (21.6 cm), size 0
1 ea.	20-802	Barnhill Adenoid Curette 8½" (21.6 cm), size 1
1 ea.	20-804	Barnhill Adenoid Curette 8½" (21.6 cm), size 2
1 ea.	20-836	Love Uvula Retractor, 18 mm
1 ea.	20-850	LaForce Adenotome 9½" (24.1 cm), extra small, size 0
1 ea.	20-854	LaForce Adenotome 9½" (24.1 cm), medium, size 2
1 ea.	20-926	Meltzer Adenoid Punch, size 1, triangular jaws
1 ea.	22-4	Wieder Tongue Depressor, large
1 ea.	22-550	White Tonsil Seizing Forceps 7½" (19.1 cm), cvd.
6 ea.	22-662	Schmidt Tonsil Forceps 7½" (19.1 cm)
1 ea.	22-666	Sawtell Tonsil Forceps 7½" (19.1 cm)
1 ea.	22-808	Fischer Tonsil Knife and Dissector 8½" (21.6 cm)
1 ea.	22-854	Hurd Tonsil Dissector and Pillar Retractor 9" (22.9 cm)
1 ea.	22-1010	Beck-Schenck Tonsil Snare with 1 straight and 3 vedder tips
1 ea.	22-1030	Sage Automatic Ratchet Tonsil Snare



Surgical Instrument Sets

SUTURE

E.R. SUTURE SET

Quantity	Catalog No.	Description
1 ea.	4-7	Knife Handle No. 3
1 ea.	5-290	Ragnell Dissecting Scissors 5" (12.7 cm)
1 ea.	5-16	Operating Scissors 5½" (14 cm), str. S/B
1 ea.	6-118	Adson Dressing Forceps 4¾" (12.1 cm), serr.
1 ea.	6-120	Adson Tissue Forceps 4¾" (12.1 cm), 1 x 2 T
2 ea.	7-2	Halsted Mosquito Forceps 5" (12.7 cm), str.
2 ea.	7-4	Halsted Mosquito Forceps 5" (12.7 cm), cvd.
1 ea.	7-36	Kelly Forceps 5½" (14 cm), str.
1 ea.	7-38	Kelly Forceps 5½" (14 cm), cvd.
2 ea.	7-504	Backhaus Towel Clamp 3½" (8.9 cm)
1 ea.	8-50TC	Crile-Wood Needle Holder 6" (15.2 cm), Carb-N-Sert jaws

SMALL SUTURE SET (For Doctor's Office or E.R.)

Quantity	Catalog No.	Description
1 ea.	4-7	Knife Handle No. 3
1 ea.	5-312	Strabismus Scissors 4¼" (10.8 cm), str.
1 ea.	5-314	Strabismus Scissors 4¼" (10.8 cm), cvd.
2 ea.	6-120	Adson Tissue Forceps 4¾" (12.1 cm), 1 x 2 T
4 ea.	7-4	Halstead Mosquito Forceps 5" (12.7 cm), cvd.
2 ea.	7-26	Hartman Mosquito Forceps 3½" (8.9 cm), cvd.
2 ea.	8-6TC	Webster Needle Holder 5" (12.7 cm), smooth Carb-N-Sert jaws

- A**
- Abbey Needle Holders 113, 341
- Abdominal Scissors 23
- Adair Tissue Tenaculum 208, 501
- Adenoid Curettes 304
- Adenoid Punches 306
- Adenoids 305
- Adson Aneurysm Needle 143, 425
- Adson Bayonet
Forceps 73, 89, 275, 292, 429
- Adson Cannula 425
- Adson Dressing Forceps ... 68, 69, 88, 220,
..... 322, 427, 537, 538
- Adson Dura Hooks 192, 431
- Adson Ganglion Scissors 423
- Adson Hemostatic Forceps 103, 430
- Adson Needle Holders 116
- Adson Periosteal Elevators 434
- Adson Retractors 187, 412, 438
- Adson Rongeurs 414
- Adson Suction Tubes 149, 426
- Adson Tissue Forceps 68, 70, 88, 220,
..... 323, 427, 537, 538
- Aebli Corneal Scissors 48, 261
- Agricola Lacrimal Sac Retractor ... 153, 228
- Alexander Chisels 284, 449
- Alexander Gouges 284, 449
- Alexander-Farabeuf Periosteotomes ... 388
- Allen Intestinal Clamp 104, 210
- Allen-Schlotz Tonometers 230
- Allis Tissue Forceps 206, 400, 477
- Allis-Adair Tissue Forceps 206, 476
- Allison Lung Retractor 171, 394
- Allport Mastoid Searcher 190, 273
- Allport Retractors 151, 280
- Alm Retractors 152, 281, 545
- Alvin Fixation Forceps 245, 541
- Alvis Foreign Body Spud 233
- Amniotome 518
- Amputating Knives 465
- Anastomosis Clamps 210, 378, 384, 385
- Anderson Osteotomes 315
- Andrews Tongue Depressor 347
- Andrews-Pynchon Suction
Tubes 6, 147, 351, 357
- Anesthesia Instruments 5-7
- Aneurysm Needle 425, 553
- Angiotribes 107
- Anoscopes 471
- Anthony Suction Tube .. 147, 149, 279, 299
- Antrum Cannula 298, 299
- Antrum Curettes 297
- Antrum Needles 298
- Antrum Rasps 297
- Antrum Rongeurs 303
- Applicators, Ear 273
- Applicators, Laryngeal 363
- Applicators, Nasal 291
- Approximator Set For Clips 223
- Arruga Capsule Forceps 249
- Arruga Lacrimal Trephines 268
- Ash Septum Straightening Forceps..... 338
- Atraumatic Instruments 82, 373-387
- Attic Cannula 279
- Aufricht Nasal Retractors 157, 313
- Aufricht Rasps 319
- Auvard Vaginal Specula 492
- Ayer Chalazion Forceps 262
- B**
- Babcock Suture Wire 135
- Babcock Tissue Forceps 207, 400
- Baby Crie Forceps 92, 327
- Baby Ochsner Forceps 93, 327
- Baby Pean Forceps 94, 327
- Backhaus Towel Clamps 109
- Bacon Rongeur 414, 459
- Badgley Retractors 186, 437
- Badgley Rib Spreader 391
- Bailey Gigli Saw Guide 413, 464
- Bailey Rib Contractors 392
- Bailey-Gibbon Rib Contractor 392
- Bailey-Williamson Obstetrical Forceps. 522
- Bainbridge Forceps 103, 197, 209
- Bakes Dilators 199
- Balfour Retractors 177-179
- Ballantine Hysterectomy Forceps .. 96, 513
- Ballenger Chisels 296, 315
- Ballenger Sponge Forceps 356
- Ballenger Swivel Knives 295, 315
- Ballenger Tonsil Seizing Forceps 355
- Bandage And Utility Scissors ... 51, 52, 466
- Bane Rongeur 285, 353, 414, 459
- Barany Noise Apparatus 271
- Barkan Goniotomy Knife 232
- Barnhill Adenoid Curettes 304
- Baron Suction Tubes 149, 279, 426
- Barr Anal Retractor 174, 469
- Barr Crypt Hook 194
- Barr Probes 145, 146, 474
- Barr-Shuford Rectal Speculum 473
- Barraquer Blade Breaker 231
- Barraquer Cilia Forceps 80, 251
- Barraquer Eye Specula 227
- Barraquer Iris Scissors 92, 259
- Barraquer Needle
Holders 121, 265, 346, 536
- Barrett Uterine Tenaculum Forceps 501
- Baumgartner Needle
Holders 114, 124, 342, 635
- Beacham Amniotome 518
- Beaupre Cilia Forceps 80, 251
- Beck-Schenck Tonsil Snare 360
- Becker Cystotome 232
- Beckman Nasal Speculum 289
- Beckman Retractors 187, 196, 438
- Beckman-Eaton Retractor 173, 439
- Beckman-Weitlaner
Retractors 184, 195, 282, 412, 438
- Beer Cilia Forceps 79, 250
- Beeson Cast Spreader 468
- Bellucci Micro Ear Scissors ... 49, 217, 288
- Bennett Cilia Forceps 80, 251
- Bennett Bone Elevator 446
- Bennett Tibia Retractors 182
- Benson Pylorus Separator 213
- Bergh Cilia Forceps 80, 251
- Berke Ptosis Forceps 252, 325
- Best Colon Clamps 214
- Bethune Rib Shears 394
- Beyer Rongeur 286, 353, 415, 461
- Bihrie Needle Holder Clamp 128, 488
- Bill Obstetrical Traction Handle 519
- Billeau Ear Loops 274
- Billroth Tumor Forceps 505
- Binoocular Loupe 4
- Biopsy Forceps, Rectal 479-481
- Biopsy Forceps, Uterine 486, 509-512
- Biopsy Needles 198
- Biopsy Punches, Cervical 510-512
- Biopsy Punches, Disposable 526



Biro Dermal Naevus Scissors	38, 332, 531
Bishop Mastoid Gouges	284
Bishop-Harmon Dressing Forceps	76, 244, 322, 541
Bishop-Harmon Tissue Forceps	76, 221, 244, 322, 541
Bistouri, Tracheal	369
Bladder Retractors	486
Blade Breakers	231
Blade Remover	15
Blade-Safe Blade Remover	15
Blades, Surgical	15-17
Blair Cleft Palate Elevators	351
Blake Dressing Forceps	81
Blake Ear Forceps	275
Blake Gail Stone Forceps	205
Blakesley Ethmoid Forceps	302
Blaphoroplasty Scissors	59, 335, 531
Blount Knee Retractor	183, 446
Blumenthal Rongeurs	352, 459
Bodenhammer Rectal Speculum	469
Boettcher Scissors	28, 359
Bonaccollo Utility Forceps	79, 248
Bone Chisels	449, 450
Bone Clamps	441, 442
Bone Curettes	318, 436, 456, 457
Bone Cutting Forceps	338, 395, 462, 463, 553
Bone Elevators	446
Bone File	454
Bone Gouges	449, 451, 452
Bone Holding Forceps	440, 441
Bone Hooks	188, 447
Bone Mallets	453
Bone Rasps	454
Bone Retractors	446-448
Bone Rongeurs	459-462
Bone Saws	465
Bone Skid	454
Bone Wire Guide	143, 442
Bonn Iris Scissors	31, 254, 330, 528
Bonn Suturing Forceps	75, 76, 220, 244
Bonney Tissue Forceps	70
Bosworth Tongue Depressor	347
Botvin Iris Forceps	75, 244
Boucheron Ear Specula	269
Bower Sphenoid Cannula	299
Bowman Lacrimal Probas	145, 240
Bowman Needle	232
Boynton Needle Holder	114, 265, 342, 535
Boys-Allis Tissue Forceps	207
Bozeman Sponge Forceps	111, 498
Braasch Biopsy Forceps	486
Braces, Neurosurgical	410
Bracken Iris Forceps	74, 242
Braun Epistomy Scissors	23, 516
Braun Tenaculum Forceps	500
Breast Tenaculum Forceps	501
Bridge Forceps	99, 403
Brinkerhoff Rectal Specula	472
Bronchial and Esophageal Instruments	365, 366
Bronchoscopic Forceps	365
Bronchus Clamps	404
Brophy Scissors	35, 331, 351
Brown Applicators	273, 291
Brown Needle Holders	114, 342
Brown Tissue Forceps	71, 324, 399, 429
Brown Tonsil Snare	361
Brown-Adson Tissue Forceps	68, 70, 71, 88, 324, 428, 538
Bruening Ear Snare	277
Bruening Laryngeal Tip	364
Bruening Nasal Snare	294
Bruening Otoloscope	270
Bruening Septum Forceps	301
Brun Bone Curettes	436, 456
Brun Mastoid Curettes	284
Brunner Intestinal Forceps	212
Bruns Cast Shears	53, 467
Brush For Rasps and Files	12, 319
Brushes, Instrument Cleaning	11, 319
Brushes, Trachea Tubes	372
Buck Curettes	274, 525
Buck Ear Probes	145, 273
Buck Neuro Hammers	1
Buie Anal Retractors	470
Buie Biopsy Forceps	479
Buie Fistula Probe	146, 474
Buie Pile Clamp	477
Buie Suction Tube	149, 481
Bulldog Clamp Applying Forceps	406
Bulldog Clamps	108, 224, 267, 327, 406
Bulldog Scissors	37, 337
Bumm Uterine Curettes	506
Bunge Evisceration Spoons	236
Bunnell Hand Drill	445
Bunnell Tendon Strippers	458
Bunt Forceps Holder	8
Burford-Finocchetto Rib Spreaders	390
Burke Cervical Biopsy Punch Forceps	510
Burs, Neurosurgical	409, 410
Busch Scissors	23, 523
Busch Umbilical Scissors	523
Button End Knives	307
Buxton Uterine Forceps	505
C	
C-N-S Pin & Wire Pullers	444
C-N-S Wire Cutting Scissors	59
CTS Sterilization Trays	10
Calipers, E.K.G.	3
Calipers, Eye	239
Calipers, Plastic Surgery	317
Canfield Tonsil Knife	358
Cannula Occlusion Clamp	12
Cannula, Antrum	298, 299
Cannula, Attic	279
Cannula, Laryngeal	364
Cannula, Sinus	298
Cannula, Sphenoid	299
Caplan Nasal Bone Scissors	38, 337
Capsule Forceps	249, 250, 487
Capsulotomy Scissors	262
Carb-N-Sert Dressing Forceps	88, 89
Carb-N-Sert Needle Holders	122-130, 222, 266
Carb-N-Sert Pin Cutter	443, 444
Carb-N-Sert Pin Puller	142, 444
Carb-N-Sert Scissors	54-59
Carb-N-Sert Tissue Forceps	88, 89
Cardiovascular Clamps	378-381, 384-387
Cardiovascular Scissors	26, 405
Carmalt Splinter Forceps	83
Cartilage Clamps	458
Cartilage Knives	457
Cartilage Scissors	25, 458
Cases, Sterilizing	230
Cast & Utility Shears	53, 466, 467
Cast Instruments	53, 466-468
Cast Spreaders	468

- Castanares Facelift Scissors336
 Castroviejo Blade Breaker231
 Castroviejo Caliper239, 317
 Castroviejo Capsule Forceps249
 Castroviejo Colibri Corneal
 Forceps77, 245
 Castroviejo Corneal
 Scissors43, 47, 216, 260, 261
 Castroviejo Corneal Section
 Scissors47, 260
 Castroviejo Cyclodialysis Spatula237
 Castroviejo Eye Specula225
 Castroviejo Fixation Forceps245, 541
 Castroviejo Keratoplasty Scissors261
 Castroviejo Lacrimal Dilators240
 Castroviejo Needle Holders120, 128,
 129, 264, 266, 345, 346, 536
 Castroviejo Spatula237
 Castroviejo Suturing Forceps247, 541
 Cataract Knives231
 Catheter Guide485
 Catheter Introducing Forceps5
 Catheters, Eustachian274
 Catheters, Urethral484
 Cautery239
 Cerebellar Retractors412
 Cervix Holding Forceps499
 Chalazion Curettes236
 Chalazion Forceps252, 253, 325
 Chandler Elevators455
 Chandler Iris Forceps75, 243
 Charrere Bone Saws465
 Cheatele Sterilizer Forceps8
 Cheek Retractors162, 347, 348
 Chelsea-Eaton Anal Specula473
 Cheron Uterine Dressing Forceps498
 Child Intestinal Forceps209
 Childrens Hospital Spatula425
 Chisels, Bone449, 450
 Chisels, Lacrimal Sac268
 Chisels, Mastoid284
 Chisels, Plastic Surgery313-315
 Chisels, Septum296, 313
 Cichereilli Rongeur459
 Cilia Forceps79, 80, 250, 251, 541
 Cinelli Osteotomes314
 Clamps, Anastomosis210, 384, 385
 Clamps, Bone441, 442
 Clamps, Bronchus404
 Clamps, Bulldog108, 374-376, 406
 Clamps, Cannula Occlusion12
 Clamps, Cardiovascular378-381, 384-387
 Clamps, Cartilage458
 Clamps, Coarctation377, 404
 Clamps, Colon214
 Clamps, Cystic Duct Catheter204
 Clamps, Intestinal210, 212-214
 Clamps, Kidney488
 Clamps, Multipurpose381, 382, 385
 Clamps, Muscle197
 Clamps, Occlusion12, 383
 Clamps, Patent Ductus377, 378
 Clamps, Peripheral Vascular378
 Clamps, Peritoneal515
 Clamps, Pile477
 Clamps, Pyloric213
 Clamps, Thoracic404
 Clamps, Towel109
 Clamps, Umbilical523
 Clamps, Vascular377-381, 384-387
 Clamps, Vascular, Pediatric386, 387
 Clayman Intraocular Lens Forceps250
 Cleft Palate Elevators351
 Clip Applying Forceps136, 137, 424
 Clip Removing Forceps136, 137
 Clips, Vessel223, 224, 430
 Clips, Wound135
 Cloward Pituitary Rongeurs422
 Coakley Antrum Curettes297
 Coakley Antrum Trocar298
 Coarctation Clamps377, 404
 Colibri Forceps75, 77, 243, 245
 Coller Forceps93
 Collie Needle Holder112, 340
 Collin Dynamometer3
 Collin Intestinal Forceps208
 Collin Retractors177
 Collin Tongue Seizing Forceps5, 350
 Collin Uterine Elevating Forceps505
 Collin Vaginal Specula491
 Collin (Judd Demartel) Gall Bladder
 Forceps204
 Collin-Duval Tissue Forceps209, 401
 Collyer Pelvimeter517
 Colon Clamps214
 Columbia Lip Retractor162, 347
 Colver Tonsil Retractor163, 358
 Colver Tonsil Seizing Forceps355
 Combo Neuro-Diagnostic Sets1
 Comedone Extractors547, 548
 Common Duct Dilators199
 Common Duct Scoops200
 Conjunctival Scissors32, 257
 Converse Alar Retractor311
 Converse Bistouri307
 Converse Blade Retractors157, 313
 Converse Nasal Scissors332
 Converse Needle Holders113, 341
 Converse Skin Hooks190, 309, 542
 Cook Eye Specula227
 Cook Rectal Retractor174, 470
 Cooley Needle Holders126, 407
 Cooley Pediatric Clamps384, 386, 387
 Cooley Tissue Forceps82, 374
 Cooley-Derra Clamp386
 Cooley-Satinsky Clamp387
 Cornea-Scleral Forceps238
 Corneal Dissector232
 Corneal Forceps243-245, 249
 Corneal Hooks234
 Corneal Knives232
 Corneal Scissors43, 47, 48, 260, 261
 Corneal Section Scissors46, 47, 258, 260
 Corneal Spuds232
 Cottle Bulldog Scissors337
 Cottle Cartilage Crusher317
 Cottle Chisel314
 Cottle Dorsal Scissors337
 Cottle Knife307
 Cottle Knife Guide Retractor156, 312
 Cottle Osteotomes314
 Cottle Rasp318
 Cottle Retractor156, 311, 312
 Cottle Septum Elevator308
 Cottle Septum Specula290
 Cottle Skin Elevator308
 Cottle Skin Hooks190, 191, 309, 311, 543
 Cottle Thumb Retractor156, 310
 Cottle-Kazanjan Nasal Cutting
 Forceps338
 Cotton Carrier, Rectal481
 Coupland Suction Tube148, 299

Drills, Hand 445
 Drills, Neurosurgical 409, 410
 Dubois Scissors 25, 523, 552
 Duckbill Ear Forceps 277
 Duckbill Rongeurs 416, 417, 461, 462
 Duke Trocar 198
 Dunning Elevator and Curette 296
 Duplay Uterine Tenaculum Forceps 500
 Dupuyss-Weiss Ligature Carriers... 143, 358
 Dupuyss-Weiss Needles 143
 Dura Hooks 431
 Dura Separators 431
 Dural Scissors 36, 335, 423
 Duval Lung Grasping Forceps 401
 Dynamometers, Hand 3

E

E-Z Off Knife Handles 14
 Ear Applicators 273
 Ear Curettes 274, 284
 Ear Forceps 275-277
 Ear Hooks 273
 Ear Instruments 269-288
 Ear Knives 278
 Ear Loops 274
 Ear Probes 145
 Ear Scissors 48, 49
 Ear Snare Wire 277
 Ear Snare 277
 Ear Specula 269, 270
 Ear Spoons 273
 Ear Suction Tubes 148, 149, 279, 287
 Ear Syringes 275
 Eastman Vaginal Retractors 165, 493
 Echlin Duckbill Rongeurs 416, 462
 Ekg Calipers 3
 Elevators, Bone 446
 Elevators, Cleft Palate 351
 Elevators, Endaural 287
 Elevators, Nasal 295, 296, 308
 Elevators, Neurosurgical 434
 Elevators,
 Periosteal 268, 308, 351, 434, 454, 455
 Elevators, Rib 388, 389
 Elevators, Septum 295, 296, 308
 Elevators, Skin 308
 Elliott Obstetrical Forceps 519

Ellis Foreign Body Spud 233
 Elsborg Cannula 425
 Elsching Fixation Forceps 246
 Elsching-O'Connor Fixation Forceps... 246
 Emmett Uterine Tenaculum
 Hooks 194, 500
 Endaural Curettes 287
 Endaural Elevators 287
 Endaural Retractors 283
 Endaural Rongeurs 287
 Endocervical Curettes 508
 Endocervical Specula 507
 Endometrial Curettes 508
 Endoscopic Forceps 366
 Engel Cast Saw 486
 Enterotomy Scissors 50
 Entropium Forceps 252, 325
 Enucleation Scissors 46, 259
 Enucleation Spoons 236
 Episiotomy Scissors 23, 516
 Eppendorfer Utering Biopsy
 Forceps 511, 512
 Erhardt Lid Forceps 252, 325
 Esmarch Bandage Shears 52
 Esmarch Cast Shears 467
 Esophageal Scissors 398
 Esophagosopic Forceps 366
 Ethmoid Curettes 297
 Ethmoid Forceps 302
 Eustachian Catheters 274
 Evans Tissue Forceps 89
 Eve Tonsil Snare 360
 Evisceration Spoons 236
 Ewald Dressing Forceps 69
 Ewald Tissue Forceps 69
 Excavator Curettes 525
 Extra-Capsular Forceps 249, 250
 Eye Calipers 239
 Eye Curettes 236
 Eye Dressing Forceps 64, 74, 241, 243
 Eye Hooks 234, 235
 Eye Magnals 233
 Eye Needles 232, 234
 Eye Scissors 34, 256, 330-333
 Eye Shield 268
 Eye Specula 225-228
 Eye Suture Scissors 41, 283, 333

F

Facelift Scissors 336, 337
 Fansler Operating Speculum 473
 Fansler-Ives Rectal Speculum 471
 Farabeuf Retractors 161
 Farabeuf-Lambotte Bone Holding
 Forceps 441
 Farr Wire Retractors 152
 Farrell Applicators 273, 291
 Farrior Ear Specula 270
 Faulkner Ethmoid Curette 297
 Fehland Intestinal Clamp 212
 Feilchenfeld Splinter Forceps 83
 Female Catheters 484
 Fenestrated Handle Forceps 64-65,
 68-70, 76, 82, 322-324,
 374, 427, 428, 537, 538
 Fenger Gall Duct Probe 146, 199
 Ferguson Angiotribes 107, 477
 Ferguson Gall Stone Scoops 200
 Ferguson Scissors 23, 515
 Ferguson Suction Tubes 148
 Ferguson Tenaculum Forceps 477, 501
 Ferris-Smith Pituitary Rongeurs 423
 Ferris-Smith Tissue Forceps 82, 429
 Finger Goniometer 442
 Finger Nail Drills 548
 Finger Retractors 158
 Finger Ring Cutter 546
 Finochietto Ligature Carrier 404
 Finochietto Needle Holders 118
 Finochietto Rib Spreaders 389
 Finochietto Thoracic Forceps 99, 404
 Finochietto-DeBakey Rib Spreader 389
 First Aid Shears 52
 Fisher Spoon And Needle 237
 Fisher Tonsil Knife-Dissector 358
 Fistula Scissors 27
 Fixation Forceps 77, 238, 244-246
 Fixation Hooks 188, 234, 309, 542
 Flash Autoclaving Pans 9
 Fletcher Sponge Forceps 111, 499
 Flexible Neck Retractors 154, 310, 544
 Fluoride Coated Scissors 52, 466
 Foerster Eye Dressing Forceps 74, 243
 Foerster Iris Forceps 74, 243

Foerster Sponge Forceps	110, 499	Forceps, Foreign Body	79	Forceps, Tissue	321-324, 399, 400, 476, 477, 504, 537, 538, 540, 541
Fomon Dorsal Scissors	336	Forceps, Gall Bladder	202-204	Forceps, Tongue Seizing	5, 350
Fomon Elevator	308	Forceps, Gall Duct	201, 202	Forceps, Tonsil	102, 355-357
Fomon Knife	307	Forceps, Gall Stone	205	Forceps, Towel	109
Fomon Rasps	319	Forceps, Gaiter	196	Forceps, Trachoma	253
Fomon Retractor	156, 311	Forceps, Hemostatic	90-108, 402, 430	Forceps, Traction	196
Fomon Lateral Scissors	36, 336	Forceps, Hysterectomy	513, 514	Forceps, Tube Occluding	11
Fomon Sabar Back Scissors	36, 336	Forceps, Hystestinal	206-214	Forceps, Tumor	505
Forceps Holders	8, 9	Forceps, Intraocular lens	250	Forceps, Tungsten Carbide	88, 89
Forceps, Angiotribe	107, 477	Forceps, Iris	66, 74, 75, 242-244, 540	Forceps, Turbinate	302
Forceps, Atraumatic	82, 373-387	Forceps, Jeweler	86, 87, 218, 219	Forceps, Undermining	403
Forceps, Biopsy, Bladder	486	Forceps, Kidney Stone	487	Forceps, Urethral	486
Forceps, Biopsy, Rectal	479-481	Forceps, Laryngeal	363, 364	Forceps, Uterine Artery	488
Forceps, Bone Cutting	338, 395, 553	Forceps, Lid	252, 325	Forceps, Uterine Biopsy	486, 509-512
Forceps, Bone Holding	440, 441	Forceps, Lung Grasping	401	Forceps, Uterine Dressing	498, 499
Forceps, Breast Tenaculum	501	Forceps, Membrane Puncturing	518	Forceps, Uterine Elevating	505
Forceps, Bronchoscopic	365	Forceps, Micro	69, 70, 74, 76, 78, 218-223, 427, 430	Forceps, Uterine Tenaculum	500, 501
Forceps, Bulldog Clamp Applying	406	Forceps, Mosquito	90-91, 103, 267, 326, 430	Forceps, Uterine Vulsellum	107, 502, 503
Forceps, Capsule	249, 250, 487	Forceps, Nail Pulling	550	Forceps, Utility	78, 79, 243, 247, 248
Forceps, Carb-N-Sert	88, 89	Forceps, Nasal Bone Cutting	338	Forceps, Vaginal	515
Forceps, Catheter Introducing	5	Forceps, Nasal Dressing	291-293	Ford Stethoscope	4
Forceps, Cervical Biopsy	510-512	Forceps, Nasal Polyp	300	Foreign Body Forceps	79
Forceps, Cervix Holding	499	Forceps, Obstetrical	518-522	Foreign Body Gouges	233
Forceps, Chalazion	252, 253	Forceps, Placenta	522, 523	Foreign Body Loops	233
Forceps, Cilia	79, 80, 250, 251	Forceps, Polyp Uterine	499	Foreign Body Needles	232
Forceps, Clip Applying	136, 137, 424	Forceps, Ptosis	252, 325	Foreign Body Spuds	233, 234
Forceps, Clip Removing	136, 137	Forceps, Recession	253	Foss Intestinal Clamp	212
Forceps, Colibri	75, 77, 243, 245	Forceps, Septum	300-302	Foss Resection Clamp	212
Forceps, Columella	325	Forceps, Sequestrum	442	Foss Retractors	170
Forceps, Cornea Scleral	238	Forceps, Skin Hook	194, 542	Fox Dermal Currettes	524
Forceps, Corneal	243-245, 249	Forceps, Skin Staple Removing	136	Fox Eye Shield	268
Forceps, Cystic Duct	101, 201, 202	Forceps, Splinter	83-87	Fraenkel Laryngeal Forceps	363
Forceps, Deplatory	82, 548	Forceps, Splinter, Jewelers Type	86, 87	Francis Chalazion Forceps	253
Forceps, Dressing	64-82, 220, 320-322, 406, 427-429, 498, 499, 537, 539, 541	Forceps, Sponge	110, 111, 356, 499	Frankel Head Band	3
Forceps, Ear	221, 275-277	Forceps, Staple Removing	136	Franz Retractors	180
Forceps, Endoscopic	366	Forceps, Sterilizer	8	Frazier Dura Hooks	190, 309, 431
Forceps, Entropium	252, 325	Forceps, Strabismus	244	Frazier Dura Separator	431
Forceps, Esophagosopic	366	Forceps, Strut	221, 288	Frazier Needle	425
Forceps, Ethmoid	302	Forceps, Suturing	78, 80, 88, 218, 219, 244, 247, 248, 251, 541	Frazier Retractors	186, 437
Forceps, Extra-Capsular	249, 250	Forceps, Tenaculum	477	Frazier Suction Tubes	148, 279, 299, 426
Forceps, Eye Dressing	64, 74, 241, 243, 244, 320, 539	Forceps, Tendon Pulling	458	Freer Chisels	268, 296, 313
Forceps, Fenestrated Handles	64, 65, 68-70, 76, 82, 322-324, 374, 427, 428, 537, 538	Forceps, Thoracic	399-404, 406	Freer Gouges	296, 313
Forceps, Fixation	77, 238	Forceps, Tissue	64-82, 88, 89, 220,	Freer Periosteal Elevator	268, 351, 434



Freer Submucous Knife295
 French Pattern Lacrimal Probes ...145, 240
 Friedman Rongeurs224, 287, 353
 Frisch Retractors170
 Fuchs Extra-Capsular Forceps250
 Fullon Rongeurs416

G

Gags, Mouth6, 7, 348, 349
 Gall Bladder Forceps202-204
 Gall Bladder Instruments199-205
 Gall Duct Forceps201, 202
 Gall Stone Scoops200
 Gallaher Rasps319
 Galt Skull Trephines411
 Gariand Hysterectomy Forceps96, 513
 Gauze Scissors51, 52
 Gaylor Uterine Biopsy Forceps509
 Gellhorn Uterine Biopsy Forceps509
 Gelpi Retractors173, 439, 495
 Gemini Forceps105, 203
 Gemini-Mixter Forceps105, 203, 402
 Gerald Dressing Forceps72, 429
 Gerald Tissue Forceps72, 429
 Gerzog Mallet284, 316, 453
 Gieritz Rib Shears395
 Gigli Saws413, 464
 Gigli-Strully Saws413, 464
 Gill Corneal Knife232
 Gill Iris Forceps75, 243
 Gill-Hess Iris Forceps75, 244
 Gillies Skin Hooks190, 308, 542
 Gillies-Sheehan Needle Holders ...115, 343
 Glover Bulldog Clamps375
 Glover Coarctation Clamps377
 Glover Patent Ductus Clamps377
 Gluck Rib Shears394, 552
 Goeliet Retractor163
 Goldman-Fox Scissors35, 334, 532
 Goldstein Lacrimal Sac Retractor .153, 228
 Goniometer, Finger442
 Goniotomy Knives232
 Goodell Uterine Dilators498
 Gordon Uterine Vulsellum Forceps503
 Gorney Scissors38, 337
 Gosset Retractors175
 Gouges, Bone449, 451, 452

Gouges, Lacrimal Sac268
 Gouges, Mastoid284
 Gouges, Septum296
 Graefle Cilia Forceps80, 251
 Graefle Scissors41, 140, 263, 333, 531
 Graefe Eye Dressing Forceps75, 243
 Graefe Fixation Forceps76, 244, 324
 Graefe Iris Forceps75, 76, 243, 540
 Graham Nerve Hook193, 432
 Grasping Forceps8
 Graves Vaginal Specula489
 Gray Cystic Duct Forceps101, 202
 Green Cystic Duct Forceps101, 201
 Green Fixation Forceps77, 245
 Green Needle Holder ...120, 264, 345, 535
 Green Retractor195
 Green Spatula237, 546
 Green Strabismus Hook189, 235
 Greene Uterine Curettes506
 Greg Comedone Extractor548
 Grooved Directors144
 Gross Hook And Spoon1990, 273
 Gruber Ear Specula269
 Gruenwald Bayonet Forceps73, 429
 Gruenwald Ear Forceps73, 429
 Gruenwald Nasal Forceps302
 Gum Scissors331
 Guthrie Fixation Hook ...188, 234, 309, 542
 Guttman Vaginal Speculum491
 Guyon Vessel Clamp488
 Guyton-Noyes Fixation Forceps245
 Guyton-Park Eye Specula226
 Gynecological And Obstetrical
 Instruments489-523

H

Haight Rib Spreaders390
 Hajek Antrum Rongeur303
 Hajek-Ballengier Septum Elevator296
 Halle Ethmoid Curette297
 Halle Nasal Speculum289
 Halsey Needle Holders .112, 123, 340, 534
 Halsted Mosquito
 Forceps90, 91, 267, 326, 430
 Hammer, Post Mortem553
 Handles, Knife13, 14
 Hank Uterine Dilators496

Harken Rib Spreaders391
 Harmon Fixation Forceps78, 246
 Harms Suture Forceps78, 247
 Harrington Retractors170, 392
 Harrington Scissors24, 398
 Hartman Ear Dressing Forceps276
 Hartman Ear Specula270
 Hartman Eustachian Catheters274
 Hartman Lee Mosquito Forceps91
 Hartman Mosquito Forceps ...91, 267, 326
 Hartman Nasal Forceps292
 Hartman Rongeur285, 353, 459
 Hartman Tonsil Punch361
 Hartman-Herzfeld Ear Forceps277
 Hartman-Noyes Ear Forceps277
 Hawks-Dennen Obstetrical Forceps522
 Hays Hand Retractor183, 447
 Head Band, Mirror3
 Head Extractor, Obstetrical522
 Head Mirrors3
 Heaney Hysterectomy Forceps96, 513
 Heaney Needle Holders117, 127
 Heaney Retractors164, 494
 Heaney Tissue Forceps71, 504
 Heaney Uterine Biopsy Curette508
 Heaney-Ballantine Hysterectomy
 Forceps96, 513
 Heaney-Simon Retractors165, 494
 Heath Chalazion Forceps252
 Heath Curettes236, 525
 Heath Suture Scissors39, 138, 339
 Hebra Curettes236
 Hagar Uterine Dilators496, 497
 Hegenbarth Clip Applying Forceps136
 Hemorrhoidal Ligator475
 Hemostatic Forceps90-108, 402, 430
 Hennig Cast Spreader468
 Hercules Cast Shears467
 Hercules Heavy Duty Scissors51
 Herrick Kidney Pedicle Clamp488
 Herzfeld Ear Forceps277
 Heyman Nasal Scissors49, 294
 Hibbs Chisels450
 Hibbs Gouges451
 Hibbs Osteotomes450
 Hibbs Retractors182, 393
 Hibbs Spinal Fusion Curettes436

Kidney Clamps	488		
Kidney Stone Forceps	487		
Kieland Obstetrical Forceps	520		
Kieland-Luikart Obstetrical Forceps	520		
Killian Antrum Cannula	299		
Killian Septum Forceps	300		
Killian Septum Specula	290		
Kirby Cornea-Scleral Forceps	238		
Kirby Fixation Forceps	238		
Kirby Hook And Expressor	238		
Kirby Iris Forceps	74, 238		
Kirschner Wires	445		
Kleinert-Kutz Bone Cutting Forceps	338		
Kleinert-Kutz Hooks	190, 309, 542		
Kleinert-Kutz Rongeurs	460		
Kleinert-Kutz Scissors	35, 335, 530		
Knapp Cataract Knife	231		
Knapp Eye Speculum	225		
Knapp Iris Scissors	32, 256, 330, 529		
Knapp Knife Needle	232		
Knapp Retractors	155, 229, 310, 544		
Knife Guides	156, 312		
Knife Handles	13, 14		
Knife Needles	232		
Knight Nasal Forceps	293		
Knight Nasal Scissors	49, 294		
Knight Septum Forceps	300		
Knives, Abscess	527		
Knives, Amputating	465		
Knives, Brain	552		
Knives, Button End	307		
Knives, Cartilage	457		
Knives, Cataract	231		
Knives, Ear	278		
Knives, Meniscus	457		
Knives, Nasal	295, 307		
Knives, Plaster	466		
Knives, Septum	295		
Knives, Tonsil	358		
Knowles Bandage Scissors	51		
Kocher Hemostatic Forceps	92, 104		
Kocher Intestinal Forceps	211		
Kogan Endocervical Specula	507		
Kollmann Dilators	485		
Krause Laryngeal Tips	364		
Krause Nasal Snare	294		
Krause Uterine Biopsy Forceps	512		
		L	
Laborde Trachea Dilator	369		
Lacrimal Dilators	240		
Lacrimal Probes	145		
Lacrimal Sac Chisels	268		
Lacrimal Sac Gouges	268		
Lacrimal Sac Retractors	228, 229		
Lacrimal Trephines	268		
Laforce Adenotomes	305		
LaGrange Scissors	35, 257, 334, 532		
Lahey Forceps	92, 100, 196, 197, 201		
Lahey Gall Duct Forceps	100, 201		
Lahey Gouger Scissors	196		
Lahey Hemostatic Forceps	100, 197		
Lahey Ligature Carriers	143, 196		
Lahey Retractor	154, 195		
Lahey Traction Forceps	196		
Lambert Chalazion Forceps	252		
Lambert-Kay Aortic Clamp	379		
Lambert-Lowman Bone Clamps	442		
Lambotte Bone Holding Forceps	441		
Lambotte Osteotomes	451		
Lamina Spreaders	173, 439		
Laminectomy Retractors	437-439		
Lancaster Eye Speculum	225		
Lane Bone Holding Forceps	440		
Lange Eye Speculum	225		
Langenbeck Elevators	434, 454		
Langenbeck Metacarpal Saw	465		
Langenbeck Retractors	164		
Larry Rectal Probe	144, 474		
Laryngeal Applicator	363		
Laryngeal Extension Cannula	364		
Laryngeal Forceps	363, 364		
Laryngeal Instruments	362-364		
Laryngeal Mirrors	362		
Laryngeal Tips	364		
Laryngectomy Tubes	372		
Lateral Vaginal Retractor	187, 507		
Lathbury Applicators	273, 291		
Lebsche Sternum Knife	396		
Lee Bronchus Clamp	377		
Lee Hartman Mosquito Forceps	91		
Lefort Urethral Sounds	483		
Leksell Rongeurs	397, 415, 461		
Lempert Currettes	287		
Lempert Elevators	287		
Lempert Rongeurs	286		
Lens Loop	235		
Lerner Skin Hook Forceps	194, 542		
Lester Fixation Forceps	77, 246		
Lewin Bone Holding Forceps	441		
Lewis Laryngectomy Tubes	372		
Lewis Lens Loops	235		
Lewis Rasps	319		
Lewis Septum Forceps	300		
Lewis Tonsil Screw	358		
Lichtwicz Antrum Needle	298		
Lid Forceps	252, 325		
Lid Plate	229		
Lid Retractors	154, 229, 546		
Life Saving Tubes	369		
Ligature Carriers	142, 143, 404		
Lilly Dissecting Scissors	28		
Lilly Tonsil Scissors	359		
Lindner Cyclodolysis Spatula And Spoon	237		
Lip Retractor	162, 347		
Lister Bandage Scissors	51		
Liston Amputating Knives	465		
Liston Bone Cutting Forceps	462		
Littauer Cilia Forceps	79, 250		
Littauer Dressing Forceps	276		
Littauer Nasal Forceps	292		
Littauer Stitch Scissors	39, 138, 139, 332, 333, 533		
Littauer-Liston Bone Cutting Forceps	462		
Little Joker Elevator	434		
Little Retractor	154		
Littler Suture Carrying Scissors	41, 140, 333		
Lobectomy Scissors	398		
Locke Elevators	546		
Locklin Scissors	27		
Lockwood Tissue Forceps	207, 400		
Lockwood-Allis Tissue Forceps	206		
Long Hysterectomy Forceps	97, 514		
Long Slit Scissors	40, 139, 351		
Loops, Ear	274		
Loma Towel Clamps	109		
Lofthrop Uvula Retractor	155, 304		
Love Nerve Retractors	159, 313, 433		
Love Uvula Retractors	155, 304		
Love-Gruenwald Pituitary Rongeurs	421		

- Love-Kerrison Cervical Rongeurs 419
 Lovelace Hemostatic Forceps 93, 197
 Lovelace Gall Bladder Forceps 103, 203
 Lovelace Lung Grasping Forceps 401
 Lowe-Breck Cartilage Knife 457
 Lower Gall Duct Forceps 100, 201
 Lower Lateral Scissors 336
 Lowman Bone Clamps 442
 Lowman-Hoglund Bone Clamps 442
 Luc Septum Forceps 301
 Lucae Dressing Forceps 81
 Lucae Ear Forceps 275
 Lucae Mallet 284, 316, 453
 Luer Rongeurs 414, 459
 Luer S-Shape Retractor 158
 Luikart Obstetrical Forceps 520
 Lukens Trachea Retractor 160, 312, 367
 Lung Grasping Forceps 401
 Lung Retractor 171, 394
- M**
- M.G.H. Needle Holders 116
 M.G.H. Vulsellum Forceps 503
 Magill Catheter Forceps 5
 Magnifying Loupe 4
 Maier Uterine Dressing Forceps 489
 Mailk Cystic Duct Catheter Clamp 204
 Mallets, Bone 453
 Mallets, Mastoid 284, 285
 Mallets, Plastic Surgery 316
 Maltz Cartilage Knife 457
 Maltz Rasps 318, 319
 Manhattan Eye And Ear Suturing
 Forceps 248
 Martin Cartilage Clamps 458
 Martin Cartilage Scissors 25, 458
 Martin Laryngectomy Tubes 372
 Martin Pelvimeter 517
 Martin Tissue Forceps 71, 324, 504
 Martini Bone Curette 318, 457
 Masson Needle Holders 115, 125
 Masson-Judd Retractors 174, 486
 Mastlin Muscle Clamp 197
 Mastoid Chisels 284
 Mastoid Curettes 284
 Mastoid Gouges 284
 Mastoid Mallets 284, 285
- Mastoid Retractors 280
 Mastoid Rongeurs 285, 286
 Mastoid Searcher 273
 Mathieu Needle Holders . 14, 124, 342, 535
 Mathieu Retractors 159, 195, 312, 368, 545
 Mathieu Urethral Forceps 486
 Matson Rib Stripper-Elevator 388
 Matson-Alexander Rib Elevator-
 Stripper 388
 Maumenee-Park Eye Speculum 226
 Maunder Oral Screw 5, 350
 Maxillo-Facial Instruments 143, 338
 Mayo-Collins Retractor 163
 Mayo Common Duct Probes 146, 199
 Mayo Common Duct Scoops 200
 Mayo Dissecting Scissors 20, 21
 Mayo Gall Stone Scoop 200
 Mayo Operating Scissors 20
 Mayo Retractors 171
 Mayo Russian Tissue Forceps 73, 399, 504
 Mayo Uterine Scissors 516
 Mayo Vessel Clamp 488
 Mayo-Adams Retractors 172
 Mayo-Harrington Scissors 398
 Mayo-Hegar Needle
 Holders 115, 125, 130, 342
 Mayo-Noble Dissecting Scissors 22
 Mayo-Robson Intestinal Forceps .. 105, 211
 McClure Iris Scissors 33, 260
 McCrea Infant Sounds 483
 McCullough Suturing Forceps 78, 248
 McCullough Utility Forceps 78, 247
 McGannon Retractor 155, 235, 310, 544
 McGivney Grasping Forceps 475
 McGivney Hemorrhoidal Ligator 475
 McGuire Corneal Scissors 47, 261
 McIvor Mouth Gag 7, 349
 McKenty Septum Elevator 308
 McKenzie Clip Forceps 137, 424
 McKenzie Clip Rack 135, 424
 McKenzie Enlarging Bur 409
 McKenzie Perforator Drill 409
 McKinney Eye Speculum 227
 McLean Obstetrical Forceps 520
 McLean-Luikart Obstetrical Forceps ... 520
 McLean-Tuckert-Luikart Obstetrical
 Forceps 520
- McPherson Corneal Suturing Forceps .244
 McPherson Needle Holder ... 121, 265, 346
 McPherson Suturing Forceps .78, 220, 247
 McPherson Tissue Forceps 76
 McPherson-Vannas Iris
 Scissors 33, 44, 217, 262
 Mead Mallet 285, 316, 453
 Mead Rongeurs 352, 460
 Measuring Tape 4
 Mechanical Finger 276
 Meller Lacrimal Sac Retractor 153, 228
 Mellingier Eye Specula 228
 Meltzer Adenoid Punch 306
 Menghini Biopsy Needles 198
 Meniscus Knives 457
 Metzzenbaum Needle Holders 116
 Metzzenbaum Scissors 24, 334, 359, 532
 Meyerding Finger Retractors 160, 312
 Meyerding Retractors ... 168, 312, 368, 438
 Meyerding Self-Retaining Retractors ... 185
 Meyerding Skin Hook 188
 Meyerding Skin Retractors ... 160, 312, 368
 Meyhofer Curettes 236
 Michel Clip Applying Forceps 136
 Michel Wound Clips 135
 Michele Trephines 413
 Micro Adson Dressing
 Forceps 69, 220, 322, 427
 Micro Adson Tissue
 Forceps 70, 220, 323, 427
 Micro Bulldog Clamps 108, 224, 267
 Micro Clip Approximator 223
 Micro Dissecting Scissors 215
 Micro Ear Forceps 288
 Micro Ear Scissors 49
 Micro Forceps 69, 70, 74, 76, 78, 90
 Micro Forceps 427, 430, 537, 538, 541
 Micro Mosquito
 Forceps 90, 103, 267, 326, 430
 Micro Rongeurs 224, 353
 Micro Scissors 33, 42-44, 49, 288
 Micro Surgery
 Instruments 108, 215-224, 427, 430
 Micro Surgery Needle Holders 119, 120,
 121, 128, 129, 222, 265
 Micro Vessel Clips 223, 224
 Micro-Friedman Rongeur 224, 287, 353

- Miculicz Forceps 95, 515
 Miculicz Tonsil Hemostat 356
 Millard Thimble Hook
 Retractor 156, 191, 310
 Miller Rectal Scissors 27, 478
 Millin Capsule Forceps 487
 Millin Urethral Forceps 487
 Miltex Blepharoplasty Scissors 335
 Miltex Cannulated Pin Cutter 443, 444
 Miltex Cast Spreader 466
 Miltex Comedone Extractor 548
 Miltex Cross Action
 Retractors 152, 281, 545
 Miltex Depilatory Forceps 82, 548
 Miltex Dermal Currettes 524, 525
 Miltex Double Action Pin Cutter 444
 Miltex Hooks 191, 234, 311, 500, 543
 Miltex I.U.D. Extractor Hook 194, 500
 Miltex Mallet 285, 316, 453
 Miltex Pin Puller 142, 444
 Miltex Rhytidectomy Scissors 336
 Miltex Slitch Scissors 40, 139, 333, 533
 Miltex Tissue Twist Hook 192, 431, 542
 Miltex Undermining Forceps 403
 Miltex Uterine Tenaculum Hook 194, 500
 Miltex-Kerrison Cervical Rongeurs 420
 Miltex-Kogan Endocervical Speculum 507
 Miniature Blade Handles 14
 Mirror Handles, Laryngeal 362
 Mirrors, Laryngeal 362
 Mixer Dilating Probe 146, 199
 Mixer Forceps 98-100, 201, 202,
 205, 327, 403
 Mixer Gall Bladder Forceps 202
 Mixer Gall Duct Forceps 201
 Mixer Gall Stone Forceps 205
 Mixer Scissors 20
 Mixer Thoracic Forceps 403
 Molt Mouth Gags 7, 349
 Morrison-Hurd Dissector-
 Retractor 163, 358
 Mosher Ethmoid Curette 297
 Mosher Life Saving Tubes 369
 Mosquito Cardiovascular Clamps 402
 Mosquito Forceps 90, 91, 103, 267, 326
 Mouth Gags 6, 7, 348, 349
 Moynihan Gall Duct Forceps 100, 201
 Muldoon Lacrimal Dilator 240
 Multipurpose Clamps 361, 382, 385
 Murdoch Eye Speculum 227
 Murless Head Extractor 522
 Murphy Retractors 170, 182
 Murphy-Lane Bone Skid 454
 Muscle Clamps 197
 Museholdt Nasal Forceps 293
 Museux Uterine Vulsium
 Forceps 107, 503

N
 Nabatoff Vein Stripper 150
 Nail Nippers 549
 Nail Scissors 50, 551
 Nail Splitters 50, 550
 Nasal Applicators 291
 Nasal Bone Scissors 38, 337
 Nasal Currettes 296, 297, 304
 Nasal Elevators 295, 296, 306
 Nasal Forceps 292, 293, 300-302, 338
 Nasal Instruments 289-306
 Nasal Knives 295, 307
 Nasal Polyo Forceps 300
 Nasal Probes 144, 145, 291
 Nasal Retractors 304
 Nasal Saws 316, 317
 Nasal Scissors 49, 294, 336, 337
 Nasal Snare Wire 294
 Nasal Snares 294
 Nasal Specula 289, 300
 Nasal Suction Tubes 148, 149, 239
 Nasopharyngeal Specula 305
 Needle Holders 112-130, 264-266,
 340-346, 407, 408, 487, 534-536
 Needle Holders, Micro
 Surgery 119, 120, 121, 128, 129, 222
 265, 334, 346, 408
 Needle Holders, Urethral 487
 Needle Sterilizer Rack 8, 135
 Needles, Aneurysm 425, 553
 Needles, Antrum 298
 Needles, Biopsy 198
 Needles, Eye 232, 234
 Needles, Surgical 131-134
 Neivert Knife Guide-Retractor 157, 313
 Neivert Needle Holders 113, 341
 Neivert Osteotomes 315
 Neivert-Anderson Osteotomes 315
 Nelson Scissors 398, 516
 Nerve Hooks 431, 432
 Nerve Retractors 433
 Nerve Separators 431, 432
 Neuro-Diagnostic Sets 1
 Neurological Hammers 1
 Neurological Pinwheel 3
 Neurological Instruments 409-439
 New Orleans Needle Holders 116, 126
 New's Suture Scissors 39, 138
 News Tracheal Hook 192, 367
 Noise Apparatus 271
 Northbent Slitch Scissors 99, 139, 333, 533
 Novak Endometrial Biopsy Currettes 508
 Noyes Alligator Ear Forceps 276, 293
 Noyes Iridectomy Scissors 47, 260
 Noyes Iris Scissors 32, 259, 530
 Noyes Nasal Forceps 293
 Nugent Hook 189, 234, 309
 Nugent Utility Forceps 78, 247
 Nurse's Scissors 202, 52

O
 O'Brien Fixation Forceps 246
 O'Brien Slitch
 Scissors 40, 139, 263, 333, 533
 O'Connor Hook 189, 234
 O'Connor Iris Forceps 74, 242
 O'Connor Tenotomy Hook 189, 234
 O'Sullivan-O'Connor Retractors 176
 O'Sullivan-O'Connor Vaginal
 Retractor 176, 494
 Obstetrical Forceps 518-522
 Obwegesser Awls 143, 338
 Occlusion Clamps 11
 Ochsner Gall Duct Probe 146, 199
 Ochsner Trocars 198
 Oldberg Pituitary Rongeur 422
 Ollier Retractor 172, 393, 444
 Olsen-Hegar Needle Holders 113, 124,
 341, 535
 Operating Scissors 18-50, 54-63
 Ophthalmic Instruments 225-268
 Oral Instruments 347-354
 Oral Screw 5, 350

Oral Surgery Rongeurs352-354
 Orthopedic Instruments440-465
 Osteotomes, Orthopedic449-452
 Osteotomes, Plastic Surgery314, 315
 Otis Urathrolome485
 Otcoscopes270, 271

P

Packer Mosquito Forceps90
 Parker Mott Retractors164
 Parker Retractors161
 Patent Ductus Clamps377, 378
 Paton Needle Holders ..121, 264, 346, 536
 Patterson Trocars198
 Payr Pylorus Clamps214
 Pean Forceps97, 211
 Pean Hysterectomy Forceps514
 Pederson Vaginal Specula490
 Pediatric Vascular Clamps384-387
 Pedicle Clamps98, 487, 515
 Peet Splinter Forceps85
 Pelvimeters517
 Pencil-Type Micro Forceps215
 Pencil-Type Micro Scissors42, 215
 Penfield Dissectors435
 Pennington Forceps102, 476
 Pennington Rectal Speculum471
 Pennington Septum Elevator296
 Percussion Hammers1
 Percy Intestinal Forceps208
 Perineal Retractors495
 Periosteal Elevators268, 308, 351, 388,
 Periosteal Elevators389, 434, 454, 455
 Periosteotomes398
 Peripheral Vascular Clamps378
 Peritoneal Clamp515
 Perkins Endaural Retractor185, 283
 Phaneuf Uterine Artery Forceps97, 514
 Physicians Splinter Forceps84
 Pierce Antrum Trocar298
 Pierce Elevator295
 Pierce Colibri Corneal Forceps77, 245
 Piffard Dermal Curettes524
 Pillar Retractors162, 358
 Pin Cutters443, 444
 Pinard Stethoscope517
 Piper Obstetrical Forceps519

Plain Wire Eye Speculum226, 227
 Plaster Knives466
 Plaster Saws466
 Plaster Shears51-53, 466, 467
 Plastic Surgery Calipers317
 Plastic Surgery Curettes318
 Plastic Surgery Instruments307-346
 Plastic Surgery Mallets316
 Plastic Surgery Rasps318, 319
 Plastic Surgery Scissors ..29, 328-337, 339
 Platypus Nail Forceps550
 Pliers, Wire Cutting142, 443
 Polizer Ear Knives278
 Polk Finger Goniometer442
 Polyp Forceps, Uterine499
 Poole Suction Tubes148
 Post Mortem Hammer553
 Post Mortem Instruments552, 553
 Potts-Smith Dressing Forceps ..71, 89, 406
 Potts-Smith Scissors26, 405
 Potts-Smith Tissue Forceps72, 406
 Pratt Crypt Hooks193
 Pratt Ethmoid Curette297
 Pratt Rectal Probe146, 474
 Pratt Rectal Scissors478
 Pratt Rectal Speculum469
 Pratt T-Shape Forceps94, 208, 476
 Pratt Uterine Dilators497
 Presbyterian Hosp. Occluding Clamp12
 Prince Forceps325
 Prince Trachoma Forceps253
 Probes, Ear145, 273
 Probes, General Operating144-146
 Probes, Lacrimal145
 Probes, Nasal144, 145, 291
 Probes, Rectal144, 146, 474
 Probes, Sinus145
 Proctoscopes473
 Providence Hospital Forceps ..91, 196, 326
 Ptosis Forceps252, 325
 Pudendal Needle Guide523
 Punctures, Adenoid306
 Punctures, Corneoscleral262
 Punctures, Dermal526
 Punctures, Dermal Disposable526
 Punctures, Tonsil361
 Putti Bone Rasps454

Pylorus Clamps214
 Pylorus Separator213
 Pynchon Suction Tubes ...6, 147, 350, 357

Q

Quick Release Needle Holders130
 Quimby Scissors36, 335
 Quire Mechanical Finger276

R

Rabiner Neuro Hammer1
 Rack For Surgical Needles8, 135
 Rack, Clip Holding135, 424
 Ragnell Dissecting Scissors ...30, 334, 532
 Ragnell Retractor158, 312, 368
 Rake Retractors154, 155, 310, 544
 Randall Endometrial Biopsy Curette ...508
 Randall Kidney Stone Forceps487
 Raney Scalp Clip Forceps143, 424
 Raney Scalp Clips143, 424
 Raney-Crutchfield Skull Tong411
 Rankin Forceps93
 Raspatories, Rib388
 Rasps, Antrum297
 Rasps, Plastic Surgery318, 319
 Recession Forceps253
 Rectal Cotton Carrier481
 Rectal Instruments469-481
 Rectal Probes144-146, 474
 Rectal Scissors478
 Rectal Specula469-473
 Reiner Cast Knife466
 Reiner Rongeur459
 Remover, Blade15
 Renal Clamps488
 Retractors, Anal174, 175, 469
 Retractors, Appendectomy173
 Retractors, Bladder174, 486
 Retractors, Bone446-448
 Retractors, Cerebellar412
 Retractors, Decompression161, 432
 Retractors, Endaural283
 Retractors, Gall Bladder170
 Retractors, General Operating151-167,
 446-448
 Retractors, Hyslerectomy494
 Retractors, Lacrimal Sac228, 229

- Retractors, Laminectomy 173, 437-439
 Retractors, Lid 154, 229, 546
 Retractors, Lung 171, 394
 Retractors, Mastoid 280
 Retractors, Nasal 304
 Retractors, Nerve 432
 Retractors, Nerve Root 159, 313, 433
 Retractors, Perineal 495
 Retractors, Pillar 162, 358
 Retractors, Rectal 172, 174, 175, 470
 Retractors, Scalp 411, 412
 Retractors, Scapula 171, 391, 394
 Retractors, Spinal 171, 412
 Retractors, Splanchnic 392
 Retractors, Thoracic 392-394
 Retractors, Tonsil 358
 Retractors, Tracheal 160, 367, 368
 Retractors, Uvula 304
 Retractors, Vaginal 176, 187, 493-495, 507
 Retractors, Vein 432
 Reynolds Dissecting Scissors 23, 335, 405
 Rhoton Micro Forceps 74, 219
 Rhytidectomy Scissors 36, 336
 Rib Elevators 388
 Rib Shears 394, 395, 552, 553
 Rib Spreaders 389-391
 Rib Strippers 388
 Ribbon Retractors 163
 Richardson Retractors 168, 393
 Richardson-Eastman Retractors 169
 Richter Dissecting Scissors 50, 552
 Richter-Heath Clip Forceps 137
 Rigby Retractors 173, 495
 Ring Tongue Retractor Blades 6
 Rochester Gall Stone Forceps 205
 Rochester Pean Forceps 94
 Rochester-Carmalt Forceps 95
 Rochester-Ochsner Forceps 95
 Roeder Towel Clamp 109
 Roger Septum Elevator 295
 Rollet Retractor 155, 310, 544
 Rongeurs, Antrum 303
 Rongeurs, Bone 459-462
 Rongeurs, Duckbill 416, 417, 461, 462
 Rongeurs, Endaural 286
 Rongeurs, Mastoid 285, 286
 Rongeurs, Neurosurgical 414-423
 Rongeurs, Oral Surgery 352-354
 Rongeurs, Thoracic 396, 397
 Ronis Adenoid Punches 306
 Rosser Crypt Hook 194, 474
 Roux Retractors 164
 Rowland Nasal Hump Forceps 338
 Rubin Septal Morselizer 301
 Ruedemann Lacrimal Dilator 240
 Ruler, Flexible 239, 546
 Rumel Thoracic Forceps 106, 402
 Ruskin Antrum Needles 298
 Ruskin Bone Cutting
 Forceps 338, 395, 463
 Ruskin Rongeurs 286, 397, 415, 460
 Russian Tissue Forceps 71, 399, 504
 Ryder Needle Holders .. 126, 128, 407, 408
- S**
- Saalfeld Comedone Extractors 547
 Saber Back Scissors 336
 Sachs Nerve Separator 432
 Sage Tonsil Snare 360
 Sarot Artery Forceps 108, 402
 Sarot Bronchus Clamps 404
 Sarot Needle Holders .. 117, 127, 343, 408
 Satinsky Clamps 404
 Satinsky Scissors 27, 406
 Satinsky-DeBaKey Clamps 384
 Satterlee Bone Saw 465
 Sauer Eye Speculum 227
 Sauer Suturing Forceps 248
 Sauerbruch Bone Rongeurs 397
 Sauerbruch Retractors 161, 393
 Saws, Bone 465
 Saws, Cast 466
 Saws, Nasal 316, 317
 Saws, Wire 413, 464
 Sawtell Tonsil Hemostats 102, 357
 Sawyer Rectal Retractors 172, 470
 Sayre Elevators 455
 Scalp Retractors 411, 412
 Scalpel Blades 15-17
 Scalpel Handles 13-14
 Scapula Retractor 391
 Schaaaf Foreign Body Forceps 79, 248
 Schambaugh Adenotomes 305
 Schamberg Comedone Extractors 547
 Scheie-Westcott Corneal Section
 Scissors 46, 259
 Schink Retractor 184
 Schiotz Tonometers 230
 Schlesinger Cervical Rongeurs 418
 Schlesinger Pituitary Rongeurs 422
 Schmidt Tonsil Hemostats 102, 356
 Schroeder Uterine Vulsellum Forceps .. 502
 Schroeder-Braun-Tenaculum Forceps 500
 Schubert Uterine Biopsy Forceps 509
 Schuhknecht Endaural Retractors 185, 283
 Schwartz Vessel Clips 224, 430
 Schwartz Clip Applying Forceps .. 224, 430
 Schweiger Extra-Capsular Forceps 249
 Scissors, Abdominal 23
 Scissors, Bandage 51, 52
 Scissors, Blepharoplasty 59, 335, 531
 Scissors, Brophy 35, 331, 351
 Scissors, Bulldog 37, 337
 Scissors, Capsulotomy 48, 262
 Scissors, Carb-N-Sert 54-59
 Scissors, Cardiovascular 26, 405
 Scissors, Cartilage 25
 Scissors, Conjunctival 32, 257
 Scissors, Corneal 43, 47, 48, 260, 261
 Scissors, Corneal
 Section 46, 47, 258, 260
 Scissors, Cuticle 50
 Scissors, Debridement 35, 532
 Scissors, Decapitation 523
 Scissors, Dermal 36, 528-533
 Scissors, Dissecting 20-23, 28, 30; 42,
 50, 334, 335, 398, 405, 532, 552
 Scissors, Dorsal 37, 336, 337
 Scissors, Dural 36, 335, 423
 Scissors, Ear 48, 49
 Scissors, Enterotomy 50, 552
 Scissors, Enucleation 46, 259
 Scissors, Episiotomy 23, 516
 Scissors, Esophageal 398
 Scissors, Eye 34, 41
 Scissors, Facelift 37, 336, 337
 Scissors, Fistula 27
 Scissors, Gall Bladder 205
 Scissors, Gauze 51, 52
 Scissors, Gum 331
 Scissors, Iridectomy 260

- Scissors, Iris 30-33, 44, 254-256,
 259, 260, 262, 329, 330, 527-530
- Scissors, Keratoplasty 47
- Scissors, Lobectomy 398
- Scissors, Lower Lateral 36, 336
- Scissors, Micro 33, 44, 49, 288
- Scissors, Nail 50, 551
- Scissors, Nasal 38, 49, 294, 336, 337
- Scissors, Nasal Bone 38
- Scissors, Neurosurgical 423
- Scissors, Operating 18-50, 54-63
- Scissors, Plastic Surgery 29, 328-337, 339
- Scissors, Rectal 478
- Scissors, Rhytidectomy 36, 336
- Scissors, Saber Back 36, 336
- Scissors, Septal 38
- Scissors, SerrateX 19, 21
- Scissors, Stitch 39, 40, 138-140, 258,
 263, 332, 333, 351, 533
- Scissors, Strabismus 34, 257, 529
- Scissors, SuperCut 60-63
- Scissors, Suture 39-41, 138-140, 258
- Scissors, Suture Carrying 41, 140, 333
- Scissors, Tenotomy 35, 45, 46, 257, 258,
 331, 332, 335, 530
- Scissors, Tonsil 355, 359
- Scissors, Tungsten Carbide 54-59
- Scissors, Turbinate 49
- Scissors, Umbilical 23, 523
- Scissors, Undermining 36, 334, 531, 532
- Scissors, Uterine 415, 516
- Scissors, Utility 31, 32, 46, 52, 255,
 257, 258, 332, 529
- Scissors, Wire Cutting 40, 41, 141, 339
- Scissors, Wound Debridement 35
- Scoops, Common Duct 200
- Scoops, Gall Stone 200
- Scoville Spatula 425
- Scoville Clip Forceps 137, 424
- Scoville Disc Curettes 436
- Scoville Nerve Retractors 159, 433
- Screw, Tonsil 358
- Scudder Intestinal Forceps 105, 211
- Sedillot Periosteal Elevator 389, 454
- Seiler Turbinate Scissors 49, 294
- Seldin Periosteal Elevator 308
- Seitzer Dermal Hook 194, 234, 311, 542
- Semken Dressing Forceps 67, 322,
- Semken Dressing Forceps 428, 537
- Semken Tissue Forceps 67, 322, 428, 537
- Senn Retractors 158, 195, 312, 368, 456
- Septal Morselizer 301
- Septum Elevators 295, 296, 308
- Septum Forceps 300-302
- Septum Gouges 296
- Septum Knives 295
- Septum Scissors 36, 337
- Septum Specula 290
- Septum Straighteners 338
- SerrateX Operating Scissors 19
- Serralex-Mayo Scissors 21
- Serrefines 108, 267, 327
- Sexton Ear Knives 278
- Shallcross Cystic Duct Forceps 101, 203
- Shapleigh Ear Curettes 274
- Sheehan Osteotomes 314
- Sheehan-Gillies Needle Holders 115, 343
- Shepard Intraocular Lens Forceps 250
- Shorfbent Stitch Scissors 39, 138,
 263, 332, 533
- Siegel Knife Handle 14
- Siegel Otoscope 271
- Silver Osteotomes 315
- Simpson Obstetrical Forceps 518
- Simpson Uterine Sound 498
- Simpson-Luikart Obstetrical Forceps 520
- Sims Rectal Speculum 469
- Sims Scissors 25, 516
- Sims Uterine Biopsy Curette 508
- Sims Uterine Curettes 506
- Sims Uterine Sound 498
- Sims Vaginal Specula 492
- Single Tissue Forceps 73, 209, 399
- Sinus Cannula 298
- Sinus Probes 145
- Sistrunk Scissors 22, 336
- Skeele Curettes 236, 525
- Skene Uterine Tenaculum Forceps 501
- Skene Uterine Vulsellum Forceps 503
- Skillem Sinus Probe 145, 291
- Skin Elevators 308
- Skin Hook Forceps 194, 542
- Skin Hooks 188-192, 194, 309-311,
 542, 543
- Skin Staple Removing Forceps 136
- Skull Traction Tong 411
- Skull Trephines 411
- Smillie Meniscus Knives 457
- Smillie Meniscus Hook Retractor 183, 446
- Smith (Bulie) Anal Retractors 175, 470
- Smith Eye Speculum 227
- Smith-Fisher Iris Spatula 237
- Smith-Petersen Gouges 452
- Smith-Petersen Osteotomes 451
- Smith-Petersen Rongeurs 416
- Smithwick Clip Forceps 137, 424
- Smithwick Nerve Hook 193, 432
- Smithwick Sympallectomy Hook 193, 432
- Snare Wire, Ear 277
- Snare Wire, Nasal 294
- Snares, Ear 277
- Snares, Nasal 294
- Snares, Tonsil 360, 361
- Snellen Entropion Forceps 252, 325
- Somer Uterine Elevating Forceps 505
- Sonnenschein Nasal Speculum 289
- Sounds, Urethral 482, 483
- Sounds, Uterine 498
- Spatula, Brain 425
- Spatula, Iris 237
- Specula, Ear 269, 270
- Specula, Endocervical 507
- Specula, Eye 225-228
- Specula, Nasal 289, 290, 313
- Specula, Nasopharyngeal 305
- Specula, Rectal 469-473
- Specula, Septum 290
- Specula, Vaginal 489-492
- Spencer Chalazion Forceps 253
- Spencer Ear Probes 145, 273
- Spencer Stitch Scissors 39, 138, 263,
 332, 533
- Sphenoid Cannula 299
- Sphincteroscopes 472
- Spinal Retractors 412
- Splanchnik Retractors 392
- Splinter Forceps 83-87
- Splinter Forceps With Magnifier 84
- Splinter Liberator 85
- Splinter Removal Kit 85
- Spitters, Nail 550

Sponge Holding Forceps	110, 111,	Strabismus Hooks	189	Tenaculum, Dissecting	553
.....	356, 499	Strabismus Scissors	34, 257, 331, 529	Tendon Pulling Forceps	458
Spoon And Spatula, Cycloclialysis		Stratte Needle Holders	117, 127, 487	Tendon Strippers	458
Spoons, Ear	273	Struempel Ear Forceps	277	Tenotomy Hooks	189
Spoons, Enucleation	236	Struilly Scissors	28, 423	Tenotomy Scissors	35, 45, 46, 257, 258,
Spoons, Evisceration	236	Strut forceps	221, 221, 228	331, 332, 335
Spratt Bone Curettes	436, 456	Struyken Turbinate Forceps	302	Theobald Sinus Probe	145, 591
Spratt Mastoid Currettes	284	Suction Tubes, Ear	148, 149	Thomas Uterine Curettes	506
Spratt Spinal Fusion Curettes	436	Suction Tubes, General Operating	5, 6,	Thoms-Aillis Tissue Forceps	207, 476, 502
Spray Lube	11	147-149, 350, 351, 426	Thoms-Gaylor Uterine Biopsy Forceps	509
Spring Wire Retractors	152	Suction Tubes, Nasal	148, 149, 299	Thoracic And Cardiovascular	
Spurling Pituitary Rongeurs	421	Suction Tubes, Rectal	149, 481	Instruments	368-408
Spurling-Kerrison Cervical Rongeurs	419	SuperCut Scissors	60-63	Thoracic Clamps	404
St. Vincents Tube Occluding Forceps	11	Surgi-Guide Template	317	Thoracic Forceps	399-404, 406
Staple Removing Forceps	136	Surgical Blades	15-17	Thoracic Tissue Forceps	399, 406
Staude-Moore Tenaculum Forceps	501	Surgical Instrument Cleaner	11	Thorex Scissors	25, 205, 398
Steiner-Auvard Vaginal Speculum	492	Surgical Instrument Stain Remover	11	Thorpe Caliper	239, 317
Sterilizer Forceps	8	Surgical Needle Rack	8, 135	Thorpe Corneal And Splinter	
Sterilizer Rack For Needles	8	Surgical Needles	131-134	Forceps	87, 249
Sterilizing Aids	8-10	Suture Carrying Scissors	41, 140, 333	Thyroid-Goiter Instruments	195-197
Sterilizing Trays	9, 10	Suture Needles	131-134	Tieck-Halle Nasal Speculum	289
Sternum Knife	396	Suture Scissors	39-41, 138-140, 258, 263	Tischler Cervical Biopsy Punch	
Stethoscope	4	Suture Sundries	135-143	Forceps	510, 512
Stethoscopes, Obstetrical	517	Suture Wire	135	Tissue Forceps	64-82, 88, 89, 321-324,
Stevens Iris Forceps	75, 243	Suturing Forceps	78, 88, 244, 247,	399, 400, 427-429, 476, 477,
Stevens Needle Holder	121, 265	248, 251, 541	504, 537, 538, 540, 541
Stevens Tenotomy Hook	189, 235	Sweet Scissors	28, 398	Tissue Nippers	550, 551
Stevens Tenotomy Scissors	45, 257,	Swiss Cilia And Suture Forceps	80, 138,	Tivnen Tonsil Seizing Forceps	355
.....	331, 332, 530	251, 325, 541	Tongue Depressors	347
Stevenson Lacrimal Sac Retractor	153, 228	Swiss Jeweler Forceps	218, 219	Tongue Retractor Blades	6
Stewart Crypt Hooks	193, 474	Swiss Pattern Osteotomes	452	Tongue Seizing Forceps	5, 350
Stille Cranial Drills	410, 445	Syringes, Ear	275	Tonometer Sterilizing Case	230
Stille Patt. Vessel Clamp	488			Tonometers	230
Stille Cast Shears	53, 467			Tonsil Dissectors	358
Stille Rib Shears	394, 395, 553			Tonsil Forceps	102, 355-357
Stille Tissue Forceps	69			Tonsil Instruments	355-361
Stille-Honstley Bone Cutting				Tonsil Knives	358
Forceps	395, 463			Tonsil Punches	361
Stille-Liston Bone Cutting				Tonsil Retractors	358
Forceps	395, 463			Tonsil Scissors	355, 359
Stille-Luer Rongeurs	396, 417, 461			Tonsil Screw	358
Stitch Scissors	39, 40, 138-140, 258,			Tonsil Snare Wire	360, 361
.....	263, 332, 333, 351, 533			Tonsil Snares	360, 361
Stone Intestinal Clamps	213			Tooke Corneal Knife	232
Stone Tissue Forceps	71			Towel Clamps	109
Stoekey Rongeur	414			Townsend Cervical Biopsy Punch	
Strabismus Forceps	76, 244			Forceps	510

T

T-C Carb-N-Sert Dressing	
And Tissue Forceps	88, 89
T-C Carb-N-Sert Needle	
Holders	122-130, 222, 266
T-C Carb-N-Sert Scissors	54-59
Takahashi Ethmoid Forceps	302
Tape Measure	4
Taylor Dural Scissors	36, 335, 423
Taylor Percussion Hammers	1
Taylor Spinal Retractor	171, 412
Teale Uterine Vulsellum Forceps	502
Tenaculum Forceps, Breast	501
Tenaculum Forceps, Uterine	500, 501



Toynbee Ear Specula	269
Trachea Tube Brushes	372
Trachea Tubes	371, 372
Tracheal Bistouri	369
Tracheal Dilators	369
Tracheal Hooks	367, 368
Tracheal Instruments	367-372
Tracheal Retractors	367, 368
Trachoma Forceps	253
Trays, Sterilizing	9, 10
Trephines, Lacrimal	268
Trephines, Neurosurgical	411, 413
Trocars	198, 298
Trommer Percussion Hammer	1
Trousseau Trachea Dilators	369
Trouman-Barraquer Blade Breaker	231
Trouman-Barraquer Colibri Forceps	75, 243
Trouman-Barraquer Corneal Forceps	75, 243
Tube, Life Saving	369
Tube Occluding Clamps	12
Tubes, Laryngectomy	372
Tubing Clamps	12
Tuffier Retractor	186, 437
Tuffier Rib Spreaders	391
Tumor Forceps	505
Tumor Screw	505
Tungsten Carbide Dressing Forceps 88, 89	
Tungsten Carbide Needle Holders	122-130, 222, 266
Tungsten Carbide Scissors	54-59
Tungsten Carbide Tissue Forceps	88, 89
Tuning Forks	2, 272
Turbinate Forceps	302
Turbinate Scissors	49
Turrell Biopsy Forceps	480
Tuttle Tissue Forceps	399
Twist Drills, Neurosurgical	410, 445
Twist Hook, Tissue	192, 431, 542
Tyding Tonsil Snare	361
Tyrell Hooks	188, 234, 309, 542
U	
U.S. Army Chisels	449
U.S. Army Gouges	449
U.S. Army Osteotomes	449
U.S. Army Retractors	163

U.S. Patt. Cast Knife	466
U.S.A. Gauze Scissors	51
Uebe Applicators	273, 291
Umbilical Clamps	523
Umbilical Scissors	23, 523
Undermining Forceps	403
Undermining Scissors	38, 334, 531, 532
Universal Handle	364
Universal Laryngeal Tips	364
University of Minnesota Cheek Retractor	162, 347
Unna Comedone Extractor	547
Urethral Catheters	484
Urethral Dilators	484, 485
Urethral Forceps	486
Urethral Sounds	482, 483
Urethrotome	485
Urological Instruments	482-488
Uterine Artery Forceps	488
Uterine Biopsy Curettes	508
Uterine Biopsy Forceps	486, 509-512
Uterine Curettes	506, 507
Uterine Dilators	496-498
Uterine Dressing Forceps	498, 499
Uterine Elevating Forceps	505
Uterine Polyp Forceps	499
Uterine Scissors	515, 516
Uterine Sounds	498
Uterine Tenaculum Forceps	500, 501
Uterine Tenaculum Hooks	500
Uterine Vulsellum Forceps	107, 502, 503
Utility Forceps	78, 79, 243, 247, 248
Utility Scissors	31, 32, 46, 52, 255,
.....	258, 332, 529
Utility Shears	51-53, 466, 467
Utility-Sterilizer Forceps	8
Uvula Retractors	304

V

Vaginal Forceps	515
Vaginal Retractors	493-495, 507
Vaginal Specula	489-492
Van Alyea Antrum Cannula	298, 299
Van Alyea Sinus Cannula	298
Van Buren Sequestrum Forceps	442
Van Buren Sounds	482
Vannas Capsulotomy Scissors	48, 262

Vannas Scissors	44, 217, 262
Vascular Clamps	377-381, 384-387
Vascular Tissue Forceps	374
Vaughan Abscess Knife	527
Vein Strippers	150
Vessel Clips	223, 224, 430
Video, Instrument Care	11
Vienna Nasal Specula	289
Virchow Brain Knives	552
Virchow Skull Breaker	553
Virtus Splinter Forceps	84
Vogel Adenoid Curette	304
Volkman Finger Retractors	158
Volkman Hooks	181, 188, 447
Volkman Retractors	158, 181, 182,
.....	447, 448
Volkman Bone Curettes	318, 456
Von Eicken Antrum Cannula	299
Von Graefe Cystotome	232
Von Graefe Strabismus Hooks	189, 235
Von Graeffe Cataract Knife	231
Vulsellum Forceps, Uterine	107, 502, 503

W

Wachenfeld Clip Forceps	136
Wadsworth-Todd Cautery	239
Wagner Retractors	151, 280, 411
Waldeau Fixation Forceps	245
Walsham Septum Straighteners	338
Walter Corneal Spuds	232
Walter Splinter Forceps	83, 85
Walther Dilator-Catheters	484
Walther Urethral Sounds	483
Walton Foreign Body Gouge	233
Wangensteen Needle Holders	118, 128, 408
Wangensteen Tissue Forceps	73, 209, 399
Wartenberg Pinwheel	3
Watson-Williams Polyp Forceps	300
Webster Needle Holders	112, 123, 130,
.....	340, 534
Wecker Iris Spatula	237
Weingartner Ear Forceps	277
Weitlaner Retractors	184, 282, 438
Wells Enucleation Spoon	236
Wertheim Pedicle Clamp	98, 487, 515

Wertheim-Cullen Pedicle Clamp	98, 487, 515	Wound Clips	135
West Lacrimal Gouge	268	Wullstein Ear Forceps	288
West Lacrimal Sac Chisel	268	Wullstein Ear Scissors	48, 288
Westcott Suture Scissors	41, 140,	Wullstein Endaural Retractor	185, 283
.....	258, 333	Wylie J Vascular Clamp	383
Westcott Tenotomy Scissors ..	46, 258, 530	Y	
Westcott Utility Scissors	46, 258	Yankauer Nasopharyngeal Speculum ..	305
Wheeler Discission Knife	231	Yankauer Suction Tubes	5, 6, 147,
White Tonsil Seizing Forceps	355	351, 357
Wieder Tongue Depressors	347	Yeoman Biopsy Forceps	479, 480
Wiener Antrum Rasps	297	Young Renal Pedicle Clamp	488
Wiener Eye Speculum	227	Young Tongue Seizing Forceps	350
Wiener Hooks	189, 234, 309	Z	
Wies Chalazion Forceps	253	Zaufel-Jansen Rongeur	286, 415, 460
Wignore Cast Saw	466	Ziegler Cilia Forceps	79, 250
Wide Dressing Forceps	81, 291	Ziegler Knife Needle	232
Wilde Ear Forceps	274	Ziegler Lacrimal Dilators	240
Wilde Ethmoid Forceps	302		
Wilde Nasal Forceps	291		
Wilder Cystotome	232		
Wilder Lacrimal Dilator	240		
Wilder Lens Loops	235		
Willauer Scissors	398		
Williams Eye Specula	225		
Williams Intestinal Forceps	208		
Williams Lacrimal Probes	145, 240		
Williams Splinter Forceps	84		
Williams Tissue Forceps	400		
Willinger Bone Curette	318, 457		
Wills Hospital Utility Forceps	79, 248		
Wilmer Conjunctival And Utility Scissors	32, 257, 529		
Winter Placenta Forceps	523		
Wire Brush For Rasps And Files ...	12, 319		
Wire Cutters	444		
Wire Cutting Pliers	142, 443		
Wire Cutting Scissors	40, 41, 141, 339		
Wire Guide	143, 442		
Wire Retractors	152		
Wire Saws	413		
Wire Twisters	127, 142, 354, 443		
Wire, Suture	135		
Wire, Tonsil Snare	360, 361		
Wires, Kirschner	445		
Wittner Uterine Biopsy Forceps	511		
Wolf-Boehler Cast Breaker	468		

Numerical Index



CAT. NO.	PAGE	CAT. NO.	PAGE	CAT. NO.	PAGE
1-4	4	2-144	6, 348	4-7	13
1-200	1	2-145	6, 348	4-7R	13
1-202	1	2-146	6, 348	4-8	13
1-208	1	2-147	6, 348	4-8R	13
1-210	1	2-150	7, 348	4-9	13
1-211	1	2-154	7, 349	4-10	13
1-212	1	2-160	7, 349	4-11	13
1-213	1	2-162	7, 349	4-12	13
1-214	1	2-164	7, 349	4-16	13
1-220	1	2-180	7, 349	4-17	14
1-222	1	2-182	7, 349	4-18	14
1-226	3	3-2	8	4-20	14
1-228	3	3-4	8	4-30	14
1-240	3	3-10	8	4-31	14
1-242	3	3-14	8	4-100	15
1-243	3	3-20	8	4-110	15
1-244	3	3-22	8	4-111	15
1-3000	3	3-24	8	4-112	15
1-3005	3	3-26	8	4-112B	15
1-3015	3	3-50	8, 135	4-115	15
1-3200	4	3-60	8	4-115C	15
1-4000	4	3-70	9	4-120	15
1-4006	4	3-71	9	4-121	15
1-4010	4	3-72	9	4-122	15
2-20	5, 350	3-74	9	4-123	15
2-50	5, 204, 350	3-400	9	4-125	15
2-60	5, 350	3-401	9	4-310	16
2-62	5, 209, 350	3-402	9	4-311	16
2-70	5	3-404	9	4-312	16
2-72	5	3-405	9	4-312B	16
2-100	6, 147, 350, 357	3-499	9	4-315	16
2-104	5, 147, 350, 357	3-500	9	4-315C	16
2-104SS	5, 147, 350, 357	3-501	9	4-320	16
2-106	5, 147, 350, 357	3-502	9	4-321	16
2-106SS	5, 147, 350, 357	3-550	10	4-322	16
2-109	6, 147, 350, 357	3-552	10	4-323	16
2-110	6, 147, 351, 357	3-554	10	4-325	16
2-110SS	6, 147, 351, 357	3-570	10	4-400	14
2-120	6, 348	3-572	10	4-401	14
2-122	6, 348	3-574	10	4-410	17
2-130	6, 348	3-576	10	4-411	17
2-132	6, 348	3-620	10	4-412	17
2-132A	6, 348	3-624	10	4-415	17
2-134	6, 348	3-628	10	4-420	17
2-134A	6, 348	3-640	10	4-421	17
2-136	6, 348	3-700	11	4-422	17
2-136A	6, 348	3-720	11	4-423	17
2-138	6, 348	3-740	11	5-2	18
2-138A	6, 348	3-800	11	5-4	18
2-140	6, 348	3-810	11	5-6	18
2-141	6, 348	3-1000	11	5-6TC	55
2-142	6, 348	3-1001	11, 319	5-7	18
2-143	6, 348	3-2000	12	5-8	18



Numerical Index

CAT. NO.	PAGE	CAT. NO.	PAGE	CAT. NO.	PAGE
5-12	18	5-112	20	5-182B-TC	57
5-14	20	5-114	20	5-182TC	57
5-16	18	5-115	20	5-183	24
5-16TC	55	5-116	20	5-184	24
5-17	18	5-120	20	5-184TC	57
5-18	18	5-120TC	56	5-185	24
5-19	18	5-122	20	5-186	24, 398, 516
5-22	18	5-122TC	56	5-186TC	57
5-24	18	5-124	20	5-187	24
5-26	18	5-124TC	56	5-187TC	57
5-26TC	55	5-126	20	5-188	24, 398, 516
5-27	18	5-126TC	56	5-188TC	57
5-28	18	5-128	20, 398, 516	5-189	24
5-32	18	5-128TC	56	5-189A-TC	57
5-34	18	5-130	20, 398, 516	5-189TC	57
5-36	18	5-130TC	56	5-190	24, 398
5-36TC	55	5-132	21	5-192	24, 398
5-37	18	5-134	21	5-192TC	57
5-38	18	5-136	21	5-193	24
5-42	18	5-136TC	56	5-193A-TC	57
5-44	18	5-138	21	5-194	24, 398
5-46	18	5-138TC	56	5-196	24, 398
5-46TC	55	5-140	21	5-200	24, 398
5-48	18	5-140TC	56	5-202	24, 398
5-49	18	5-142	21	5-220	25, 516
5-52	18	5-142TC	56	5-222	25, 516
5-54	18	5-144	22	5-224	25, 516
5-56	18	5-146	22	5-226	25, 516
5-56TC	55	5-148	22	5-228	25, 516
5-58	18	5-150	22	5-230	25, 516
5-60	19	5-152	22, 336	5-243	25, 398
5-61	19	5-154	22, 336	5-244	25, 205, 398
5-62	19	5-160	23, 515	5-245	25, 205, 398
5-63	19	5-162	23, 515	5-246	26, 405
5-64	19	5-166	23, 515	5-247	26, 405
5-66	19	5-172	23, 335	5-248	26, 405
5-70	19	5-174	23	5-249A	26, 405
5-72	19	5-176	23, 335, 405	5-249B	26, 405
5-73	19	5-178	23, 405	5-249C	26, 405
5-74	19	5-179	24, 196	5-24-B	26, 405
5-76	19	5-179TC	57	5-24-C	26, 405
5-77	19	5-179A-TC	57	5-250	27, 423, 478, 516
5-80	19	5-179B-TC	57	5-252	27, 423, 478, 516
5-82	19	5-180	24, 196, 334, 532	5-254	27
5-84	19	5-180A-TC	57	5-256	28, 359
5-86	19	5-180B-TC	57	5-260	28, 398
5-88	19	5-180TC	57	5-262	28, 423
5-90	19	5-181	24	5-264	28, 359
5-100	19	5-181A-TC	57	5-265	28
5-102	19	5-181B-TC	57	5-266	28
5-104	19	5-181-TC	57	5-267	28
5-106	19	5-182	24, 334, 359	5-268	28
5-108	19	5-182A-TC	57	5-270	29, 328

Numerical Index



CAT. NO.	PAGE	CAT. NO.	PAGE	CAT. NO.	PAGE
5-271	29, 328	5-SC-120	60	6-64	65
5-272	29, 328	5-SC-122	60	6-68	65
5-273	29, 328	5-SC-124	60	6-72	65
5-274	29, 328	5-SC-126	60	6-74	65
5-275	29, 328	5-SC-128	61	6-76	65
5-276	29, 328	5-SC-130	61	6-82	65
5-277	29, 328	5-SC-180	61	6-84	65
5-278	29, 328	5-SC-182	61	6-86	65
5-279	29, 328	5-SC-182TC	63	6-90	65, 321
5-280	29, 328	5-SC-188	61	6-92	65, 321
5-281	29, 328	5-SC-283	62	6-94	65, 321
5-282	29, 328	5-SC-284	62	6-96	65, 321
5-282A	29, 328	5-SC-304	62	6-100	67, 321
5-283	24	5-SC-304TC	63	6-104	67, 322, 428, 537
5-284	24, 334, 532	5-SC-306	62	6-106	67, 322, 428, 537
5-286	24, 334	5-SC-306TC	63	6-107	67, 322, 428, 537
5-288	24, 334, 359	5-SC-320	62	6-108	67, 322, 428, 537
5-290	30, 334, 532	5D-251	27, 423, 478, 516	6-109	67, 322, 428
5-291	30, 334	5D-253	27, 423, 478, 516	6-109A	67, 322, 428
5-300	30, 254, 329, 527	5D-255	27	6-110	69
5-302	30, 254, 329, 527	5D-303	30, 254, 329, 527	6-112	69, 322
5-304	30, 254, 329, 527	5D-322	35, 334, 532	6-114	69, 322
5-304TC	58	5D-324	35, 257, 334, 532	6-118	69, 322, 427, 537
5-306	30, 254, 329, 527	5D-326	35, 331, 351	6-118A	69, 322, 427, 537
5-306TC	58	5D-328	27	6-118TC	88
5-308	30, 254, 329, 527	5D-329	27	6-118XL	68, 69, 322, 427, 537
5-310	34, 256, 330	6-2	64	6-120	70, 323, 427, 537
5-312	34, 257, 331, 529	6-4	64	6-120A	70, 323, 427, 537
5-312TC	58	6-6	64	6-120XL	68, 70, 323, 427, 538
5-314	34, 257, 331, 529	6-8	64	6-121	70, 323, 427, 538
5-314TC	58	6-8XL	64, 68	6-122	70, 323, 427, 538
5-316	35, 331, 351	6-10	64	6-123	70, 323, 427, 538
5-318	35, 331, 351	6-12	64	6-123TC	88
5-320	35, 334, 532	6-14	64	6-123XL	68, 70, 323, 427, 538
5-320TC	59	6-16	64	6-124	70, 324, 428, 538
5-510	51	6-18	64	6-124TC	88
5-512	51	6-24	64, 320	6-124XL	68, 70, 324, 428, 538
5-514	51	6-26	64, 320	6-125	70, 324, 374, 538
5-516	51	6-28	64, 320	6-126	71, 324, 428, 538
5-547	51, 467	6-28XL	64, 68, 320	6-128	71, 504
5-550	51	6-30	64, 320	6-132	71
5-560	51	6-30TC	88	6-134	71, 324, 504
5-561	51	6-40	65	6-136	71, 504
5-564	51	6-42	65	6-138	71, 324, 429
5-568	52, 467	6-44	65	6-140	71, 324, 399, 429
5-600	52, 467	6-44XL	65, 68	6-141	71, 399, 504
5-700	52	6-46	65	6-142	71, 399, 504
5-702	52	6-47	65	6-144	71, 399, 504
5-800	52, 466	6-48	65	6-145	71, 399, 504
5-998	52, 466	6-50	65	6-146	71
5-1000	52, 466	6-52	65	6-150	71
5-SC-16	60	6-60	65	6-154	71, 406
5-SC-46	60	6-62	65	6-154TC	89



Numerical Index

CAT. NO.	PAGE	CAT. NO.	PAGE	CAT. NO.	PAGE
6-156	71, 406	7-14	91	7-162	95
6-156TC	89	7-16	91	7-164	95
6-158	71, 406	7-20	91	7-166	95
6-158TC	89	7-24	91, 267, 326	7-167	95
6-159	71, 406	7-24A	91	7-170	95
6-160	72, 406	7-26	91, 267, 326	7-172	95
6-162	72, 406	7-30	91, 196, 326	7-180	95
6-164	72, 406	7-32	91, 196, 326	7-182	95
6-164A	72, 406	7-36	92	7-190	95, 356, 515
6-165TC	89	7-38	92	7-200	98, 201
6-166	72, 428	7-42	92	7-202	98, 201
6-166TC	89	7-44	92	7-206	98, 202, 403
6-168	72, 428	7-46	92	7-210	100, 327
6-180	72, 429	7-48	92	7-210A	100
6-182	72, 429	7-50	92, 327	7-220	476, 102
6-184	72, 429	7-52	92, 327	7-230	103, 197, 209
6-186	72, 429	7-60	92, 197	7-232	103, 197, 209
6-188	72, 428	7-62	92, 197	7-234	103, 197, 209
6-189	72, 428	7-66	92	7-236	103, 197, 209
6-190	73, 292, 429	7-68	92	7-240	103, 430
6-192	73, 292, 429	7-70	93, 327	7-242	103, 430
6-197	73, 275, 292, 429	7-72	93, 327	7-250	103, 402
6-198	73, 275, 292, 429	7-82	93	7-252	103, 402
6-198TC	89	7-84	93	7-254	103, 402
6-200	73, 399	7-90	93	7-255	105, 203, 402
6-202	73, 399	7-91	93	7-256	105, 203, 402
6-204	73, 399, 504	7-92	93	7-257	105, 203, 402
6-210	73, 399, 504	7-94	93	7-258	105, 203, 402
6-212	73, 399	7-96	93, 197	7-259	105, 203, 402
6-214	73, 209, 399	7-102	94, 430	7-260	107, 477
6-300	83	7-106	94, 208, 476	7-262	107, 477
6-302	83	7-110	94, 327	7-264	107, 477
6-304	83	7-112	94, 327	7-266	107, 477
6-308	83	7-118	94	7-280	108, 267, 406
6-310	83	7-120	94	7-282	108, 406
6-312	83	7-122	94	7-284	108, 267, 406
6-314	83	7-124	94, 514	7-286	108, 406
6-316	83	7-126	94, 514	7-288	108, 406
6-318	83	7-128	94, 514	7-290	108, 267, 406
6-330	84	7-130	94, 514	7-292	108, 406
6-336	84	7-136	94	7-294	108, 267, 406
6-337	84	7-138	94	7-296	108, 406
6-338	84	7-140	94	7-298	108, 406
6-340	84	7-142	94, 514	7-300	108, 327
6-342	84	7-144	94, 514	7-302	108, 327
6-350	85	7-146	94, 514	7-304	108, 327
6-400	85	7-148	94, 514	7-305	108, 327
7-2	90, 326	7-150	95	7-310	108, 224, 267, 327, 406
7-4	90, 326	7-152	95	7-315	108, 224, 267, 327, 406
7-8	90, 267, 326, 430	7-154	95	7-500	109
7-10	90, 267, 326, 430	7-156	95	7-501	109
7-11	90, 326	7-157	95	7-504	109
7-12	90, 326	7-160	95	7-506	109

Numerical Index



CAT. NO.	PAGE	CAT. NO.	PAGE	CAT. NO.	PAGE
7-510	109	8-44TC	125	8-136	118
7-514	109	8-46	115, 342	8-706TC	130
7-515	109	8-46TC	125	8-744TC	130
7-600	110, 499	8-48	115	8-746TC	130
7-602	110, 499	8-48TC	125	8-748TC	130
7-604	110, 356	8-49TC	125	8-750TC	130
7-606	110, 356	8-50	115, 343	8-751TC	130
7-610	110, 499	8-50A-TC	125	8-752TC	130
7-612	110, 499	8-50TC	125	8-753TC	130
7-614	110, 356	8-51	115, 343	8D-36	112, 340, 534
7-616	110, 356	8-51TC	126, 407	9-1	135
7-620	111, 498	8-52	115	9-2	135
7-622	111, 498	8-52TC	126, 407	9-4	135
7-624	111, 498	8-53	115	9-6	135
7-630	111, 499	8-53TC	126, 407	9-8	135
7-632	111, 499	8-55TC	126, 407	9-10	135
8-2	112, 340	8-57TC	126, 407	9-32	135, 424
8-4	112, 340, 534	8-58	115, 343	9-40-18	135
8-4TC	123	8-59	115, 343	9-40-20	135
8-6	112, 340, 534	8-62TC	126, 407	9-40-22	135
8-6TC	123	8-63TC	126, 407	9-40-24	135
8-7	112, 340, 534	8-65TC	126, 407	9-40-25	135
8-7A-TC	123	8-66TC	126, 407	9-40-26	135
8-7TC	123	8-67TC	126, 407	9-40-28	135
8-8	112, 340, 534	8-69TC	126, 407	9-40-30	135
8-8A-TC	123	8-70	116	9-40-32	135
8-8TC	123	8-74	116	9-40-34	135
8-10	113, 341	8-76	116	9-40-36	135
8-12	113, 341	8-80	116	9-44-18	135
8-14	113, 341, 535	8-81TC	126	9-44-20	135
8-14A	113, 341, 535	8-82TC	127	9-44-22	135
8-14A-TC	124	8-83TC	127	9-44-24	135
8-14TC	124	8-84	116	9-44-25	135
8-15	113, 341	8-94	116, 343	9-44-26	135
8-15TC	124	8-96	117, 343	9-44-28	135
8-16	113, 341	8-96TC	127, 408	9-44-30	135
8-16TC	124	8-100	117	9-44-32	135
8-17	113	8-100TC	127	9-44-34	135
8-17TC	124	8-101TC	128, 408	9-50	136
8-20	113, 341	8-102	117, 467	9-52	136
8-22	114, 342	8-102TC	127	9-54	136
8-23	114, 342	8-103TC	128, 408	9-60	136
8-26	114, 265, 342, 535	8-104TC	128, 408	9-62	136
8-28	114, 342, 535	8-105TC	128, 408	9-74	137, 424
8-28TC	124	8-106TC	128, 408	9-80	137, 424
8-30	114, 342	8-107TC	128, 408	9-90	137, 424
8-30TC	124	8-114	117	9-94	137
8-32	114	8-114TC	127, 408	9-96	39, 138, 339
8-40	114, 342, 535	8-122	118	9-96	39, 138
8-40TC	124	8-130	115	9-100	39, 138, 263, 332, 533
8-42	115, 342	8-130TC	125	9-101	39, 138, 263, 332, 533
8-42TC	125	8-134	118	9-102	39, 138, 332, 533
8-44	115, 342	8-134TC	128, 408	9-103	39, 139, 333, 533



Numerical Index

CAT. NO.	PAGE
9-104	39, 139, 333, 533
9-106	40, 139, 351
9-108	40, 139, 333, 533
9-110	40, 139, 263, 333, 533
9-120	40, 141, 339
9-122	40, 141, 339
9-124	40, 141, 339
9-124TC	59, 141, 339
9-128	142, 443
9-140	142
9-142	142
9-146	142
9-148	142
9-154	143, 358
9-156	143, 358
9D-121	40, 141, 339
9D-123	40, 141, 339
9D-132	41, 141, 339
9D-133	41, 141, 339
9D-134	41, 141, 339
9D-135	41, 141, 339
10-2-NS	144
10-2-ST	144
10-4-NS	144
10-4-ST	144
10-6-NS	144
10-6-ST	144
10-8-NS	144
10-8-ST	144
10-10-NS	144
10-10-ST	144
10-12-NS	144
10-12-ST	144
10-14-NS	144
10-14-ST	144
10-22-SS	144
10-22-ST	144
10-24-SS	144
10-24-ST	144
10-26-SS	144
10-26-ST	144
10-28-SS	144
10-28-ST	144
10-30-SS	144
10-30-ST	144
10-32-SS	144
10-32-ST	144
10-34-SS	144
10-34-ST	144
10-38	144
10-89	144
10-70	144
10-72	144

CAT. NO.	PAGE
10-74	144
10-76	144
10-79	144
10-80	144
10-82	144
10-84	144
10-220	147, 299
10-290	150
10-291	150
10-310	148
10-312	148
11-2	151, 280, 411
11-4	151, 280, 411
11-6	151, 280
11-8	151, 280, 411
11-10	151, 281, 412
11-12	152, 281, 545
11-13	152, 281, 545
11-14	152, 281, 545
11-16	152, 281, 545
11-17	152
11-18	152
11-19	152
11-20	154, 195
11-22	154, 195
11-23	154
11-30	154, 229, 310, 368, 544
11-32	154, 229, 310, 368, 544
11-34	154, 229, 310, 368, 544
11-36	154, 310, 368, 544
11-38	154, 310, 368, 544
11-40	154, 310, 368, 544
11-42	158
11-43	158
11-44	158
11-45	158
11-46	158
11-47	158
11-48	158
11-49	158
11-50	155, 310, 368, 544
11-52	155, 310, 368, 544
11-54	155, 310, 368, 544
11-56	155, 310, 368, 544
11-58	155, 310, 368, 544
11-60	155, 310, 368, 544
11-73	158, 312, 368
11-74	158, 195, 312, 368, 545
11-76	158, 195, 312, 368, 545
11-78	158, 195
11-79	158
11-80	158, 195, 312, 368, 545
11-81	158, 195, 312, 368, 545

CAT. NO.	PAGE
11-82	160, 188, 312, 368
11-88	160, 312
11-90	160, 312
11-92	160, 312
11-94	160, 312
11-96	160, 312
11-100	161, 432
11-102	161, 432
11-110	161
11-112	161
11-114	161
11-116	161
11-118	163
11-120	163
11-122	163
11-130	163
11-132	163
11-134	163
11-136	163
11-140	163
11-144	163
11-146	163
11-150	164
11-152	164
11-153	164
11-154	164
11-155	164
11-160	164
11-162	164
11-164	164
11-166	164
11-180	164, 494
11-182	164, 494
11-184	164, 494
11-185	165, 494
11-192	166, 204
11-194	166, 204
11-196	166, 204
11-200	166
11-202	166
11-204	166
11-206	167
11-208	167
11-210	167
11-218	167
11-219	167
11-220	167
11-221	167
11-222	167
11-223	167
11-224	168
11-224A	168
11-225	168

Numerical Index



CAT. NO.	PAGE	CAT. NO.	PAGE	CAT. NO.	PAGE
11-240	168, 438	11-442	179	11-634-BL	184, 282, 412
11-242	168, 438	11-444	179	11-634-SH	184, 282, 412
11-244	168, 438	11-446	179	11-642-BL	184, 195, 412, 438
11-246	168, 393	11-448	179	11-642-SH	184, 195, 412, 438
11-247	168, 393	11-470	180	11-650	185, 438
11-248	168, 393	11-500	181, 188, 447	11-652	185, 438
11-249	168, 393	11-502	181, 188, 447	11-654	185, 438
11-250	168, 393	11-504	181, 447	11-656	185, 438
11-252	168, 393	11-506	181, 447	11-660	186, 437
11-254	168, 393	11-508	181, 447	11-672	186, 391, 437
11-256	168, 393	11-512	181, 447	11-676	186, 391, 437
11-260	169	11-514	181, 447	11-684	187, 196, 438
11-260-A	169	11-516	181, 447	11-686	187, 438
11-260-B	169	11-530	181, 448	11-700	187, 412
11-266	169	11-532	181, 448	11-702	187, 412
11-267	169	11-534	181, 448	11D-27	154, 228, 310, 368, 544
11-268	169	11-538	181, 448	12-80	196, 503
11-269	169	11-538	181, 448	12-90	143, 196
11-270	169	11-540	181, 448	12-92	143, 196
11-272	169	11-542	181, 448	12-170	197
11-274	169	11-544	181, 448	13-8	198
11-276	169	11-546	182	13-9	198
11-290	170	11-547	182	13-10	198
11-292	170	11-548	182	13-11	198
11-300	170	11-549	182	13-20	198
11-314	170, 392	11-551	182	13-40	198
11-316	170, 392	11-552	182	13-42	198
11-318	170, 392	11-553	182	13-44	198
11-342	170	11-554	182	13-46	198
11-346	171	11-560	182	13-48	198
11-349	172, 393, 448	11-562	182	13-50	198
11-350	172, 393, 448	11-564	182	13-60	198
11-352	172, 393, 448	11-566	182	13-62	198
11-360	172	11-568	182	13-64	198
11-362	172	11-570	182	13-66	198
11-365	173, 439, 495	11-572	182	13-68	198
11-366	173, 439, 495	11-574	182	13-70	198
11-368	173, 495	11-580	182, 446	13-72	198
11-374	173, 495	11-582	182, 446	13-74	198
11-390	174, 486	11-590	182, 393	13-120	198
11-392	174, 486	11-600	184, 282	13-122	198
11-400	175	11-602	184, 282	13-124	198
11-402	175	11-608	184, 282	13-126	198
11-404	175	11-610	184, 282	13-128	198
11-410	176	11-611	184	13-130	198
11-414	177	11-614	184, 282	13-132	198
11-420	177	11-616	184, 282	13-134	198
11-421	177	11-617	184	13-150	198
11-424	177	11-618	184	13-152	198
11-428	178	11-620	184	13-154	198
11-430	178	11-622	184	13-156	198
11-432	178	11-630-BL	184, 282, 412	14-2	146, 199
11-440	179	11-630-SH	184, 282, 412	14-4-15	146, 199



Numerical Index

CAT. NO.	PAGE
14-4-18	146, 199
14-8	199
14-10-3	199
14-10-4	199
14-10-5	199
14-10-6	199
14-10-7	199
14-10-8	199
14-10-9	199
14-10-10	199
14-10-11	199
14-12	146, 199
14-22	200
14-24-17	200
14-24-21	200
14-24-24	200
14-24-27	200
14-26-L	200
14-26-M	200
14-26-S	200
14-27	200
14-28	200
14-29	200
14-46	100, 201
14-48	100, 201
14-49	100, 201
14-50	100, 201
14-51	101, 201
14-52	101, 202
14-56	101, 202
14-62	101, 203
14-66	103, 203, 401
14-69	204
14-84	205
14-86	205
14-88	205
14-90	205
16-2	206
16-3	206
16-4	206
16-6	206
16-8	206
16-10	206, 477
16-12	206, 400
16-20	206
16-22	206
16-24	206, 477
16-25	206
16-26	206
16-30	206, 476
16-31	207
16-33	207
16-34	207

CAT. NO.	PAGE
16-38	207, 476, 502
16-40	207, 400
16-42	207
16-44	207
16-46	207, 400
16-48	207, 400
16-51	208, 501
16-52	208, 401
16-54	208, 401
16-56	208, 400
16-62	208
16-70	209
16-72	209, 401
16-80	73, 209, 399
16-99	104, 210
16-100	104, 210
16-102	104, 210
16-108	104, 210
16-110	104, 210
16-120	104, 211
16-122	104, 211
16-130	105, 211
16-132	105, 211
16-140	105, 211
16-160	105, 211
16-162	105, 211
16-170	212
16-172	212
16-174	212
16-176	212
16-190-3	213
16-190-4	213
16-192	213
16-194	213
16-196	213
16-198	213
16-208	213
16-229	214
16-230	214
16-232	214
16-234	214
16-250	214
16-252	214
16-254	214
16-256	214
17-100	215
17-115	42, 215
17-120	42
17-215	42, 215
17-301	86, 218
17-302	86, 218
17-303	86, 138, 218
17-303C	86, 218

CAT. NO.	PAGE
17-303X	86, 218
17-304	86, 218
17-305	86, 218
17-305X	87, 219
17-306	87, 219
17-307	87, 219
17-307X	87, 219
17-500	42, 215
17-980	119, 222, 344
17-1000	119, 222, 344
17-1010	119, 222, 344
17-1020	119, 222, 344
17-1024	119, 222, 344
17-1025	119, 222, 344
17-1090TC	129, 222, 408
17-1091TC	129, 222, 408
17-1092TC	129, 222, 408
17-1100	74, 219
17-1150	74, 219
17-2040	43, 216
17-2060	43, 216
17-2100	43, 216
17-2110	43, 216
17-2150	43, 216
17-2160	43, 216
17-2500	70, 220, 323, 427, 538
17-2510	69, 220, 322, 427, 537
17-2600	90, 223, 267, 326, 430
17-2602	90, 223, 267, 326, 430
17-2603	103, 223, 402, 430
17-4000	223
17-4005	223
17-4010	223
17-4015	223
17-4030	223
17-4050	223
17-4060	223
17-4070	223
17-4100	223
17-4102	223
17-4800	224, 287, 353
17-4801	224, 287, 353
17D-4802	224, 353
18-2	225
18-4	225
18-10	225
18-12	225
18-14	225
18-20	225
18-22	225
18-24	225
18-30	226
18-32	226



CAT. NO.	PAGE	CAT. NO.	PAGE	CAT. NO.	PAGE
18-33	226	18-350	232	18-542	236
18-34	226	18-370	232	18-550	236
18-35	227	18-372	233	18-562	237
18-36	227	18-374	233	18-564	237
18-46	227	18-376	233	18-566	237
18-47	227	18-380	233	18-568	237
18-50	227	18-384	233	18-570	237, 546
18-54	227	18-388	233	18-573A	237
18-62	227	18-390	233	18-574	237
18-63	227	18-398	233	18-576	237
18-64	227	18-398M	233	18-584	237
18-66	228	18-399	233	18-613	238
18-68	228	18-400	234	18-620	74, 238
18-80	153, 228	18-402	234	18-624	74, 238
18-84	153, 228	18-402A	234	18-628	238
18-88	153, 228	18-402B	234	18-632	74, 238
18-96	153, 228	18-404	234	18-650	238, 317
18-100	155, 229, 310, 544	18-412	188, 234, 309, 542	18-657	239, 317
18-102	155, 229, 310, 544	18-414	188, 234, 309, 542	18-658	239, 317
18-110	154, 229, 312, 546	18-416	188, 234, 309, 542	18-660	239, 317, 546
18-112	154, 229, 546	18-418	189, 234, 309	18-666	239
18-114	154, 229, 546	18-420	189, 234, 309	18-680	240
18-116	154, 229, 546	18-424	189, 234	18-688	240
18-120	229	18-428	189, 234, 309	18-691	240
18-132	230	18-439	155, 235, 310, 544	18-692	240
18-132A	230	18-440	189, 235	18-694	240
18-134	230	18-442	189, 235	18-696	240
18-134A	230	18-446	189, 235	18-698	240
18-139	230	18-450	189, 235	18-700	240
18-140	231	18-452	189, 235	18-710	145, 240
18-142	231	18-454	189, 235	18-712	145, 240
18-144	231	18-472	235	18-714	145, 240
18-146	231	18-480	235	18-716	145, 240
18-148	231	18-482	235	18-718	145, 240
18-152	231	18-484	235	18-720	145, 240
18-154	231	18-486	235	18-722	145, 240
18-170	231	18-498	236	18-724	145, 240
18-171	231	18-499	236	18-726	145, 240
18-172	231	18-500	236	18-728	145, 240
18-259	232	18-502	236	18-730	145, 240
18-260	232	18-504	236	18-732	145, 240
18-262	232	18-506	236	18-740	145, 240
18-264	232	18-510	236	18-742	145, 240
18-270	232	18-512	236	18-744	145, 240
18-292	232	18-514	236	18-746	145, 240
18-302	232	18-520	236, 525	18-748	145, 240
18-304	232	18-522	236, 525	18-750	145, 240
18-306	232	18-524	236, 525	18-779	64, 241, 320, 539
18-314	232	18-530	236, 525	18-780	64, 241, 320, 539
18-320	232	18-532	236, 525	18-781	64, 241, 320, 539
18-330	232	18-534	236, 525	18-782	64, 241, 320, 539
18-331	232	18-536	236, 525	18-783	64, 241, 320, 539
18-344	232	18-540	236	18-784	64, 241, 320, 539



Numerical Index

CAT. NO.	PAGE	CAT. NO.	PAGE	CAT. NO.	PAGE
18-785	66, 242, 321, 540	18-949	78, 220, 247	18-1252	325
18-786	66, 242, 321, 540	18-950	247, 541	18-1260	253
18-787	66, 242, 321, 540	18-951	247, 541	18-1262	253
18-788	66, 242, 321, 540	18-952	247, 541	18-1392	31, 254, 330, 528
18-789	66, 242, 321, 540	18-953	221, 247, 541	18-1394	31, 254, 330, 528
18-790	66, 242, 321, 540	18-954	247, 541	18-1396	31, 254, 329, 528
18-791	66, 242, 321, 540	18-955	247, 541	18-1398	31, 254, 329, 528
18-793	74, 242	18-956	78, 247	18-1404	31, 255, 330, 528
18-794	74, 242	18-958	78, 247	18-1405	31, 255, 330, 528
18-795	74, 243	18-962	78, 247	18-1415	31, 255, 329, 528
18-795A	74, 243	18-964	78, 247	18-1416	31, 255, 329, 528
18-796	74, 243	18-966	78, 248	18-1417	31, 255, 329, 528
18-798	74, 243	18-970	79, 248	18-1418	31, 255, 329, 528
18-804	75, 243	18-971	79, 248	18-1419	31, 255, 332, 529
18-814	75, 243	18-974	248	18-1420	32, 256, 330, 529
18-816	75, 243	18-975	248	18-1422	32, 256, 330, 529
18-818	75, 243	18-978	79, 248	18-1426	32, 256, 330, 529
18-820	75, 243	18-980	87, 249	18-1428	32, 256, 330, 529
18-825	75, 243	18-1000	249	18-1430	34, 256
18-827	75, 243	18-1002	249	18-1432	34, 256
18-828	75, 243	18-1004	249	18-1440	32, 257, 332, 529
18-829	75, 244	18-1050	249	18-1453	34, 257, 331, 529
18-830	75, 244	18-1058	249	18-1454	34, 257, 331, 529
18-834	75, 243	18-1060	250	18-1460	45, 257, 331, 530
18-835	75, 220, 244	18-1080	250	18-1462	45, 257, 331, 530
18-836	76, 220, 244	18-1081	250	18-1464	45, 257, 331, 530
18-837	76, 220, 244	18-1100	79, 250	18-1466	45, 257, 331, 530
18-838	76, 220, 244	18-1102	79, 250	18-1470	45, 257, 331, 530
18-840	76, 244	18-1104	79, 250	18-1472	45, 257, 331, 530
18-850	76, 244, 324, 540	18-1106	80, 250	18-1474	45, 257, 330
18-852	76, 244	18-1107	80, 138, 251, 325, 541	18-1476	45, 257, 331, 530
18-854	76, 324, 244, 540	18-1108	80, 251	18-1477	45, 258, 332, 530
18-860	245	18-1110	80, 251	18-1478	45, 258, 332, 530
18-866	76, 244, 322, 541	18-1111	80, 251	18-1480	46, 258, 530
18-867	76, 221, 244, 322	18-1112	80, 251	18-1482	46, 258
18-868	76, 244, 322, 541	18-1114	80, 251	18-1484	46, 258
18-870	245	18-1116	80, 251	18-1486	41, 140, 258, 333, 530
18-876	245, 541	18-1136	252, 325	18-1487	46, 258
18-878	245, 541	18-1138	252, 325	18-1488	46, 258
18-880	77, 245	18-1150	252, 325	18-1494	46, 259
18-881	77, 245	18-1160	252, 325	18-1496	46, 259
18-883	77, 245	18-1162	252, 325	18-1498	46, 259
18-896	77, 245	18-1170	252	18-1510	32, 259, 530
18-897	77, 245	18-1174	252	18-1512	32, 259, 530
18-904	246	18-1178	252	18-1514	32, 259, 530
18-906	246	18-1182	252	18-1516	32, 259, 530
18-908	246	18-1188	253	18-1520	32, 259
18-912	77, 246	18-1190	253	18-1521	32, 259
18-914	77, 246	18-1200	253	18-1524	33, 259
18-916	78, 246	18-1202	253, 325	18-1526	33
18-946	78, 247	18-1204	253	18-1540	47, 260
18-947	78, 247	18-1208	253	18-1550	33, 260
18-948	78, 220, 247	18-1220	253	18-1552	33, 260

Numerical Index



CAT. NO.	PAGE	CAT. NO.	PAGE	CAT. NO.	PAGE
18-1554	33, 260	18-1950-8	268	19-70	270
18-1558	43, 216, 260	18-1952-7	268	19-71	270
18-1559	43, 216, 260	18-1952-8	268	19-71-1	270
18-1560	47, 260	18-1952-9	268	19-71-2	270
18-1562	47, 260	18-1952-10	268	19-71-3	270
18-1570	47, 261	18-1980	268, 296, 313	19-74	271
18-1572	47, 261	18-1962	268	19-75	271
18-1576	47, 261	18-1964	268	19-78	271
18-1578	47, 261	18-1968	268, 295, 308, 351, 434	19-100	2, 272
18-1594	47, 261	18-1990	268, 285, 303	19-102	2, 272
18-1596	47, 261	18-1992	268, 285, 303	19-104	2, 272
18-1600	48, 261	18-1994	268, 285, 303	19-106	2, 272
18-1602	48, 261	18-1996	268, 285, 303	19-108	2, 272
18-1604	48, 261	18-2200	268	19-110	2, 272
18-1618	33, 44, 217, 262	18-SC-1472	63	19-112	2, 272
18-1619	33, 44, 217, 262	18-SC-1476	63	19-120	2, 272
18-1620	48, 262	19-2	269	19-120A	2, 272
18-1622	48, 262	19-2-1	269	19-170	273, 291
18-1623	48, 262	19-2-2	269	19-172	273, 291
18-1624	48, 262	19-2-3	269	19-180	273, 291
18-1625	33, 44, 217, 262	19-2-4	269	19-182	273, 291
18-1626	33, 44, 217, 262	19-10	269	19-190	273, 291
18-1630	44, 217, 262	19-10A	269	19-192	273, 291
18-1631	44, 217, 262	19-12	269	19-200	273, 291
18-1633	44, 217, 262	19-14	269	19-202	273, 291
18-1634	44, 217, 262	19-16	269	19-210	145, 273
18-1652	41, 140, 263, 333, 531	19-18	269	19-220	190, 273
18-1653	41, 140, 263, 333, 531	19-20	269	19-222	190, 273
18-1716	262	19-21	269	19-226	190, 273
18-1718	262	19-22	269	19-228	190, 273
18-1800	120, 264, 345, 535	19-23	269	19-240	274
18-1800TC	128, 266	19-24	269	19-242	274
18-1810	120, 264, 345, 535	19-25	269	19-244	274
18-1816TC	128, 266	19-30	269	19-246	274
18-1820	120, 264, 345, 536	19-32	269	19-248	274
18-1824	120, 264, 345, 536	19-34	269	19-260	274, 525
18-1828	120, 264, 345, 536	19-36	269	19-262	274, 525
18-1828A-TC	129, 266	19-40	270	19-264	274, 525
18-1828TC	129, 266	19-48	270	19-266	274, 525
18-1831	120, 264, 346, 536	19-48-A	270	19-268	274, 525
18-1832	120, 264, 345, 536	19-48-B	270	19-270	274, 525
18-1832A-TC	129, 266	19-48-C	270	19-272	274, 525
18-1832TC	129, 266	19-48-D	270	19-274	274, 525
18-1833	120, 264, 346, 536	19-48-E	270	19-276	274, 525
18-1834	121, 264, 346, 536	19-50-1	270	19-278	274, 525
18-1837	121, 265, 346	19-50-2	270	19-280	274
18-1838	121, 265, 346, 536	19-50-3	270	19-282	274
18-1839	121, 265, 346, 536	19-50-4	270	19-284	274
18-1840	121, 265, 346, 536	19-50-5	270	19-286	274
18-1858	121, 265	19-50-6	270	19-288	274
18-1934	90, 267	19-50-7	270	19-290	274
18-1936	90, 267	19-50-8	270	19-292	274
18-1950-7	268	19-50-9	270	19-294	274



Numerical Index

CAT. NO.	PAGE	CAT. NO.	PAGE	CAT. NO.	PAGE
19-296	274	19-580	149, 279, 426	19-1234	287
19-298	274	19-582	149, 279, 426	19-1330	287
19-300	274	19-584	149, 279, 426	19-1334	287
19-302	274	19-589	149, 279	19-1338	287
19-314	274	19-590	279	19-1340	287
19-316	274	19-655	185, 283	19-1350	287
19-318	274	19-660	185, 283	19-1352	287
19-350	81, 275	19-668	185, 283	19-1354	287
19-356	81, 275	19-669	185, 283	19-1356	287
19-360	81, 275	19-700	284, 436, 456	19-1820	149, 287
19-370	81, 275	19-702	284, 436, 456	19-2060	48, 288
19-371	81, 275, 292	19-704	284, 436, 456	19-2081-B	221, 288
19-380	275	19-706	284, 436, 456	19-2090-B	221, 288
19-381	275	19-708	284, 436, 456	19-2100	221, 288
19-382	275	19-710	284, 436, 456	19-2100-B	221, 288
19-383	275	19-712	284, 436, 456	19-2110	221, 288
19-384	275	19-714	284, 436, 456	19-2110-B	221, 288
19-385	275	19-716	284, 436, 456	19-2120	288
19-390	275	19-718	284, 436, 456	19-2130	288
19-394	275	19-720	284, 436, 456	19-2138	221, 288
19-396	275	19-750	284, 449	19-2150-B	48, 217, 288
19-400	276	19-752	284, 449	20-2	289
19-404	276	19-754	284, 449	20-3	289
19-410	276	19-756	284, 449	20-4	289
19-414	276	19-758	284, 449	20-6	289
19-429	277	19-760	284, 449	20-7	289
19-430	277	19-770	284, 449	20-12	289
19-434	277	19-772	284, 449	20-20	289
19-437	277	19-774	284, 449	20-24	289
19-438	277	19-776	284, 449	20-28	290
19-439	277	19-778	449	20-29	290
19-442	277	19-780	284, 449	20-30	290
19-464	277	19-784	284	20-32	290
19-465	277	19-785	284	20-38-35	290
19-468	277	19-790	284, 316, 453	20-38-50	290
19-500	278	19-792	284, 316, 453	20-36-75	290
19-502	278	19-793	285, 316, 453	20-36-90	290
19-504	278	19-794	285, 316, 453	20-37-45	290
19-510	278	19-795	285, 316, 453	20-37-75	290
19-512	278	19-796	285, 316, 453	20-100	145, 291
19-520	278	19-797	285, 316, 453	20-102	145, 291
19-524	278	19-804	285, 353, 459	20-120	81, 291
19-562	148, 279, 426	19-808	285, 353, 414, 459	20-124	292
19-563	148, 279, 426	19-840	286, 415, 460	20-126	292
19-564	148, 279, 426	19-844	286, 353, 415, 461	20-130	292
19-565	148, 279, 426	19-848	415, 460	20-140	293
19-570	148, 279, 426	19-849	286, 415, 460	20-142	293
19-572	148, 279, 426	19-850	286, 397, 415, 460	20-144	293
19-573	148, 279, 426	19-852	286, 397, 415, 460	20-148	293
19-574	148, 279, 299, 426	19-854	286, 397, 415, 460	20-150	293
19-575	148, 279, 426	19-856	286, 397, 415, 460	20-160	49, 294
19-576	148, 279, 426	19-1230	286	20-164	49, 294
19-577	148, 279, 426	19-1232	286	20-168	49, 294

Numerical Index



CAT. NO.	PAGE	CAT. NO.	PAGE	CAT. NO.	PAGE
20-177	294	20-500	300	20-926	306
20-178	294	20-504	300	20-928	306
20-180	294	20-506	300	21-2	307
20-182	294	20-510	300	21-4	307
20-184	294	20-522	300	21-8	307
20-186-4	294	20-530	301	21-16	307
20-186-5	294	20-532	301	21-18	307
20-200	295	20-544	301	21-20	307
20-202	295	20-546	301	21-24	307
20-216	295, 315	20-552	301	21-28	307
20-218	295, 315	20-553	301	21-32	307
20-220	295, 315	20-554	302	21-40	307
20-222	295, 315	20-556	302	21-60	308
20-224	295, 315	20-570	302	21-62	308
20-230	295	20-572	302	21-63	308
20-238	295	20-580	302	21-64	308
20-242	296	20-582	302	21-68	308
20-246	296	20-584	302	21-72	308
20-258	296	20-594	302	21-85	190, 309, 542
20-270	296, 313	20-596	302	21-86	190, 309, 542
20-274	296, 313	20-598	302	21-87	190, 309, 542
20-278	296, 315	20-630	302	21-88	190, 309, 542
20-280	296, 315	20-660	303, 418	21-89	190, 309, 542
20-282	296, 315	20-662	303, 418	21-90	190, 309, 543
20-284	296, 315	20-800	304	21-92	190, 309, 543
20-300	297	20-802	304	21-94	190, 309, 543
20-308	297	20-804	304	21-102	191, 309, 543
20-312	297	20-806	304	21-103	191, 309, 543
20-330	297	20-808	304	21-107	156, 191, 310
20-332	297	20-809	304	21-108	156, 191, 310
20-334	297	20-835	155, 304	21-144	191, 311, 543
20-336	297	20-836	155, 304	21-148	156, 311
20-338	297	20-839	155, 304	21-150	156, 311
20-340	297	20-840	155	21-152	191, 234, 311, 543
20-342	297	20-850	305	21-153	191, 311, 543
20-360	297	20-852	305	21-154	191, 311, 543
20-378	297	20-854	305	21-156	191, 311, 543
20-380	297	20-856	305	21-158	191, 311, 543
20-382	297	20-858-0	305	21-160	191, 311, 543
20-400	298	20-858-1	305	21-163	156, 311
20-404	298	20-858-2	305	21-165	156, 312
20-420	298	20-858-3	305	21-176	157, 313
20-424	298	20-872	305	21-180	159, 313, 433
20-428	298	20-874	305	21-182	157, 313
20-430	298	20-876	305	21-183	157, 313
20-436	298	20-878-1	305	21-184	157, 313
20-438	298	20-878-2	305	21-185	157, 313
20-440	299	20-878-3	305	21-188	157, 313
20-442	299	20-890	305	21-190	157, 313
20-450	299	20-910	306	21-205-2	314
20-456	299	20-912	306	21-205-4	314
20-460	148, 299	20-922	306	21-205-6	314
20-466	148, 299	20-924	306	21-205-8	314



Numerical Index

CAT. NO.	PAGE	CAT. NO.	PAGE	CAT. NO.	PAGE
21-205-10	314	21-607	37, 337	22-810	358
21-205-12	314	21-608	37, 337	22-854	162, 358
21-205-15	314	21-610	37, 337	22-856	163, 358
21-206-4	314	21-612	37, 337	22-890	163, 358
21-206-7	314	21-621	38, 337	22-900	358
21-206-9	314	21-622	38, 337	22-962	28, 359
21-206-12	314	21-624	336	22-1000	360
21-212	314	21-626	338, 463	22-1002	360
21-215	314	21-627	338, 463	22-1010	360
21-216	314	21-628	338, 395, 463	22-1016	360
21-217	314	21-630	38, 337, 531	22-1020	360
21-218	314	21-632	38, 337, 531	22-1030	360
21-227	315	21-657	338	22-1041	361
21-228	315	21-658	338	22-1042	361
21-229	315	21-659	338	22-1052	361
21-232	315	21-660	338	22-1060-6	361
21-233	315	21-900	143, 338	22-1060-7	361
21-234	315	21-901	143, 338	22-1060-8	361
21-278	317	21-902	143, 338	22-1060-9	361
21-280	316	21D-559	36, 336	22-1070	361
21-282	316	22-2	347	22-1072	361
21-284	316	22-4	347	22-1074	361
21-288	317	22-6	347	22D-202	162, 347
21-290	317	22-10	347	22D-209	162, 347
21-300	317	22-16	347	22D-420	352, 459
21-321	318, 457	22-200	162, 347	22D-422	352
21-322	318, 457	22-210	162, 348	22D-424	352
21-330	318	22-300	351	22D-426	354
21-338	318	22-302	351	22D-428	354
21-342	318	22-304	351	22D-432	354
21-343	319	22-480	352, 459	23-1-000	362
21-346	319	22-481	352, 459	23-2-00	362
21-348	319	22-482	352, 459	23-4-0	362
21-352	319	22-484	352, 460	23-6-1	362
21-354	319	22-486	354	23-8-2	362
21-360	319	22-488	354	23-10-3	362
21-368	319	22-490	354	23-12-4	362
21-369	319	22-492	354	23-14-5	362
21-370	319	22-494	353	23-16-6	362
21-379	319	22-500TC	127, 142, 354, 443	23-18-7	362
21-430	192, 311, 431, 542	22-502TC	127, 142, 354, 443	23-29-000	362
21-440	325	22-550	355	23-30-00	362
21-536	41, 140, 333	22-552	355	23-32-0	362
21-537TC	59, 335, 531	22-556	355	23-34-1	362
21-539	35, 335, 530	22-558	355	23-36-2	362
21-558	36, 335	22-560	355	23-38-3	362
21-560	36, 335, 423	22-586	355	23-40-4	362
21-600	36, 336	22-660	102, 356	23-42-5	362
21-602	36, 336	22-662	102, 356	23-44-6	362
21-604	36, 336	22-666	102, 357	23-46-7	362
21-604TC	59, 336	22-668	102, 357	23-60	362
21-605	36, 336	22-802	358	23-62	362
21-606	37, 336	22-808	358	23-150	363

Numerical Index



CAT. NO.	PAGE	CAT. NO.	PAGE	CAT. NO.	PAGE
23-160	363	23-1210SS	371	24-804	376
23-162	363	23-1212SS	371	24-806	376
23-200	363	23-1214SS	371	24-808	376
23-230	363	23-1216SS	371	24-900	377
23-232	363	23-1218SS	371	24-1000	377
23-282	364	23-1219SS	371	24-1002	377
23-286	364	23-1243SS	371	24-1100	377
23-320	364	23-1244SS	371	24-1102	377
23-322	364	23-1245SS	371	24-1150	378
23-324	364	23-1246SS	371	24-1152	378
23-326	364	23-1247SS	371	24-1180	378
23-399	364	23-1248SS	371	24-1190	378
23-400	364	23-1249SS	371	24-1200	378
23-402	364	23-1250SS	371	24-1250	379
23-410	364	23-1251SS	371	24-1300	379
23-420	364	23-1350SS	372	24-1400	380
23-600	365	23-1351SS	372	24-1404	380
23-622	365	23-1352SS	372	24-1408	380
23-640	365	23-1360ST	372	24-1412	380
23-642	365	23-1361ST	372	24-1500	381
23-644	365	23-1402	369	24-1600	381
23-650	365	23-1420	369	24-1602	381
23-680	365	23-1421	369	24-1604	381
23-690	365	23-1430	369	24-1606	381
23-720	365	23-1600	372	24-1650	382
23-755	366	23-1602	372	24-1654	382
23-756	366	24-550	82, 374	24-1656	382
23-804	365	24-552	82, 374	24-2000	383
23-1047	160, 312, 367	24-554	82, 374	24-2010	383
23-1048	192, 367	24-556	82, 374	24-2020	383
23-1049	160, 313, 367	24-570	82, 374	24-2030	383
23-1050	192, 367	24-570XL	68, 82, 324, 374	24-2040	383
23-1051	192, 367	24-572	82, 374	24-2050	383
23-1060	369	24-574	82, 374	24-2100	384
23-1139SS	371	24-580	82, 374	24-2110	384
23-1140SS	371	24-582	82, 374	24-2120	384
23-1142SS	371	24-600	374	24-2500	384
23-1144SS	371	24-602	374	24-2700	385
23-1146SS	371	24-604	374	24-2710	385
23-1148SS	371	24-606	374	24-2720	385
23-1150SS	371	24-650	374	24-2960	385
23-1152SS	371	24-652	374	24-2961	385
23-1154SS	371	24-654	374	24-2962	385
23-1156SS	371	24-656	374	24-3000	386
23-1158SS	371	24-700	375	24-3010	386
23-1159SS	371	24-702	375	24-3020	386
23-1199SS	371	24-704	375	24-3200	386
23-1200SS	371	24-750	375	24-3210	386
23-1202SS	371	24-752	375	24-3220	386
23-1204SS	371	24-754	375	24-3230	387
23-1206SS	371	24-756	375	24-3240	387
23-1208SS	371	24-800	376	24-3250	387
		24-802	376	24-3260	387



Numerical Index

CAT. NO.	PAGE	CAT. NO.	PAGE	CAT. NO.	PAGE
24-3270	387	25-782	106, 402	26-62	411
25-2	388	25-784	106, 402	26-91	171, 412
25-4	388	25-786	106, 402	26-92	171, 412
25-6	388	25-800	106, 402	26-119	413, 464
25-14	388	25-812	99, 403	26-120	413, 464
25-18	388	25-814	99, 403	26-122	413, 464
25-22	388	25-821	99, 403	26-124	413, 464
25-24	388	25-834	99, 403	26-130	413, 464
25-28	389, 454	25-835	99, 403	26-132	413, 464
25-98	389	25-836	99, 403	26-134	413, 464
25-100	389	25-837	99, 403	26-138	413, 464
25-102	389	25-838	99, 403	26-140	413
25-104	389	25-840	99, 404	26-141	413
25-106	389	25-848	404	26-142	413
25-130	389	25-880	404	26-143	413
25-132	389	25-882	404	26-190	414, 459
25-134	389	25-1100	404	26-192	414, 459
25-140	390	25-1104	404	26-198	414, 459
25-142	390	25-1108	404	26-200	414
25-144	390	25-1160	404	26-220	414
25-150	390	25-1240B	26, 405	26-222	414
25-152	390	25-1240C	26, 405	26-255	416
25-154	390	25-1280	27, 406	26-256	416
25-158	390	25-1420	406	26-258	416
25-160	390	26-2	409	26-261	416
25-170	391	26-16	409	26-262	416
25-172	391	26-18	409	26-264	416, 462
25-200	392	26-20	409	26-265	416, 462
25-202	392	26-24	409	26-266	416, 462
25-204	392	26-28A	411	26-270	417
25-272	161, 393	26-28B	411	26-326	418
25-274	161, 393	26-28C	411	26-327	418
25-302	171, 394	26-28D	411	26-328	418
25-308	171, 394	26-28E	411	26-329	418
25-350	394	26-30	410	26-330	419
25-360	394, 552	26-32	410	26-331	419
25-362	394, 553	26-33-1	410	26-332	419
25-378	395	26-33-2	410	26-334	419
25-384	395, 463	26-33-3	410	26-335	419
25-395	395, 463	26-33-4	410	26-336	419
25-390	395, 463	26-35	410, 415	26-337	419
25-392	395, 463	26-40	410, 445	26-338	419
25-396	395, 463	26-42	410, 445	26-339A	419
25-440	396	26-44-1	410, 445	26-339B	419
25-454	396, 417, 461	26-44-2	410, 445	26-340	419
25-456	396, 417, 461	26-44-3	410, 445	26-370	419
25-458	396, 417, 461	26-44-4	410, 445	26-388	420
25-480	397	26-46-1	410, 445	26-389	420
25-510	397, 415, 461	26-46-2	410, 445	26-390	420
25-511	397, 415, 461	26-46-3	410, 445	26-392	420
25-754	401	26-46-4	410, 445	26-392A	420
25-760	401	26-48	410, 445	26-392B	420
25-780	106	26-60	411	26-393	420

Numerical Index



CAT. NO.	PAGE	CAT. NO.	PAGE	CAT. NO.	PAGE
26-393A	420	26-1042	224, 430	27-7	440
26-393B	420	26-1043	224, 430	27-11	441
26-394	421	26-1054	431	27-12	441
26-395	421	26-1080	431, 192	27-13	441
26-396	421	26-1084	190, 309, 431, 542	27-14	441
26-397	421	26-1086	190, 309, 431, 542	27-16	441
26-398	421	26-1090	192, 431	27-20	440
26-399	421	26-1092	192, 431	27-21	440
26-400	421	26-1150	193, 431	27-22	440
26-402	421	26-1156	193, 432	27-23	440
26-410	421	26-1170	193, 432	27-24	441
26-412	421	26-1174	193, 432	27-30	442
26-420	421	26-1326	432	27-32	442
26-422	421	26-1352	159, 433	27-34	442
26-430	421	26-1354	159, 433	27-42	442
26-435	421	26-1360	159, 433	27-44	442
26-436	421	26-1362	159, 433	27-46	442
26-437	421	26-1403	434	27-47	442
26-440	422	26-1410	434, 454	27-60	442
26-461	423	26-1412	434, 454	27-110	143, 442
26-462	423	26-1430	434	27-144	442
26-466	423	26-1432	434	27-158	443
26-470	423	26-1434	434	27-159TC	59, 443
26-471	423	26-1436	434	27-160	443
26-472	423	26-1450	435	27-161TC	444
26-474	423	26-1451	435	27-163TC	444
26-480	422	26-1452	435	27-164TC	444
26-481	422	26-1453	435	27-165TC	444
26-482	422	26-1454	435	27-175TC	444
26-483	422	26-1620	436	27-176TC	142, 444
26-484	422	26-1624	436	27-180	445
26-485	422	26-1627	436, 456	27-202	445
26-590	143, 424	26-1628	436, 456	27-204	445
26-591	143, 424	26-1629	436, 456	27-206	445
26-660	143, 425	26-1630	436, 456	27-208	445
26-700	425	26-1632	436, 456	27-210	445
26-710	425	26-1634	436, 456	27-212	445
26-724	425	26-1636	436, 456	27-213	183, 446
26-726	425	26-1638	436, 456	27-214	183, 446
26-730	425	26-1640	436, 456	27-215	183, 446
26-732	425	26-1650	436	27-216	183, 446
26-760	425	26-1652	436	27-217	183, 446
26-762	425	26-1654	436	27-218	183, 446
26-770	425	26-1656	436	27-219	183, 446
26-772	425	26-1658	436	27-223	183, 446
26-774	425	26-1660	436	27-224	183, 446
26-778	425	26-1973	173, 439	27-225	183, 447
26-780	149, 426	26-2000	173, 439	27-230	181, 188, 447
26-782	149, 426	26-2001	173, 439	27-232	181, 188, 447
26-956	82, 429	26-2005	173, 439	27-260	449
26-958	82, 429	27-2	440	27-262	449
26-1040	224, 430	27-4	440	27-264	449
26-1041	224, 430	27-6	440	27-270	449



Numerical Index

CAT. NO.	PAGE	CAT. NO.	PAGE	CAT. NO.	PAGE
27-272	449	27-496	451	27-753	455
27-274	449	27-498	451	27-754	455
27-280	449	27-499	451	27-820	455
27-282	449	27-500	451	27-821	455
27-331	450	27-502	451	27-822	455
27-332	450	27-504	451	27-824	455
27-333	450	27-506	451	27-826	455
27-334	450	27-508	451	27-920	318, 456
27-335	450	27-510	451	27-924	318, 456
27-336	450	27-512	451	27-926	456
27-418	450	27-514	451	27-928	456
27-420	450	27-516	451	27-970	457
27-422	450	27-518	451	27-972	457
27-424	450	27-520	451	27-974	457
27-426	450	27-522	451	27-980	457
27-427	450	27-530	451	27-984	457
27-428	450	27-532	451	27-990	458
27-430	450	27-534	451	27-992	458
27-432	450	27-536	451	27-1000	25, 458
27-438	450	27-538	451	27-1016	458
27-438C	450	27-540	451	27-1020	458
27-440	450	27-542	451	27-1022	458
27-440C	450	27-549	452	27-1024	458
27-442	450	27-550	452	27-1026	458
27-442C	450	27-551	452	27-1028	458
27-444	450	27-553	452	27-1295	460
27-444C	450	27-554	452	27-1297	460
27-446	450	27-556	452	27-1390	462
27-446C	450	27-558	452	27-1392	462
27-447	450	27-599	452	27-1394	462
27-447C	450	27-600	452	27-1400	462
27-448	450	27-601	452	27-1402	462
27-448C	450	27-601A	452	27-1404	462
27-449	450	27-602	452	27-1550	465
27-449C	450	27-602A	452	27-1560	465
27-450	450	27-603	452	27-1561	465
27-450C	450	27-604	452	27-1564	465
27-452	450	27-605	452	27-1565-12	465
27-452C	450	27-609	452	27-1565-18	465
27-458	451	27-610	452	27-1600	465
27-458C	451	27-660	453	27-1602	465
27-460	451	27-662	453	27-3002	466
27-460C	451	27-680	454	27-3004	466
27-462	451	27-700	454	27-3020	466
27-462C	451	27-702	454	27-3022	466
27-464C	451	27-703	454	27-3059	53, 467
27-466	451	27-744	455	27-3060	53, 467
27-466C	451	27-746	455	27-3062	53, 467
27-468	451	27-747	455	27-3070	53, 467
27-488	451	27-748	455	27-3080	468
27-490	451	27-749	455	27-3090	468
27-492	451	27-750	455	27-3094	468
27-494	451	27-752	455	27-3100	468

Numerical Index



CAT. NO.	PAGE	CAT. NO.	PAGE	CAT. NO.	PAGE
28-1	469	28-296	479	29-8-14	482
28-2	469	28-298	479	29-8-16	482
28-4	469	28-300	480	29-8-18	482
28-6	174, 469	28-302	480	29-8-20	482
28-8	174, 470	28-303	480	29-8-22	482
28-10	471	28-304	480	29-8-24	482
28-11	471	28-306	480	29-8-26	482
28-12	471	28-308	480	29-8-28	482
28-14	471	28-309	480	29-8-30	482
28-20	471	28-310	480	29-8-32	482
28-22	471	28-320	480	29-8-34	482
28-24	471	28-322	480	29-10-8	483
28-30	472	28-323	480	29-10-10	483
28-32	472	28-324	480	29-10-12	483
28-34	472	28-326	480	29-10-14	483
28-36	472	28-328	480	29-10-16	483
28-38	472	28-329	480	29-10-18	483
28-40	472	28-330	480	29-10-20	483
28-44	472	28-340	480	29-10-22	483
28-48	473	28-341	480	29-10-24	483
28-50	473	28-360	481	29-10-26	483
28-52	473	28-370	149, 481	29-10-28	483
28-64	175, 470	28-380	481	29-10-30	483
28-65	175, 470	28-382	481	29-14-8	483
28-68	175, 473	28-384	481	29-14-10	483
28-69	175, 473	28-386	481	29-14-12	483
28-70	172, 470	28-400	481, 512	29-14-14	483
28-72	172, 470	28-410	481	29-14-16	483
28-74	172, 470	28-412	481	29-14-18	483
28-79	473	28-414	481	29-14-20	483
28-80	473	28-416	481	29-14-22	483
28-100	144, 474	29-2	482	29-14-24	483
28-104	145, 474	29-4	482	29-14-26	483
28-106	146, 474	29-6-8	482	29-14-28	483
28-108	146, 474	29-6-10	482	29-14-30	483
28-109	146, 474	29-6-12	482	29-14-32	483
28-120	193, 474	29-6-14	482	29-14-34	483
28-122	193, 474	29-6-16	482	29-14-36	483
28-124	193, 474	29-6-18	482	29-18-16	483
28-128	193, 474	29-6-20	482	29-18-18	483
28-130	193, 474	29-6-22	482	29-18-20	483
28-131	194, 474	29-6-24	482	29-18-22	483
28-140	194, 474	29-6-26	482	29-18-24	483
28-150	475	29-6-28	482	29-18-26	483
28-151	475	29-6-30	482	29-18-28	483
28-152	475	29-6-32	482	29-18-30	483
28-153	475	29-6-34	482	29-18-32	483
28-196	477	29-6-36	482	29-18-34	483
28-200	477, 501	29-6-38	482	29-18-36	483
28-240	27, 478	29-6-40	482	29-32-8	484
28-244	478	29-8-8	482	29-32-10	484
28-280	479, 486	29-8-10	482	29-32-12	484
28-294	479	29-8-12	482	29-32-14	484



Numerical Index

CAT. NO.	PAGE	CAT. NO.	PAGE	CAT. NO.	PAGE
29-32-16	484	30-120	491	30-530-11	496
29-32-18	484	30-125	491	30-530-12	496
29-33-12	484	30-130	491	30-530-13	496
29-33-14	484	30-140	491	30-530-14	496
29-33-16	484	30-141	491	30-530-15	496
29-33-18	484	30-142	491	30-530-16	496
29-33-20	484	30-174	492	30-530-17	496
29-33-22	484	30-176	492	30-530-18	496
29-33-24	484	30-178	492	30-530-19	496
29-33-26	484	30-180	491	30-530-20	496
29-33-28	484	30-186	492	30-530-21	496
29-33-30	484	30-187	492	30-530-22	496
29-33-32	484	30-188	492	30-530-23	496
29-33-34	484	30-193	492	30-530-24	496
29-33-36	484	30-195	492	30-530-250	496
29-33-38	484	30-210	492	30-530-26	496
29-48	485	30-215	492	30-530-35	496
29-72	485	30-220	492	30-530-45	496
29-78	485	30-300	165, 493	30-530-55	496
29-80	485	30-305	165, 493	30-530-65	496
29-81	485	30-310	165, 493	30-530-75	496
29-102	486, 500	30-320	165, 493	30-530-85	496
29-232	487	30-325	165, 493	30-530-95	496
29-280	98, 487, 515	30-330	165, 493	30-530-105	496
29-282	98, 487, 515	30-340	165, 493	30-530-115	496
29-284	487	30-370	176, 494	30-530-125	496
29-286	487	30-395	166, 493	30-530-135	496
29-288	487	30-406	166, 493	30-530-145	496
29-290	487	30-415	166, 493	30-530-165	496
29-300	488	30-500	496	30-530-175	496
29-302	488	30-505-78	496	30-530-185	496
29-304	488	30-505-910	496	30-550	497
29-308	488	30-505-1112	496	30-555-34	497
29-310TC	128, 488	30-505-1314	496	30-555-56	497
30-10	489	30-505-1516	496	30-555-78	497
30-10B	489	30-505-1718	496	30-555-910	497
30-15	489	30-505-1920	496	30-555-1112	497
30-15B	489	30-505-2122	496	30-555-1314	497
30-20	489	30-505-2324	496	30-555-1516	497
30-20B	489	30-505-2526	496	30-555-1718	497
30-25	489	30-505-2728	496	30-560-1315	497
30-30	489	30-505-2930	496	30-560-1719	497
30-50	490	30-515	496	30-560-2123	497
30-55	490	30-520	496	30-560-2527	497
30-60	490	30-530-1	496	30-560-2931	497
30-62	490	30-530-2	496	30-560-3335	497
30-70	490	30-530-3	496	30-560-3739	497
30-75	490	30-530-4	496	30-560-4143	497
30-80	490	30-530-5	496	30-561	497
30-85	490	30-530-6	496	30-620	498
30-90	490	30-530-7	496	30-625	498
30-95	490	30-530-9	496	30-650	498
30-100	490	30-530-10	496	30-655	498

Numerical Index



CAT. NO.	PAGE	CAT. NO.	PAGE	CAT. NO.	PAGE
30-835	498	30-1270-3	507	30-2230	517
30-840	499	30-1270-4	507	30-2235	517
30-845	499	30-1275-1	507	30-2250	518
30-850	499	30-1275-4	507	30-2260	518
30-855	499	30-1350	507	30-2300	518
30-940	194, 500	30-1351	507	30-2305	518
30-950	194, 311, 500	30-1355	187, 507	30-2315	519
30-951	194, 500	30-1380	508	30-2320	519
30-952	194, 500	30-1382	508	30-2330	519
30-953	194, 500	30-1383	508	30-2335	519
30-954	194, 500	30-1385	508	30-2345	519
30-955	194, 500	30-1390	508	30-2350	520
30-965	500	30-1391	508	30-2355	520
30-970	500	30-1392	508	30-2390	520
30-975	500	30-1395	508	30-2400	520
30-985	501	30-1400	509	30-2410	521
30-988	501	30-1405	509	30-2415	521
30-990	501	30-1410	509	30-2430	521
30-997	502	30-1420	509	30-2435	522
30-998	502	30-1425	509	30-2445	522
30-1000	502	30-1430	509	30-2450	522
30-1005	502	30-1435	509	30-2505	110, 522
30-1010	502	30-1440	509	30-2530	523
30-1020	503	30-1442	510	30-2535	523
30-1025	107, 503	30-1443	510	30-2560	523
30-1030	107, 503	30-1445	510	30-2575	23, 523
30-1050-6	107, 503	30-1480	510	30-2580	23, 523
30-1050-8	107, 503	30-1482	511	30-2605	25, 523, 552
30-1050-10	107, 503	30-1485	511	30-2632	523
30-1077	503	30-1486	511	33-2	524
30-1150	505	30-1487	511	33-3	524
30-1160	505	30-1490	512	33-4	524
30-1185	505	30-1491	512	33-5	524
30-1190	505	30-1492	512	33-5A	524
30-1205-0	506	30-1493	512	33-5B	524
30-1205-00	506	30-1494	512	33-6	524
30-1205-1	506	30-1495	512	33-8	524
30-1205-2	506	30-1700	96, 513	33-10	524
30-1205-3	506	30-1710	96, 513	33-11	524
30-1205-4	506	30-1715	96, 513	33-11A	524
30-1205-5	506	30-1716	96, 513	33-12	524
30-1205-6	506	30-1718	96, 513	33-13	524
30-1225-1	506	30-1720	96, 513	33-14	524
30-1225-2	506	30-1730	97, 514	33-15	524
30-1225-3	506	30-1735	97, 514	33-16-0	524
30-1225-4	506	30-1740	97, 514	33-16.00	524
30-1225-5	506	30-1805	97, 211, 514	33-16-1	524
30-1225-6	506	30-1815	97, 211, 514	33-16-2	524
30-1255-2	506	30-2190	23, 516	33-16-3	524
30-1255-4	506	30-2195	23, 516	33-20	526
30-1255-6	506	30-2200	517	33-22	526
30-1270-1	507	30-2205	517	33-24	526
30-1270-2	507	30-2210	517	33-25	526



Numerical Index

CAT. NO.	PAGE	CAT. NO.	PAGE	CAT. NO.	PAGE
33-26	526	40-58/0	525	MS117-2	133
33-28	526	40-58/1	525	MS117-3	133
33-30	526	40-58/1-2	525	MS117-4	133
33-30-1	526	40-58/1-3	525	MS117-5	133
33-30-2	526	40-58/2	525	MS117-6	133
33-30-3	526	40-58/3	525	MS117-7	133
33-30-4	526	40-94	546	MS117-8	133
33-30-5	526	40-96	546	MS126-2	132
33-30-6	526	40-200	549	MS126-4	132
33-30-7	526	40-205	549	MS126-6	132
33-31	526	40-207	549	MS126-8	132
33-31A	526	40-210-CH	549	MS126-10	132
33-32	526	40-210-SS	549	MS126-12	132
33-33	526	40-212-CH	549	MS126-14	132
33-34	526	40-212-SS	549	MS126-16	132
33-35	526	40-215-CH	549	MS126-18	132
33-36	526	40-215-SS	549	MS126-20	132
33-37	526	40-217	549	MS126-22	132
33-40	527	40-219	549	MS140-0	132
33-121	194, 234, 311, 542	40-220	550	MS140-1	132
33-140	546	40-224	550	MS140-2	132
33-142	546	40-225-CH	550	MS140-3	132
33-200	547	40-225-SS	550	MS140-4	132
33-201	547	40-225A	550	MS140-5	132
33-202	547	40-228-CH	550	MS140-6	132
33-203	547	40-228-SS	550	MS140-7	132
33-204	547	40-228A	550	MS140-8	132
33-206	547	40-227-CH	550	MS140-9	132
33-210	547	40-227-SS	462, 550, 553	MS140-10	132
33-214	548	40-228	550	MS140-11	132
33-215	548	40-230	550	MS140-12	132
33-216	548	40-234	550	MS140-13	132
33-230	548	40-235	550	MS140-14	132
33-232	548	40-245-CH	551	MS140-15	132
33-234	548	40-245-SS	551	MS140-16	132
33-240	38, 332, 531	40-250-CH	551	MS140-17	132
33-242	38, 334, 531	40-250-SS	551	MS140-18	132
33-280	194, 542	40-251-CH	551	MS140-19	132
33-500	82, 548	40-251-SS	551	MS140-20	132
34-50	552	40-252	551	MS140A-1	132
34-52	552	40-260	50, 551	MS140A-2	132
34-80	50, 552	40-425	50, 551	MS140A-3	132
34-92	50, 552	40-435	50, 551	MS140A-4	132
34-98	50, 552	40-445	50, 551	MS140A-5	132
34-210	553	40-1235	164	MS140A-6	132
34-220	553	40-2000	316, 465	MS140A-7	132
34-250	194, 553	63-10	7, 349	MS140A-8	132
34-256	553	63-15	7, 349	MS140A-9	132
40-54	524	63-20	7, 349	MS140A-10	132
40-57/0	525	65-25	8	MS140A-11	132
40-57/1	525	73-62	308	MS140A-12	132
40-57/2	525	DELS23	308	MS140A-13	132
40-57/3	525	MS117-1	133	MS140A-14	132

Numerical Index



CAT. NO.	PAGE	CAT. NO.	PAGE	CAT. NO.	PAGE
MS140A-15	132	MS155-3	133	MS192A-7	131
MS140A-16	132	MS155-4	133	MS192A-8	131
MS140A-17	132	MS155-5	133	MS192A-9	131
MS140A-18	132	MS156-1	133	MS192A-10	131
MS140A-19	132	MS156-2	133	MS192A-11	131
MS140A-20	132	MS156-3	133	MS192A-12	131
MS140S-0	132	MS156-4	133	MS192A-13	131
MS140S-1	132	MS156-5	133	MS192A-14	131
MS140S-2	132	MS172-1	133	MS192A-15	131
MS140S-3	132	MS172-2	133	MS192A-16	131
MS140S-4	132	MS172-3	133	MS192A-17	131
MS140S-5	132	MS172-4	133	MS192A-18	131
MS140S-6	132	MS175-1	133	MS192A-19	131
MS140S-7	132	MS175-2	133	MS192A-20	131
MS140S-8	132	MS175-3	133	MS192S-0	131
MS140S-9	132	MS175-4	133	MS192S-1	131
MS140S-10	132	MS176-1	133	MS192S-2	131
MS140S-11	132	MS176-2	133	MS192S-3	131
MS140S-12	132	MS176-3	133	MS192S-4	131
MS140S-13	132	MS176-4	133	MS192S-5	131
MS140S-14	132	MS177	133	MS192S-6	131
MS140S-15	132	MS179-1	132	MS192S-7	131
MS140S-16	132	MS179-2	132	MS192S-8	131
MS140S-17	132	MS179-3	132	MS192S-9	131
MS140S-18	132	MS179-4	132	MS192S-10	131
MS140S-19	132	MS192-0	131	MS192S-11	131
MS140S-20	132	MS192-1	131	MS192S-12	131
MS141-0	131	MS192-2	131	MS192S-13	131
MS141-1	131	MS192-3	131	MS192S-14	131
MS141-2	131	MS192-4	131	MS192S-15	131
MS141-3	131	MS192-5	131	MS192S-16	131
MS141-4	131	MS192-6	131	MS192S-17	131
MS141-5	131	MS192-7	131	MS192S-18	131
MS141-6	131	MS192-8	131	MS192S-19	131
MS141-7	131	MS192-9	131	MS192S-20	131
MS141-8	131	MS192-10	131	MS431-4	133
MS141-9	131	MS192-11	131	MS431-3	133
MS141-10	131	MS192-12	131	MS431-2½	133
MS141-11	131	MS192-13	131	MS431-2½	133
MS141-12	131	MS192-14	131	MS431-2	133
MS150-1	131	MS192-15	131	MS431-1¾	133
MS150-2	131	MS192-16	131	MS431-1½	133
MS150-3	131	MS192-17	131	MS450-2/0	132
MS150-4	131	MS192-18	131	MS450-0	132
MS150-5	131	MS192-19	131	MS450-1	132
MS150-6	131	MS192-20	131	MS450-2	132
MS150-7	131	MS192A-0	131	MS450-6	132
MS153-1¾	132	MS192A-1	131	MS450-7	132
MS153-1¼	132	MS192A-2	131	MS450-8	132
MS153-1	132	MS192A-3	131	MS450-9	132
MS153-¾	132	MS192A-4	131	MS1274-2	134
MS155-1	133	MS192A-5	131	MS1274-4	134
MS155-2	133	MS192A-6	131	MS1274-5	134



Numerical Index

CAT. NO.	PAGE	CAT. NO.	PAGE	CAT. NO.	PAGE
MS1281-1	134	MS1291-1	134	MS1295-8	134
MS1281-2	134	MS1291-2	134	MSRC-14	133
MS1281-3	134	MS1291-3	134	MSRC-18	133
MS1281-4	134	MS1291-4	134	V96-329	84
MS1281-5	134	MS1291-5	134	V96-410	85
MS1281-6	134	MS1291-6	134	V97-584	12
MS1281-8	134	MS1295-1	134	V97-585	12
MS1282-1	134	MS1295-2	134	V97-588	12
MS1282-3	134	MS1295-3	134	V97-590	12
MS1282-4	134	MS1295-4	134	V97-591	12
MS1282-5	134	MS1295-5	134	V930-856	501
MS1282-6	134	MS1295-6	134	V930-996	499
MS1282-8	134	MS1295-7	134		

Notes





+HB34CATSMSURGOH

Availability of these products might vary from a given country or region to another, as a result of specific local regulatory approval or clearance requirements for sale in such country or region.

- Non contractual document. The manufacturer reserves the right, without prior notice, to modify the products in order to improve their quality.
- Warning: Applicable laws restrict these products to sale by or on the order of a physician.
- Consult product labels and inserts for any indication, contraindications, hazards, warnings, precautions, and instructions for use.

For more information or to place an order, please contact:

United States, Canada, Asia, Pacific, Latin America

USA 800-654-2873 • 888-980-7742 fax

International +1 609-936-5400 • +1 609-750-4259 fax

integralife.com

Manufacturer:



Integra LifeSciences Production Corporation

11 Cabot Boulevard

Mansfield, MA 02048 USA