

Integra[®] MicroFrance[®]
Integra ENT - Throat catalogue

Table of contents	ii	Tracheal retractor	16
Warranty and Customer Service Information	vi	Grooved director	16
Indications / Contraindications	vii	Curved scissors	16
Diagnosis	2	Micro surgery	17-18
Tongue depressor	2	Micro irrigation tube	17
Kilner mouth-gag	3	Micro vascular clamp	17
Davis-Boyle mouth-gag	4	Micro dissecting forceps	17
Mouth-gag, complete	5-6	Jeweler forceps	17
Morinière mouth-gag	7-9	Approximator	17
Presentation	7	Needle-holder	18
Composition of the mouth-gag	8	Micro scissors	18
Add-ins	9	Silicone cover	18
Tongue depressor	10	Suction tube with finger control	19
Tongue depressor with suction tube and basket	10	Micro suction irrigation tube	19
Tongue depressor with basket	10	Jankowski	19
Tonsil adenoid forceps	11	Lempert	19
Tonsil forceps with teeth	11	Wertheimer	19
Tonsil haemostatic forceps	11	Elevator - Raspatory	20
Adenoid forceps	11	Scalpel handle	21
Tonsil adenoid instruments	12-13	Curved raspatory	22
Scalpel handle	12	Other raspatory	23
Tonsil knife	12	Sharp raspatory	23
Blunt curette	12	Curved raspatory	23
Curved elevator	12	Straight raspatory	23
Double-ended elevator	12	Retractor	24-25
Suction tube with finger control	12	Sharp hook	24
Elevator and dissector	12	Double retractor	24
Monopolar elevator suction tube	12	Blunt retractor	24
Monopolar electrode pick	12	Sharp retractor, articulated	24
Monopolar cable	12	Retractor with prongs	25
Curved elevator	13	Large self-retaining retractor	26
Adenoid curette	14	Articulated self-retaining retractor	27
With basket	14	Malleable blade retractor - Double retractor	28
without basket	14	Blunt retractor - Double retractor	29
Tonsil snare, Amygdalotome	15	Small scissors, pointed, matt finish	30
Amygdalotome, tonsil blade	15	Long scissors, pointed	31
Amygdalotome, handle	15	Small scissors, blunt, matt finish	32
Tonsil snare	15	Long curved scissors, blunt	33
Snare wire	15	Small Metzenbaum scissors, matt finish	34
Stainless steel wire	15	Large Metzenbaum scissors	35
Neck surgery	16	Mayo scissors, matt finish	36
Facial nerve dissector	16		
Tracheal dilator	16		
Curved dissector	16		
Shear	16		

Fine dissecting forceps	37	Diverticuloscope	56
with teeth and platform	37	Suction tube	56
with serrated jaws	37	Fiber	56
with teeth	37		
Adson dissecting forceps	38	Laryngoscope holder, Cold Light	57
		Laryngoscope holder	57
		Plate for Chest holder	57
		Operating table clamp	57
		Cold light cable	57
		Adapter for cold light cable	57
Medium dissecting forceps	39-40	Open laryngoscope	58
with serrated jaws	39-40	Laryngoscope without suction tube	59
with teeth	39-40	Laryngoscope with suction tube	60
with teeth and platform	39-40	Sataloff laryngoscope	61
		Micro suction tube	62
Dissecting forceps, 180mm	41	Suction tube	62
		Blunt eyes suction tube	62
Dissecting forceps, 200mm	42	Insulated suction tube with finger control	62
		Suction tube with finger control	62
Medium bipolar dissection forceps	43	Sataloff suction tube	62
Bipolar dissecting forceps, 200mm	44	Bouchayer Instruments	63
Irrigation bipolar forceps	45	Forceps, serrated jaws	63
		Heart-shaped forceps	63
Medium monopolar dissecting forceps	46	Cup forceps	63
Adson	46	Bouchayer Instruments, Working length 220mm	64
with smooth jaws	46	Micro laryngeal scissors	64
with serrated jaws	46	Lancet knife	64
with teeth	46	Lancet knife, handle and 3 blades	64
Monopolar cable	46	Micro laryngeal elevator	64
		Micro retractor forceps	64
Large monopolar dissecting forceps	47	Needle-holder	64
Needle-holder, tungsten jaws	48	Pérouse Instruments, Working length 220mm	65
Large tungsten needle-holder	49	Micro laryngeal elevator	65
		Stylet handle	65
Fine haemostatic forceps	50	Tungsten needle-holder insert	65
Medium haemostatic forceps	51	Abitbol Instruments	66
Strong haemostatic forceps	52	Insulated suction tube with finger control	66
With teeth, «T» tip	52	Monopolar forceps with suction	66
with serrated jaws	52	Monopolar cable	66
Other haemostatic forceps	53	Other laryngeal instruments	67-68
Esophagoscope	54	Scalpel handle	67
Esophagoscope	54	Knife blade	67
Fiber	54	Stylet handle	67
Handle	54	Tungsten needle-holder insert	67
Suction tube	54	Adapter for cleaning insert	67
Forceps	54	Needle-Holder, tungsten jaws	67
Sterilization case	54	Sickle knife	67
Hypopharyngoscope	55		
Hypopharyngoscope	55		
Fiber	55		
Suction tube	55		
Forceps	55		
Diverticuloscope	56		

Knife	67	Henry set - 3.0mm	75
Hook	67	Scissors	75
Retractor	67	Monopolar hook	75
Knife	68	Palpation probe	75
Micro scissors	68	Forceps, fenestrated jaws	75
Laryngeal sprinkler	68	Forceps, alligator serrated jaws	75
Injection needle	68	Trocar	75
Double probe	68	Trocar holder ring	75
Micro coagulation	69	Terris thyroidectomy Instrument Set - Robotic thyroid surgery	76
Monopolar suction tube with finger control	69	Double retractor	76
Monopolar electrode pick	69	Curved elevator	76
Monopolar cable	69	Peanut holder	76
Bipolar forceps	69	Malleable suction tube elevator	76
Bipolar cable	69	Robotic thyroid surgery	76
Micro injection	70	Mini invasive instrumentation Ø 3.5mm	77
Casiano transcervical laryngeal injection	70	Metallic trocar with silicone valve	77
Pistol for injection	70	Metallic trocar with magnetic valve	77
Luer-lock adapter	70	Pediatric Instrumentation Ø 3.5mm	78-86
Injection needle	70	Composite trocar with silicone valve	78
Sataloff instruments	71-72	Suction irrigation tube	79
Injection needle	71	Retractable knife	79
Micro knife	71	Monopolar hook	79
Micro blunt hook	71	Bipolar forceps	80
Micro curette for cyst	71	2-piece : Insert Jaws with insulated tube	81
Micro spatula	71	Cleaning adapter	81
Micro hook	71	Angled handle	82
Mirror	71	Axial handle	83
Micro ball dissector	71	Ergonomic handle	84
Instrument holder	71	Scissors, 1-piece	85
Cotton carrier	71	Forceps, 1-piece	85
Cup forceps	72	De Lagausie instruments	86
Heart-shaped grasper	72	Needle-holder	86
Alligator forceps	72	Stainless steel cup, Tray	87
Sataloff indirect Laryngeal instruments	73	Stainless steel sterilization case	88
Injection needle	73	Plastic sterilization case	89
Laryngeal dilator	73	Large plastic sterilization case	90
Micro suction tube	73	Numerical index	91
Micro knife	73	Table for corresponding manufacturer part numbers For information purposes only	99
Micro scissors	73		
Micro vascular knife	73		
Micro forceps	73		
Instrument holder	73		
Stainless steel sterilization case	73		
Benninger instruments	74		
Scissors	74		
Cup forceps	74		
Heart-shaped grasper	74		
Needle-holder	74		
Knot pusher	74		

Integra Limited Warranty

Please refer to the warranty included in the packaging of each product to know the applicable warranty.

Contacts Customer service:

International

+33 (0) 4 37 47 59 50
+33 (0) 4 37 47 59 25 (fax)
csemea@integralife.com

France

+33 (0) 4 37 47 59 10
+33 (0) 4 37 47 59 29 (Fax)
custservfrance@integralife.com

Belgium & Luxembourg

+32 (0) 2 257 4130
+32 (0) 2 253 2466 (Fax)
custsvcbenlux@integralife.com

United Kingdom

+44 (0) 1264 312 725
+44 (0) 1264 312 821 (Fax)
custsvcs.uk@integralife.com

Netherlands

+31(0) 852 083 167
+31(0) 207 093 627 (Fax)
custsvcnetherlands@integralife.com

Italy

+39 (0) 2 577 8921
+39 (0) 2 575 113 71 (Fax)
custsvcitaly@integralife.com

MicroFrance® ENT Instrumentation

INDICATIONS

- All the medical devices showed in this catalogue have indications for diagnosis and/or ENT surgery.
- Sizes are not contractual and are given for information purposes only.

CONTRAINDICATIONS

- Do not use in indications other than the indications mentioned in the DFU or Labeling.

How to read the catalogue

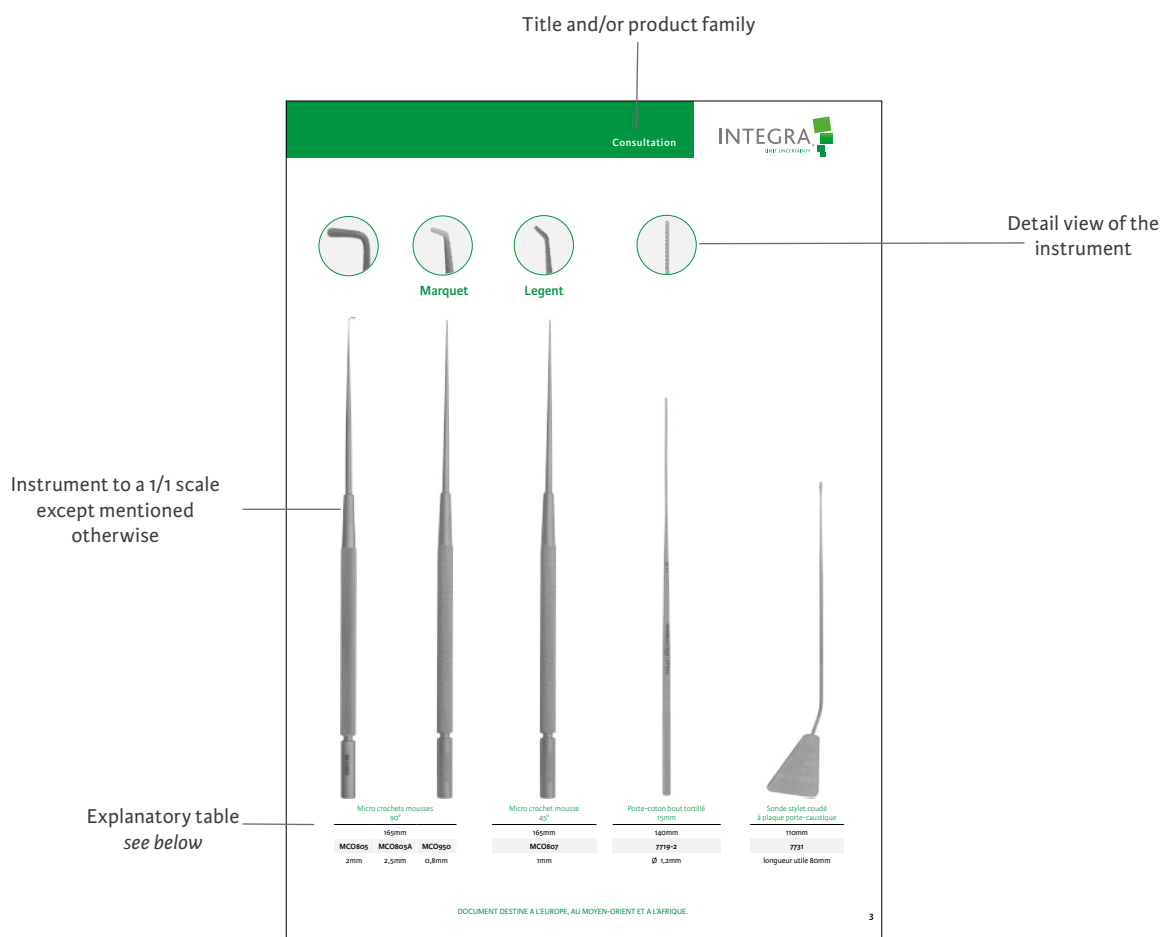

Explanation of the table reference and complementary product description

Title or subtitles	
Global complementary description	
Product ref.1	complementary description 1
Product ref.2	complementary description 2

Tongue depressor

Doyen



Double

150mm - Pack 10

7798T^(D)*

Doyen



Double

150mm - Pack 10

7798T1^(D)*

Canuyt



Fenestrated

185mm

7796

^(D) Distributed by Integra MicroFrance SAS (France) - For corresponding manufacturer part numbers, see table in annex
*Please check with your sales representative availability of this product in your country

Scale 2/3



Kilner

Ring blade

7803S-3	7803S-2	7803S-1
40x75mm n°3	35x70mm n°2	30x60mm n°1



Kilner

Frame

7803C



Palatine blade

7803B

without fixing upper jaw



Camo® dental mouth guard

7960T40^(D)

Pack 40 - Single use



Chabolle

Ring blade

MCR3A	MCR2A
40x90mm n°3	40x80mm n°2



Silicone dental mouth guard

7802P

Pack 2

^(D) Distributed by Integra MicroFrance SAS (France) - For corresponding manufacturer part numbers, see table in annex
*Please check with your sales representative availability of this product in your country



Davis-Boyle

Frame
7802C



Camo® dental mouth guard
7960T40^(D)*
Pack 40 - Single use



Silicone dental mouth guard
7802P
Pack 2



Davis-Boyle

Blade with suction tube

7802S-5	7802S-4	7802S-3	7802S-2	7802S-1
20x105mm n°5	25x90mm n°4	25x75mm n°3	25x60mm n°2	20x25mm n°1

^(D) Distributed by Integra MicroFrance SAS (France) - For corresponding manufacturer part numbers, see table in annex
*Please check with your sales representative availability of this product in your country

Scale 1/2

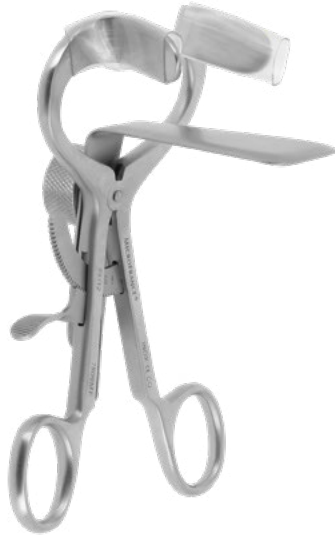

Masson

7809MF

140mm



7821B

Doyen

7821B

7821A

120mm

140mm

Scale 1/2

Seemann-Seiffert

7805-11	7805-13
110mm	130mm



Jennings

7804-9	90mm
7804-11	110mm
7804-13	130mm

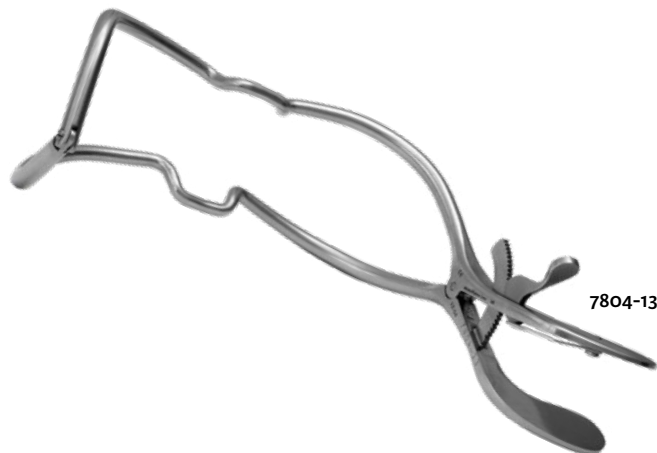

Presentation of Morinière mouth-gag for mini invasive surgery

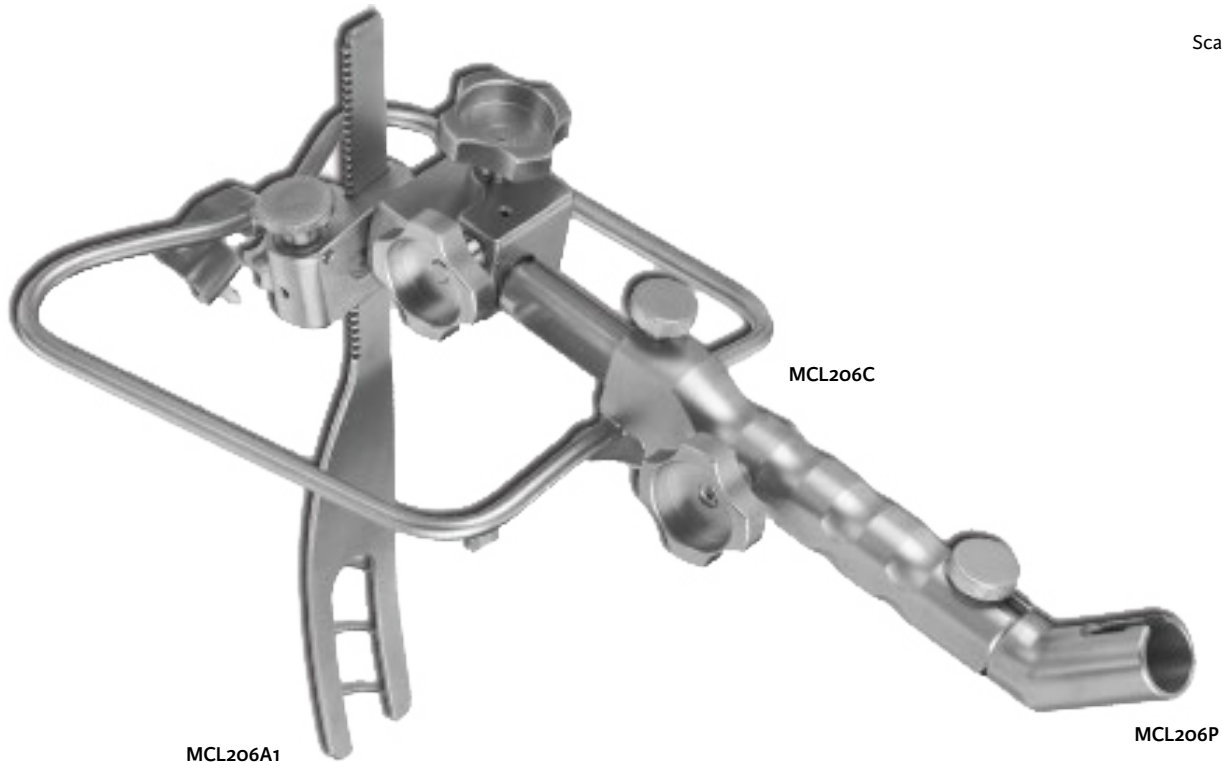
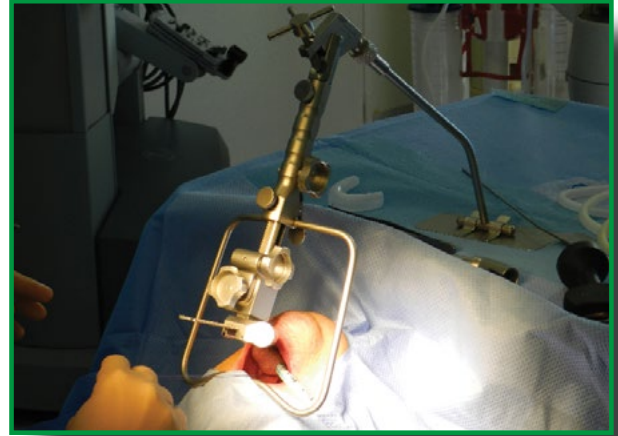
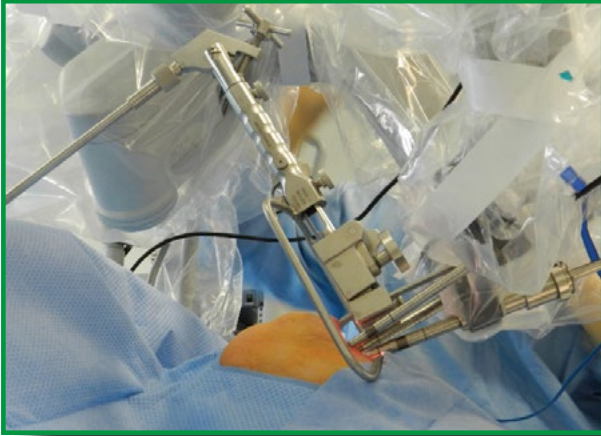

Scale 1/2

Frame MCL206C
with ring blade MCL206A1
and adapter MCL206P

Composition of the mouth-gag

Scale 1/3

MCL2o6

Mouth-gag, mini invasive surgery, complete with 1 frame, 5 blades, 1 locking key and 1 angled intermediate piece.

Frame

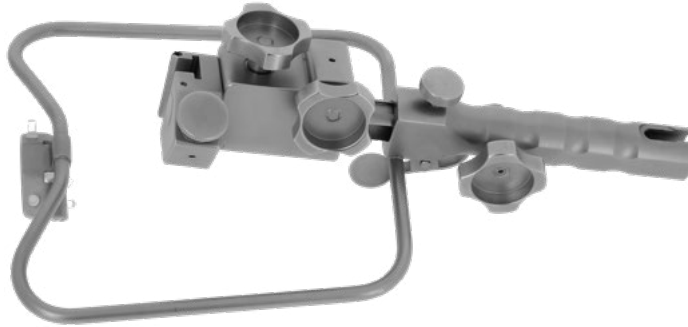

MCL2o6C

Blade

MCL2o6A1 35x120mm ring blade



MCL2o6A2 35x120mm



MCL2o6A3 35x110mm



MCL2o6A4 40x85mm



MCL2o6A5 35x65mm



Locking key

Angled intermediate piece

MCL2o6K



MCL2o6P



Additional accessories, not included in ref. MCL2o6

MCL2o6A6 larynx blade 140x20mm



MCL2o6A7 Zenker's diverticulum blade 180x23mm



Add-ins instruments

Picture for information, without scale

Dental mouth guard

7802P Silicone dental mouth guard (Pk 2)

7960T40^{(D)*} Camo® dental mouth guard Single use - (Pk 40)



Fiberoptic

MCL38N^{(D)*} Fiberoptic, 2200mm without adapter

Adapters

MCL170^{(D)(i)*}

Wolf

MCL171^{(D)(i)*}

MCL173^{(D)(i)*}

Storz

MCL174^{(D)(i)*}

MCL197^{(D)(i)*}

Olympus

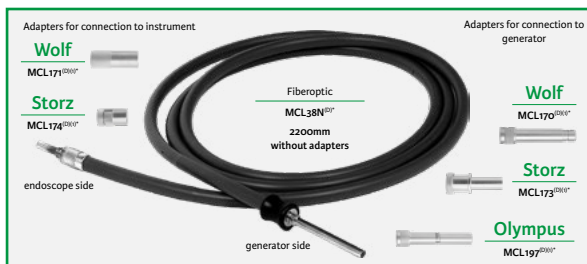

⁽ⁱ⁾ Not a medical product

Light fiber

MCL89-2 Light fiber



Chest holder

MCL76 Laryngoscope arm holder without MCL35



MCL35 Plate for chest holder

Suction tube

MCL89-1 Suction tube for MCL206



MCL100 Blunt eyes suction tube



Container

7874MF-34 Stainless steel sterilization case 380x205x85mm 340x200x80mm

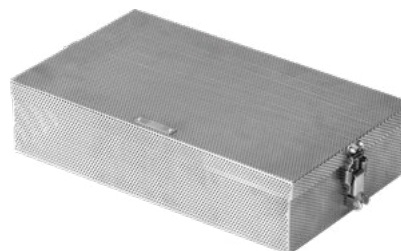

Silicone cover

MCM25-3 Silicone cover

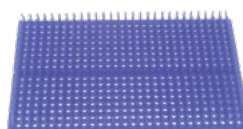

^(D) Distributed by Integra MicroFrance SAS (France) - For corresponding manufacturer part numbers, see table in annex
*Please check with your sales representative availability of this product in your country

Portmann

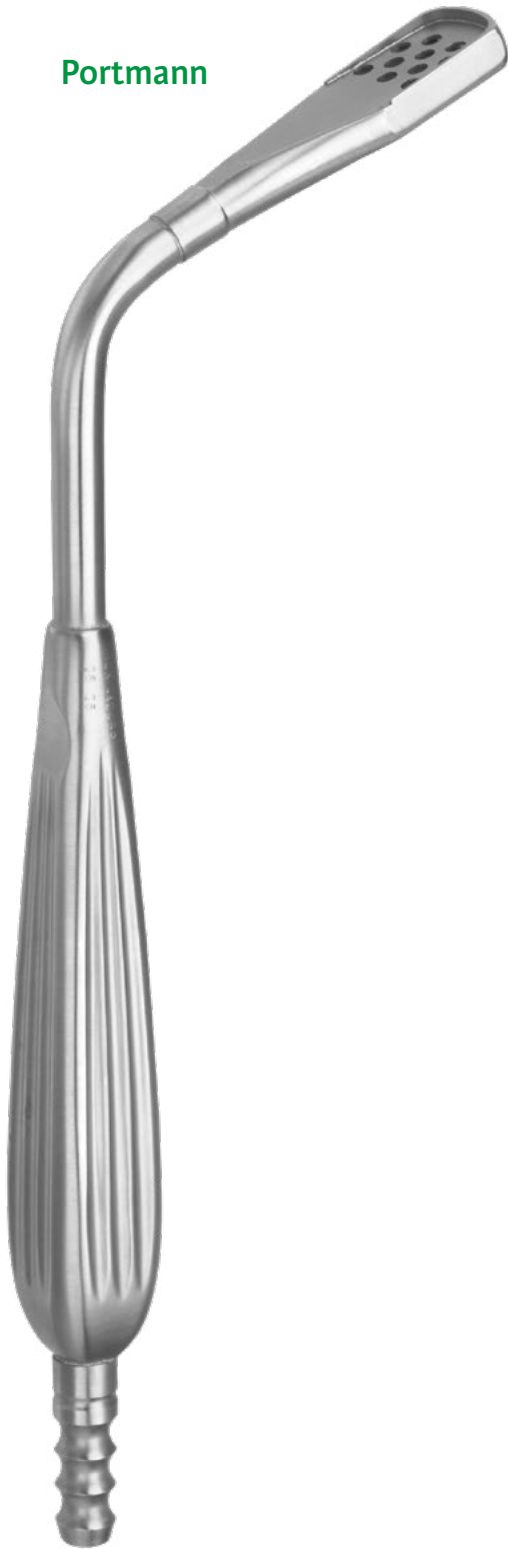

200mm

7857

Lecouteur



160mm

7800MF

Le Mée



7797-2

170mm

7797-1 small

7797-2 large

Scale 1/2

Birkett



200mm
7823

Schmidt



open ring

190mm
7822

Négus



200mm
7825

Bourgeois



200mm
7819

Portmann



open ring

200mm
7820

Chatelier



210mm
7826-1-7

Scale 1/2

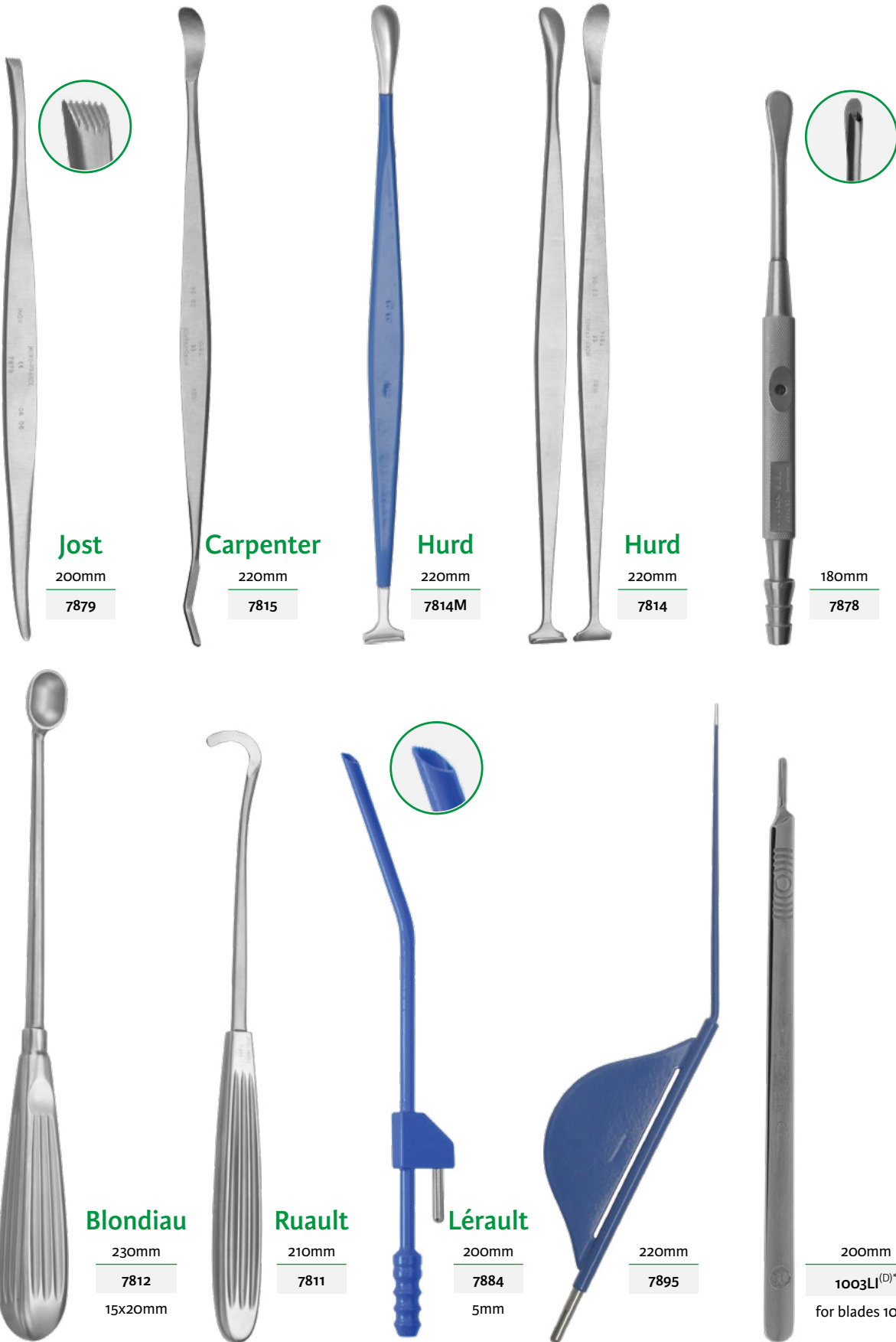

Jost
200mm
7879

Carpenter
220mm
7815

Hurd
220mm
7814M

Hurd
220mm
7814

180mm
7878

Blondiau
230mm
7812
15x20mm

Ruault
210mm
7811

Lérault
200mm
7884
5mm

220mm
7895

200mm
1003LI^{(D)*}
for blades 10/15

Monopolar cables
3.5m

CP391E
Erbe ACC ICC/VIO
Storz Wolf

CP391M
Aesculap Berchtold
Lamidey
Martin Erbe T Serie
Sutter BM-780 II

CP391V
Bowa Bovie
Conmed Valleylab

^(D) Distributed by Integra MicroFrance SAS (France) - For corresponding manufacturer part numbers, see table in annex
*Please check with your sales representative availability of this product in your country

Hurd

Elevator
225mm

3734042



Scale 2/3

Moure



7828-1-13

Moure



7828-16

Lermoyez



7829-10

220mm - without basket



7828-1-10 6/10mm



7828-1-13 8/13mm

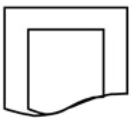

7828-1-16 10/16mm



7828-1-19 12/19mm

220mm - with basket



7828-10 6/10mm



7828-13 8/13mm

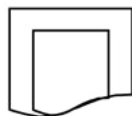

7828-16 10/16mm



7828-19 12/19mm

220mm - without basket



7829-10 5/10mm

7829-13 7/13mm

7829-16 9/16mm

7829-19 13/19mm

Scale 1/2

Working length «L»

Sluder

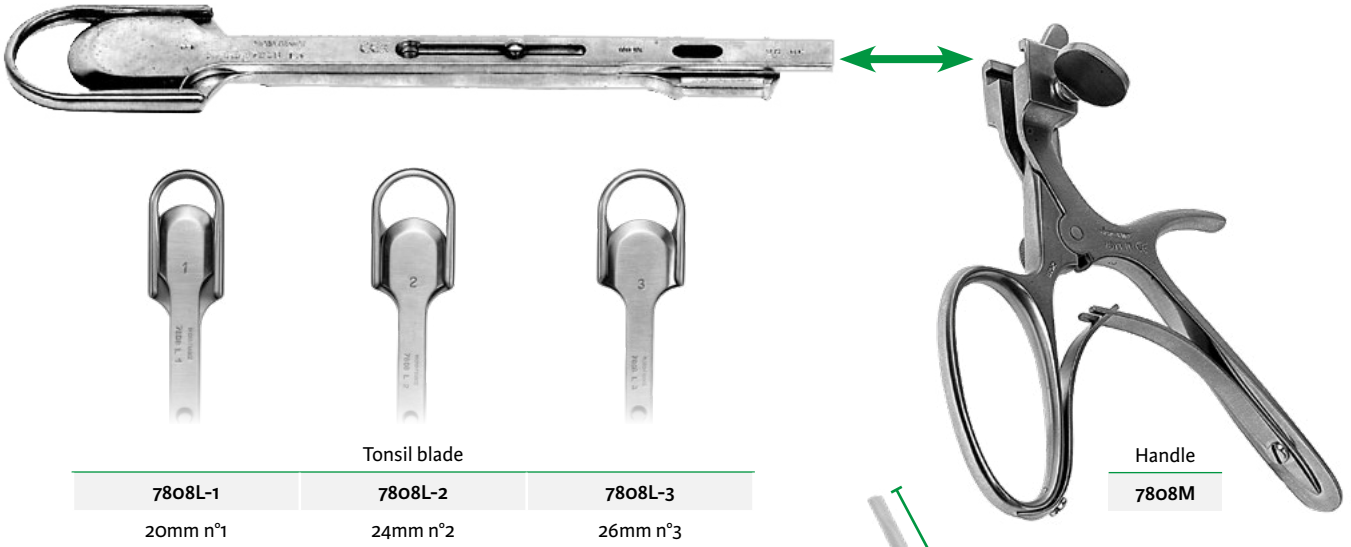

Tonsil blade		
7808L-1	7808L-2	7808L-3
20mm n°1	24mm n°2	26mm n°3

Handle
7808M

Brünings

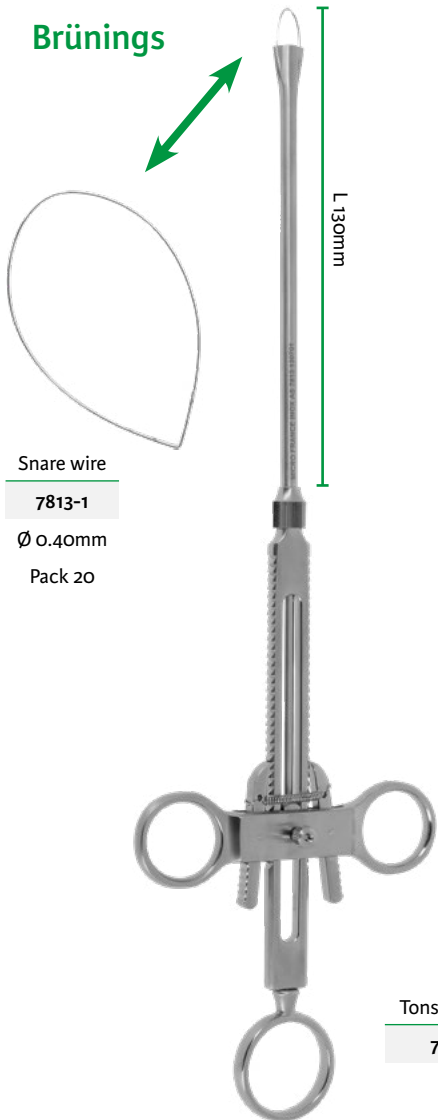

Snare wire
7813-1
Ø 0.40mm
Pack 20

Tonsil snare
7813

Vacher

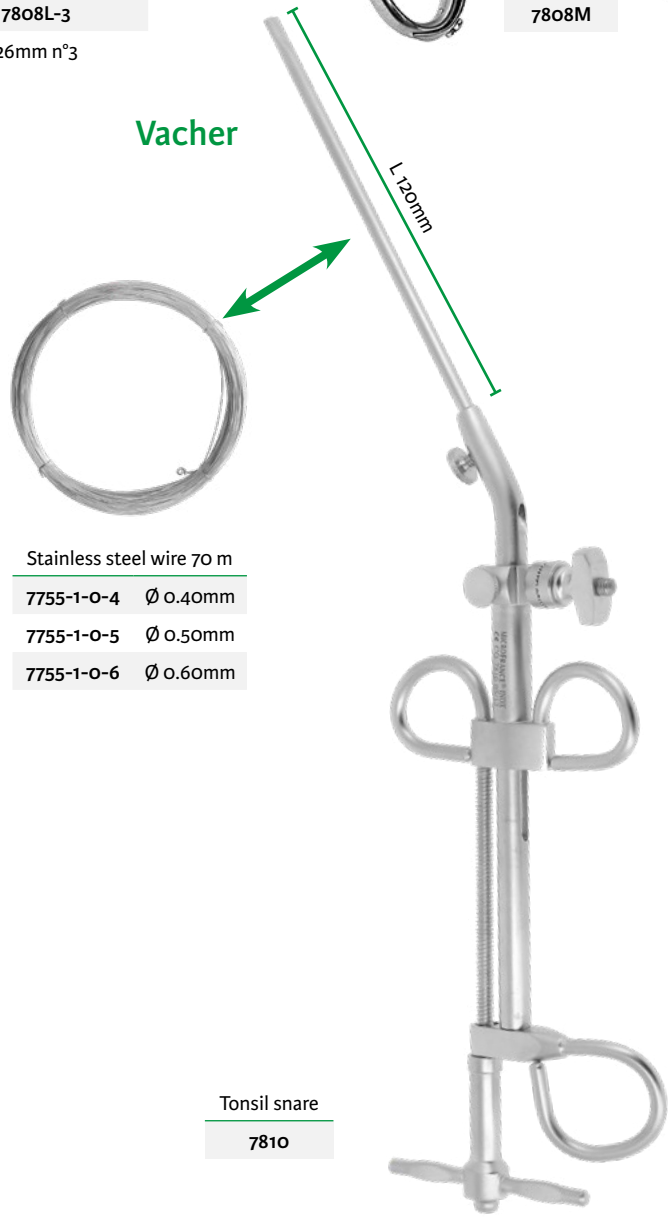

Stainless steel wire 70 m
7755-1-O-4 Ø 0.40mm
7755-1-O-5 Ø 0.50mm
7755-1-O-6 Ø 0.60mm

Tonsil snare
7810

Laborde



Tracheal dilator

7840

120mm 80°

Guerrier



Tracheal retractor

7838

180mm

Marie



Director

7839

145mm



Facial nerve dissector

7830M

160mm

Moure



Shear serrated blades

7835

200mm

Guerrier



«S» curved scissors

7921

180mm

O'Shaughnessy



Curved dissector

7837-18

180mm

Redon



7920

140mm

Working length «L»

Micro irrigation tube



MCM10-0-5 Ø 0.5mm L 30mm
MCM10-1-0 Ø 1mm

Approximator L 13mm

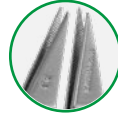

Large

MCM13

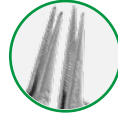

Small

MCM13-1

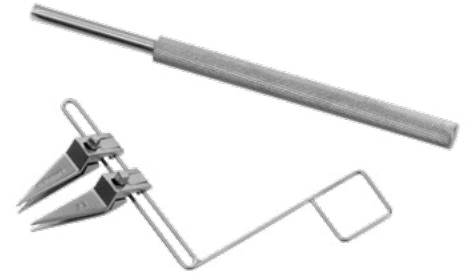

MCM13

Gilbert O'Brien

Micro dissecting forceps - 150mm



MCM4BISR

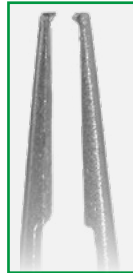

MCM4BISR

1x2 teeth and platform

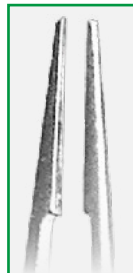

MCM4R

Smooth jaws with plate

Jeweler forceps



130mm

MCM973D3 n°3

MCM973D5 n°5

Micro scissors

Vanas



MCM7BISR

8mm
Blunt curved

Vanas



MCM7R

8mm - serrated
straight blades



MCM970

8mm
atraumatic curved



MCM7BISR
150mm

Micro needle-holder

O'Brien



MCM12R

5x0.3mm
smooth curved jaws

Barraquer-Comtet



MCM1R

8mm
smooth straight jaws



MCM12R
150mm

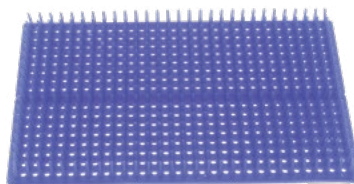

MCM25-3

210x130mm

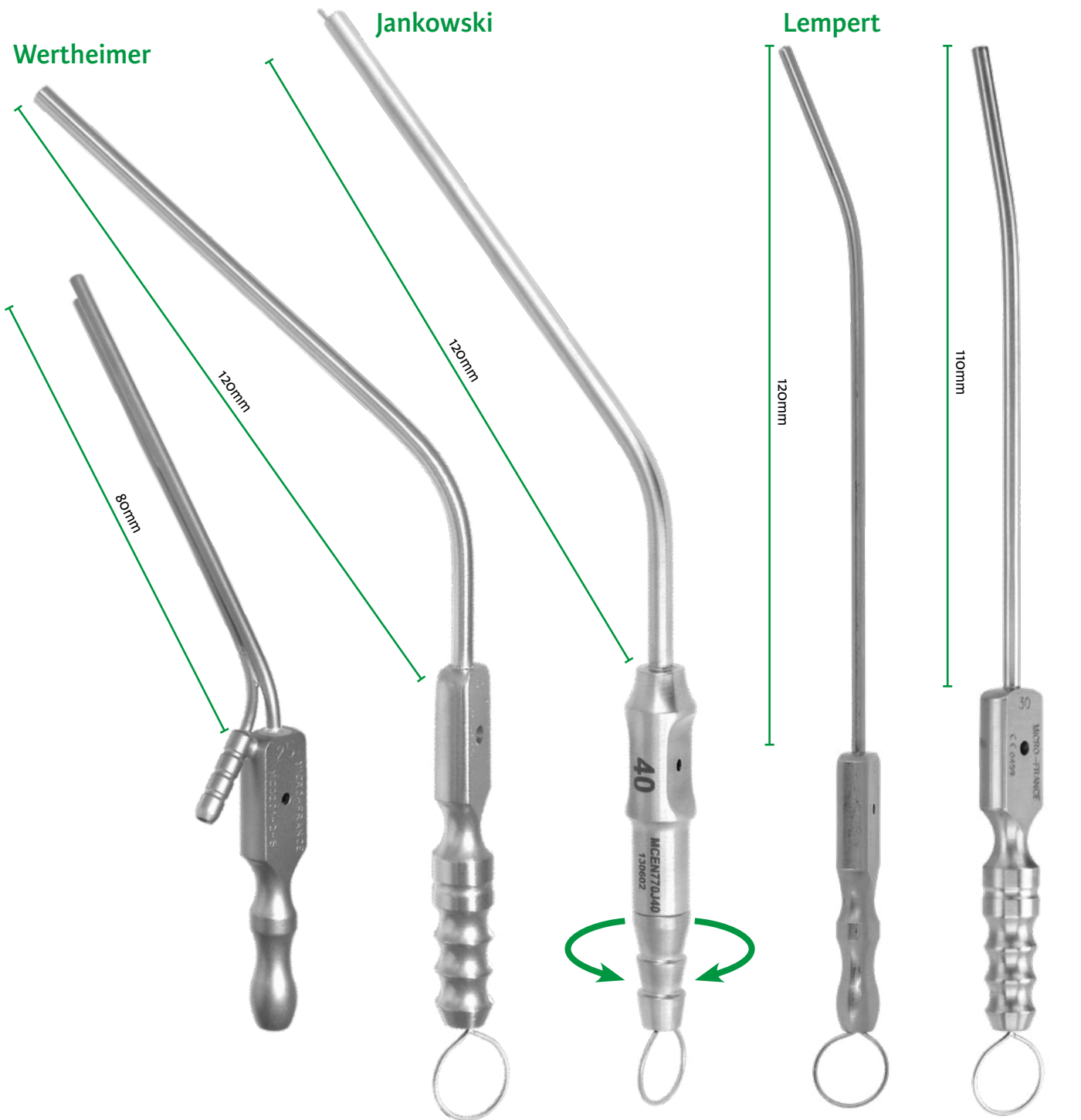

- 1.5mm
- 2mm
- 2.5mm
- 3mm
- 3.5mm
- 4mm

Wertheimer	
MCO201-2-5	2.5mm
MCO201-3-0	3mm

Wertheimer	
MCO770-1-5	1.5mm
MCO770-2-0	2mm
MCO770-2-5	2.5mm
MCO770-3-0	3mm
MCO770-3-5	3.5mm
MCO770-4-0	4mm

Jankowski	
MCEN770J40	4mm
MCEN770J30	3mm

Lempert	
MCO771-2-5	2.5mm
MCO771-3-0	3mm
MCO771-4-0	4mm

CP330-3-0	3mm
CP330-4-0	4mm

Sébileau



190mm
CP985
5mm

Fleury



180mm
MCO305
8.5mm

Freer



160mm
MCO803
2.5mm

Howarth



185mm
CP611
5mm

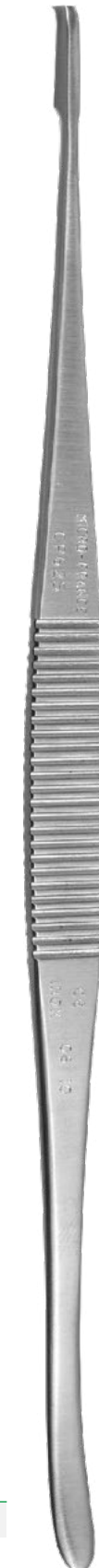

220mm
CP625

Cottle



220mm
CP626

McKenty



240mm
CP627



120mm

160mm

200mm

150mm

120mm

1003IG^{(D)*}

1005I^{(D)*}

1003LI^{(D)*}

CP821

1004IG^{(D)*}

N° 3

N° 7

N° 3L

N° 3

N° 4

For blades 11/15

For blades 23

^(D) Distributed by Integra MicroFrance SAS (France) - For corresponding manufacturer part numbers, see table in annex
*Please check with your sales representative availability of this product in your country

Farabeuf

Fleury

Sébileau

Plester



150mm

7787-10

10mm



170mm

MCO979

6,5mm



150mm

CP825

4mm



180mm

MCO988

7,5mm



195mm

3724059

6,5mm

Joseph

Obwegeser



180mm

CP310

5mm



180mm

CP310D

5mm
straight



180mm

CP310E

4mm

CP310



CP344A

Obwegeser

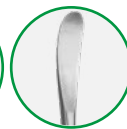
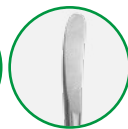

180mm

CP344A

5mm

CP344B

7mm

CP344C

11mm

Obwegeser-Tessier

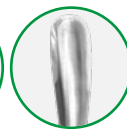
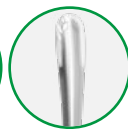

180mm - sharp

CP344AT

5mm

CP344BT

7mm

CP344CT

11mm

Obwegeser



190mm

CP344D

7mm
curved

CP344E

7mm
very curved

Obwegeser-Tessier



190mm - tranchante

CP344DT

7mm
curved

CP344ET

7mm
very curved

Farabeuf



140mm	120mm
7768-1	7768
Pk 2	Pk 2

Desmarres



140mm
CP822-12
12mm
CP822-10
10mm
CP822-14
14mm

Gillies



180mm
CP17
3mm
CP17-1
2mm

Gillies



145mm
CP17-3
2mm
CP17-2
3mm

Humby



145mm
CP628
5mm

110mm
CP941
articulated

Knapp



150mm

3714027

8mm

3714028

blunt



140mm

CP21-3

pointu

CP21A-3

blunt

Volkman



150mm

7782-1-2



180mm

CP335

Senn-Miller



160mm

CP609

3 sharp prongs

Weitlaner



curved

160mm

0-28-7

sharp prongs

Bizeau

165mm

MCL359

blades 20x30mm

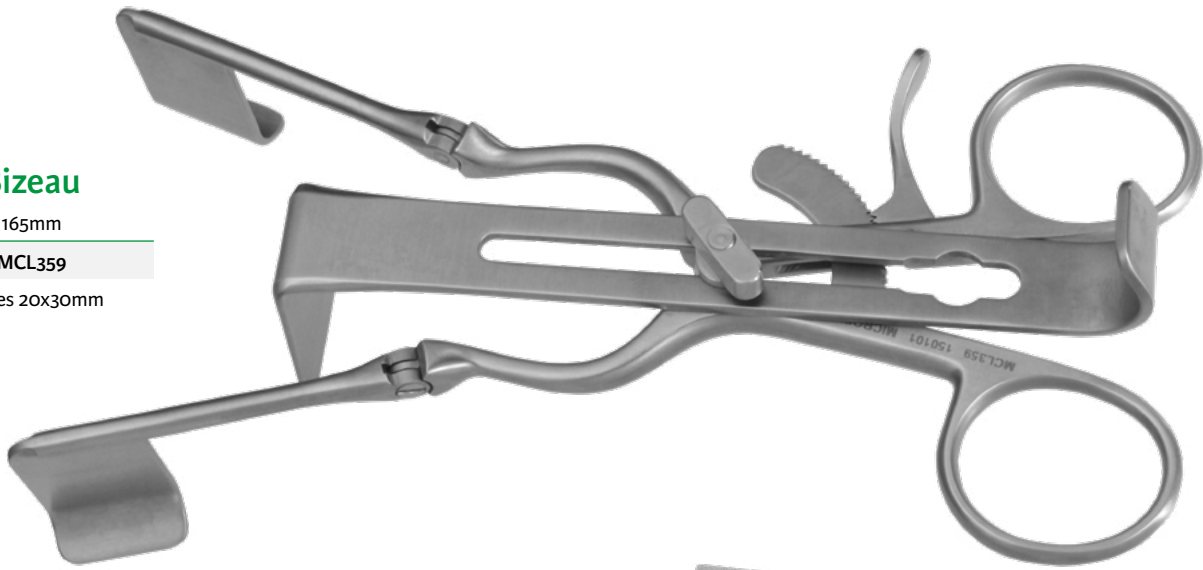

Weitlaner-Beckmann

165mm

7781



Malleable



8mm	10mm	12mm	15mm	20mm
CP818-8	CP818-10	CP818-12	CP818-15	CP818-20



210mm

CP818-8

Dautrey



15x40mm

15x55mm

140mm

CP984

Dautrey



15x60mm

15x85mm

140mm

CP984-1

Malleable



10mm

15mm

Blade retractor
10/15mm - 160mm

7773

Scale 2/3



200mm

CEV418

Pack 2

Descottes



200mm

CEV417

Pack 2

Mosnier

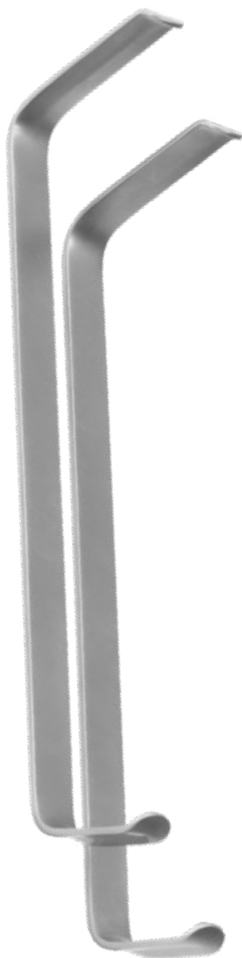

160mm

CEV419

Pack 2

Pessey



180mm

CP335P

Leroux-Robert

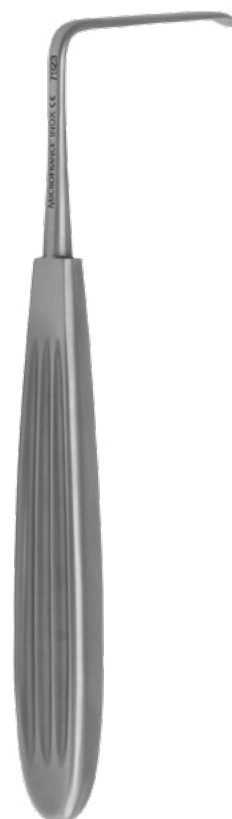

160mm

7923

Scale 3/4

Streiff



CP16-1

105mm

CP16-1	CP16
curved blades	straight blades



100mm

CP353
Strong curvature

Offret



100mm

CP356

Joseph



CP354A

120mm

CP354A	CP354
curved blades	straight blades

Joseph



CP919A

110mm

CP919A	CP919
curved blades	straight blades

Fox



CP358A

110mm

CP358A	CP358
curved blades	straight blades

Kilner-jost



120mm
CP362
Curved

Boetcher



180mm
CP997
Curved

Brophy



CP367-1

150mm
CP367-1 CP367
Curved Straight

Joseph

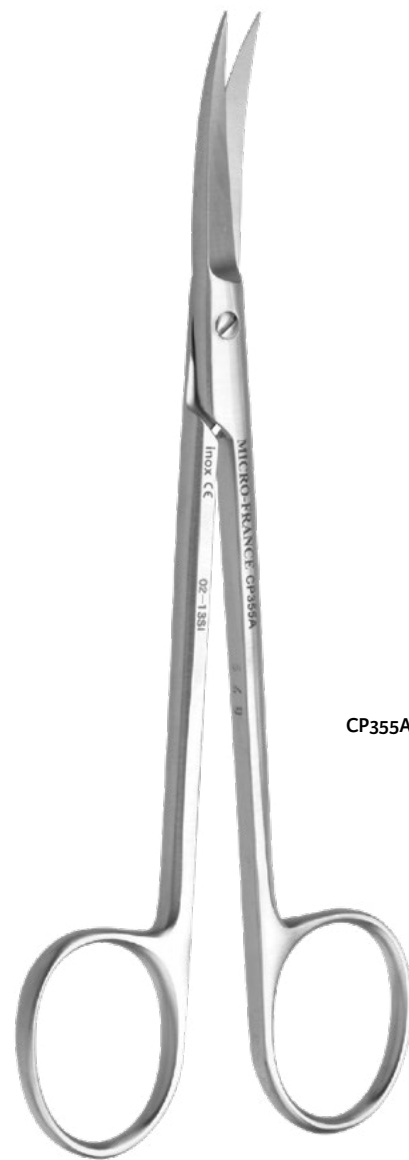

CP355A

150mm
CP355A CP355
Curved Straight

Scale 3/4

Shea



120mm

CP637

curved blades

Bregat



110mm

CP363

curved blades

Stevens



110mm

CP922A

curved tenotomy scissors

Stevens



110mm

CP922

straight blades

Stevens



115mm

CP922B

curved tenotomy scissors

Reynolds

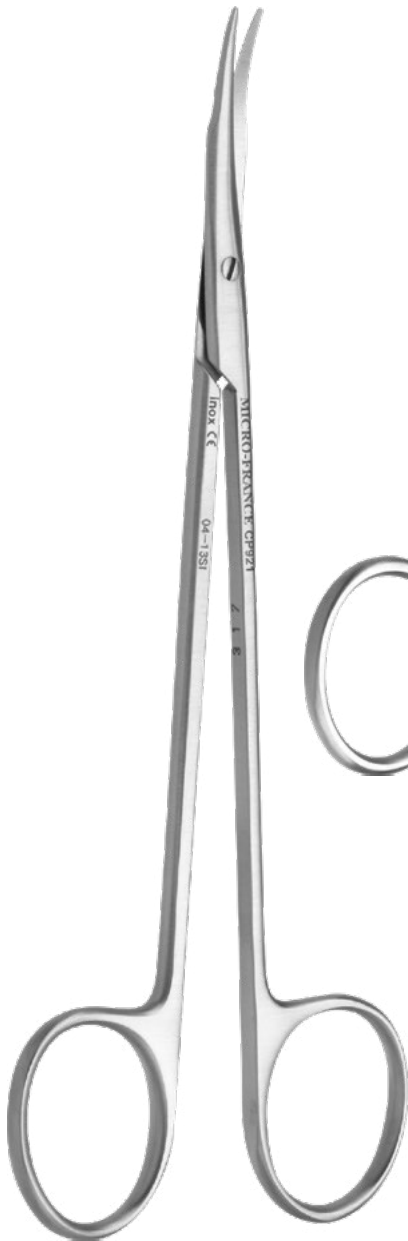

160mm

CP921

Ragnell



150mm

CP616-15



130mm

CP616-13

Joseph



150mm

CP355C

Léger



150mm

CP365

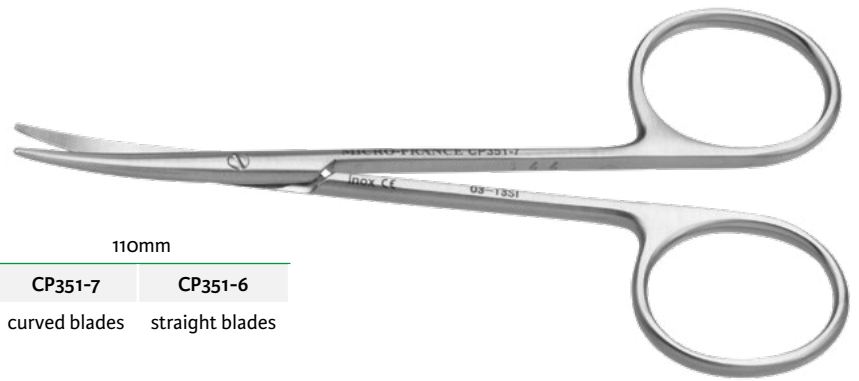

110mm

CP351-7	CP351-6
curved blades	straight blades

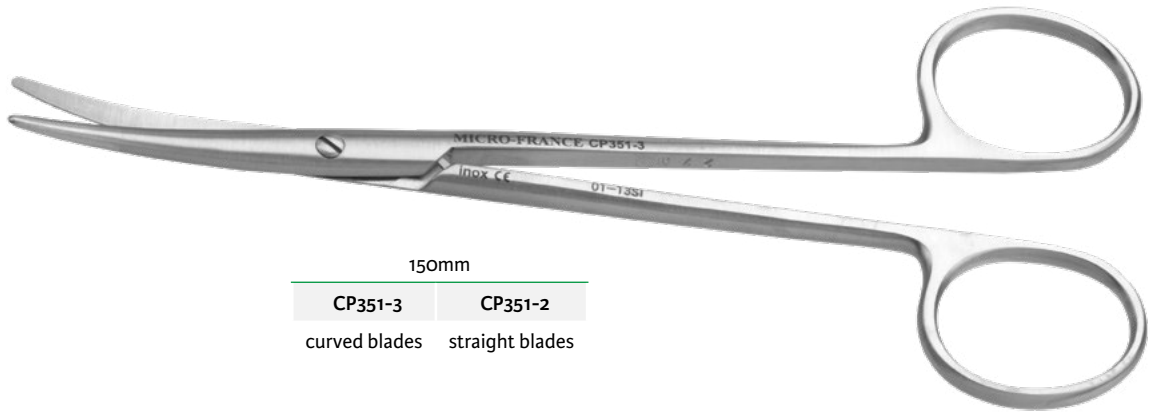

150mm

CP351-3	CP351-2
curved blades	straight blades

Delicate blades

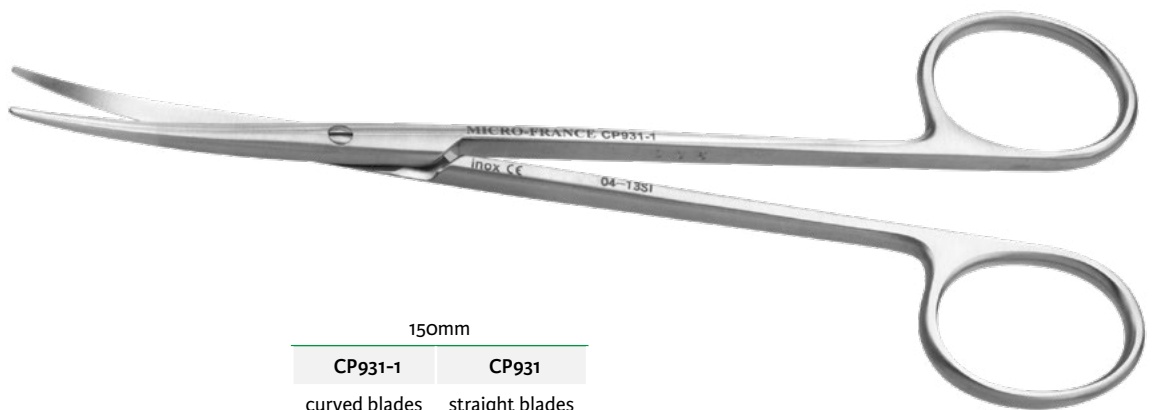

150mm

CP931-1	CP931
curved blades	straight blades



CP351-5

Curved standard

CP351-5	CP351-1
200mm	180mm



CP931-5

Curved, delicate blades

CP931-5	CP931-3
200mm	180mm



170mm
CP352-2
straight blades



150mm
CP352
straight blades



170mm
CP352-3
curved blades



150mm
CP352-1
curved blades

Dissecting forceps 110mm

Castroviejo



CP938-1

Horizontal 1x2 teeth and platform

Castroviejo



CP37

Oblique 1x2 teeth and platform



CP332

Serrated jaws 1.4mm

Dissecting forceps 120mm



serrated jaws

CP414

Jaws 1mm



7831A-12

Jaws 1.5mm



CP406

1x2 teeth - Jaws 1mm



Jaws with teeth

7833A-12

1x2 teeth - Jaws 1.5mm



CP400-1

5x5 griffes

150mm

Adson



CP604-15 serrated jaws 1.5mm

CP605-15 1x2 teeth 1.5mm jaws

Adson-Brown



CP606-15 7x7 teeth

120mm



Adson-Tubiana

Jaws 1mm

M832
serrated



Adson

Jaws 1.5mm

CP604
serrated

CP605
1x2 teeth



Jaws 1.5mm

CP606A
tungsten serrated



Adson-Brown

Jaws 7x7 teeth

CP606

Mac-Indoe

140mm



CP934
Oblique
1x2 teeth
and
serrated
platform

CP934-1
Serrated
jaws

Debaquey

Barraya

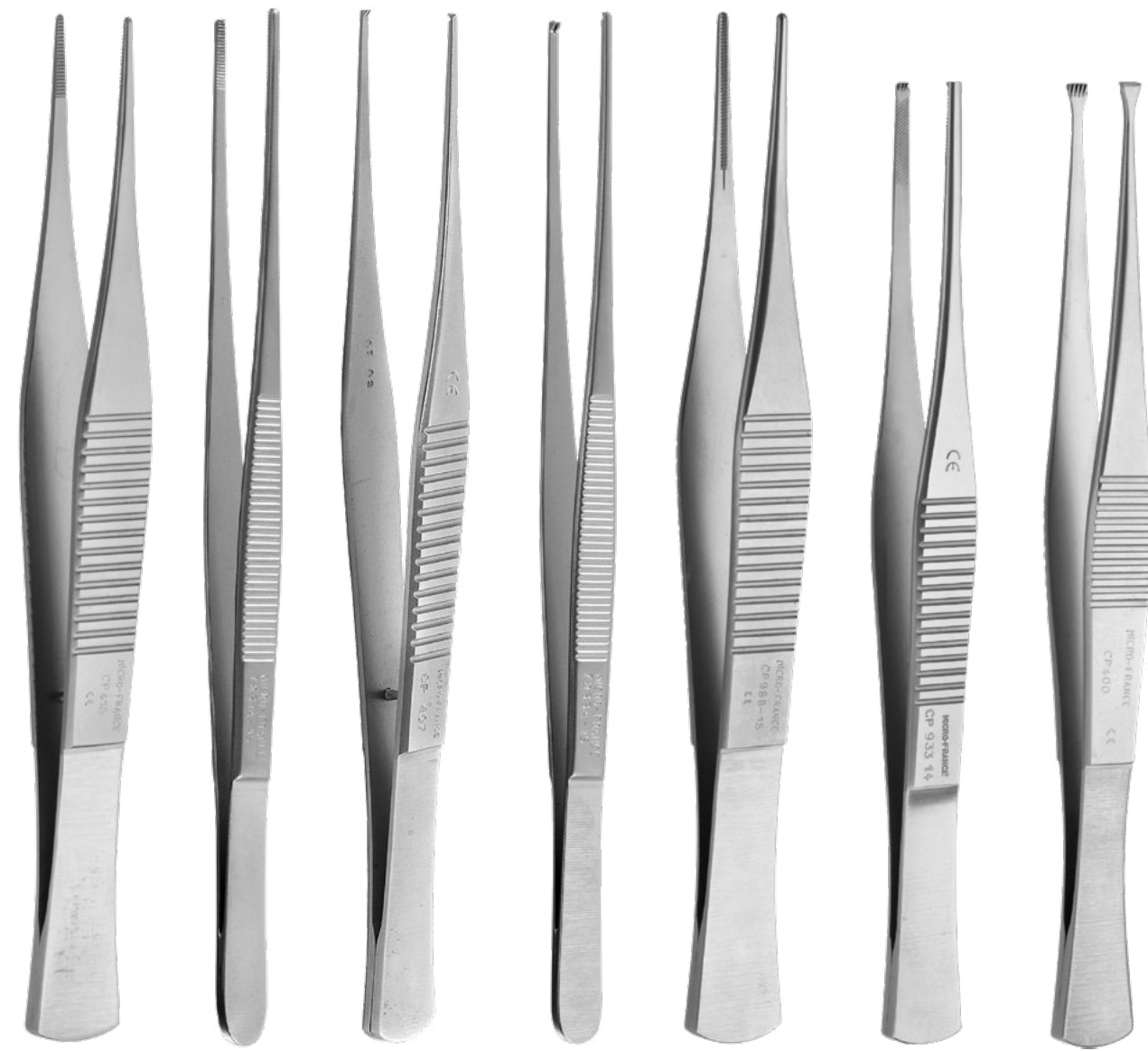

150mm

140mm

CP415	7831A-15	CP407	7833A-15	CP988-15	CP933-14	CP400
serrated jaws 1mm	serrated jaws 1.5mm	1x2 teeth jaws 1mm	1x2 teeth jaws 1.5mm	serrated jaws 1.5mm	3x4 teeth & serrated platform	5x5 teeth

Précelle



150mm

CP345

serrated
angled jaws

Barraya



160mm

CP933-16

3x4 teeth and
serrated platform

Claoué



160mm

CP401

5x6 teeth

Mac-Indoe



170mm

CP936

1x2 teeth and
serrated platform

Debakey

Barraya



1.5mm
7831A-18

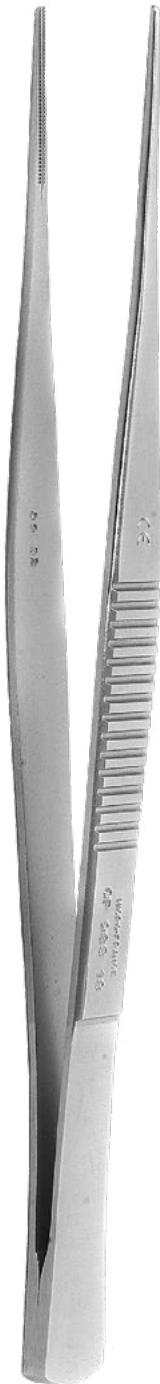

1.5mm
CP988-18



1mm
CP409
1x2



1.5mm
7833A-18
1x2



1.5mm
CP933-18
3x4 teeth and
serrated platform



6x6
CP400-2

Debakey



200mm	210mm
7832	7834
1mm serrated	1mm 1x2 teeth



2mm
7831A-20



1,5mm
CP988-20



2mm
7833A-20
1x2 teeth

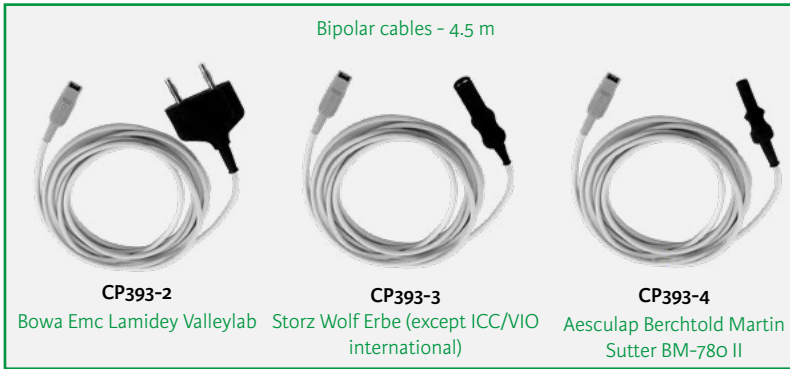

Magnan

Adson

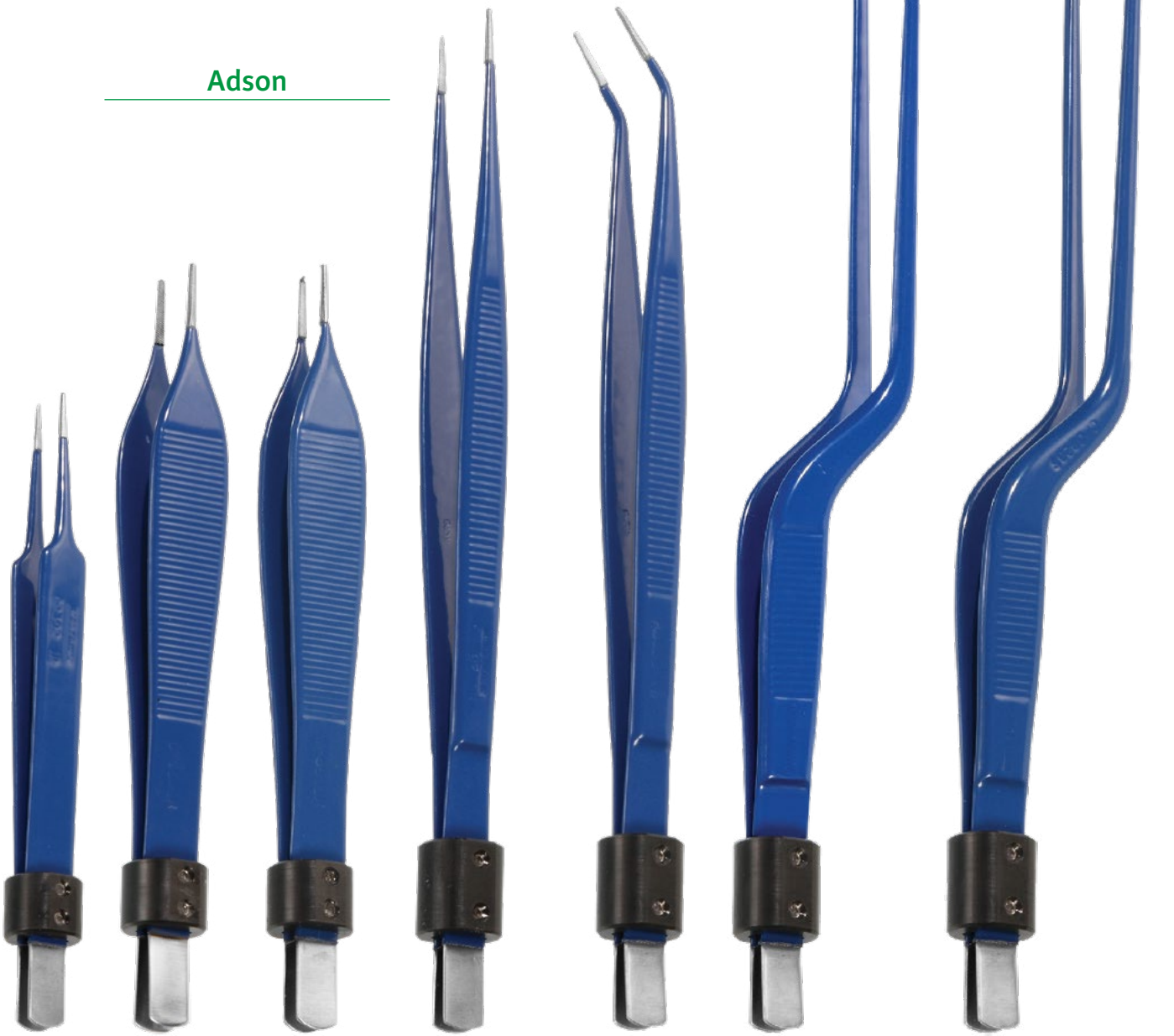

110mm		120mm			160mm		200mm	
CP392-1R	CP604BR	CP605BR	CP392-2R	CP392-8R	CP392BI	CP392BS		
smooth jaws 1x8mm	serrated jaws 1.5mm	1x2 teeth 1.5mm	smooth jaws 1x8mm	smooth jaws 1x8mm	smooth jaws 0.5x5mm	smooth jaws 0.5x5mm		



Bipolar cables - 4.5 m



CP393-2
Bowa Emc Lamidey Valleylab



CP393-3
Storz Wolf Erbe
(except ICC/VIO international)



CP393-4
Aesculap Berchtold Martin
Sutter BM-780 II

CP392-3R Straight smooth jaws 1x8mm	CP392-10R Angled tip smooth jaws 1x8mm	CP392-5R Bayonet smooth jaws 1x8mm	CP392-9R Bayonet Angled down jaws 1x8mm
---	--	--	---

Scale 2/3

Dousset



300mm

CEV392D30

Jaws 3mm

Belghiti



230mm

CEV392D20

Jaws 2mm



230mm

CEV392P20

Jaws 2mm

Soubrane



230mm

CEV392S20

Jaws 2mm

Gayet



240mm

CEV392G24

Jaws 5x15mm

Partenski



210mm

CEV392R15

Jaws 4x10mm

Bipolar cables - 4.5 m

		
CP393-2 Bowa Emc Lamidey Valleylab	CP393-3 Storz Wolf Erbe (except ICC/VIO international)	CP393-4 Aesculap Berchtold Martin Sutter BM-780 II

Scale 2/3

Working length - «L»

Chambon



290mm L 260mm
CP390L26
smooth jaws 1x8mm



CP390-3
smooth jaws 1x8mm



230mm L 200mm
CP390-5
angled jaws 1x8mm



CP390-7
smooth jaws 1x8mm

Monopolar cables 3.5m



CP391E
Erbe ACC ICC/VIO
Storz Wolf



CP391M
Aesculap Berchtold Martin
Erbe T Serie Lamidey
Sutter BM-780 II



CP391V
Bowa Bovie Conmed Valleylab



Adson



110mm

CP390-1

smooth jaws 1x8mm



120mm

CP604M

serrated jaws 1.5mm



CP605M

1x2 teeth 1.5mm



160mm

CP390-2

smooth jaws 1x8mm



CP390-8

1x2 teeth 1x8mm

Halsey

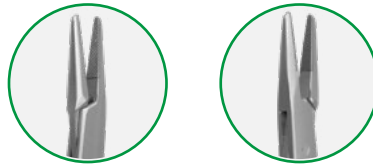

130mm

703T	704T
serrated jaws	smooth jaws



703T

Crile-Wood Mayo-Hégar

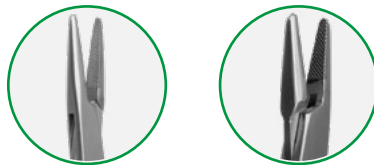

150mm

702T	714T
------	------



702T

Becker

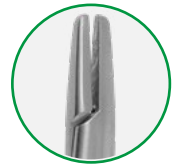

130mm

CP1107
diamond jaws

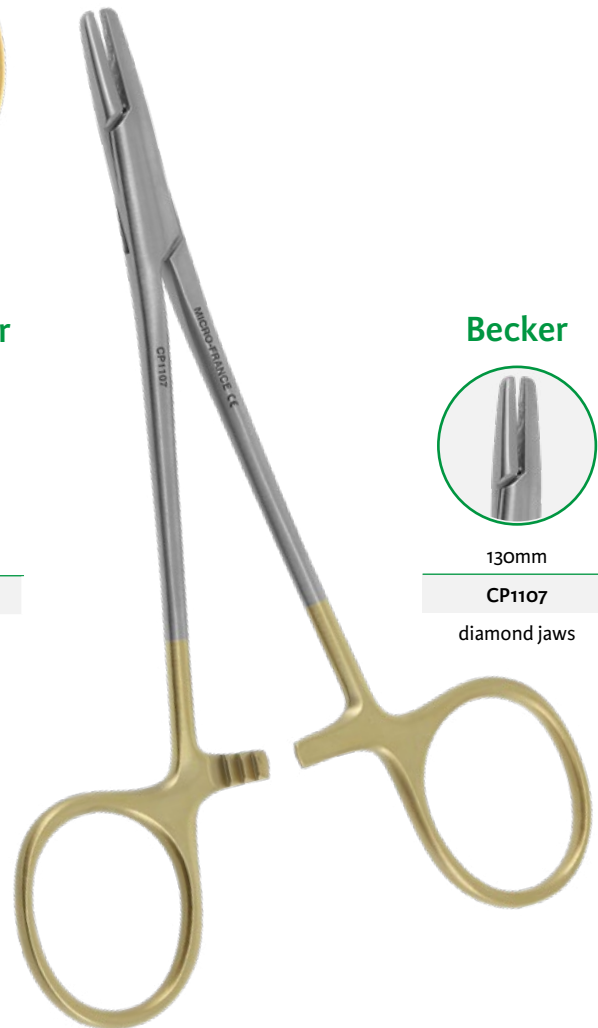

Scale 2/3

Crile-Wood

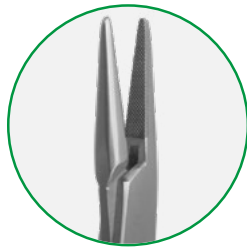

200mm

720T



Crile-Wood

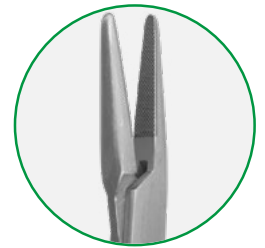

180mm

701T



Stratte



210mm

7945T



Halsted

120mm - with teeth

P761-7	P761-8
--------	--------

Straight	Curved
----------	--------



P761-7

Leriche

140mm - without teeth

7867-1	7867-2
--------	--------

Straight	Curved
----------	--------

140mm - with teeth

7867-3	7867-4
--------	--------

Straight	Curved
----------	--------



7867-1

Kelly

without teeth

140mm	160mm
P762-2	P762-4
Curved	Curved



P762-2

Kocher

140mm	160mm	180mm
Straight without teeth		
P764-1	P764-5	-
Straight with teeth		
P764-3	P764-7	P764-11

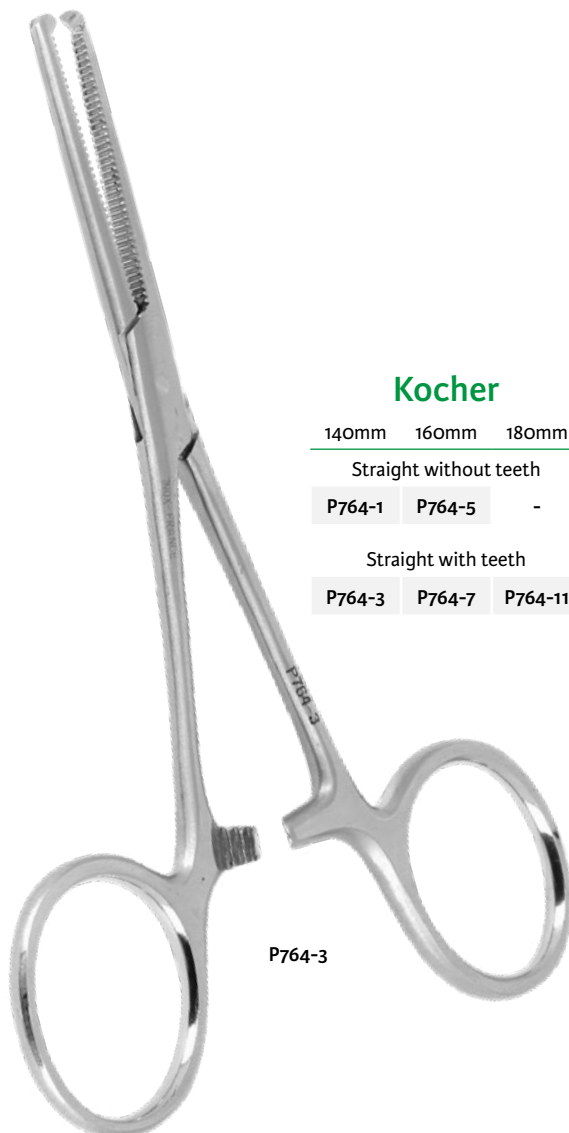

P764-3



Martel

130mm

P763

Forceps with teeth
'T' tip



Terrier

130mm

P769

Haemostatic forceps
serrated jaws



Péan

140mm 160mm

P765-14

P765-16

Haemostatic forceps
serrated jaws

P765-14

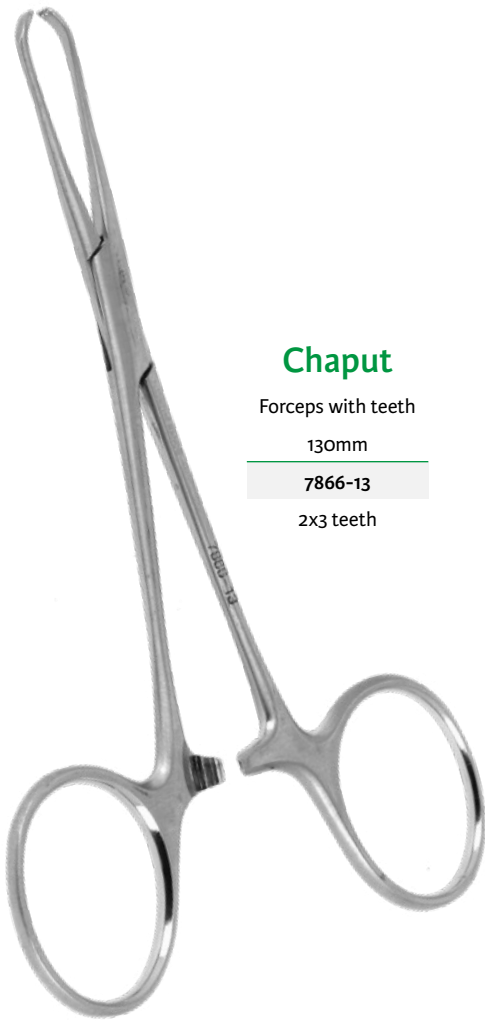

Chaput

Forceps with teeth

130mm

7866-13

2x3 teeth

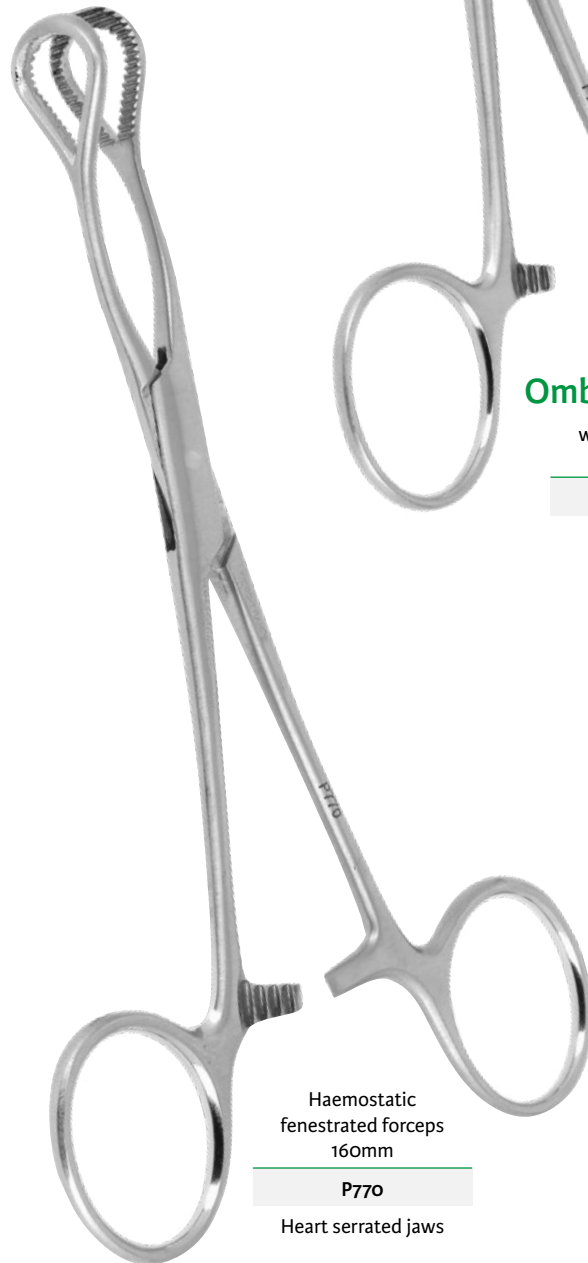

Haemostatic
fenestrated forceps
160mm

P770

Heart serrated jaws



Ombredanne

with teeth
130mm

P771

Scale 1/4

Blunt eyes suction tube

	2mm	2.5mm	3mm	3.5mm	4mm	
L 450mm	MCL920L45	MCL925L45	MCL930L45	MCL935L45	MCL940L45	MCL940L45
L 550mm	MCL920L55	MCL925L55	MCL930L55	MCL935L55	MCL940L55	

Forceps

Forceps	Crocodile forceps	Cup forceps Ø 4mm	Cup forceps up opening 3.5x10mm	Cup forceps upward Ø 4mm	
L 400mm	7844T3L40	7844T5L40	7844T6L40	7844T7L40	7844T5L40
L 450mm	7844T3L45	7844T5L45	7844T6L45	7844T7L45	
L 500mm	7844T3L50	7844T5L50	7844T6L50	7844T7L50	
L 550mm	7844T3L55	7844T5L55	7844T6L55	7844T7L55	
L 600mm	7844T3L60	7844T5L60	7844T6L60	7844T7L60	

Esophagoscope

MCL320 Esophagoscope without handle - fiber
12x16mm

Handle: MCL112H
Fiber: MCL320F
Length: L 300mm

MCL330 Esophagoscope without handle - fiber
12x16mm

Handle: MCL112H
Fiber: MCL330F
Length: L 500mm

Sterilization case
7874MF-61
640x189x95mm - L 610x180x80mm
Scale 1/3

Scale 1/4

Working length - «L»



Blunt eyes suction tube

	2mm	2.5mm	3mm	3.5mm	4mm	
L 250mm	MCL920L25	MCL925L25	MCL930L25	MCL935L25	MCL940L25	MCL930L25
L 350mm	MCL920L35	MCL925L35	MCL930L35	MCL935L35	MCL940L35	

Forceps

Forceps	Crocodile forceps	Cup forceps Ø 4mm	Cup forceps up opening 3.5x10mm	Cup forceps upward Ø 4mm	
L 200mm	7844T3L20	7844T5L20	7844T6L20	7844T74L20	7844T5L25
L 250mm	7844T3L25	7844T5L25	7844T6L25	7844T74L25	
L 300mm	7844T3L30	7844T5L30	7844T6L30	7844T74L30	
L 350mm	7844T3L35	7844T5L35	7844T6L35	7844T74L35	

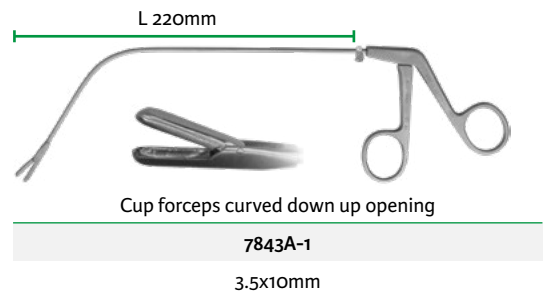
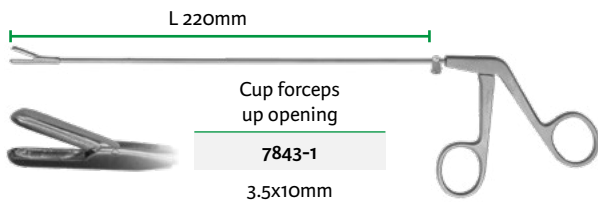

Hypopharyngoscope

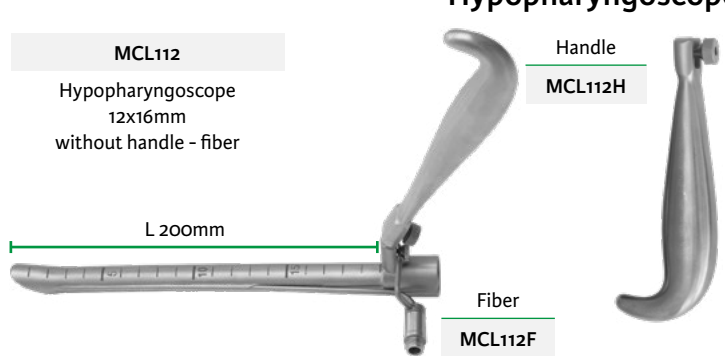
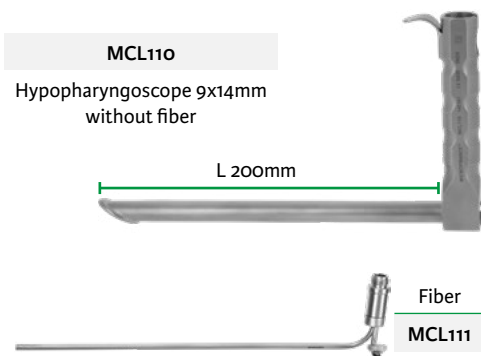

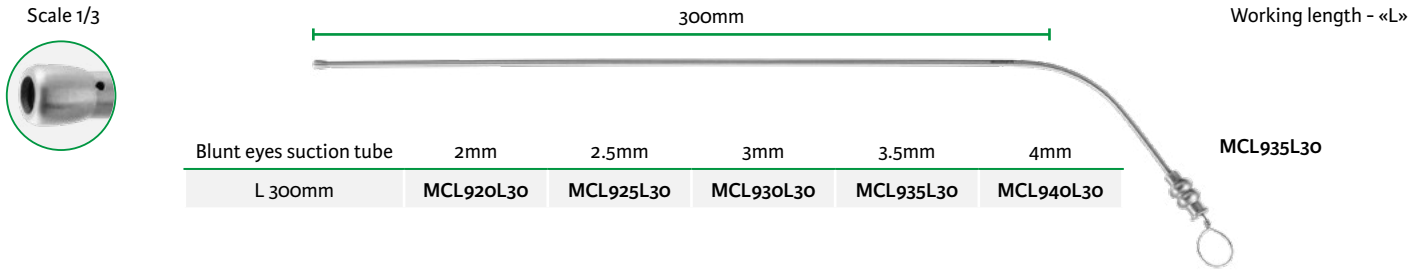

Lacau diverticuloscope

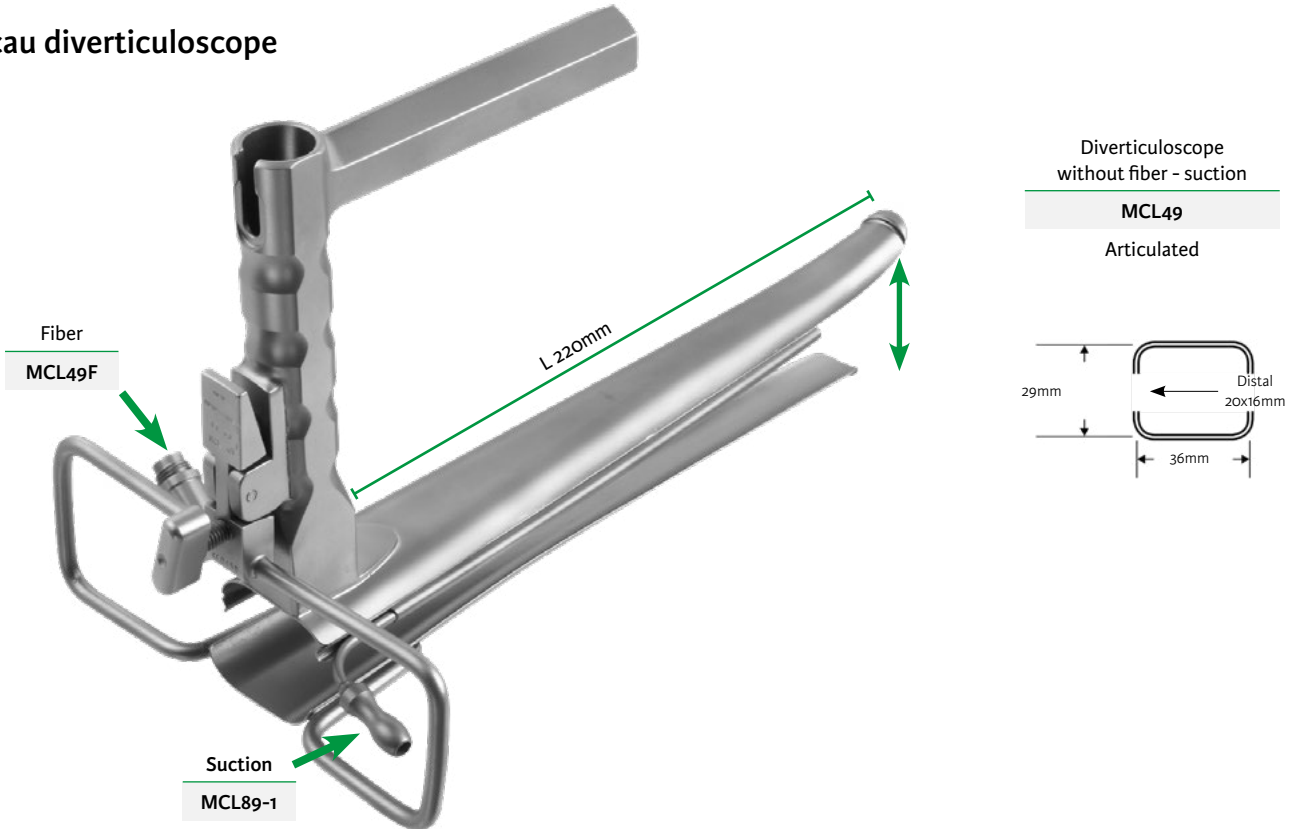

Reyt diverticuloscope

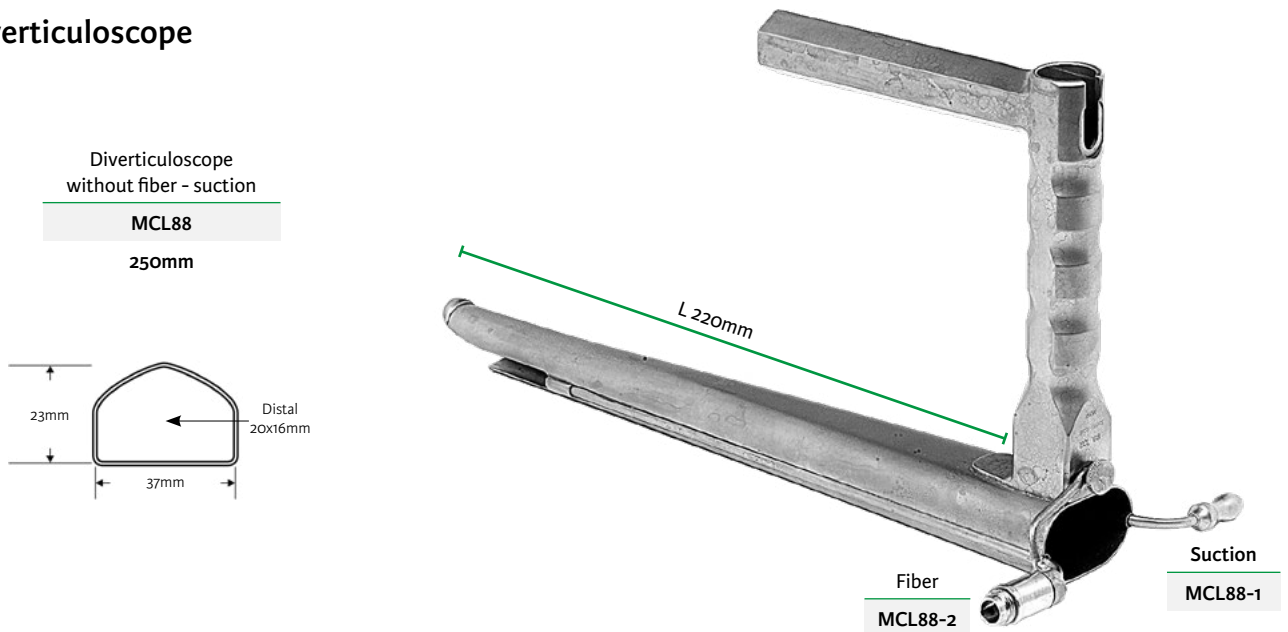

Picture for information, without scale

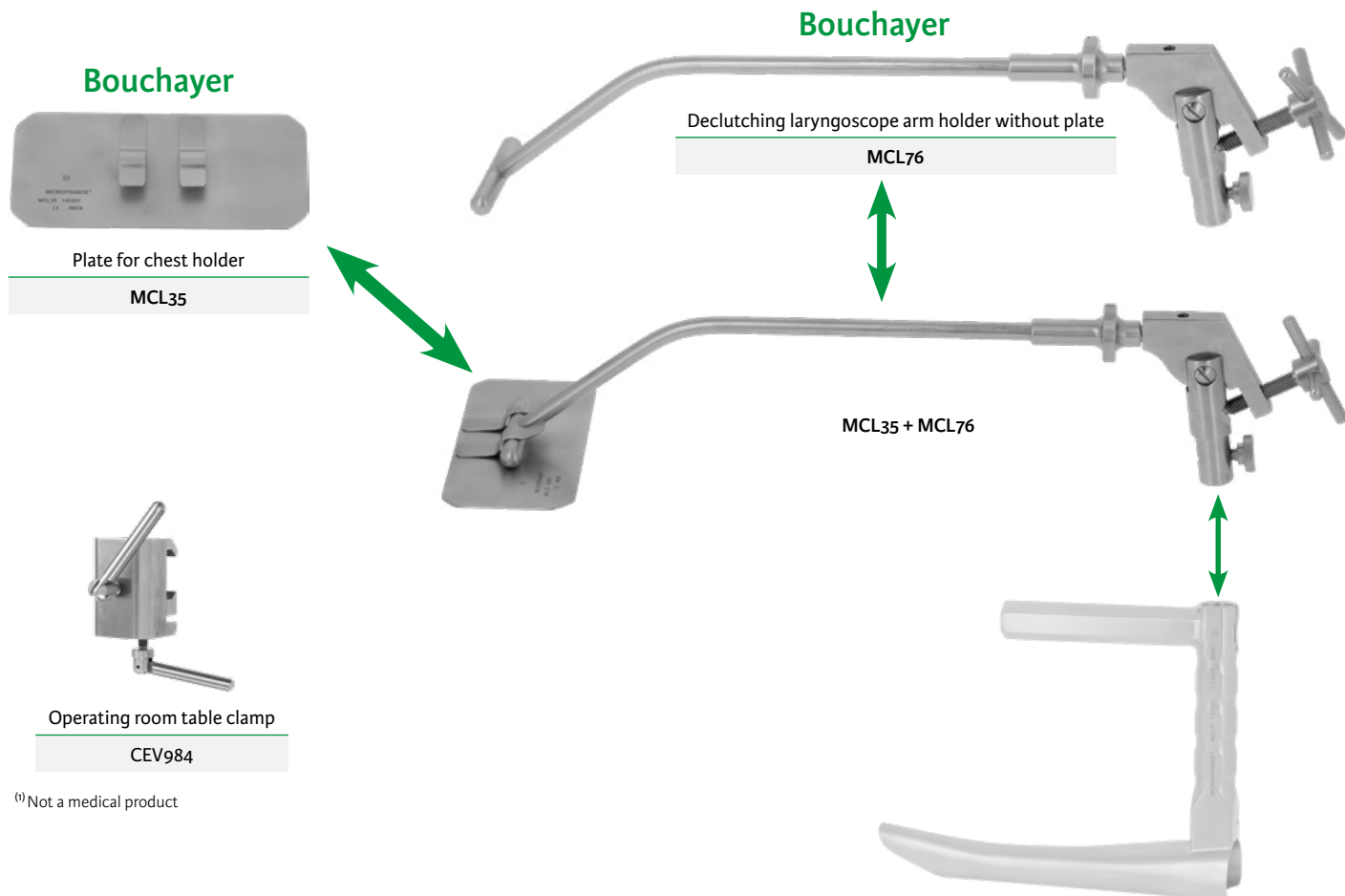

^(f) Not a medical product

Cold light



Adapters	generator side	instrument side
Wolf	MCL170 ^{(D)(f)*}	MCL171 ^{(D)(f)*}
Storz	MCL173 ^{(D)(f)*}	MCL174 ^{(D)(f)*}
Olympus	MCL197 ^{(D)(f)*}	

^(D) Distributed by Integra MicroFrance SAS (France) - For corresponding manufacturer part numbers, see table in annex
*Please check with your sales representative availability of this product in your country

Scale 1/3

Working length - «L»

Lescanne

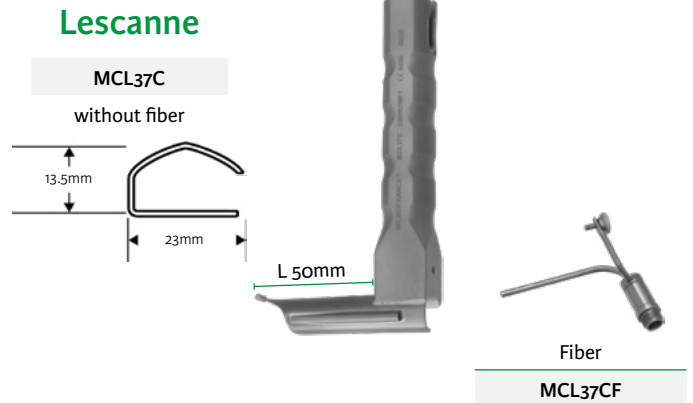
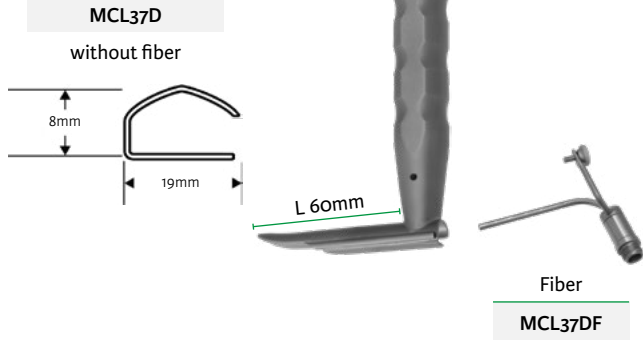

Garabédian

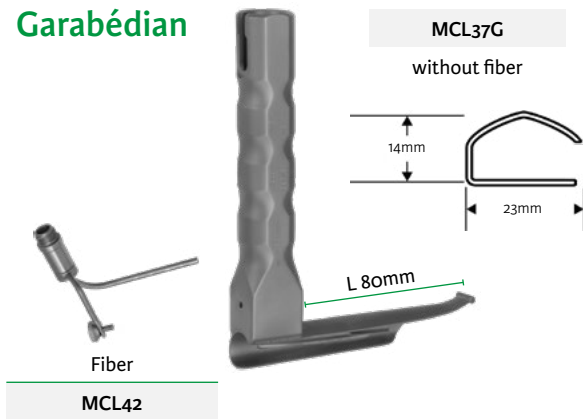

Garcin

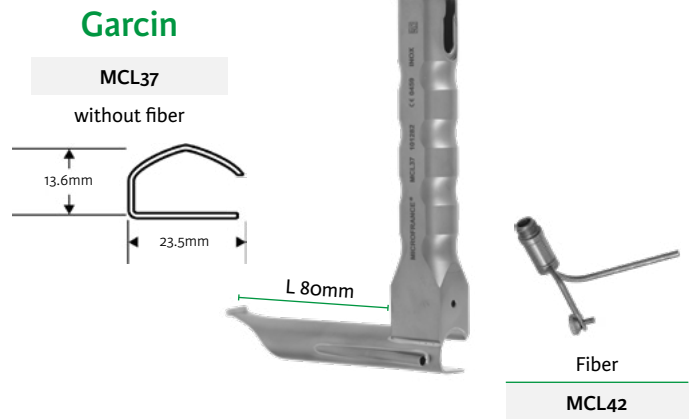

Legent

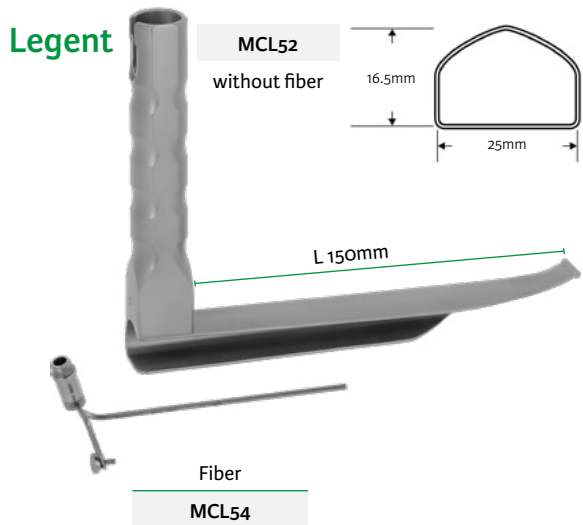

Legent

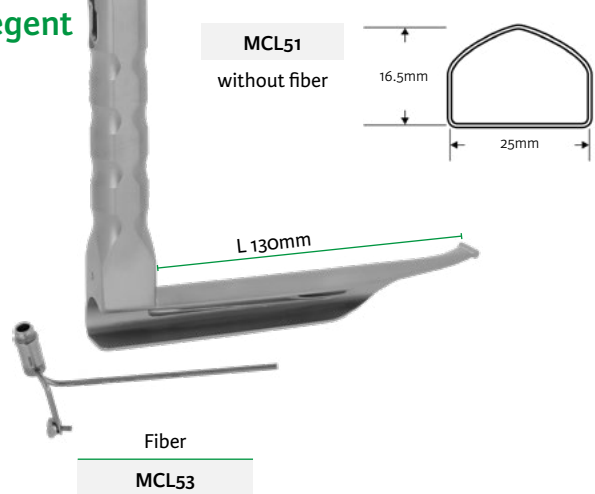

Scale 1/3

Working length - «L»

Bouchayer

MCL79
without fiber

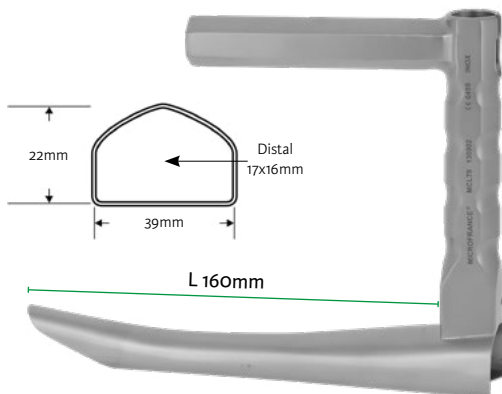

Bouchayer

MCL77
without fiber

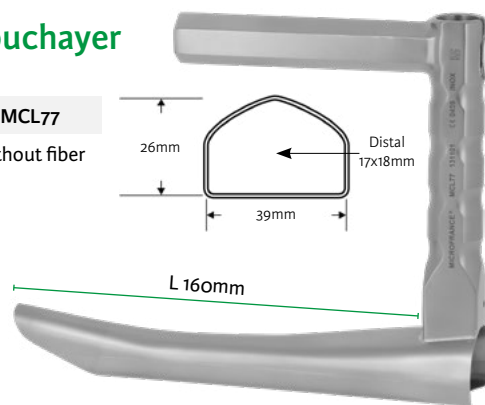

Fiber
MCL78

Pignat

MCL64
without fiber
small size

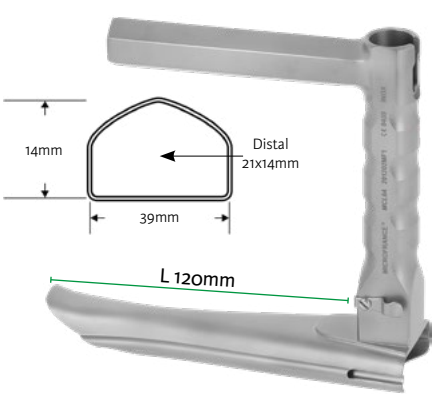

Pignat

MCL63
without fiber
large size

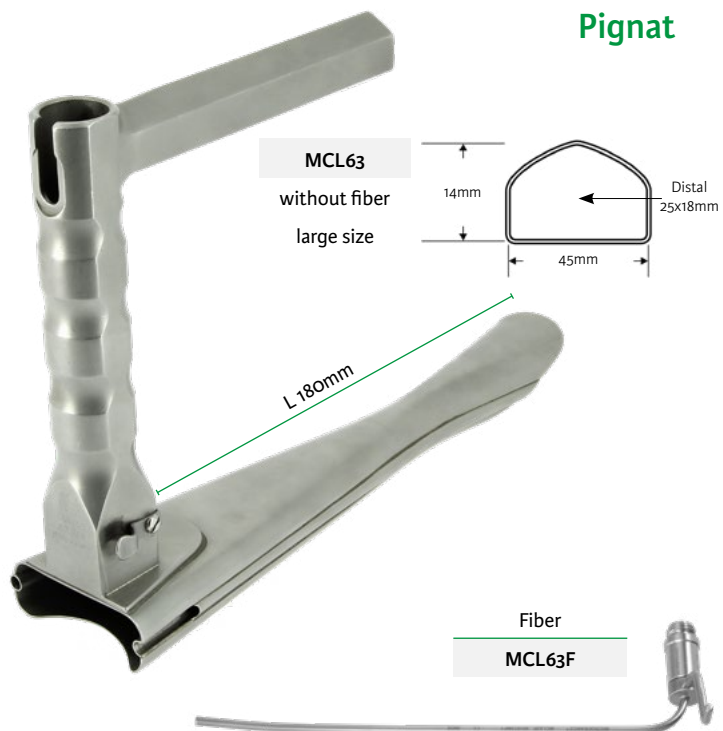

Fiber
MCL64F

Fiber
MCL63F

Scale 1/3

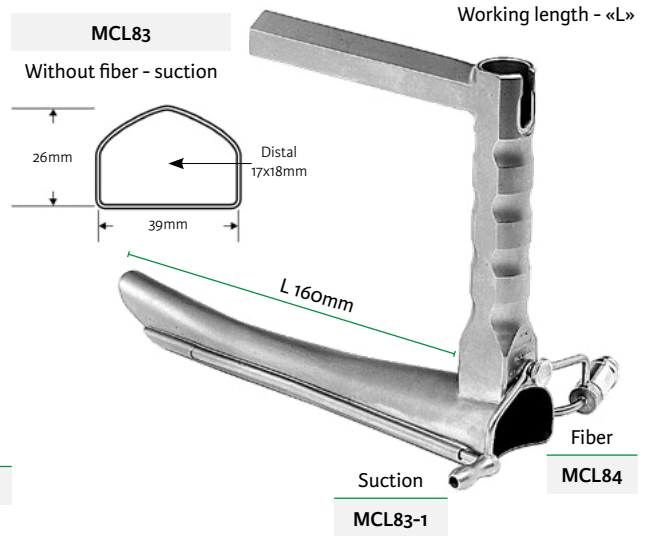
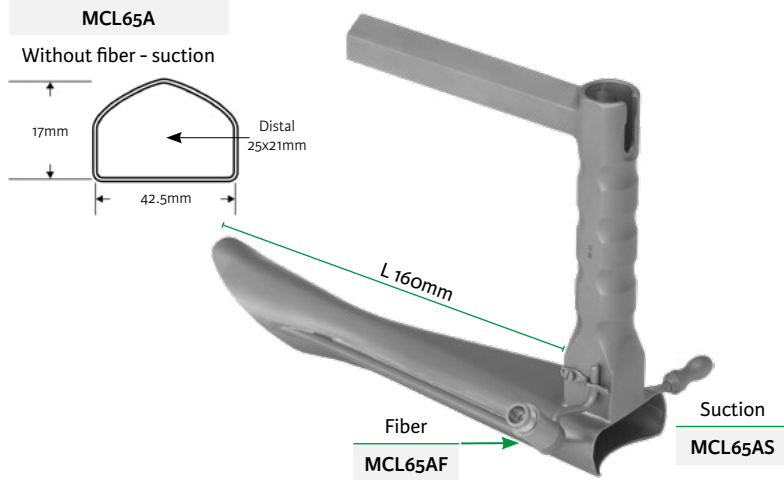

Abitbol

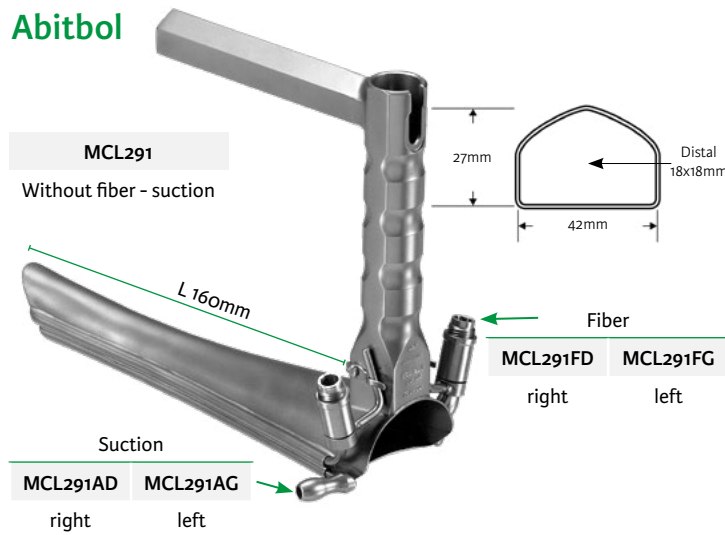

Brasnu

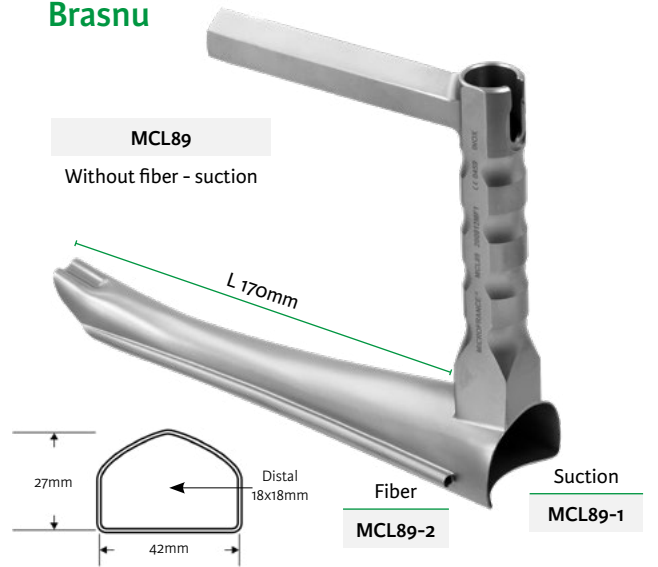

Abitbol

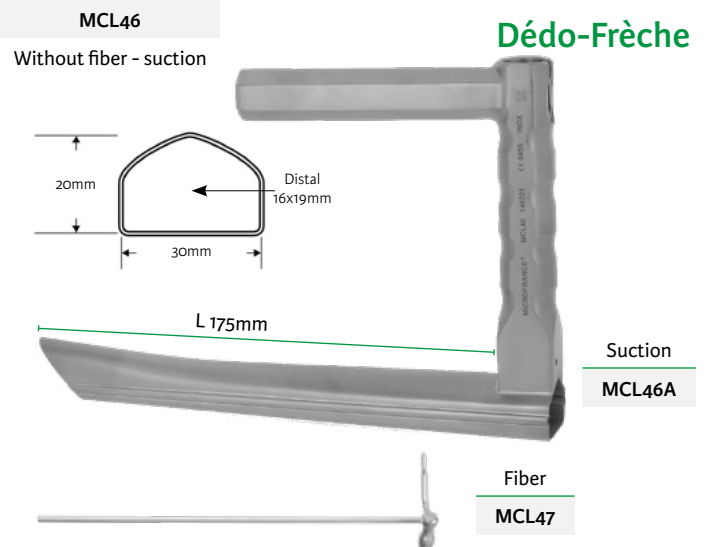
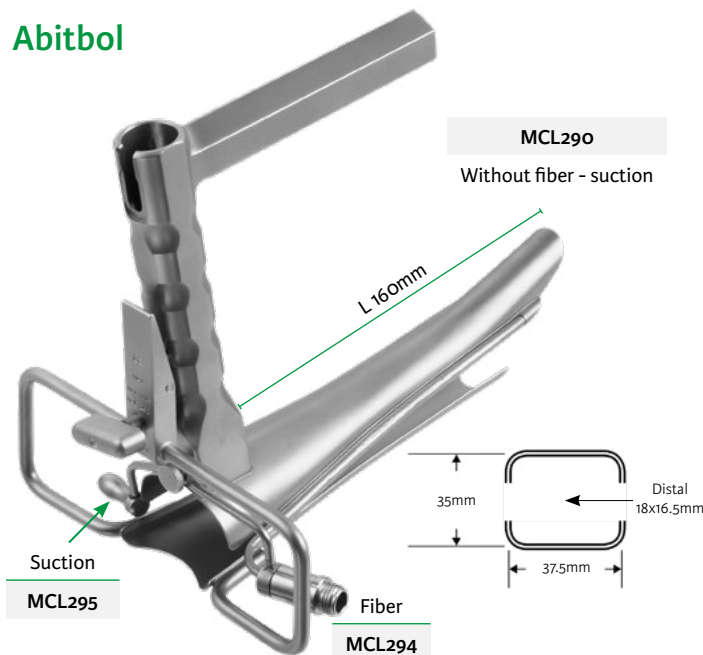

Scale 1/3

Sataloff

Working length - «L»

MCL120

Pediatric size
With fiber and suction

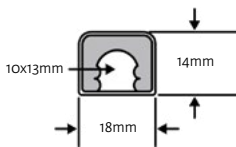

MCL121

Medium male size
With fiber and suction

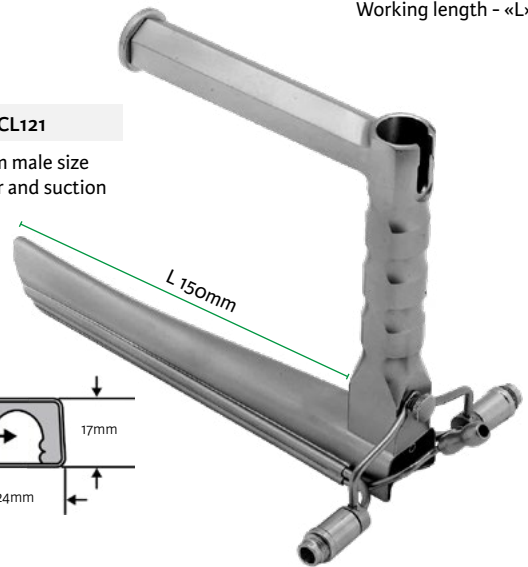
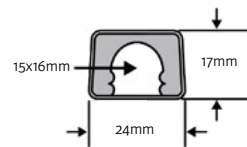

MCL122

Adult size
With fiber and suction

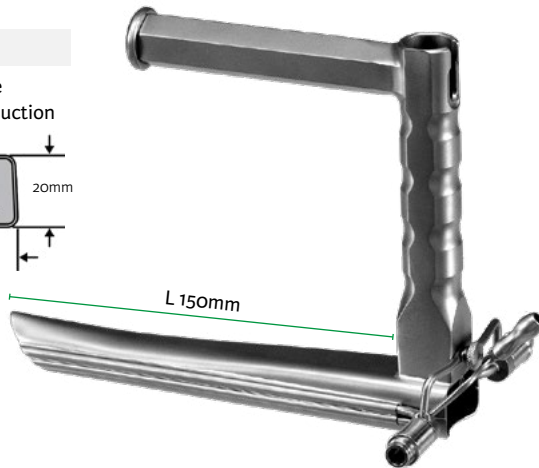
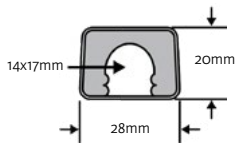

MCL123

Medium female size
With fiber and suction

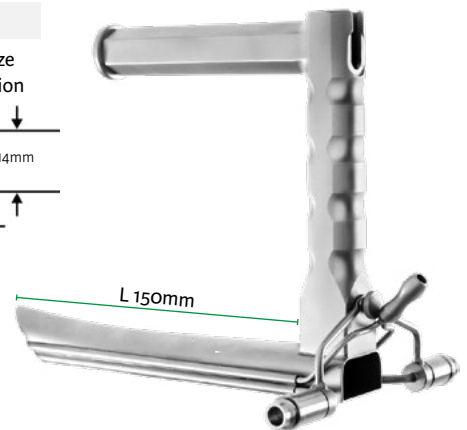
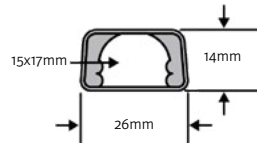

MCL124

«Vallecula»
With fiber and suction

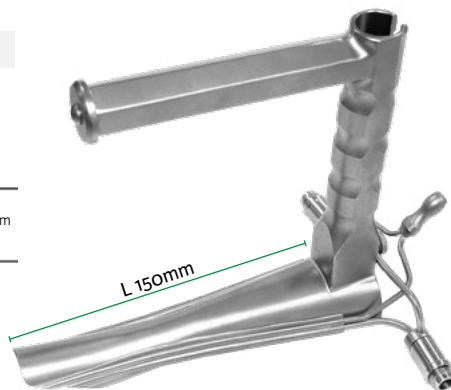
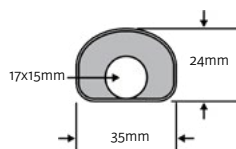

MCL125

With fiber and suction

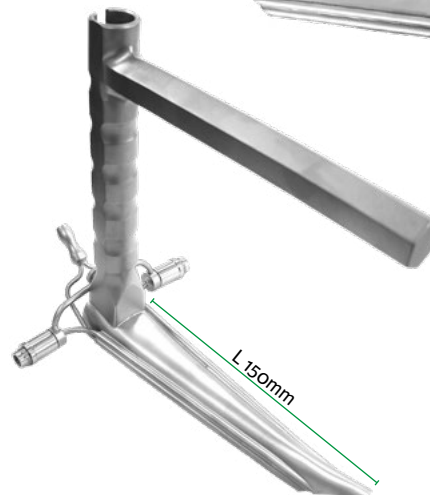
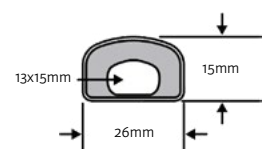

Complete laryngoscope	Right light fiber	Left light fiber	Dual suction tube
MCL120	MCLS120-2	MCLS120-1	MCLS120-3
MCL121	MCLS121-2	MCLS121-1	MCLS121-3
MCL122	MCLS122-2	MCLS122-1	MCLS122-3
MCL123	MCLS123-2	MCLS123-1	MCLS1233
MCL124	MCL124FR	MCL124FL	MCL124ST
MCL125	MCL125FR	MCL125FL	MCL125ST

Suction tube

Bouchayer

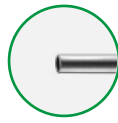

MCL10
Ø 2.5mm

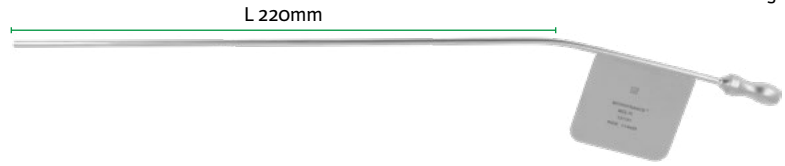

Working length - «L»

Scale 1/3

Blunt eyes suction tube

Brasnu

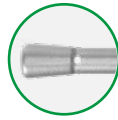

MCL100
Ø 2.5mm

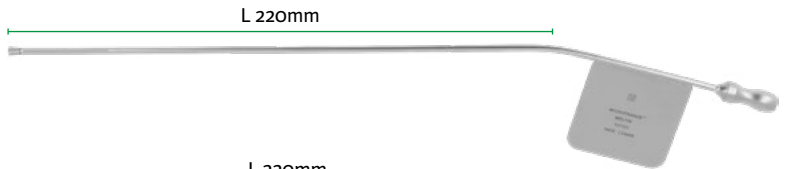

Garabédian



MCL100T20 MCL100T15
Ø 2mm Ø 1.5mm

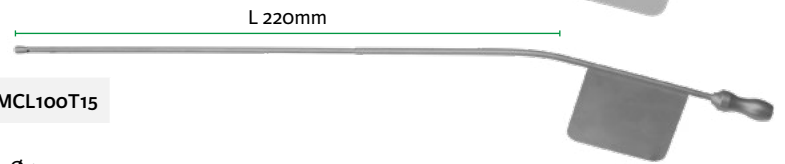

Insulated suction tube

Abitbol

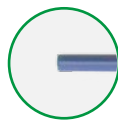

MCL210
Ø 2.5mm

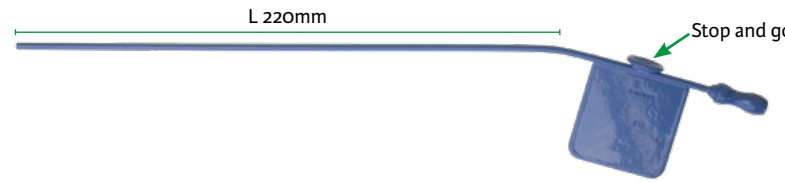

Dual suction tube

Huttenbrink

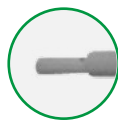

MCL103
Ø 2.5mm

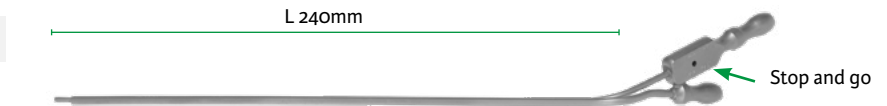

French velvet eye suction tube

Sataloff

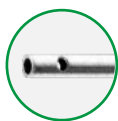

Micro suction tube
MCL-S16



300mm - Ø 1mm
Micro suction tube
with retractor below
MCL-S17



Micro suction tube with
retractor above
MCL-S17-1

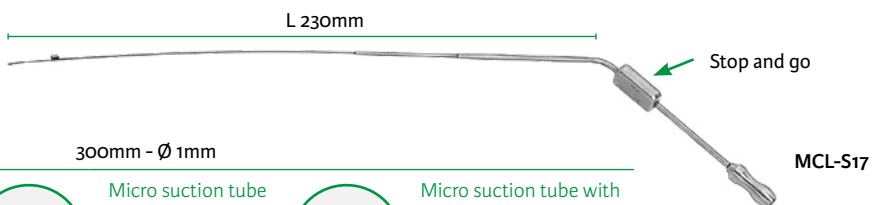

MCL-S17

Working length - «L»

Scale 1/3



MCL18 curved right	MCL15 curved left	MCL25 straight
------------------------------	-----------------------------	--------------------------



Alligator forceps

Bouchayer

MCL18

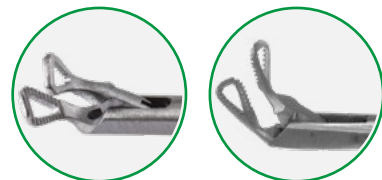

MCL19 left	MCL19BIS right
----------------------	--------------------------



Heart-shaped forceps 45°

Bouchayer

MCL19

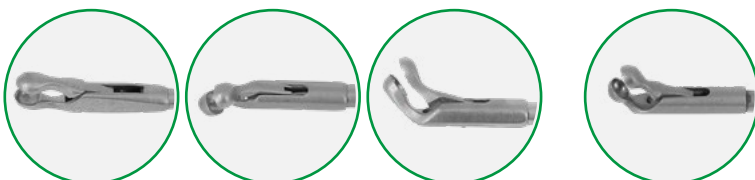

MCL12 straight	MCL29 curved left 45°	MCL30 curved right 45°	MCL33 upward
--------------------------	------------------------------------	-------------------------------------	------------------------

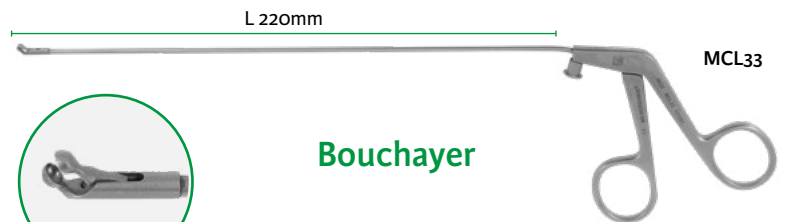

Cup forceps Ø 2mm

Bouchayer

MCL33



MCL67 upward	MCL68 curved left	MCL69 curved right
------------------------	-----------------------------	------------------------------

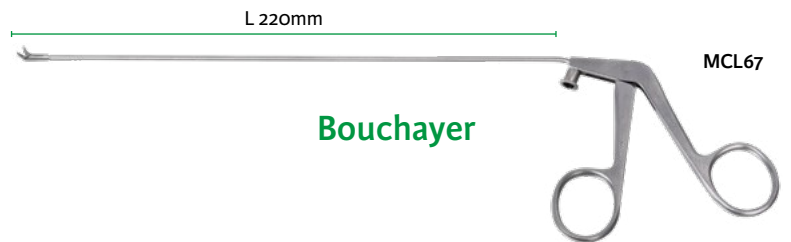

Oval cup forceps

Bouchayer

MCL67

Scale 1/2

Micro scissors

Bouchayer

L 220mm



MCL11
straight



MCL31
angled up - 45°



MCL16
right curved



MCL17
left curved



MCL11

Lancet knife, elevator

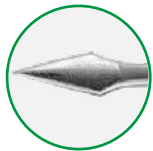

Lancet knife

MCL57



Angled elevator 90°

MCL81BL
left



MCL81BR
right



Elevator

MCL56BL
curved left



MCL56BR
curved right

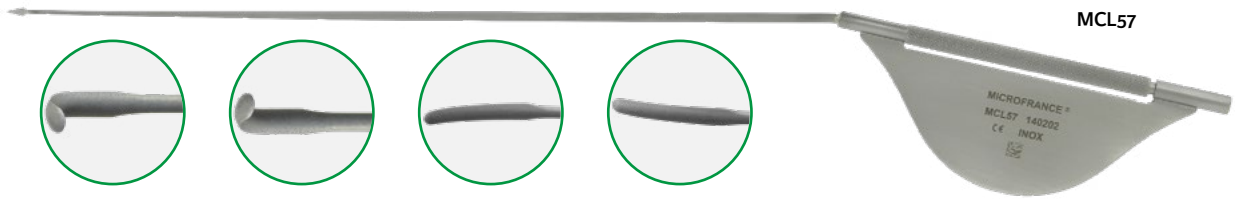

MCL57

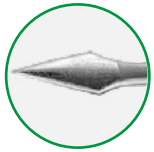

Lancet knife handle and 3 blades

MCL93

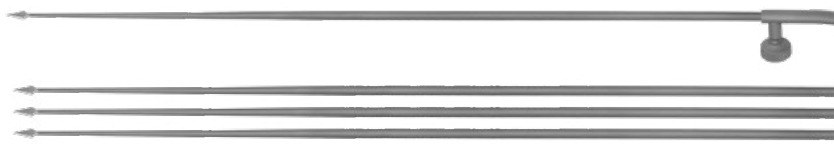

knife blades (pk 3) for MCL93

MCL93-2



MCL93

Micro needle-holder



MCL94
straight serrated jaws
1.5x5mm

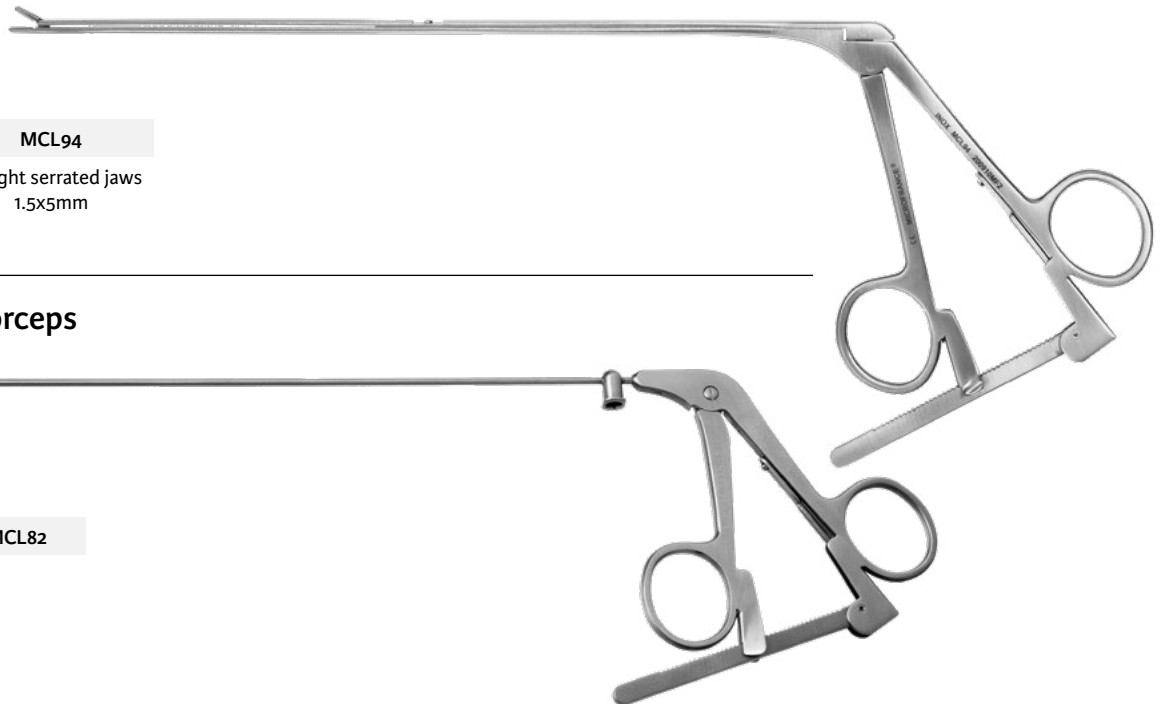

Micro retractor forceps



MCL82



Scale 1/2

Elevator

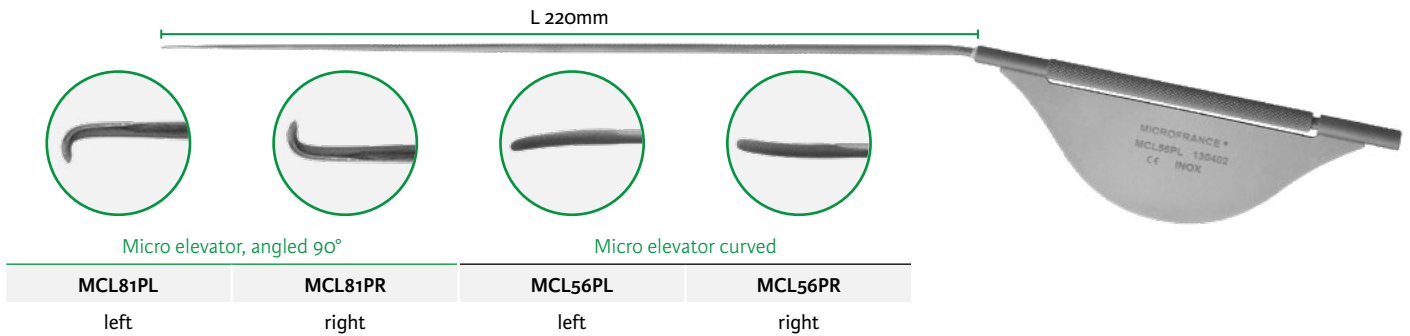

Stylet handle and needle-holder insert

Scale 1/3

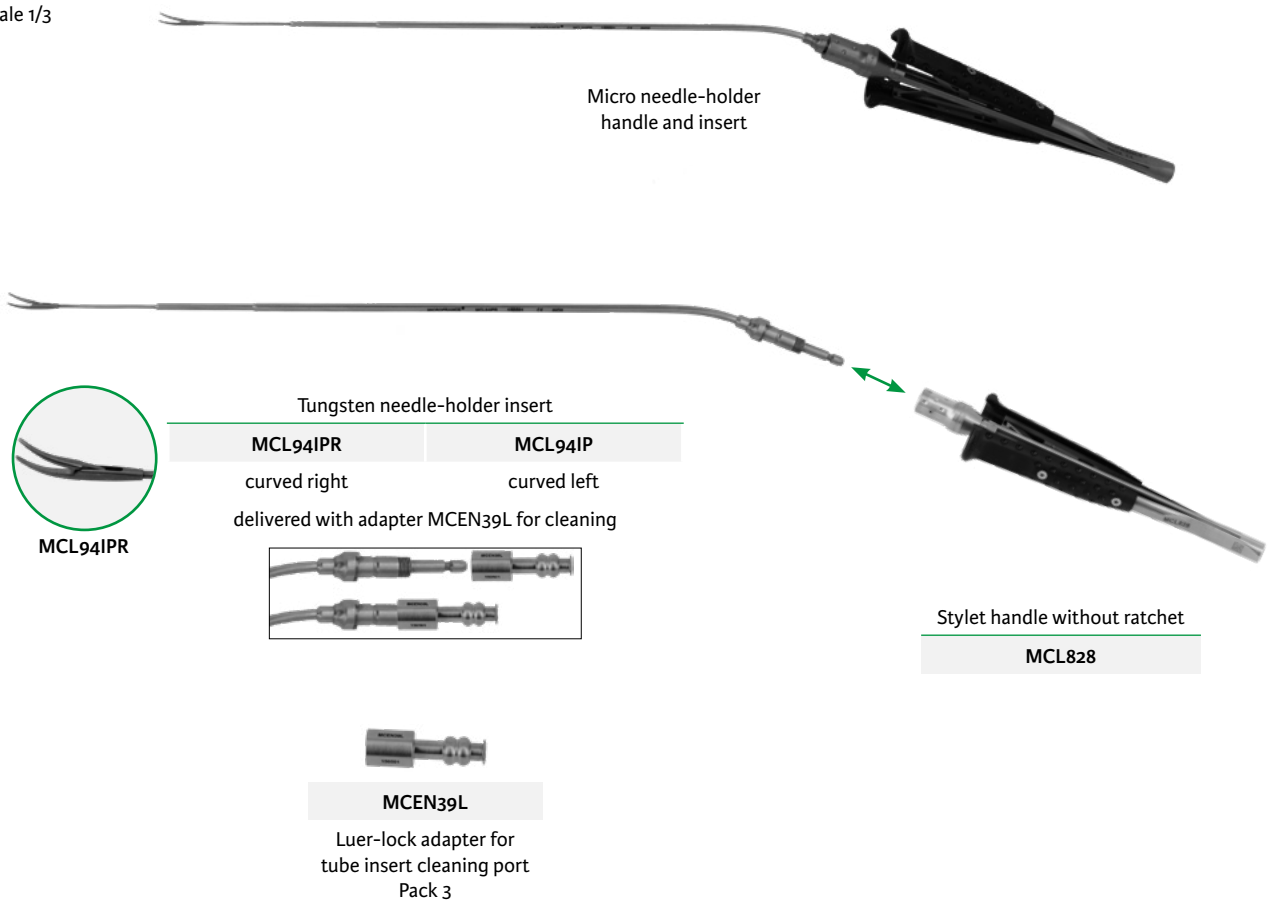

Scale 1/3
Working length - «L»

Insulated suction tube with finger control

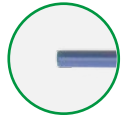

MCL210
Ø 2.5mm

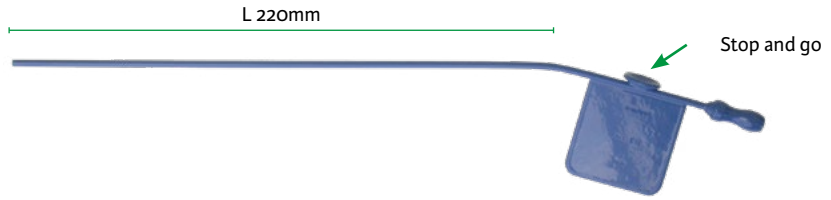

Monopolar fenestrated forceps



MCL205
3x9mm jaws



Heart-shaped forceps, monopolar



MCL219
right curved



MCL219-1
left curved

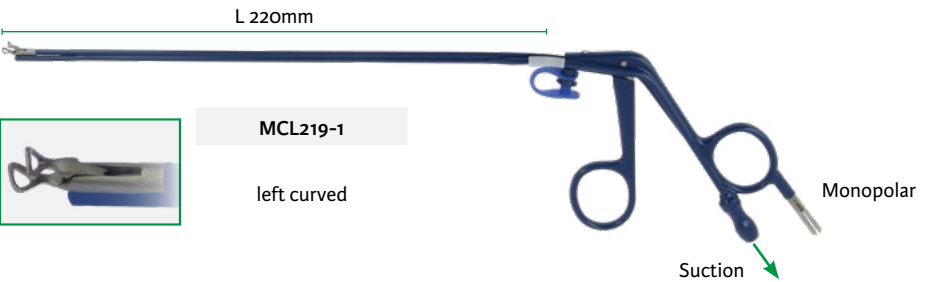

Alligator forceps, monopolar



MCL241
right curved



MCL241-1
left curved

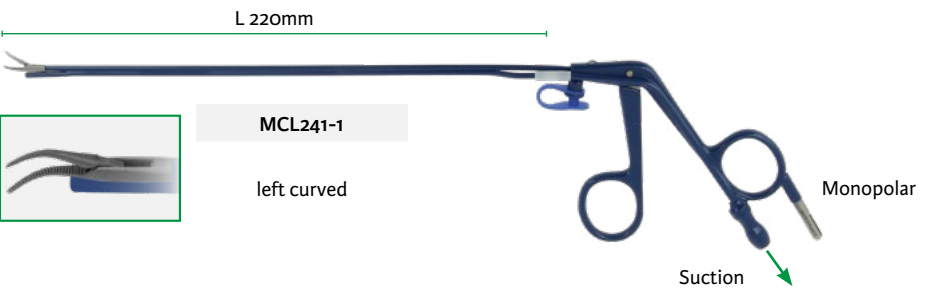

Monopolar cables - 3.5 m



CP391E

Erbe ACC ICC/VIO Storz Wolf



CP391M

Aesculap Berchtold Lamidey Martin Erbe T Serie Sutter BM-780 II



CP391V

Bowa Bovie Conmed Valleylab

Scale 1/2 Working length - «L»

Knife blade sterile, Single use, Pack 25
Scale 2/3

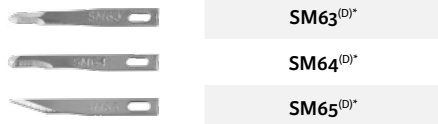

Laryngeal diastema - pediatrics

CP821E

Scalpel handle 170mm

Scalpel handle, knife blade

Garabédian

Scale 1/3

L 180mm

Micro pediatric needle-holder
handle and insert



Tungsten needle-holder insert



MCL94IG

delivered with adapter
MCEN39L for cleaning



MCEN39L

Luer-lock adapter for
tube insert cleaning port
Pack 3

Stylet handle with ratchet

MCL828C

Needle-holder

Garabédian

Scale 1/2

L 230mm

Needle-holder, tungsten jaws



MCL94G

1-piece

Cleaning
instrument

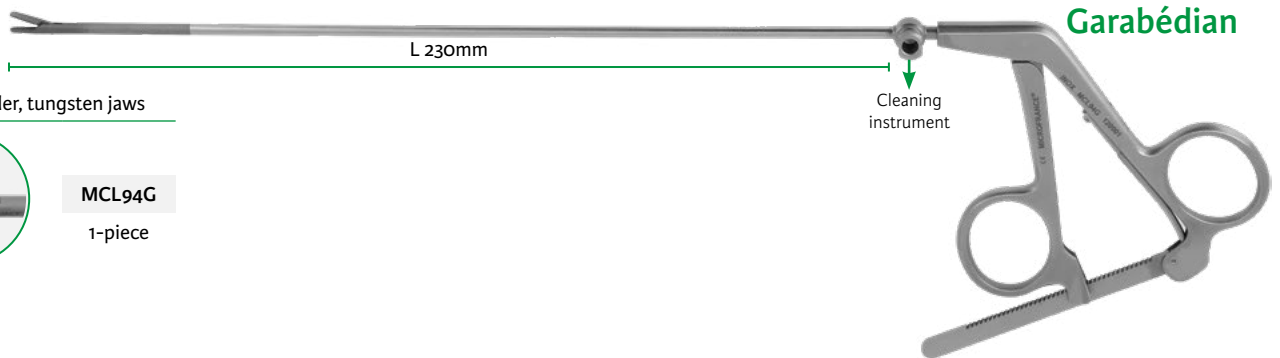

Garabédian

Oval knife, hook, retractor

Scale 1/2

L 220mm



MCL4

oval knife 3x4mm



MCL5

oval knife 45° 2mm



MCL7

blunt hook



MCL48

blunt retractor 7mm



Micro sickle knife

Scale 1/2

Micro sickle knife curved 10mm

L 220mm



MCL1BIS

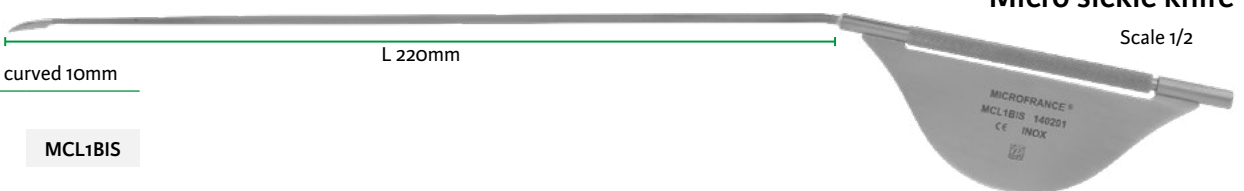

^(D) Distributed by Integra MicroFrance SAS (France) - For corresponding manufacturer part numbers, see table in annex
*Please check with your sales representative availability of this product in your country

Parsons

Laryngeal sprinkler

L 200mm

Scale 1/2
Working length - «L»

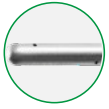

MCL98

Ø 1,5mm



Bouchayer

Bayonet injection needle

L 210mm



MCL58

Ø 0,5mm



Woo

Scissors, 5mm blades

L 200mm



MCLW10

straight

MCLW11

up 45°

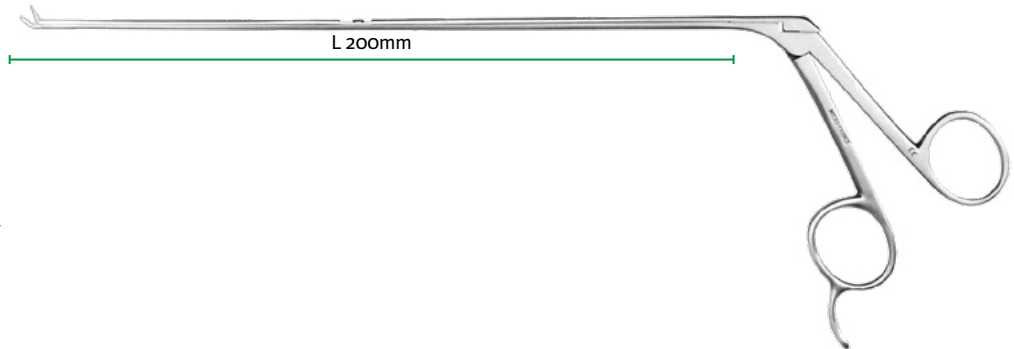

3734115

knife

L 250mm



Lowinger

Double probe

MCL101

Ø 2,5mm / 1mm
280mm

MCL102

Ø 2mm / 1mm
260mm

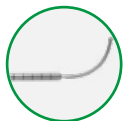

Scale 1/3

Working length - «L»

Monopolar instruments

Frèche

Electrode pick bayonet

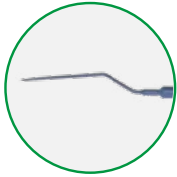

MCL59



Suction tube with finger control

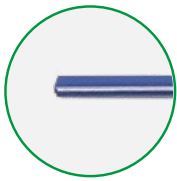

MCL62

Ø 2.5mm

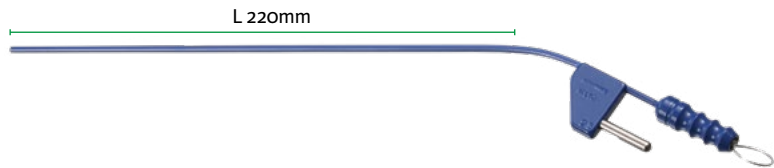

Monopolar cables - 3.5 m



CP391E

Erbe ACC ICC/VIO Storz Wolf



CP391M

Aesculap Berchtold Lamidey Martin Erbe T Serie Sutter BM-780 II



CP391V

Bowa Bovie Conmed Valleylab

Bipolar forceps

Micro forceps, straight jaws



MCL34



Delivered with box and tray

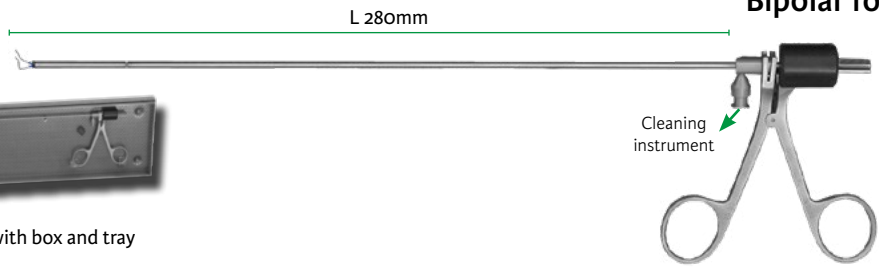

Peretti

Micro forceps, angled jaws



MCL340

Jaws 45° - 2mm

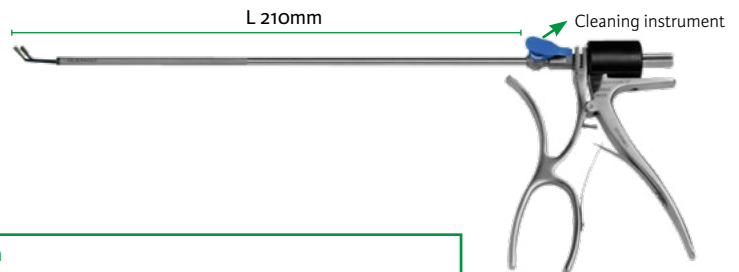

Bipolar cables - 4.5 m



CP393-2

Bowa Emc Lamidey Valleylab



CP393-3

Storz Wolf Erbe (except ICC/VIO international)



CP393-4

Aesculap Berchtold Martin Sutter BM-780 II

Injector, injection needles

Bouchayer

Injection needle
bayonet tip Ø 1mm



MCL55-1



MCL55-2

right



MCL55-3

left

Injection needle, straight
malleable Ø 0.5mm



MCL55U

Pk 6 - Single use
non sterile

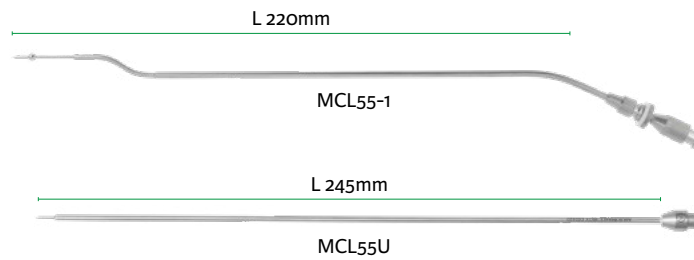

Scale 1/3

Working length - «L»

Injector

MCL55

with needle MCL55-1

MCL55B

with adapter MCL55R

Luer-lock adapter



MCL55R

Scale 1/1

Transcervical laryngeal injection

Casiano

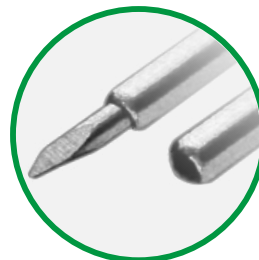

Handle for injection needle

MCL55T4

Trocar obturator

MCL55T6

Injection needle
Ø 0.8mm L 40mm - Pack 6

MCL55T5

non sterile

Scale 1/3

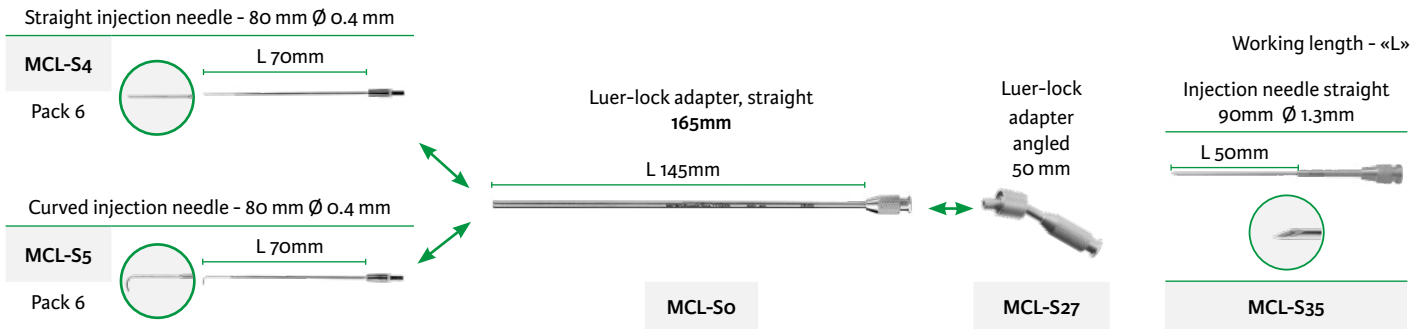

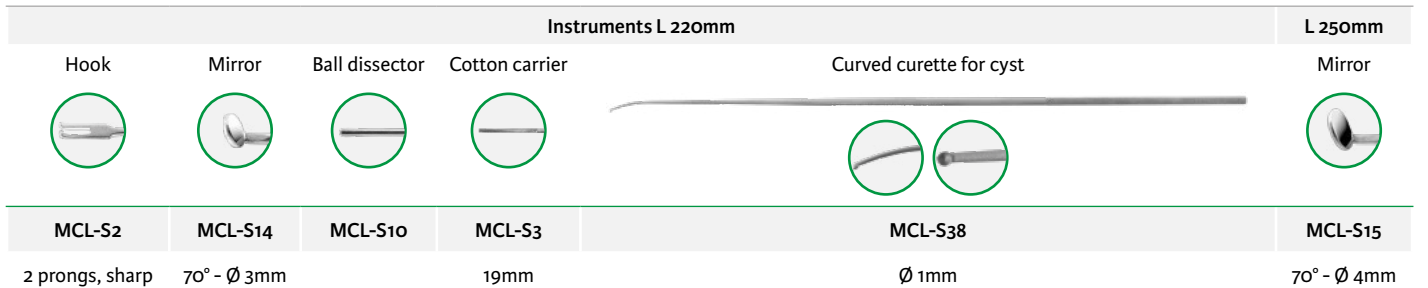
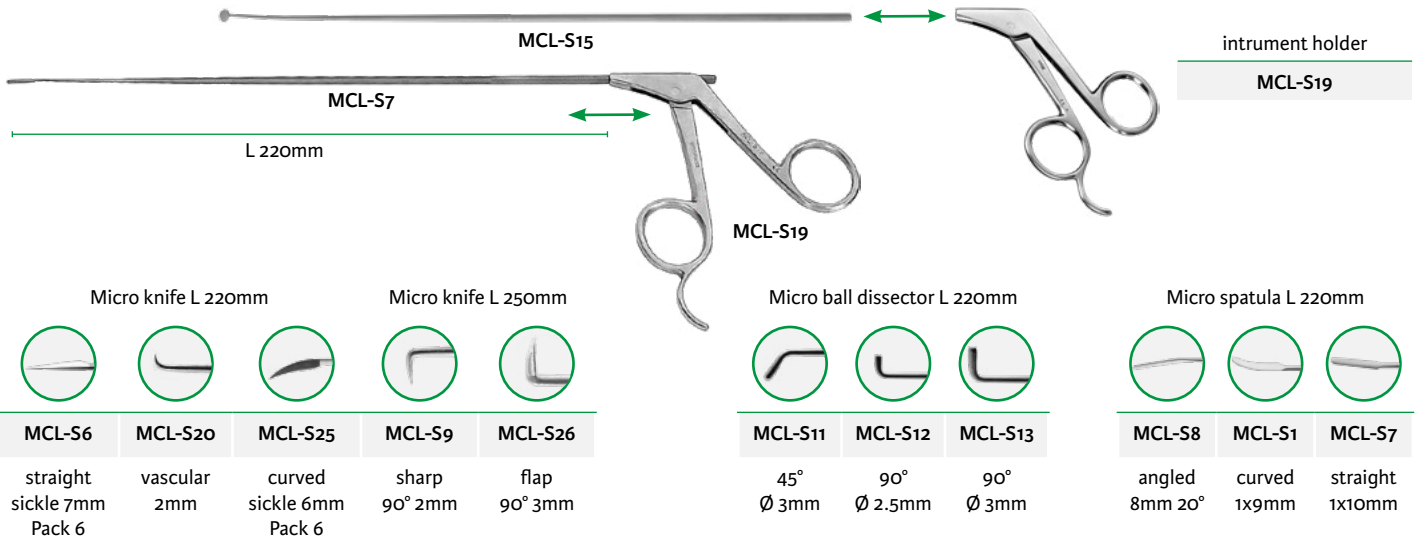

Dismantled instruments for instrument holder MCL-S19

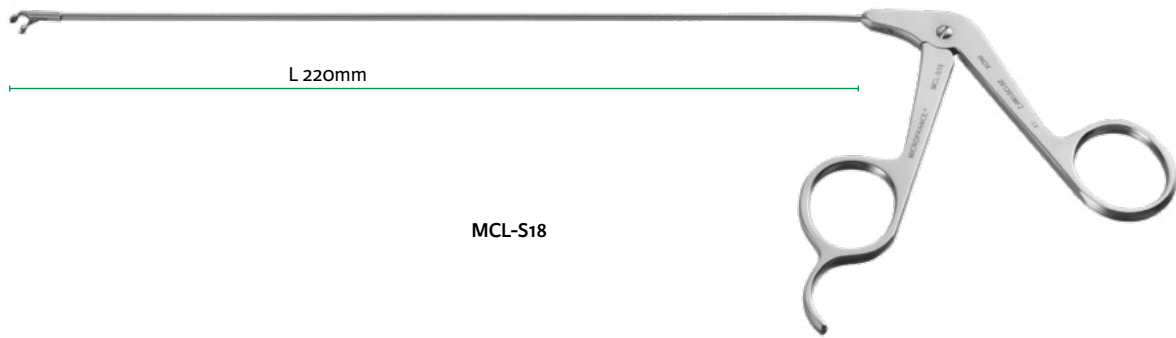

Scale 2/3
Working length - «L»





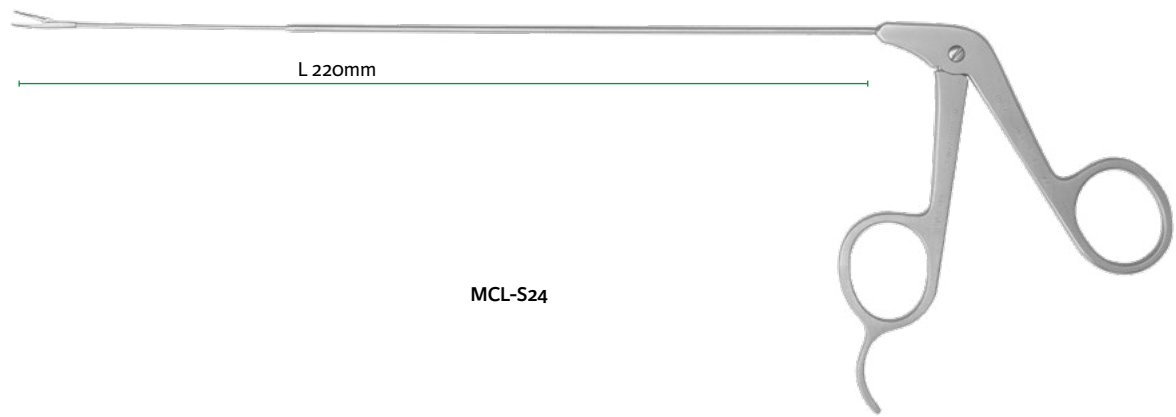

MCL-S18

Cup forceps	Heart-shaped grasper	
		
MCL-S18 downbiting	MCL-S21 right	MCL-S22 left



MCL-S24

Alligator forceps			
			
MCL-S23 right	MCL-S24 left	MCL-S39 fine right jaws	MCL-S41 fine left jaws

Scale 1/3
Working length - «L»

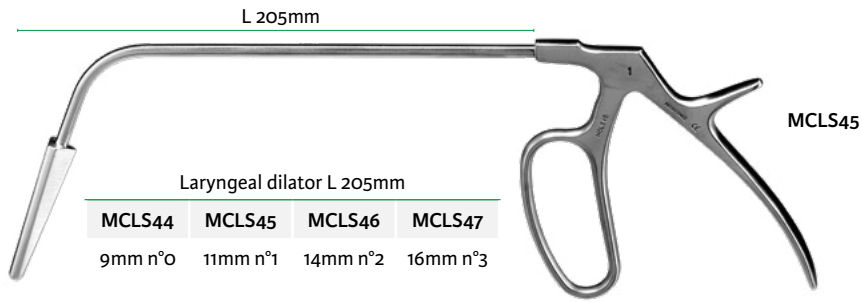

Cup forceps Ø 2.4mm - L 180mm



MCL49	MCL50	MCL51
straight	curved left	curved right

Heart-shaped forceps 45° L 180mm



MCL55	MCL56
Curved left	Curved right

Scissors 3mm blades - L 180mm



MCL52	MCL53	MCL54
straight	curved right	curved left

Alligator forceps Ø 5mm - L 180mm



MCL57	MCL58	MCL59
straight	curved right	curved left

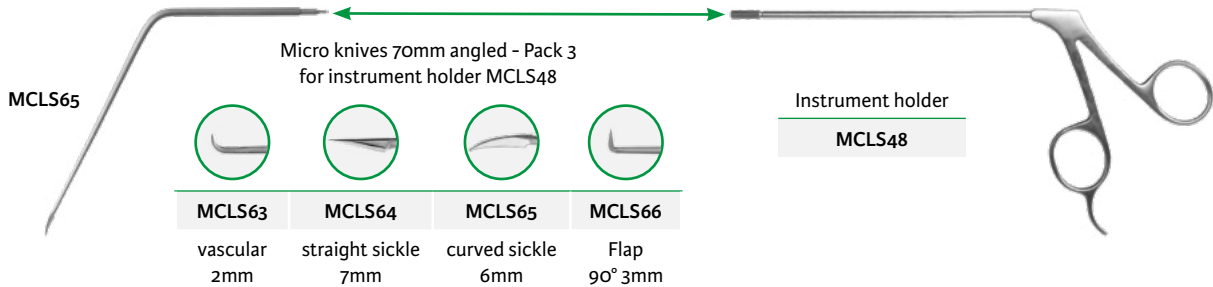

Stainless steel sterilization case
MCL62SC

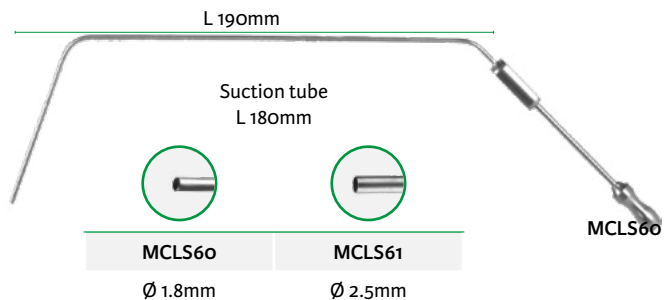

Injection needle Ø 0.7mm - Pack 6

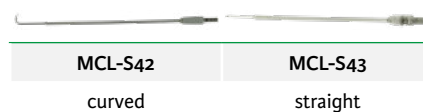

Scale 1/3

Working length 220mm

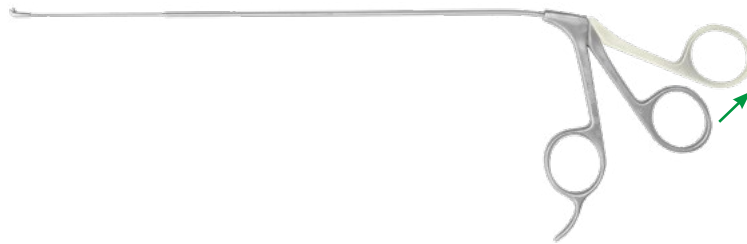

Micro scissors



MCLB16

curved right



MCLB17

curved left



MCLB31

angled 70°

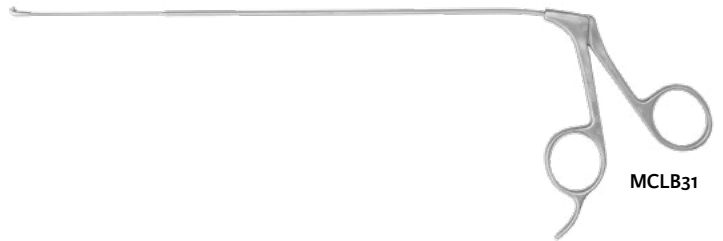

MCLB31

Cup forceps



MCLS18R

280mm

downbiting

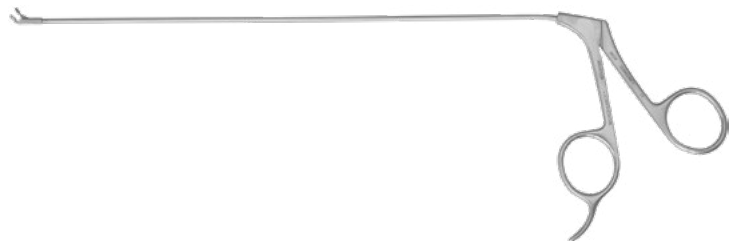

Heart-shaped grasper



MCL-S21R

right



MCL-S22R

left

Alligator forceps

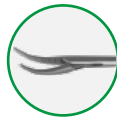

MCL-S23R

right

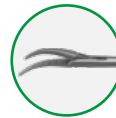

MCL-S24R

left



MCL-S22R

Needle-driver



MCLB94

280mm

angled up 70°



Suture knot pusher



MCLB30

250mm



Scale 1/2
Working length «L»



Trocar holder ring
Ø 10mm

MCLP70

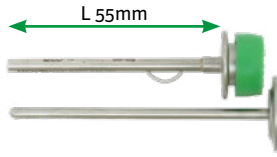

Trocar
with blunt tip

MCLP10

L 55mm

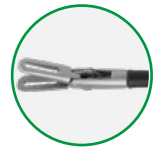

Fenestrated forceps, 3x8mm jaws

MCLP20U

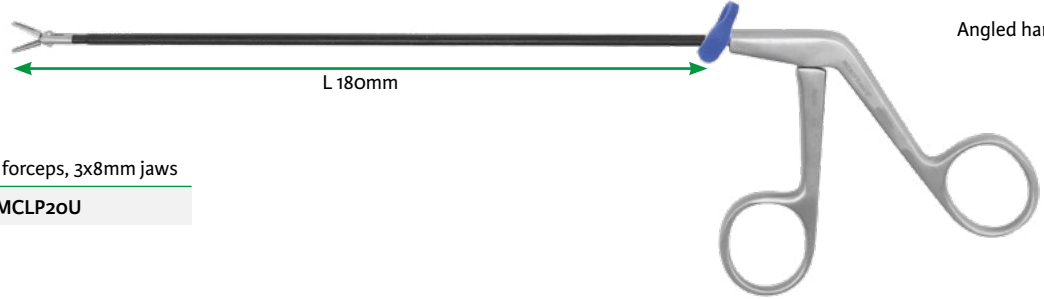

L 180mm

Angled handle



Fenestrated forceps, 3x8mm jaws

MCLP25U

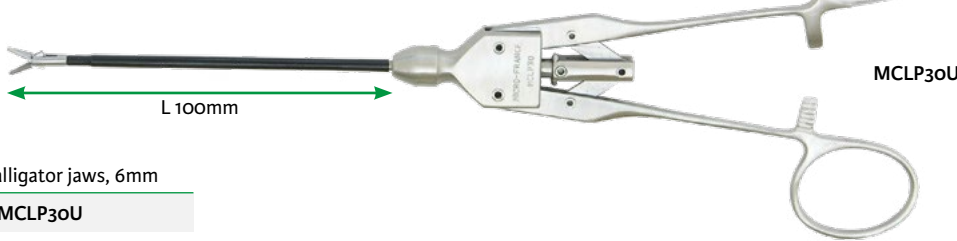

L 100mm

MCLP30U

Axial handle



forceps, alligator jaws, 6mm

MCLP30U



Micro scissors, 4mm blades

MCLP40U

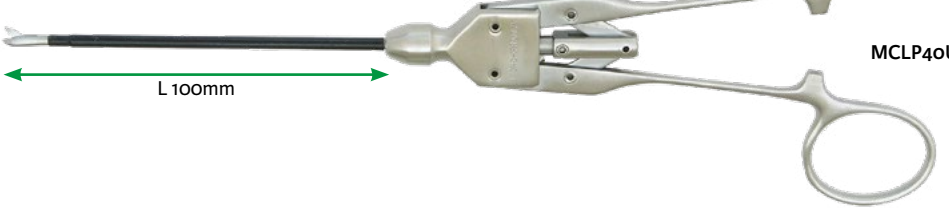

L 100mm

MCLP40U

Axial handle



Monopolar hook

MCLP50



L 100mm

MCLP50









Round palpation probe

MCLP60

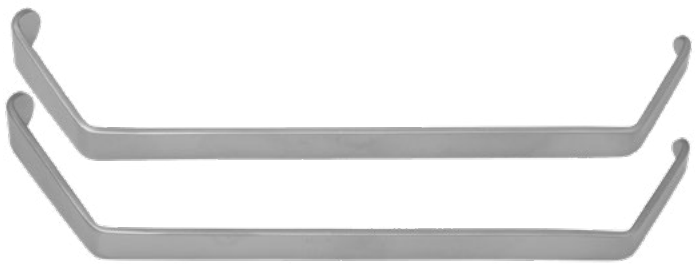

L 180mm

MCLP60







		Blunt retractor 180mm
MCLT10	small tips : 8x35 / 15x40mm	
MCLT11	Large tips : 8x35 / 15x50mm	
		Blunt curved elevator 190mm
MCLT20	2mm	
MCLT21	4mm	
		Suction tube elevator 200mm Ø 3mm
MCLT40	Malleable	
		Nerve eye suction tube with finger control 200mm Ø 3mm
MCLT50	Malleable	
		Peanut holder 200mm Ø 3mm axial handle
MCLT30		

Robotic thyroid surgery

MCLT12R	Muscle retractor	
MCLT13R	Bivalve retractor	
MCLT21R	Ball hook elevator Ø 4mm 440mm	
MCLT40R	Suction elevator, malleable, Ø 3mm 270mm	
MCLT50R	Malleable ner eye suction tube, 330mm	

not shown

Trocar with metal cannula



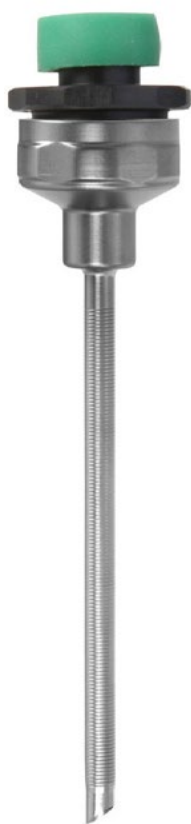



			Working length	
			50 mm	80 mm
Trocar tip	smooth		CEV8143A4	CEV143A4
	pyramidal		CEV8143A3	CEV143A3
Sealing cap	green		CEV103P6 Pack 6	
Trocar head	magnetic		CEV177A3 Delivered complete with 1 magnetic valve and 1 green sealing cap	
	silicone		CEV127T3 Delivered complete with 1 silicone valve and 1 green sealing cap	
Valve for trocar head	magnetic		CEV179A5 Pack 6	
	silicone		CEV125P6 Pack 6	
Metal cannula, crenelated	with stopcock		CEV8143A7	CEV143A7
	without stopcock		CEV8143B7	CEV143B7



Scale 1/1

Composite trocar with silicone valve



			Working length	
			45 mm	70 mm
Trocar tip 	smooth 	CEV8826M (1)	CEV326M (1)	
	pyramidal 	CEV8826P (1)	CEV326P (1)	
Sealing cap	green 	CEV103P6 Pack 6		
Valve for trocar head	silicone 	CEV125P6 Pack 6		
Trocar body composed of 1 trocar head with composite cannula and silicone valve	smooth cannula without stopcock 	CEV8826L (1)	CEV326L (1)	
	threaded cannula without stopcock 	CEV8826V (1)	CEV326V (1)	

(1) New reference

Monopolar hook





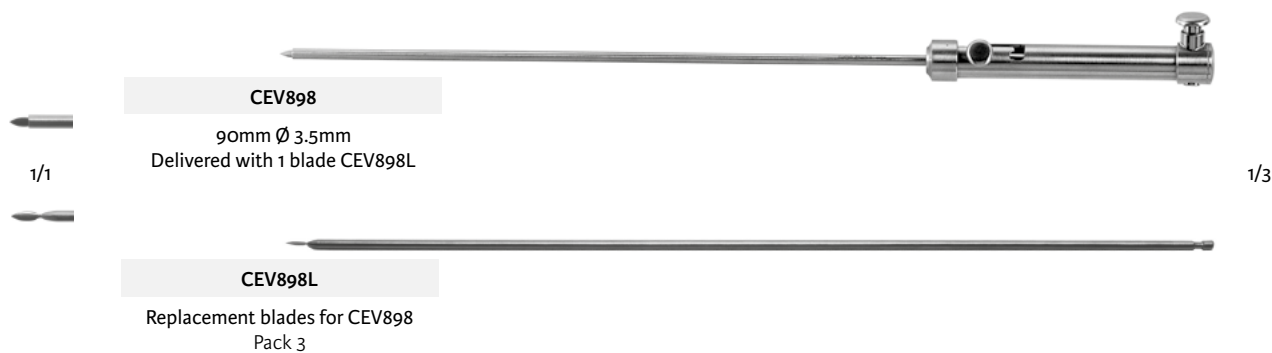



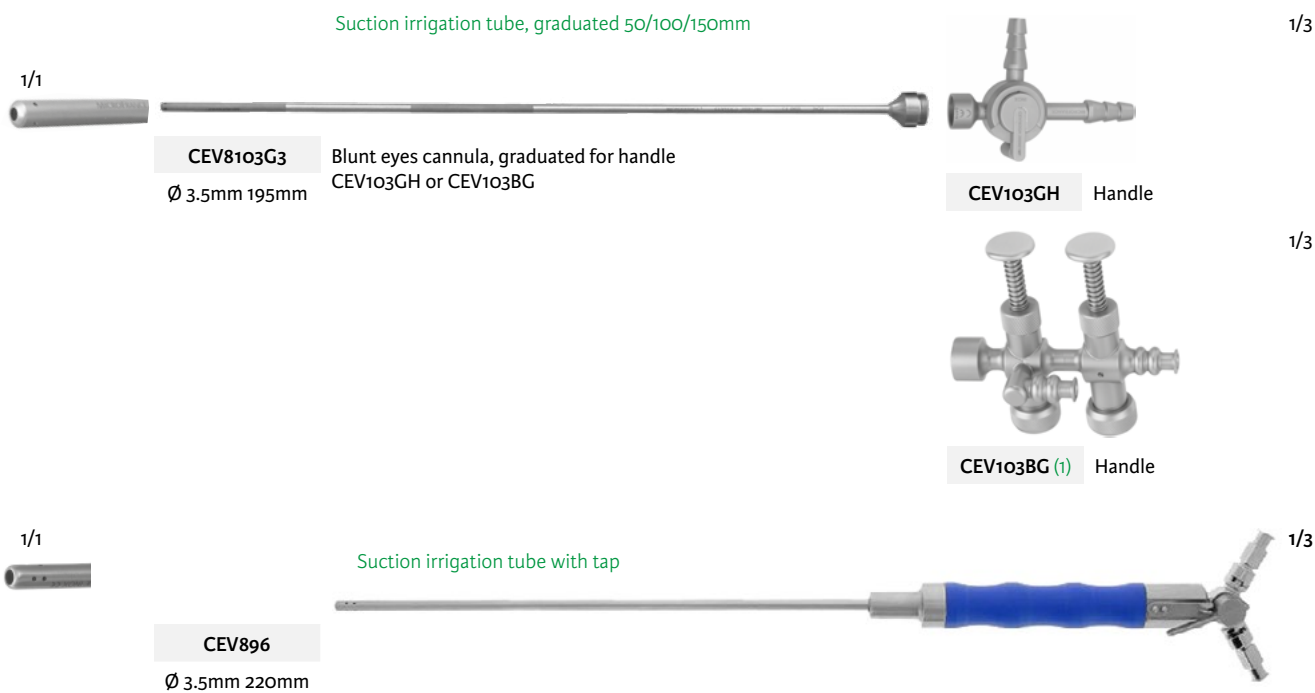

Retractable knife



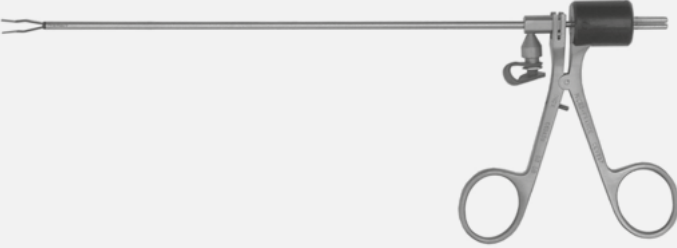





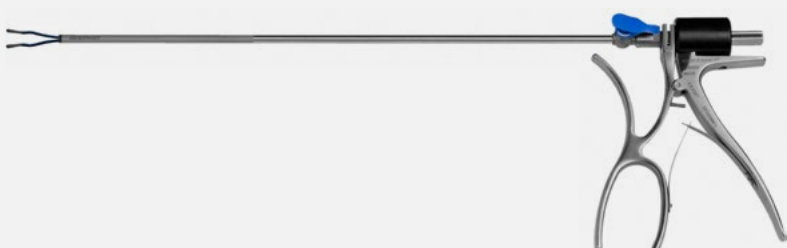







Suction irrigation tube



(1) New reference

1-piece			
Complete instruments : bipolar forceps			
Jaws Scale 1/1	Handle		Working length
 serrated jaws, 1.5mm	 Angled, bipolar		CEV897 250 mm
	 1/3		
 fenestrated jaws, 10x3mm	 «K» handle, bipolar		CEV897BG 250 mm
	 1/3		
 spatula jaws, 2mm	 «K» handle, bipolar		CEV897C 250 mm
	 1/3		

Bipolar cables - 4.5 m		
 CP393-2 Bowa Emc Lamidey Valleylab	 CP393-3 Storz Wolf Erbe (except ICC/VIO international)	 CP393-4 Aesculap Berchtold Martin Sutter BM-780 II

Semi-Modular			
Inserts with tubes		Handle	
Jaws with insulated tube Scale 1/1	Working length	Pages	
	 Babcock insert CEV891IU 235 mm	 Rotatable page 82-83	
 Curved scissors insert serrated blades 8mm CEV893IU 230 mm	 Straight scissors insert serrated blades 8mm CEV894IU 230 mm		
 Fenestrated insert 3x12mm jaws CEV895IU 235 mm	 Grasping insert CEV899IU 220 mm New reference		
 Alligator jaws insert 6mm CEV896IU 235 mm	 Dissector insert medium curved 10mm jaws CEV898IU 230 mm		
 CEV39L Adapter cleaning luer-lock for tube insert			

Modular

Rotatable instruments

Angled handles with black rotatable ring
Scale 1/3



with ratchet

CEV1019T5BU
Large pattern



with ratchet

CEV10195CU



with ratchet

CEV10195DU



with ratchet

CEV10195RU



without ratchet

CEV1039T5TBU
Large pattern



without ratchet

CEV10395DU



without ratchet

CEV10395RU



without ratchet

CEV1039G5U

Modular

Rotatable instruments

Axial handles with black rotatable ring
Scale 1/3

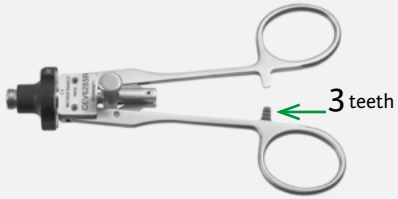

CEV6285R

with ratchet



CEV6385RU

without ratchet



CEV628P5

with ratchet



CEV728T5

with long ratchet

Modular

Rotatable instruments

Ergonomic handles with black rotatable ring
Scale 1/3



Large ergonomic handle
with ratchet

CEV720BRUC



Fine ergonomic handle
with ratchet

CEV720RU











Elhadad
Fine ergonomic handle
with ratchet









CEV7285RU









Large ergonomic handle
with ratchet

CEV728BR5U

1-piece		
Complete instruments		
Jaws Scale 1/1	Handle	Working length
 <p>Montupet Babcock forceps</p>	 <p>Angled with long ratchet</p>	<p>CEV891MU 200 mm</p>
 <p>Montupet Straight scissors serrated blades 8mm</p>	 <p>Angled</p>	<p>CEV894MU 220 mm</p>
 <p>Montupet Fenestrated forceps 3x12mm jaws</p>	 <p>Angled with long ratchet</p>	<p>CEV895MU 195 mm</p>
 <p>Grasping forceps with teeth</p>	 <p>Angled with long ratchet</p>	<p>CEV899U 220 mm New reference</p>

1-piece			
De Lagausie instruments			
Jaws Scale 1/1	Handle		Working length
 De Lagausie Fenestrated forceps 3x12mm jaws	 Axial		CEV995MU 220 mm
 De Lagausie Straight scissors serrated blades 8mm	 Axial		CEV996MU 220 mm
 De Lagausie Alligator forceps 6mm serrated jaws	 Axial		CEV997MU 210 mm
 De Lagausie Dissector medium curved 10mm	 Axial		CEV998MU 220 mm

Needle-holder			
 Montupet Needle-holder straight tungsten jaws	 Angled with long ratchet		CEV892 220 mm
 Reinberg Needle-holder straight tungsten jaws	 Axial		CEV992 220 mm
 Needle-holder left curved tungsten jaws	 Axial		CEV992D 220 mm

Cup



7876-60^(D)*

Cup

7876-60 ^(D) *	60mm
7876-80 ^(D) *	80mm
7876-100 ^(D) *	100mm
7876-120 ^(D) *	120mm
7876-160 ^(D) *	160mm

Stainless steel tray



7872-24^(D)*
Scale 1/2

Stainless steel tray

7872-24 ^(D) *	240x180mm
--------------------------	-----------

^(D) Distributed by Integra MicroFrance SAS (France) - For corresponding manufacturer part numbers, see table in annex
*Please check with your sales representative availability of this product in your country

Scale 1/5

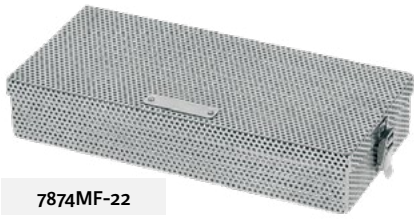

7874MF-22

220x100x40mm

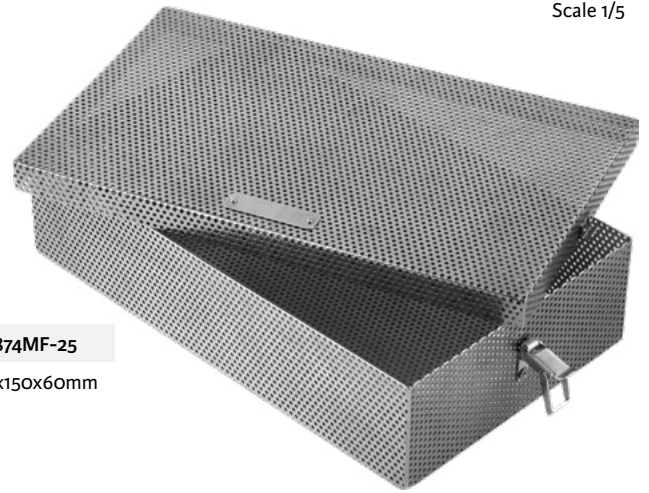

7874MF-25

250x150x60mm

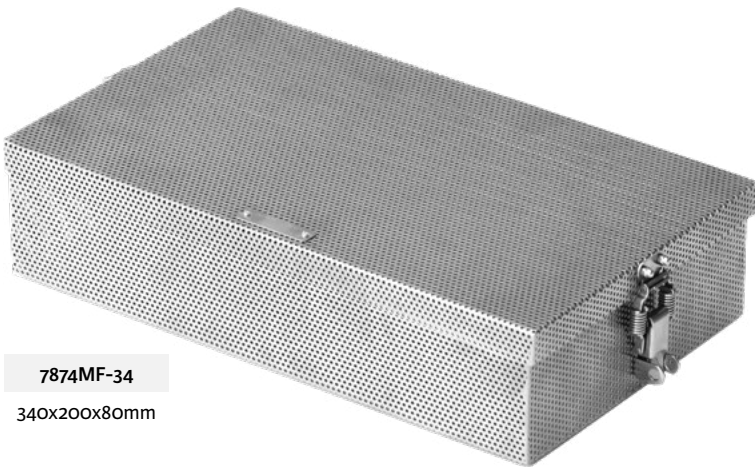

7874MF-34

340x200x80mm

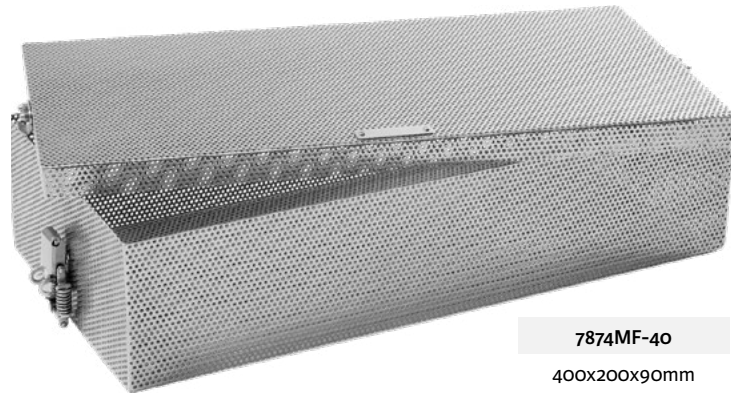

7874MF-40

400x200x90mm

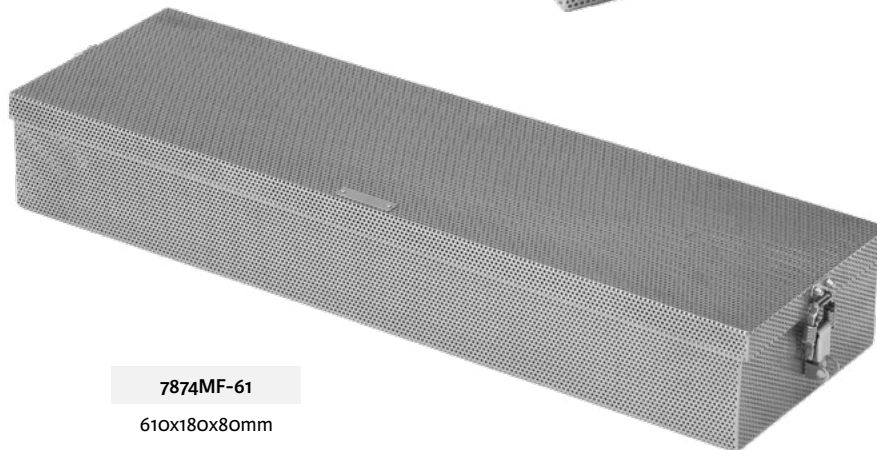

7874MF-61

610x180x80mm

Picture for information, without scale

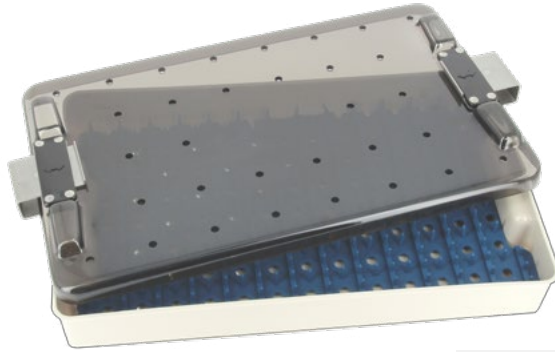

MCEN136SC

270x160x35mm



3717011

528x250x123mm

Picture for information, without scale



3717001

530x250x140mm



3717023

525x250x180mm

Numerical index

0

0-28-7.....	26
-------------	----

1

1003IG(D).....	21
1003LI(D).....	12, 21
1004IG(D).....	21
1005I(D).....	21

3

3714O27.....	25
3714O28.....	25
3717001.....	89
3717011.....	13
3717023.....	90
3724O59.....	22
3734O42.....	13
3734115.....	68

7

701T.....	49
702T.....	48
703T.....	48
704T.....	48
714T.....	48
720T.....	49
7755-1-0-4.....	15
7755-1-0-5.....	15
7755-1-0-6.....	15
7768.....	24
7768-1.....	24
7773.....	28
7781.....	27
7782-1-2.....	25
7787-10.....	22
7796.....	2
7797-1.....	10
7797-2.....	10
7798T1(D).....	2
7798T(D).....	2
7800MF.....	10
7802C.....	4
7802P.....	3, 4, 9
7802S-1.....	4
7802S-2.....	4
7802S-3.....	4
7802S-4.....	4
7802S-5.....	4
7803B.....	4

7803C.....	3
7803S-1.....	3
7803S-2.....	3
7803S-3.....	3
7804-9.....	6
7804-11.....	6
7804-13.....	6
7805-11.....	6
7805-13.....	6
7808L-1.....	15
7808L-2.....	15
7808L-3.....	15
7808M.....	15
7809MF.....	5
7810.....	15
7811.....	12
7812.....	12
7813.....	15
7813-1.....	15
7814.....	12
7814M.....	12
7815.....	12
7819.....	11
7820.....	11
7821A.....	5
7821B.....	5
7822.....	11
7823.....	11
7825.....	11
7826-1-7.....	11
7828-1-10.....	14
7828-1-13.....	14
7828-1-16.....	14
7828-1-19.....	14
7828-10.....	14
7828-13.....	14
7828-16.....	14
7828-19.....	14
7829-10.....	14
7829-13.....	14
7829-16.....	14
7829-19.....	14
7830M.....	16
7831A-12.....	37
7831A-15.....	39
7831A-18.....	41
7831A-20.....	42
7832.....	42
7833A-12.....	37
7833A-15.....	39
7833A-18.....	41
7833A-20.....	42
7834.....	42

7835.....	16
7837-18.....	16
7838.....	16
7839.....	16
7840.....	16
7843-1.....	55
7843A-1.....	55
7844T3L20.....	55
7844T3L25.....	55
7844T3L30.....	55
7844T3L35.....	55
7844T3L40.....	54
7844T3L45.....	54
7844T3L50.....	54
7844T3L55.....	54
7844T3L60.....	54
7844T5L20.....	55
7844T5L25.....	55
7844T5L30.....	55
7844T5L35.....	55
7844T5L40.....	54
7844T5L45.....	54
7844T5L50.....	54
7844T5L55.....	54
7844T5L60.....	54
7844T6L20.....	55
7844T6L25.....	55
7844T6L30.....	55
7844T6L35.....	55
7844T6L40.....	54
7844T6L45.....	54
7844T6L50.....	54
7844T6L55.....	54
7844T6L60.....	54
7844T74L20.....	55
7844T74L25.....	55
7844T74L30.....	55
7844T74L35.....	55
7844T74L40.....	54
7844T74L45.....	54
7844T74L50.....	54
7844T74L55.....	54
7844T74L60.....	54
7857.....	10
7866-13.....	53
7867-1.....	50
7867-2.....	50
7867-3.....	50
7867-4.....	50
7872-24(D).....	87
7874MF-22.....	88
7874MF-25.....	88
7874MF-34.....	9, 88

^(D) Distributed by Integra MicroFrance SAS (France) - For corresponding manufacturer part numbers, see table in annex

7874MF-40.....	88
7874MF-61.....	54, 88
7876-60(D).....	87
7876-80(D).....	87
7876-100(D).....	87
7876-120(D).....	87
7876-160(D).....	87
7878.....	12
7879.....	12
7884.....	12
7895.....	12
7920.....	16
7921.....	16
7923.....	29
7945T.....	49
7960T40(D).....	3, 5, 9

CEV

CEV39L.....	81
CEV103BG.....	79
CEV103GH.....	79
CEV103P6.....	77, 78
CEV125P6.....	77, 78
CEV127T3.....	77
CEV143A3.....	77
CEV143A4.....	77
CEV143A7.....	77
CEV143B7.....	77
CEV177A3.....	77
CEV179A5.....	77
CEV326L.....	78
CEV326M.....	78
CEV326P.....	78
CEV326V.....	78
CEV392D20.....	45
CEV392D30.....	45
CEV392G24.....	45
CEV392P20.....	45
CEV392R15.....	45
CEV392S20.....	45
CEV417.....	29
CEV418.....	29
CEV419.....	29
CEV628P5.....	83
CEV720BRUC.....	84
CEV720RU.....	84
CEV728BR5U.....	84
CEV728T5.....	83
CEV890.....	79
CEV890C.....	79
CEV891MU.....	85
CEV892.....	86

CEV894MU.....	85
CEV895MU.....	85
CEV896.....	79
CEV897.....	80
CEV897BG.....	80
CEV897C.....	80
CEV898.....	79
CEV898L.....	79
CEV899U.....	85
CEV984.....	57
CEV992.....	86
CEV992D.....	86
CEV995MU.....	86
CEV996MU.....	86
CEV997MU.....	86
CEV998MU.....	86
CEV1019T5BU.....	82
CEV1039G5U.....	82
CEV1039T5TBU.....	82
CEV6285R.....	83
CEV6385RU.....	83
CEV7285RU.....	84
CEV8103G3.....	79
CEV8143A3.....	77
CEV8143A4.....	77
CEV8143A7.....	77
CEV8143B7.....	77
CEV8826L.....	78
CEV8826M.....	78
CEV8826P.....	78
CEV8826V.....	78
CEV10195CU.....	82
CEV10195DU.....	82
CEV10195RU.....	82
CEV10395DU.....	82
CEV10395RU.....	82

CP

CP16.....	30
CP16-1.....	30
CP17.....	24
CP17-1.....	24
CP17-2.....	24
CP17-3.....	24
CP21-3.....	25
CP21A-3.....	25
CP37.....	37
CP310.....	23
CP310D.....	23
CP310E.....	23
CP330-3-0.....	19
CP330-4-0.....	19

CP332.....	37
CP335.....	25
CP335P.....	29
CP344A.....	23
CP344AT.....	23
CP344B.....	23
CP344BT.....	23
CP344C.....	23
CP344CT.....	23
CP344D.....	23
CP344DT.....	23
CP344E.....	23
CP344ET.....	23
CP345.....	40
CP351-1.....	35
CP351-2.....	34
CP351-3.....	34
CP351-5.....	35
CP351-6.....	34
CP351-7.....	34
CP352.....	36
CP352-1.....	36
CP352-2.....	36
CP352-3.....	36
CP353.....	30
CP354.....	30
CP354A.....	30
CP355.....	31
CP355A.....	31
CP355C.....	33
CP356.....	30
CP358.....	30
CP358A.....	30
CP362.....	31
CP363.....	32
CP365.....	33
CP367.....	31
CP367-1.....	31
CP390-1.....	47
CP390-2.....	47
CP390-3.....	46
CP390-5.....	46
CP390-7.....	46
CP390-8.....	47
CP390L26.....	46
CP391E.....	12, 46, 47, 66, 69
CP391M.....	12, 46, 47, 66, 69
CP391V.....	12, 46, 47, 66, 69
CP392-1R.....	43
CP392-2R.....	43
CP392-3R.....	44
CP392-5R.....	44
CP392-8R.....	43

^(D) Distributed by Integra MicroFrance SAS (France) - For corresponding manufacturer part numbers, see table in annex

CP392-9R.....	44
CP392-10R.....	44
CP392Bl.....	43
CP392BS.....	43
CP393-2.....	43, 44, 45, 69, 80
CP393-3.....	43, 44, 45, 69, 80
CP393-4.....	43, 44, 45, 69, 80
CP400.....	39
CP400-1.....	37
CP400-2.....	41
CP401.....	40
CP406.....	37
CP407.....	39
CP409.....	41
CP414.....	37
CP415.....	39
CP604.....	38
CP604-15.....	38
CP604BR.....	43
CP604M.....	47
CP605.....	38
CP605-15.....	38
CP605BR.....	43
CP605M.....	47
CP606.....	38
CP606-15.....	38
CP606A.....	38
CP609.....	25
CP611.....	20
CP616-13.....	33
CP616-15.....	33
CP625.....	20
CP626.....	20
CP627.....	20
CP628.....	24
CP637.....	32
CP818-8.....	28
CP818-10.....	28
CP818-12.....	28
CP818-15.....	28
CP818-20.....	28
CP821.....	21
CP821E.....	67
CP822-10.....	24
CP822-12.....	24
CP822-14.....	24
CP825.....	22
CP919.....	30
CP919A.....	30
CP921.....	33
CP922.....	32
CP922A.....	32
CP922B.....	32
CP931.....	34

CP931-1.....	34
CP931-3.....	35
CP931-5.....	35
CP933-14.....	39
CP933-16.....	40
CP933-18.....	41
CP934.....	39
CP934-1.....	39
CP936.....	40
CP938-1.....	37
CP941.....	24
CP984.....	28
CP984-1.....	28
CP985.....	20
CP988-15.....	39
CP988-18.....	41
CP988-20.....	42
CP997.....	31
CP1107.....	48

MCL35.....	9, 57
MCL37.....	58
MCL37C.....	58
MCL37CF.....	58
MCL37D.....	58
MCL37DF.....	58
MCL37G.....	58
MCL38N(D).....	9, 57
MCL42.....	58
MCL46.....	60
MCL46A.....	60
MCL47.....	60
MCL48.....	67
MCL49.....	56
MCL49F.....	56
MCL51.....	58
MCL52.....	58
MCL53.....	58
MCL54.....	58
MCL55.....	70
MCL55-1.....	70
MCL55-2.....	70
MCL55-3.....	70
MCL55B.....	70
MCL55R.....	70
MCL55T4.....	70
MCL55T5.....	70
MCL55T6.....	70
MCL55U.....	70
MCL56BL.....	64
MCL56BR.....	64
MCL56PL.....	65
MCL56PR.....	65
MCL57.....	64
MCL58.....	68
MCL59.....	69
MCL62.....	69
MCL63.....	59
MCL63F.....	59
MCL64.....	59
MCL64F.....	59
MCL65A.....	60
MCL65AF.....	60
MCL65AS.....	60
MCL67.....	63
MCL68.....	63
MCL69.....	63
MCL76.....	9, 57
MCL77.....	59
MCL78.....	59
MCL79.....	59
MCL81BL.....	64
MCL81BR.....	64
MCL81PL.....	65

M

M832.....	38
M833.....	38

MCEN

MCEN39L.....	65, 67
MCEN136SC.....	89
MCEN770J30.....	19
MCEN770J40.....	19

MCL

MCL1BIS.....	67
MCL4.....	67
MCL5.....	67
MCL7.....	67
MCL10.....	62
MCL11.....	64
MCL12.....	63
MCL15.....	63
MCL16.....	64
MCL17.....	64
MCL18.....	63
MCL19.....	63
MCL19BIS.....	63
MCL25.....	63
MCL29.....	63
MCL30.....	63
MCL31.....	64
MCL33.....	63
MCL34.....	69

MCL81PR.....	65
MCL82.....	64
MCL83.....	60
MCL83-1.....	60
MCL84.....	60
MCL88.....	56
MCL88-1.....	56
MCL88-2.....	56
MCL89.....	60
MCL89-1.....	9, 56, 60
MCL89-2.....	9, 60
MCL93.....	64
MCL93-2.....	64
MCL94.....	64
MCL94G.....	67
MCL94IG.....	67
MCL94IP.....	65
MCL94IPR.....	65
MCL98.....	68
MCL100.....	9, 62
MCL100T15.....	62
MCL100T20.....	62
MCL101.....	68
MCL102.....	68
MCL103.....	62
MCL110.....	55
MCL111.....	55
MCL112.....	55
MCL112F.....	55
MCL112H.....	54, 55
MCL120.....	61
MCL121.....	61
MCL122.....	61
MCL123.....	61
MCL124.....	61
MCL124FL.....	61
MCL124FR.....	61
MCL124ST.....	61
MCL125.....	61
MCL125FL.....	61
MCL125FR.....	61
MCL125ST.....	61
MCL170(D)(1).....	9, 57
MCL171(D)(1).....	9, 57
MCL173(D)(1).....	9, 57
MCL174(D)(1).....	9, 57
MCL197(D)(1).....	9, 57
MCL205.....	66
MCL206.....	8
MCL206A1.....	7, 8
MCL206A2.....	8
MCL206A3.....	8
MCL206A4.....	8
MCL206A5.....	8

MCL206A6.....	8
MCL206A7.....	8
MCL206C.....	7, 8
MCL206K.....	8
MCL206P.....	7, 8
MCL210.....	62, 66
MCL219.....	66
MCL219-1.....	66
MCL241.....	66
MCL241-1.....	66
MCL290.....	60
MCL291.....	60
MCL291AD.....	60
MCL291AG.....	60
MCL291FD.....	60
MCL291FG.....	60
MCL294.....	60
MCL295.....	60
MCL320.....	54
MCL320F.....	54
MCL330.....	54
MCL330F.....	54
MCL340.....	69
MCL359.....	27
MCL828.....	65
MCL828C.....	67
MCL920L25.....	55
MCL920L30.....	56
MCL920L35.....	55
MCL920L45.....	54
MCL920L55.....	54
MCL925L25.....	55
MCL925L30.....	56
MCL925L35.....	55
MCL925L45.....	54
MCL925L55.....	54
MCL930L25.....	55
MCL930L30.....	56
MCL930L35.....	55
MCL930L45.....	54
MCL930L55.....	54
MCL935L25.....	55
MCL935L30.....	56
MCL935L35.....	55
MCL935L45.....	54
MCL935L55.....	54
MCL940L25.....	55
MCL940L30.....	56
MCL940L35.....	55
MCL940L45.....	54
MCL940L55.....	54

MCLB

MCLB16.....	74
MCLB17.....	74
MCLB30.....	74
MCLB31.....	74
MCLB94.....	74

MCLP

MCLP10.....	75
MCLP20U.....	75
MCLP25U.....	75
MCLP30U.....	75
MCLP40U.....	75
MCLP50.....	75
MCLP60.....	75
MCLP70.....	75

MCL-S

MCL-S0.....	71
MCL-S1.....	71
MCL-S2.....	71
MCL-S3.....	71
MCL-S4.....	71
MCL-S5.....	71
MCL-S6.....	71
MCL-S7.....	71
MCL-S8.....	71
MCL-S9.....	71
MCL-S10.....	71
MCL-S11.....	71
MCL-S12.....	71
MCL-S13.....	71
MCL-S14.....	71
MCL-S15.....	71
MCL-S16.....	62
MCL-S17.....	62
MCL-S17-1.....	62
MCL-S18.....	72
MCL-S18R.....	74
MCL-S19.....	71
MCL-S20.....	71
MCL-S21.....	72
MCL-S21R.....	74
MCL-S22.....	72
MCL-S22R.....	74
MCL-S23.....	72
MCL-S23R.....	74
MCL-S24.....	72
MCL-S24R.....	74
MCL-S25.....	71
MCL-S26.....	71

⁽¹⁾ Not a medical product

⁽²⁾ Distributed by Integra MicroFrance SAS (France) - For corresponding manufacturer part numbers, see table in annex

MCL-S27.....	71
MCL-S35.....	71
MCL-S38.....	71
MCL-S39.....	72
MCL-S41.....	72
MCL-S42.....	73
MCL-S43.....	73
MCLS44.....	73
MCLS45.....	73
MCLS46.....	73
MCLS47.....	73
MCLS48.....	73
MCLS49.....	73
MCLS50.....	73
MCLS51.....	73
MCLS52.....	73
MCLS53.....	73
MCLS54.....	73
MCLS55.....	73
MCLS56.....	73
MCLS57.....	73
MCLS58.....	73
MCLS59.....	73
MCLS60.....	73
MCLS61.....	73
MCLS62SC.....	73
MCLS63.....	73
MCLS64.....	73
MCLS65.....	73
MCLS66.....	73
MCLS120-1.....	61
MCLS120-2.....	61
MCLS120-3.....	61
MCLS121-1.....	61
MCLS121-2.....	61
MCLS121-3.....	61
MCLS122-1.....	61
MCLS122-2.....	61
MCLS122-3.....	61
MCLS123-1.....	61
MCLS123-2.....	61
MCLS1233.....	61

MCLT

MCLT10.....	76
MCLT11.....	76
MCLT12R.....	76
MCLT13R.....	76
MCLT20.....	76
MCLT21.....	76
MCLT21R.....	76

MCLT30.....	76
MCLT40.....	76
MCLT40R.....	76
MCLT50.....	76
MCLT50R.....	76

MCLW

MCLW10.....	68
MCLW11.....	68

MCM

MCM1R.....	18
MCM4BISR.....	17
MCM4R.....	17
MCM7BISR.....	18
MCM7R.....	18
MCM10-0-5.....	17
MCM10-1-0.....	17
MCM12R.....	18
MCM13.....	17
MCM13-1.....	17
MCM25-3.....	9, 18
MCM970.....	18
MCM973D3.....	17
MCM973D5.....	17

MCO

MCO201-2-5.....	19
MCO201-3-0.....	19
MCO305.....	20
MCO770-1-5.....	19
MCO770-2-0.....	19
MCO770-2-5.....	19
MCO770-3-0.....	19
MCO770-3-5.....	19
MCO770-4-0.....	19
MCO771-2-5.....	19
MCO771-3-0.....	19
MCO771-4-0.....	19
MCO803.....	20
MCO979.....	22
MCO988.....	22

MCR

MCR2A.....	3
MCR3A.....	3

P

P761-7.....	50
P761-8.....	50
P762-2.....	51
P762-4.....	51
P763.....	52
P764-1.....	51
P764-3.....	51
P764-5.....	51
P764-7.....	51
P764-11.....	51
P765-14.....	52
P765-16.....	52
P769.....	52
P770.....	53
P771.....	53

S

SM63(D).....	67
SM64(D).....	67
SM65(D).....	67

^(D) Distributed by Integra MicroFrance SAS (France) - For corresponding manufacturer part numbers, see table in annex



**Table for corresponding
manufacturer part numbers
For information purposes only**

Integra MicroFrance® product reference	Corresponding manufacturer part number
1003IG	M3IG
1003LI	M3LI
1004IG	M4IG
1005I	M5I
7798T	101
7798T1	101 B
7872-24	1224
7876-100	310
7876-120	312
7876-160	316
7876-60	306
7876-80	308
7960T40	731901
MCL170 ⁽¹⁾	CO101
MCL171 ⁽¹⁾	CO201
MCL173 ⁽¹⁾	CO100
MCL174 ⁽¹⁾	CO200
MCL197 ⁽¹⁾	CO103
MCL38N	EC-BLU50U090
SM63	SM63
SM64	SM64
SM65	SM65

⁽¹⁾ Not a medical device

Integra® MicroFrance®

Integra ENT - Throat catalogue



Integra MicroFrance SAS (France)
Le Pavillon ■ 03160 Saint Aubin le Monial ■ France



Swann Morton Ltd
Penn Works ■ Owlerton Green ■ Sheffield
South Yorkshire S6 2BJ ■ Royaume Uni



Emergo Europe
Prinsessegracht 20
2514 AP The Hague ■ The Netherlands

CE Class I products only :



Agencinox
Zone Industrielle
89110 Aillant sur Tholon ■ France



Directa AB
Box 723
19427 Upplands Vasby ■ Suède



Sunoptic Technologies
6018 Bowdendale Avenue
Jacksonville 32216 ■ Florida USA



AJW Technology Consulting GmbH
Breite Straße 3
40213 Düsseldorf ■ Germany

Availability of these products might vary from a given country or region to another, as a result of specific local regulatory approval or clearance requirements for sale in such country or region.

- Consult product labels and inserts for any indications, contraindications, hazards, warnings, precautions, and instructions for use.
- Non contractual document. The manufacturer reserves the right, without prior notice, to modify the products in order to improve their quality.
- Warning: Applicable laws restrict these products to sale by or on the order of a physician.

Additional information for EMEA Customers only :

Products mentioned in this document are CE class I, Is, IIa or IIb devices. Contact Integra should you need any additional information on devices classification.
All the medical devices mentioned on this document are CE marked in accordance with the applicable European laws, unless specifically identified as "NOT CE MARKED".
Products marked with the symbol^(®) are distributed by Integra MicroFrance SAS (France)

Date of last revision : 03/2023

For more information, please contact customer service :

Europe, Middle-East, Africa

International: +33 (0) 437 47 59 50 ■ +33 (0) 437 47 59 25 (Fax) ■ csema@integralife.com
France: +33 (0) 437 47 59 10 ■ +33 (0) 437 47 59 29 (Fax) ■ custservfrance@integralife.com
United Kingdom: +44 (0) 1264 312 725 ■ +44 (0) 1264 312 821 (Fax) ■ custsvcs.uk@integralife.com
Belgium & Luxembourg: +32 (0)2 257 4130 ■ +32 (0)2 253 2466 (Fax) ■ custsvcbenelux@integralife.com
Netherlands: +31(0) 852 083 167 ■ +31(0) 207 093 627 (Fax) ■ custsvcnetherlands@integralife.com
Italy: +39 (0)2 577 8921 ■ +39 (0)2 575 113 71 (Fax) ■ custsvitaly@integralife.com
integralife.eu/contact

Integra and the Integra logo are registered trademarks of Integra LifeSciences Corporation or its subsidiaries in the United States and/or other countries.

MicroFrance is a trademark of Integra LifeSciences Corporation or its subsidiaries.
All other trademarks and product names are the property of their respective owners.

© 2023 Integra LifeSciences Corporation. All rights reserved.

0335699-5-EN

DOCUMENT FOR USE IN EUROPE, MIDDLE-EAST AND AFRICA ONLY.