



**Integra<sup>®</sup> MicroFrance<sup>®</sup>**  
Integra ENT - Nose catalogue

<b>Table of contents</b>	ii	<b>Other Rasps</b>	37
<b>Warranty and Customer Service Information</b>	iv	<b>Nasal splint, cartilage template</b>	38
<b>Indications / Contraindications</b>	v	<b>Crushing press, Perforator bone forceps</b>	39
<b>Diagnosis</b>	2-3	<b>Punch rongeur forceps</b>	40
Air bag	2	<b>Double-action rongeur</b>	41-42
Angled probe caustic holder	3	<b>Double-action bone rongeur</b>	43
Blunt hook	3	<b>Septum forceps</b>	44
Cotton carrier	3	<b>Small scissors, pointed blades, matt finish</b>	45
Electrode Cautery	2	<b>Small scissors, pointed blades</b>	46
Eustachian catheter probe	2	<b>Long scissors, pointed blades</b>	47
Screws speculum	2	<b>Small scissors, blunt blades, matt finish</b>	48
Spring speculum	2	<b>Small scissors, blunt blades</b>	49
<b>Speculum with handle</b>	4	<b>Long scissors, blunt blades</b>	50
<b>Speculum with handle - Fiberoptic</b>	5	<b>Small Metzenbaum scissors, matt finish</b>	51
<b>Flexible tension arm</b>	6	<b>Mayo scissors, beveled blades, matt finish</b>	52
<b>Angled dissecting forceps</b>	7	<b>Angled scissors, dorsal scissors, lower lateral scissors</b>	53
<b>Angled forceps</b>	8	<b>Dural scissors - Scissors, serrated blades</b>	54
<b>Syringe</b>	9	<b>Fine dissecting forceps</b>	55
<b>Elevator, raspatory</b>	10-11	<b>Adson dissecting forceps</b>	56
<b>Suction tube elevator</b>	12-13	<b>Medium dissecting forceps</b>	57-58
<b>Scalpel</b>	14	<b>Dissecting forceps, 180mm</b>	59-60
<b>Knife</b>	15	<b>Dissecting forceps, 200mm</b>	61
<b>Raspatory</b>	16-17	<b>Medium bipolar dissecting forceps</b>	62
<b>Retractor</b>	18-23	<b>Medium monopolar dissecting forceps</b>	63
<b>Curette</b>	24-25	<b>Tungsten needle-holder</b>	64
<b>Mallet</b>	26-27	<b>Fine haemostatic forceps</b>	65
<b>Chisel - Gouge</b>	28	<b>Medium haemostatic forceps</b>	66
<b>Osteotome</b>	29	<b>Haemostatic forceps, serrated jaws - Forceps with teeth</b>	67
<b>Guarded osteotome</b>	30	<b>Forceps with teeth</b>	68
<b>Double guarded osteotome</b>	31	<b>Suction tube with finger control</b>	69
<b>Fine osteotome</b>	32	<b>Micro suction tube - adapters</b>	70
<b>Other osteotomes</b>	33	<b>Blunt suction tube</b>	71-72
<b>Straight rasp</b>	34		
<b>Curved rasp</b>	35		
<b>Double-ended rasp, 210 mm</b>	36		

<b>Frazier suction irrigation system</b>	73	<b>Wormald frontal instrumentation</b>	102
<b>Dessi electric irrigation pump accessories</b>	74	<b>Wormald skull base instrumentation</b>	103-104
Irrigation tubing	74	<b>Stamm skull base instrumentation</b>	105
Sleeve for telescope	74	<b>Sterilization case, tray, cup</b>	106
<b>Irrigation tube guide, trocar</b>	75	<b>Plastic sterilization case</b>	107
<b>Displacer elevator</b>	76	<b>Numerical index</b>	109
<b>Seeker, pick</b>	77	<b>Table for corresponding manufacturer part numbers For information purposes only</b>	117
<b>Knife - Elevator</b>	78		
Dissector and knife	78		
Knife	78		
Sickle knife	78		
<b>Fenestrated cup forceps</b>	79		
<b>De Gabory cup forceps</b>	80		
<b>Jankowski cup forceps</b>	81		
<b>Rouvier cup forceps</b>	82		
<b>Weil-Blakesley cup forceps</b>	83		
<b>Pediatric cup forceps</b>	84		
<b>Fenestrated cup forceps</b>	85		
<b>Cup forceps, curved down</b>	86		
<b>Backbiting punch forceps</b>	87		
<b>Pediatric backbiting punch forceps</b>	88		
<b>Micro punch forceps</b>	89		
<b>Micro fine punch cutting forceps</b>	90		
<b>Micro punch rongeur</b>	91		
<b>Nasal sinus scissors - Scissors, serrated blades</b>	92		
<b>Clip applier</b>	93		
<b>Micro bipolar forceps</b>	94		
<b>Micro bipolar forceps with suction</b>	95		
<b>Micro monopolar instruments</b>	96		
<b>Lemoine , Klossek, Kennedy instruments</b>	97		
<b>Vaughan Instruments</b>	98		
<b>Parsons Instruments</b>	99		
<b>Duncavage Instruments</b>	100		
<b>Levine orbital instrumentation</b>	101		

## Integra Limited Warranty

Please refer to the warranty included in the packaging of each product to know the applicable warranty.

## Contacts Customer service:

### International

+33 (0) 4 37 47 59 50  
+33 (0) 4 37 47 59 25 (fax)  
csemea@integralife.com

### France

+33 (0) 4 37 47 59 10  
+33 (0) 4 37 47 59 29 (Fax)  
custservfrance@integralife.com

### Belgium & Luxembourg

+32 (0) 2 257 4130  
+32 (0) 2 253 2466 (Fax)  
custsvcbenelux@integralife.com

### United Kingdom

+44 (0) 1264 312 725  
+44 (0) 1264 312 821 (Fax)  
custsvcs.uk@integralife.com

### Netherlands

+31(0) 852 083 167  
+31(0) 207 093 627 (Fax)  
custsvcnetherlands@integralife.com

### Italy

+39 (0) 2 577 8921  
+39 (0) 2 575 113 71 (Fax)  
custsvcitaly@integralife.com

**MicroFrance® ENT Instrumentation**

**INDICATIONS**

- All the medical devices showed in this catalogue have indications for diagnosis and/or ENT surgery.
- Sizes are not contractual and are given for information purposes only.

**CONTRAINDICATIONS**

- Do not use in indications other than the indications mentioned in the DFU or Labeling.

**How to read the catalogue**

The diagram illustrates the layout of a catalogue page for ENT instrumentation. It features a green header with the text 'Diagnosis' and the 'INTEGRA' logo. Below the header, there are five circular icons representing different instrument types: 'Marquet', 'Legent', and three others. Below these icons are five full-length images of the instruments. At the bottom, there is an 'Explanatory table' with the following data:

Blunt hook 90°		Blunt hook 45°		Cotton carrier twist end	Angled probe caustic holder
MCO805	MCO805A	MCO807	MCO807	7719-2	7731
2mm	2,5mm	0,8mm	1mm	120mm	120mm
				Ø 1,2mm	working length 80mm

Labels in the diagram point to: 'Title and/or product family' (the header), 'Detail view of the instrument' (the circular icons), 'Instrument to a 1/1 scale except mentioned otherwise' (the full-length images), and 'Explanatory table see below' (the table at the bottom).

**Explanation of the table reference and complementary product description**

Title or subtitles	
global complementary description	
Product Ref.1	complementary description1
Product Ref.2	complementary description2

Electrode cautery



Eustachian catheter probe



Spring speculum, screws speculum

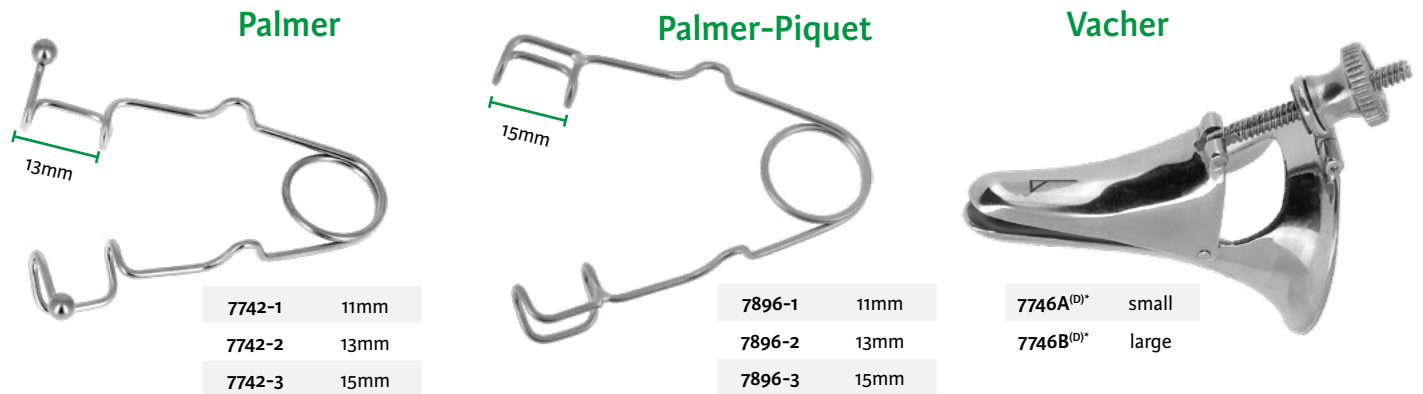

Air bag



<sup>(D)</sup> Distributed by Integra MicroFrance SAS (France) - For corresponding manufacturer part numbers, see table in annex  
\*Please check with your sales representative availability of this product in your country

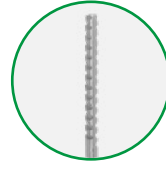
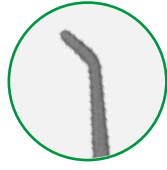

**Marquet**

**Legent**



**MCO950**  
0.8mm



**MCO807**  
1mm



**7719-2**  
Ø 1.2mm



**7731**  
working length 80mm

Blunt hook  
90°

165mm

**MCO805**  
2mm

**MCO805A**  
2.5mm

Blunt hook  
45°

165mm

Cotton carrier, twist end  
15mm

140mm

Angled probe caustic  
holder

110mm

**Hartmann**



160mm  
7898

**Tieck-Halle**



130mm  
7897

**Beckman**



140mm  
7899  
Left hand

**Vienna**



140mm  
MCO233  
Dilatator



140mm  
MCO237  
Self-retaining  
Serrated blades



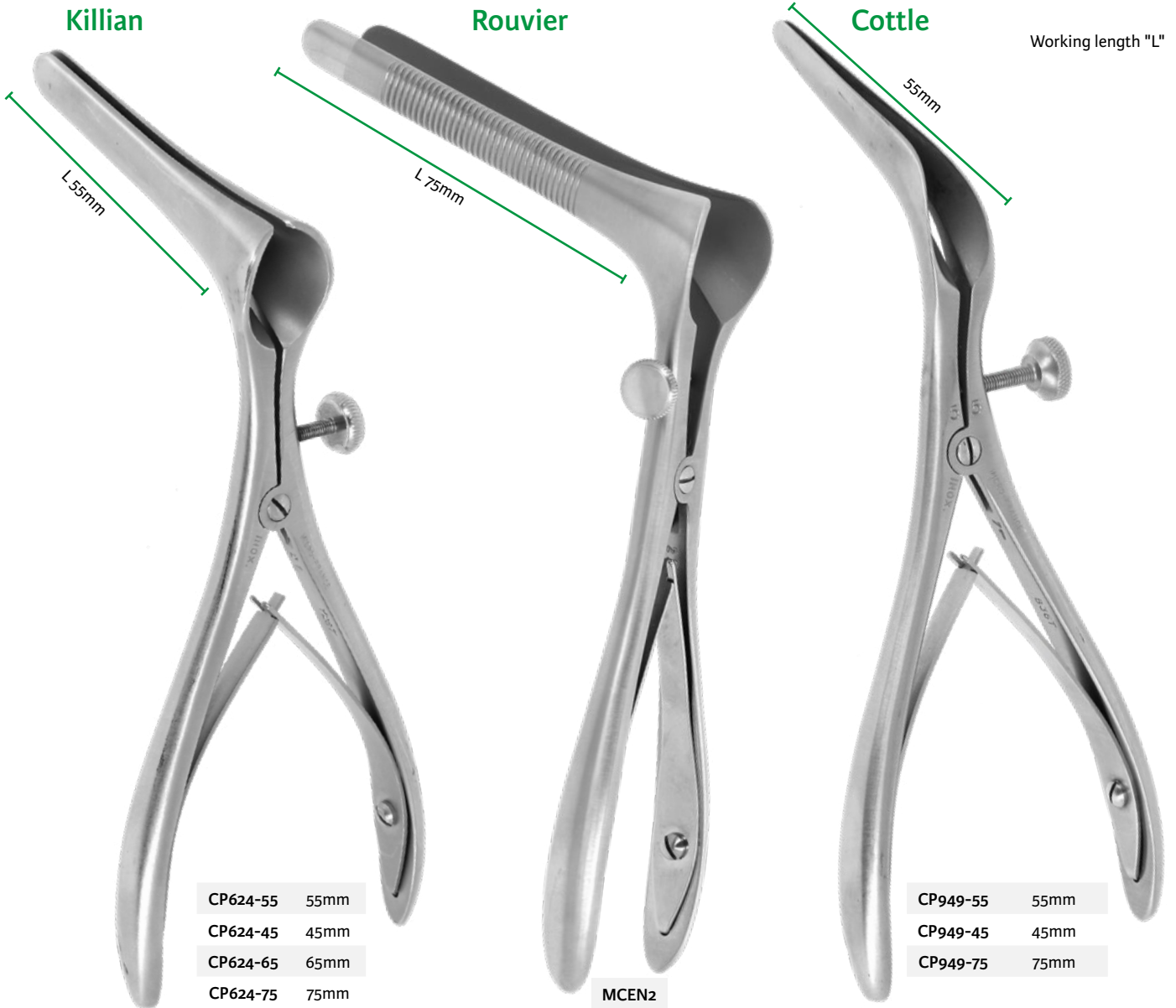

**Self-retaining speculum with fiber optic - Fiberoptic 220cm - Adapters**



Adapters	for generator	for instrument
<b>Wolf</b>	MCL170 <sup>(D)(*)</sup>	MCL171 <sup>(D)(*)</sup>
<b>Storz</b>	MCL173 <sup>(D)(*)</sup>	MCL174 <sup>(D)(*)</sup>
<b>Olympus</b>	MCL197 <sup>(D)(*)</sup>	

<sup>(f)</sup> Not a medical device

<sup>(D)</sup> Distributed by Integra MicroFrance SAS (France) - For corresponding manufacturer part numbers, see table in annex  
\*Please check with your sales representative availability of this product in your country

**Flexible tension arm**

**Legent**



Complete flexible tension arm

**MCO980**

Delivered with MCO981



**Darrouzet**

Complete flexible tension arm

**MCO978**

Delivered with MCO978S

**Operating room table clamp**

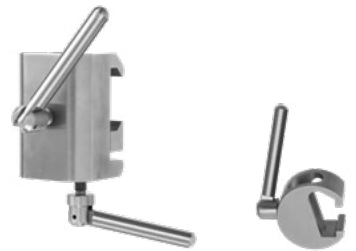

**CEV984**

**CEV985**

**Accessories for flexible tension arm**

Ear quick-lock speculum

Articulated kneecap

Self-retaining specula



**MCO981**



**MCO983-4**



**Devèze**

**MCO981D**



**MCO978S**

Lucae



7726MF

Politzer



7732-1

150mm

7726MF	7727	7728
serrated jaws 1x12mm	spoon jaws	with teeth

120mm

7732-1	7733	7734
serrated jaws 1,5x14mm	spoon jaws	with teeth

Angled forceps

Scale 1/2

Serrated jaws

**Rouvier**

**Pradès**



MCEN18

MCEN19

3x8mm

0.9x7mm

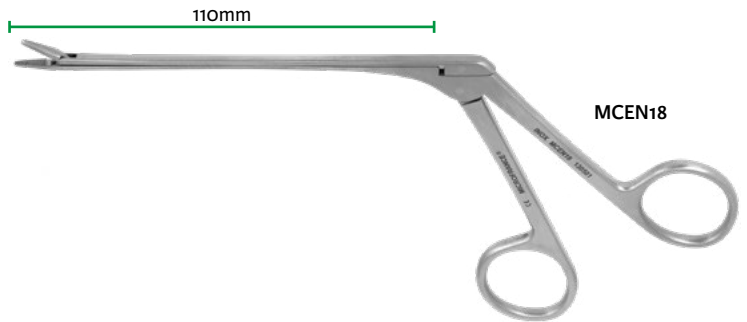

MCEN18

Lubet-Barbon

Jaws 60mm

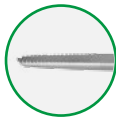
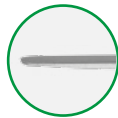

7749

7750

smooth jaws

serrated jaws

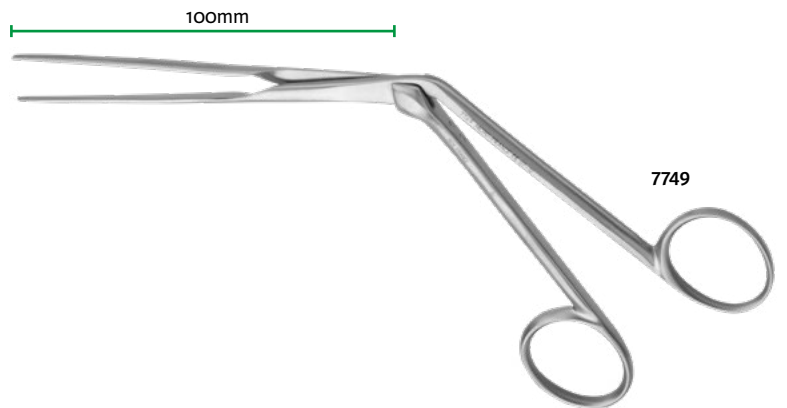

7749

Spoon jaws forceps

**Brünings**

Spoon jaws

Fenestrated spoon jaws



7761-1

7761-2

7761B-1

7761B-2

7.5mm

9.5mm

7.5mm

9.5mm

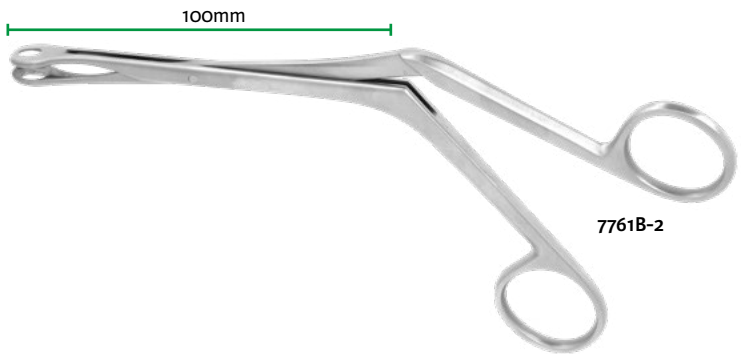

7761B-2

**Luc**

Spoon jaws

Fenestrated spoon jaws

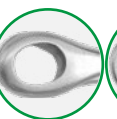

7761C1

7761C2

7761C3

7761BC1

7761BC2

7761BC3

7mm

9mm

11mm

7mm

9mm

11mm

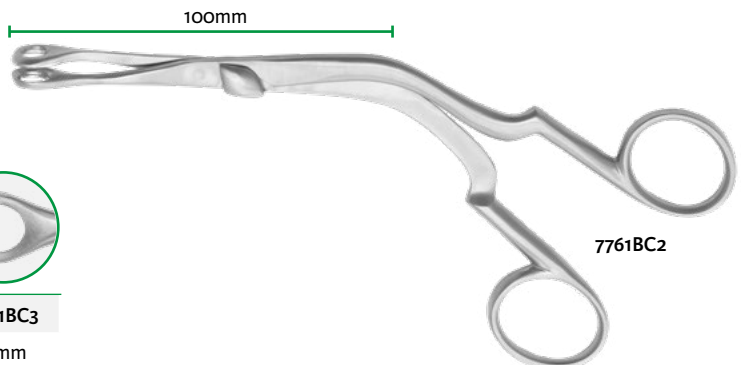

7761BC2

Syringe

Génia



7779MF-5CC

Syringe high pressure  
luer-lock 5cc

Grey washer luer



7779MF-2  
Pack 6

Replacement tube



7779MF-3

White washer piston



7779MF-1  
Pack 6

Sébileau



190mm  
CP985  
5mm

Fleury



180mm  
MCO305  
8,5mm

Freer



185mm  
CP611  
5mm

Howarth



220mm  
CP625

Cottle



220mm  
CP626

McKenty



240mm  
CP627

Rouvier

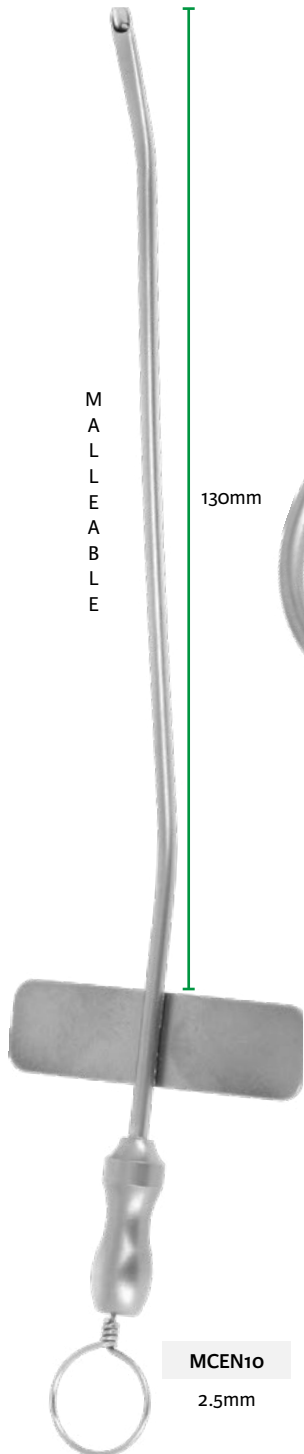

**MCEN10**  
2.5mm

Orsel

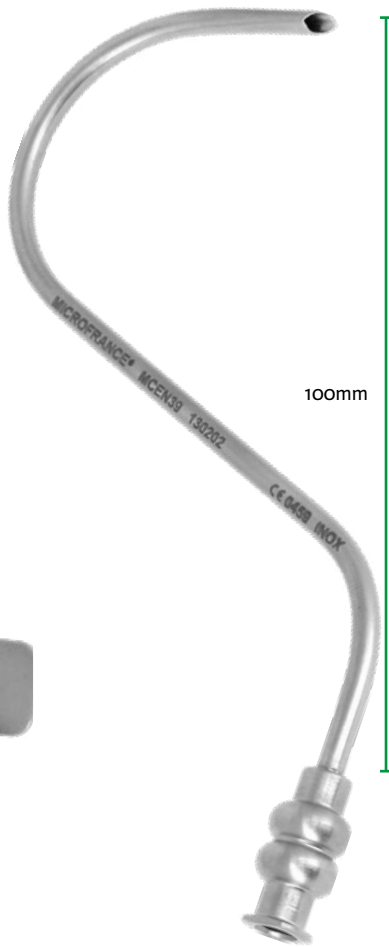

**MCEN39**  
3mm



**MCEN764**  
3.5mm  
sharp



**MCEN765**  
3.5mm  
blunt



Orsel

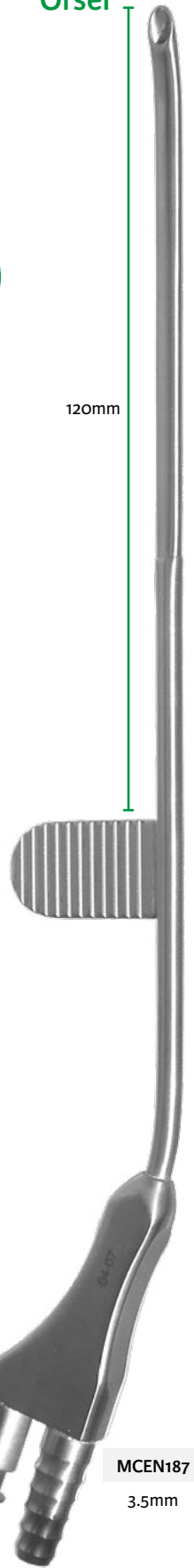

**MCEN187**  
3.5mm  
Irrigation







120mm

1003IG<sup>(D)</sup>\*

N° 3



160mm

1005I<sup>(D)</sup>\*

N° 7



200mm

1003LI<sup>(D)</sup>\*

N° 3L



150mm

CP821



120mm

1004IG<sup>(D)</sup>\*

N° 4

blades 23

use with blades 11/15

<sup>(D)</sup> Distributed by Integra MicroFrance SAS (France) - For corresponding manufacturer part numbers, see table in annex  
\*Please check with your sales representative availability of this product in your country

Ballenger



200mm	
CP622-4	4mm
215mm	
3714164	3mm
3714166	5mm

Joseph



160mm	
CP333	angled

Joseph



160mm	
3714678	
7mm	

Farabeuf

Fleury

Sébileau

Plester



150mm

7787-10

10mm



170mm

MCO979

6,5mm



150mm

CP825

4mm



180mm

MCO988

7,5mm



195mm

3724059

6,5mm

Joseph



180mm

**CP310**

5mm



180mm

**CP310D**

5mm  
Straight



180mm

**CP310E**

4mm

CP310

Obwegeser



Obwegeser

180mm

<b>CP344A</b>	<b>CP344B</b>	<b>CP344C</b>
5mm	7mm	11mm

Obwegeser-Tessier

180mm - sharp

<b>CP344AT</b>	<b>CP344BT</b>	<b>CP344CT</b>
5mm	7mm	11mm

Obwegeser



190mm

<b>CP344D</b>	<b>CP344E</b>
7mm Curved	7mm Very curved

Obwegeser-Tessier

190mm - sharp

<b>CP344DT</b>	<b>CP344ET</b>
7mm Curved	7mm Very curved

CP344A

Farabeuf



140mm	120mm
7768-1	7768
pair	pair

Desmarres



140mm
CP822-12
12mm
CP822-10
10mm
CP822-14
14mm

Gillies



180mm
CP17
3mm
CP17-1
2mm

Gillies



145mm
CP17-3
2mm
CP17-2
3mm



145mm
CP628
5mm

Humby



110mm
CP941
articulated

Kleinert-Kutz



160mm

- 3714024 3mm
- 3714025 5mm
- 3714026 7mm

Cottle



145mm

- 3714107 4mm
- very curved
- 3714108 4mm
- 3714109 5mm

Sisson



150mm

- 3714111 6mm

Converse



180mm

- 3714364 2,5mm

Frazier



130mm

- 3724256 3,5mm

**Knapp**



150mm

3714027

8mm

3714028

blunt



140mm

CP21-3

sharp

CP21A-3

blunt

**Volkmann**



150mm

7782-1-2



180mm

CP335



160mm

CP609

3 sharp prongs



80mm  
CP340

**Claoué**



110mm  
CP341

**Converse**



95mm  
CP331 CP331-1  
sharp blunt

**Kilner**



125mm  
CP803

**Jost**

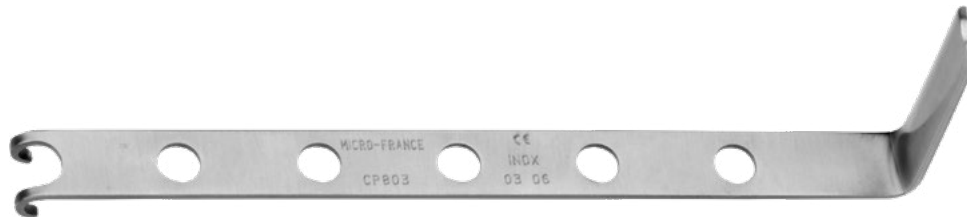

120mm  
CP338



130mm  
CP339



Aufricht



170mm  
CP306 45mm

Cottle



130mm  
3714187

Cottle



130mm  
3714182 Right tip sharp,  
left ball tip  
3714183 Left tip sharp,  
right ball tip

Joseph



CP23-4  
4mm



CP23-6  
6mm



CP23-8  
8mm



CP23A-8  
8mm  
mousse



CP23-10  
10mm

160mm  
CP23-10  
10mm

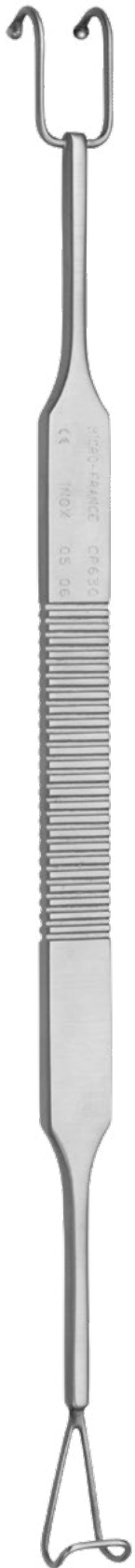

220mm

CP630

with loop  
and ball

Ragnell



160mm

CP632

Dufourmentel



170mm

CP947



Scale 1/1

Straight curette

Volkman



CP302-6

170mm								
0	CP302-2	2mm	0	CP302-4	4mm	0	CP302-6	6mm
0	CP302-3	3mm	0	CP302-5	5mm	0	CP302-8	8mm



165mm - 110g

MCO995

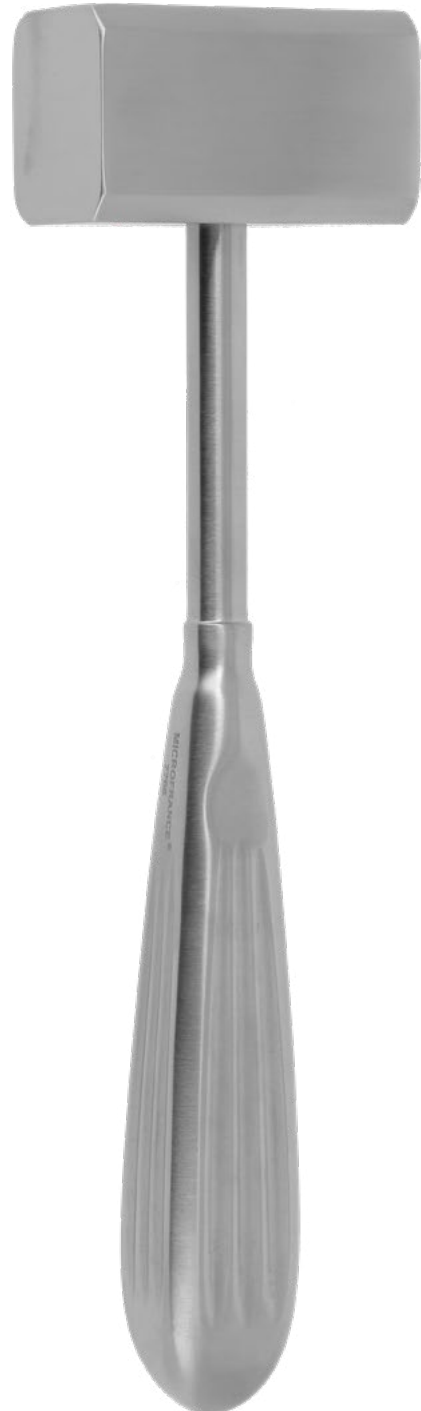

Lombard

185mm - 330g

7766



180mm - 200g

CP907

1 teflon head



180mm - 230g

CP300

Jost

Ballenger

Metzenbaum

Fleury

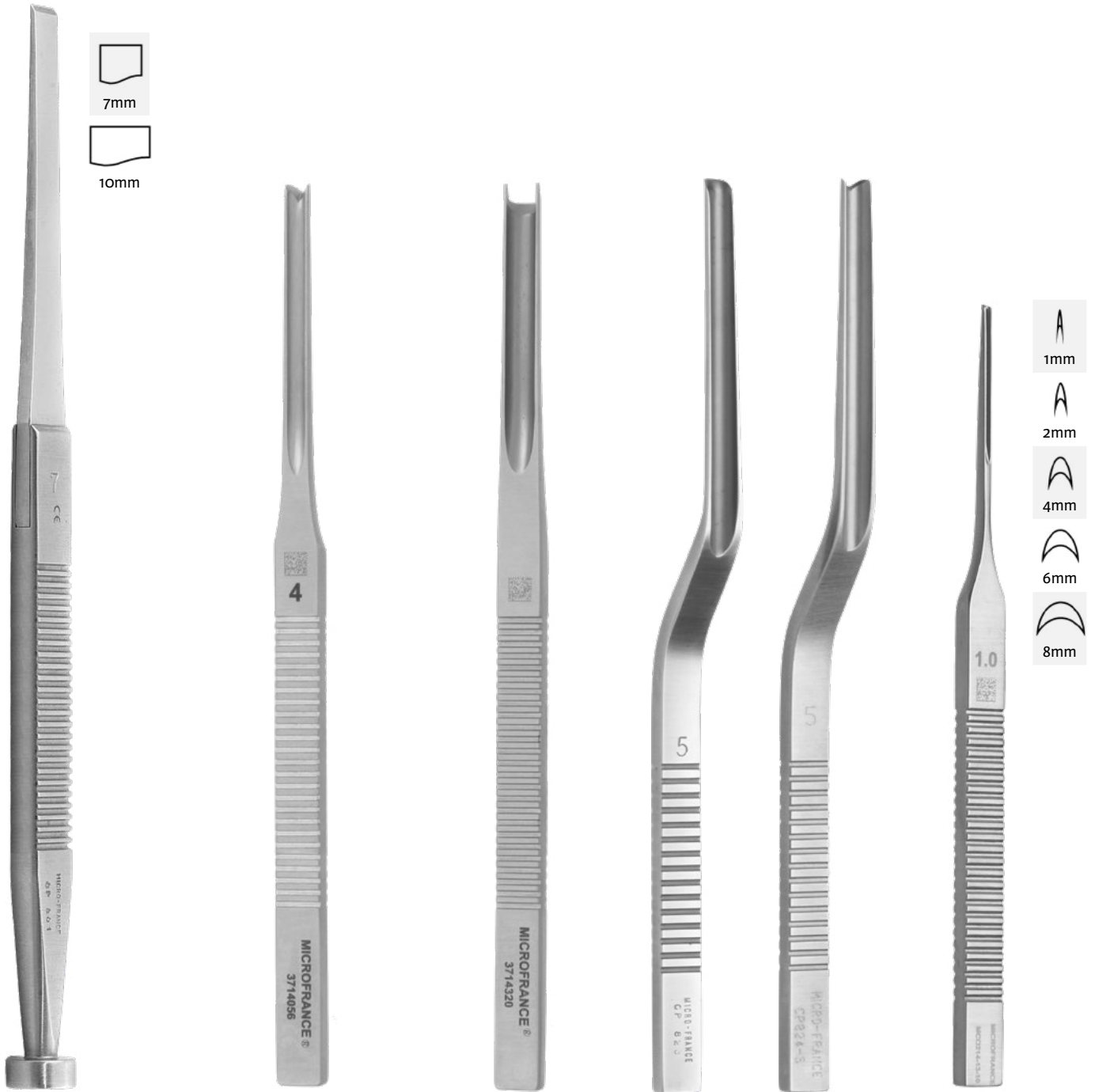

Chisel

Gouge

Straight

Straight 'V' shaped

Bayonet

Bayonet 'V' shaped

Straight

180mm

150mm

150mm

150mm

150mm

130mm

CP801-7	7mm
CP801-10	10mm

3714055	2mm
3714056	4mm
3714057	6mm
3714058	8mm

3714320	5mm
---------	-----

CP823-5	5mm
---------	-----

CP824-5	5mm
---------	-----

MCO214-13-10	1mm
MCO214-13-20	2mm
MCO214-13-40	4mm
MCO214-13-60	6mm
MCO214-13-80	8mm



**Aiach**



160mm  
CP317  
16mm

**Pollet-Pech**



160mm  
CP318  
13mm

**Marchac**



180mm  
CP304-10

Size	Curved	Straight
 2mm	CP304B-2	CP304-2
 3mm	CP304B-3	CP304-3
 4mm	CP304B-4	CP304-4
 5mm	CP304B-5	CP304-5
 6mm	CP304B-6	CP304-6
 7mm	-	CP304-7
 8mm	CP304B-8	CP304-8
 9mm	-	CP304-9
 10mm	CP304B-10	CP304-10
 11mm	-	CP304-11
 12mm	CP304B-12	CP304-12
 14mm	-	CP304-14
 15mm	-	CP304-15
 16mm	-	CP304-16

Tessier

Jost

Marchac

Claoué

Silver



180mm

CP316



180mm

CP802



180mm

CP315

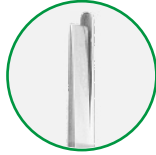

CP315

Pech-Marchac



CP315D

curved right



CP315G

curved left



180mm

CP305



CP305

Lindas

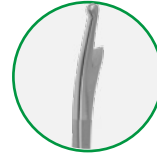

CP305L

curved left

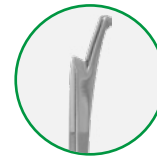

CP305R

curved right



180mm

3714098



3714098

curved right



3714099

curved left

### Mac-Indoe



180mm  
CP314-14  
14mm

### Robin



160mm  
CP309-14-16

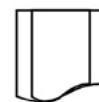

CP309-8-12  
8 - 12mm



CP309-10-14  
10 - 14mm

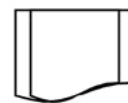

CP309-12-16  
12 - 16mm



CP309-14-16  
14 - 16mm



CP309-14-18  
14 - 18mm

**Cottle**



195mm  
CP808-6  
6mm

**Cottle**



195mm  
CP806  
6mm

**Cottle**



190mm  
CP807  
5mm

**Becker**



200mm  
CP313



200mm  
CP313  
2,5mm

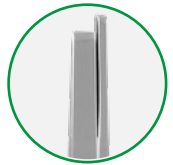

200mm  
CP313-1  
3mm

## Parkès



170mm

3714096

4mm

**Maltz**



170mm  
CP301-1

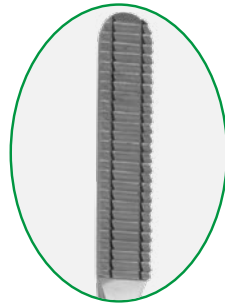

**Maltz**

CP301-1

8x35mm - downstroke

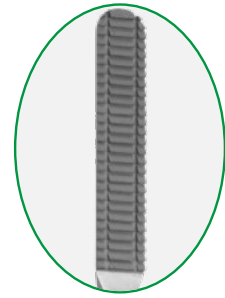

**Maltz**

CP301

10x45mm - downstroke

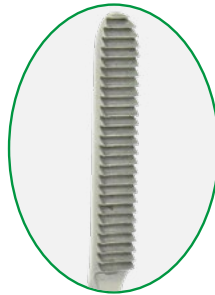

170mm

CP905

8x35mm, downcutting,  
concave

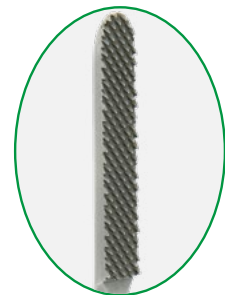

170mm

CP828

8x35mm - downstroke



170mm

CP978

8x35mm, straight, coarse

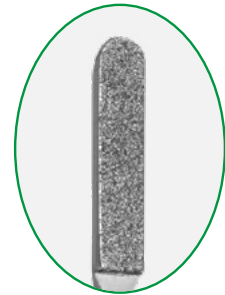

180mm

CP810

8x30mm, straight, diamond

Aufricht

200mm



CP973

8x25mm  
downward  
cutting



CP974

8x25mm  
upward cutting

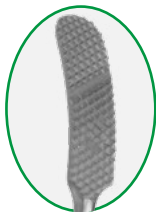

CP976

8x30mm  
bi-directional



200mm

CP1100

8x8mm

Bigot



200mm

CP291

4x15mm

Bigot



190mm

CP998-1

8x12mm  
cross-cutting

Fomon



180mm

CP809

8x30mm  
diamond



175mm

CP301-3

7x20mm  
concave  
downward  
cutting



180mm

CP301-2

8x30mm  
downward cutting

Becker

Becker

Fomon

Rees

Gorney

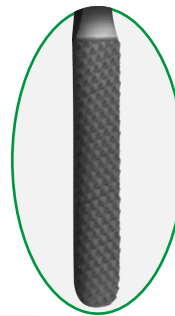

**CP301-10**  
7x38mm-7/8  
Sure-Grip™  
tungsten

**CP1104**  
7x20mm-1/2  
Sure-Grip™  
tungsten

**CP1105**  
7x20mm-3/4  
Sure-Grip™  
tungsten

**CP301-4**  
7x38mm  
coarse

**CP301-5**  
7x38mm  
coarse

**CP301-9**  
7x12mm  
8x22mm



### Fomon



210mm

Double-ended  
one convex  
one flat  
coarse teeth

3714149 7mm

fine teeth

3714148 7mm

3714149

### Aquaplast™ nasal splint

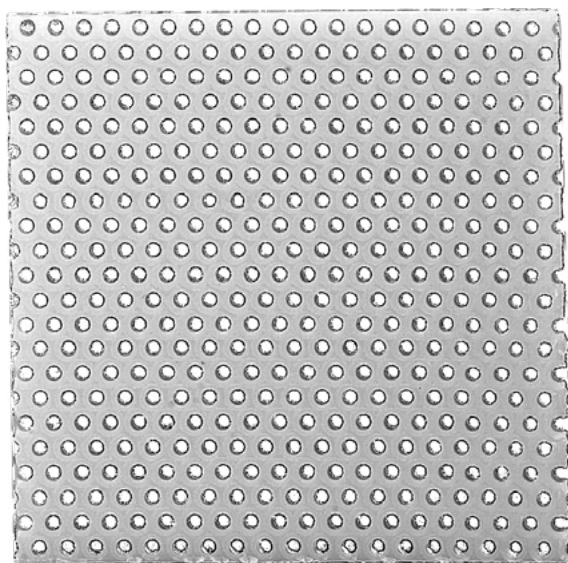

**AQ1728<sup>(D)</sup>\***

75x75mm - Pack 10  
not sterile, single use

---

### Cartilage template

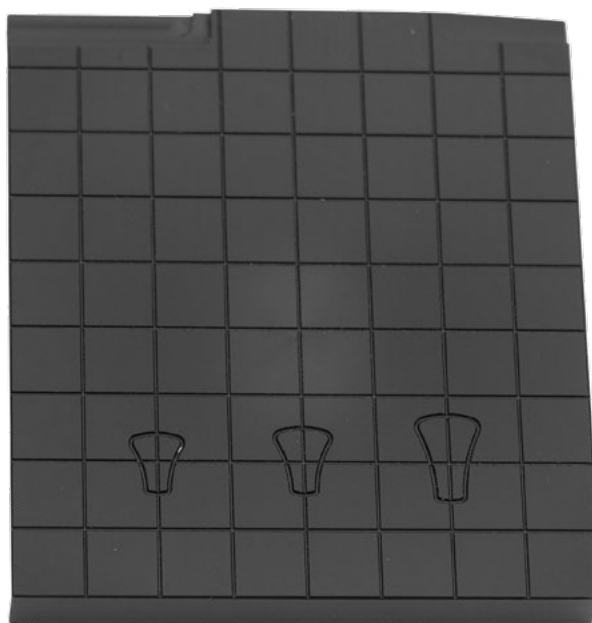

**CP1109**

80x90mm  
with graduations

<sup>(D)</sup> Distributed by Integra MicroFrance SAS (France). For corresponding manufacturer part numbers, see table in annex  
\*Please check with your sales representative availability of this product in your country

Scale 1/2

Cartilage crushing press

Jost



CP814-1

Delivered with key CP814-3



CP814-2

Smooth plate device 30x50mm  
for CP814-1



CP814-3

Tightening key  
for CP814-1

Scale 1/2

Perforator bone forceps

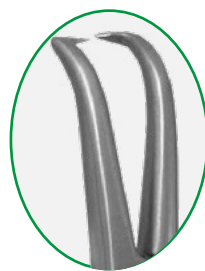

Stoll



150mm

CP640

Scale 1/2



**Beyer**



CP380

160mm

CP380	CP380-2
straight jaws 2mm	curved jaws 2mm

**Beyer**



CP380-3

180mm

CP380-3	CP380-5	CP380-1
curved jaws 2mm	curved jaws 4mm	straight jaws 2mm

## Jansen-Middleton



180mm

Double-action rongeur

CP621 4x20mm

Scale 2/3

Double-action bone rongeur

Ruskin



160mm

CP381

Scale 2/3

## Martin



240mm

7765

Delivered with 2 jaws



Offret

Scale 3/4



100mm

CP353

strong curvature



100mm

CP356

Streiff

Joseph

Fox



CP16-1

105mm

CP16-1

CP16

Curved blades

Straight blades



CP919A

110mm

CP919A

CP919

Curved blades

Straight blades



CP358A

110mm

CP358A

CP358

Curved blades

Straight blades

Joseph

Kilner-jost



CP354A

120mm - matt finish

CP354A	CP354
Curved blades	Straight blades



120mm - matt finish

CP362
Curved

Boetcher

Brophy

Joseph



180mm

CP997

Curved



CP367-1

150mm

CP367-1

Curved

CP367

Straight

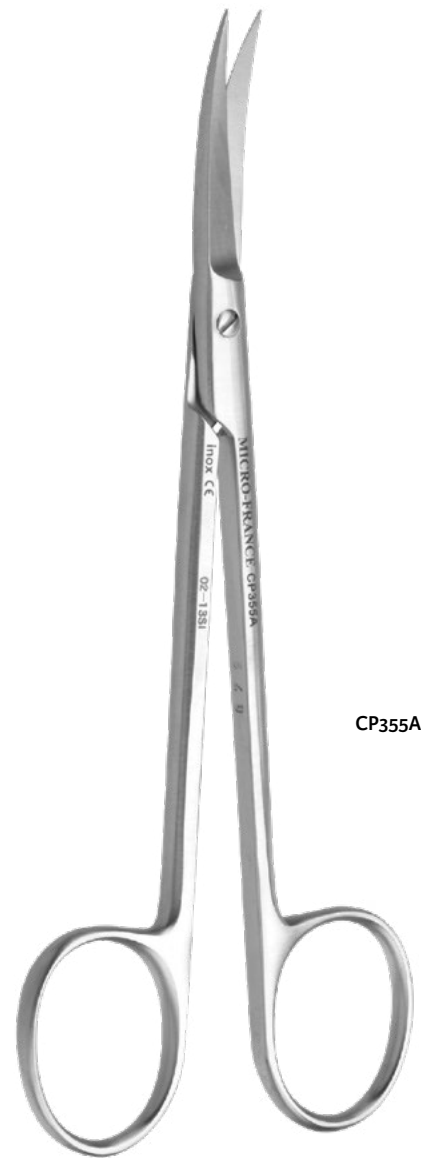

CP355A

150mm

CP355A

Curved

CP355

Straight

Bregat

Stevens

Stevens



110mm

CP363

Curved blades



110mm - Tenotomy scissors

CP922

Straight blades



110mm - Tenotomy scissors

CP922A

Curved blades

## Stevens

## Shea

matt finish

matt finish



115mm - Tenotomy scissors

CP922B

Curved blades



120mm

CP637

Curved blades

Reynolds

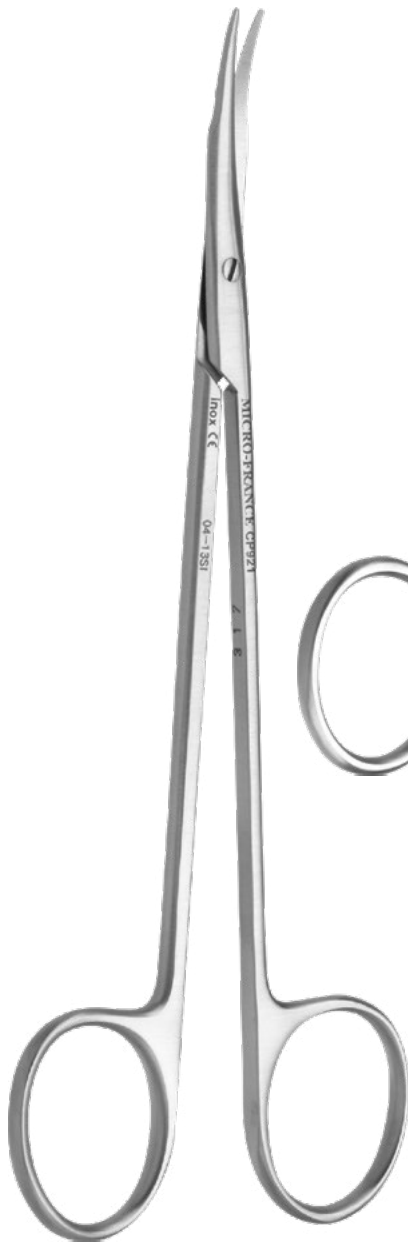

160mm

CP921

Ragnell



150mm

CP616-15



130mm

CP616-13

Joseph



150mm

CP355C

Léger



150mm

CP365

**Metzenbaum**

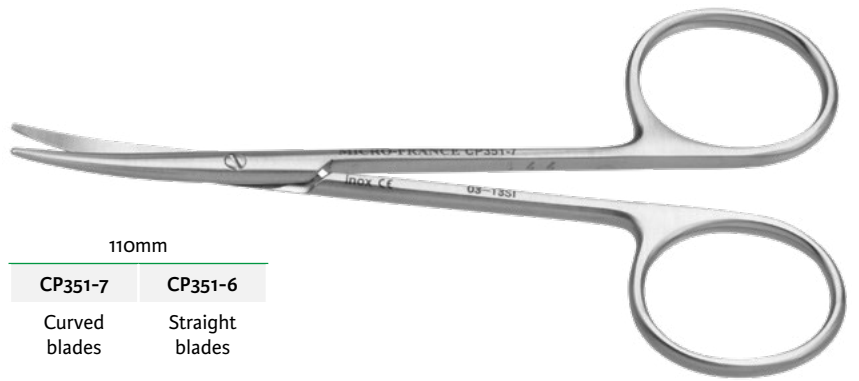

110mm

<b>CP351-7</b>	<b>CP351-6</b>
Curved blades	Straight blades

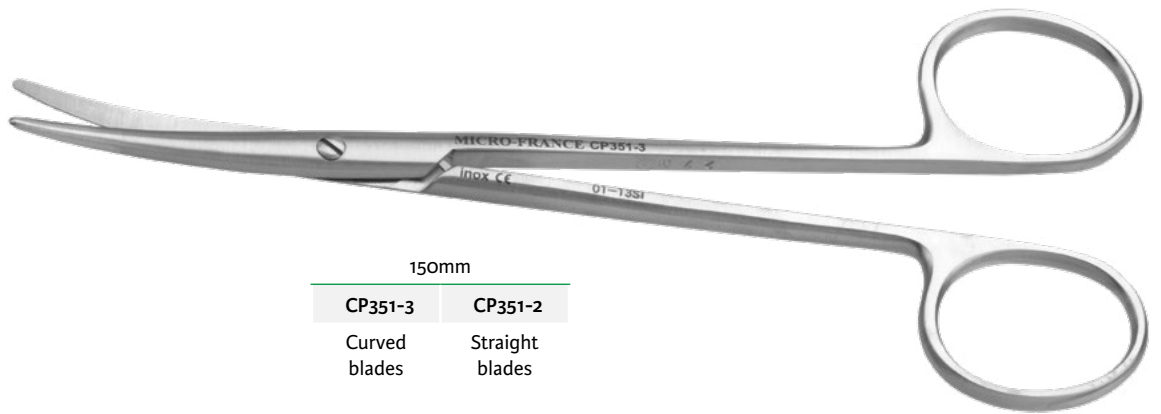

150mm

<b>CP351-3</b>	<b>CP351-2</b>
Curved blades	Straight blades

**Delicate curved scissors**

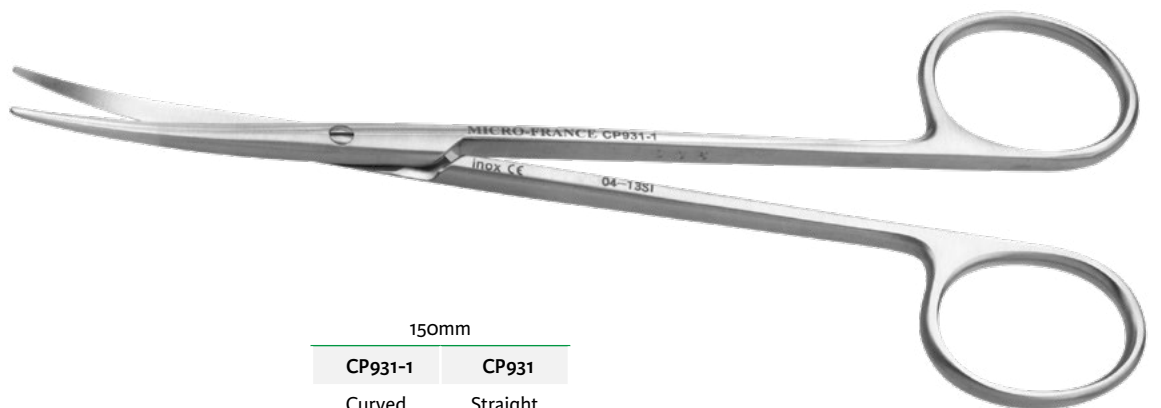

150mm

<b>CP931-1</b>	<b>CP931</b>
Curved blades	Straight blades

Mayo



170mm

CP352-2

Straight blades

150mm

CP352

Straight blades

150mm

CP352-1

Curved blades

170mm

CP352-3

Curved blades



**Becker-Converte**

100mm  
CP1106  
Angled scissors  
serrated blades



**Converte**

100mm  
CP348  
Angled scissors



**Fomon**

**Fomon**



140mm  
CP612  
lower lateral scissors  
very curved

**Cottle**

**Pellegrini**

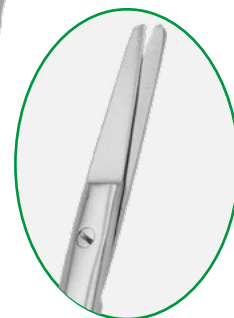

150mm  
CP359  
dorsal scissors  
serrated blades

**Cottle-Pech**

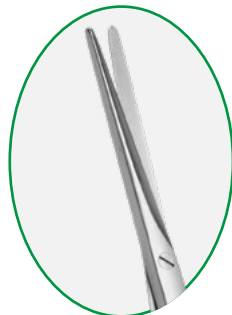

140mm  
CP635  
dorsal scissors



140mm  
CP613  
dorsal scissors - blunt tip



150mm  
CP614  
dorsal scissors

**Heymann-Klossek**

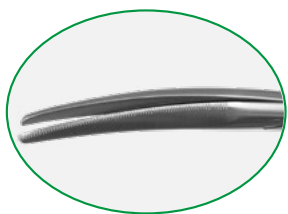
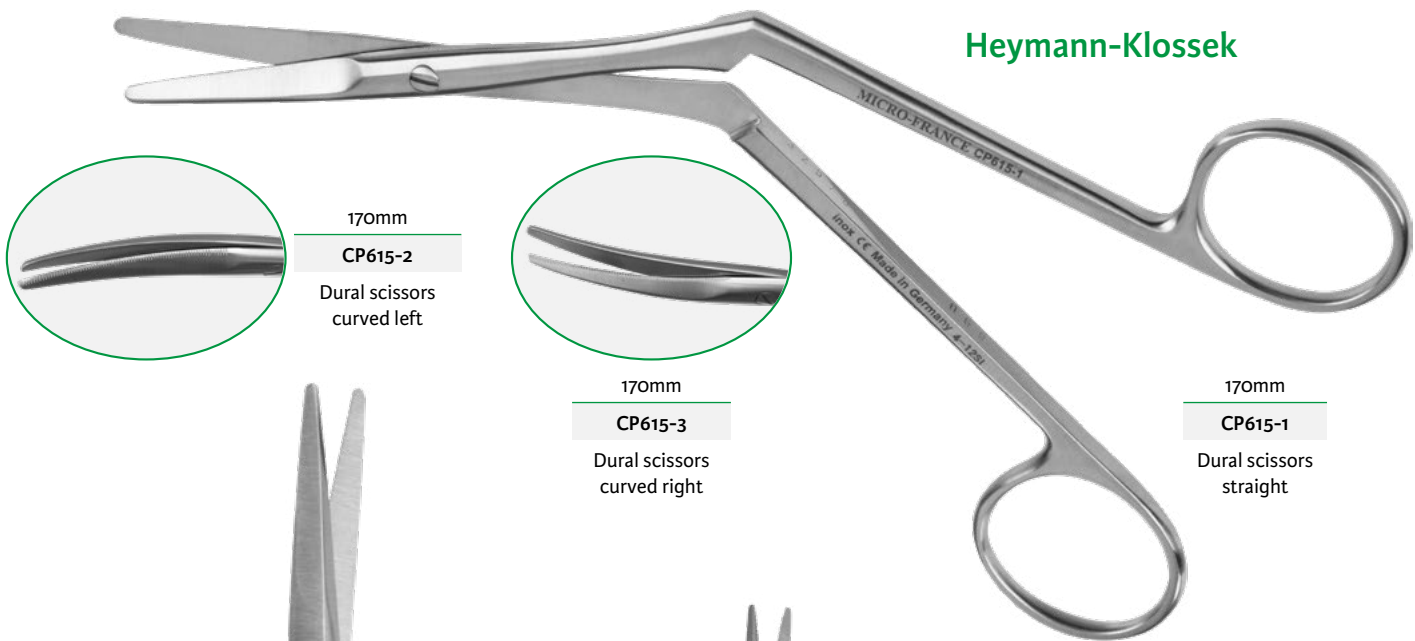

170mm  
**CP615-2**  
Dural scissors curved left



170mm  
**CP615-3**  
Dural scissors curved right

170mm  
**CP615-1**  
Dural scissors straight

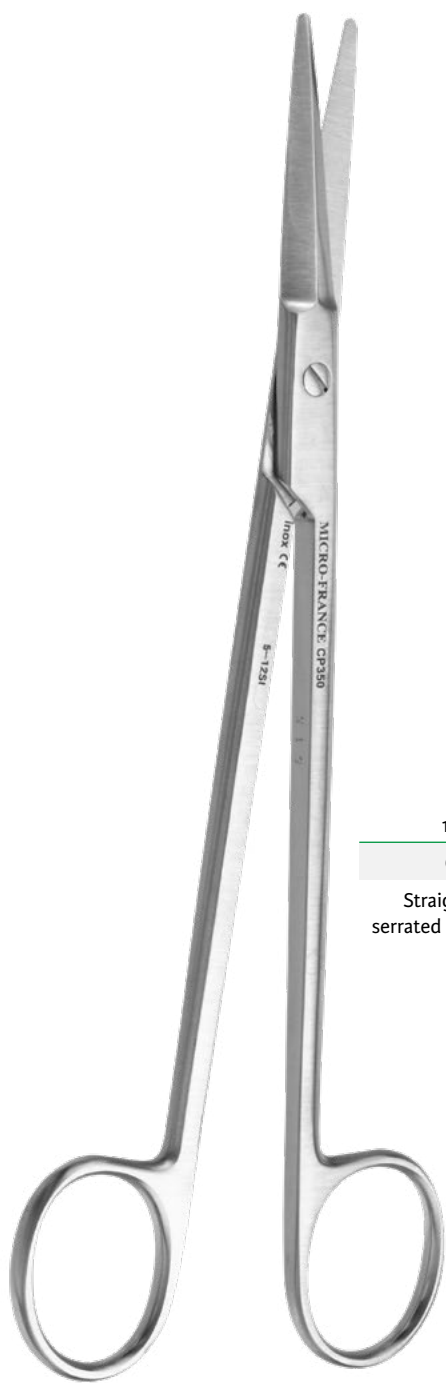

180mm  
**CP350**  
Straight scissors serrated bayonet blades

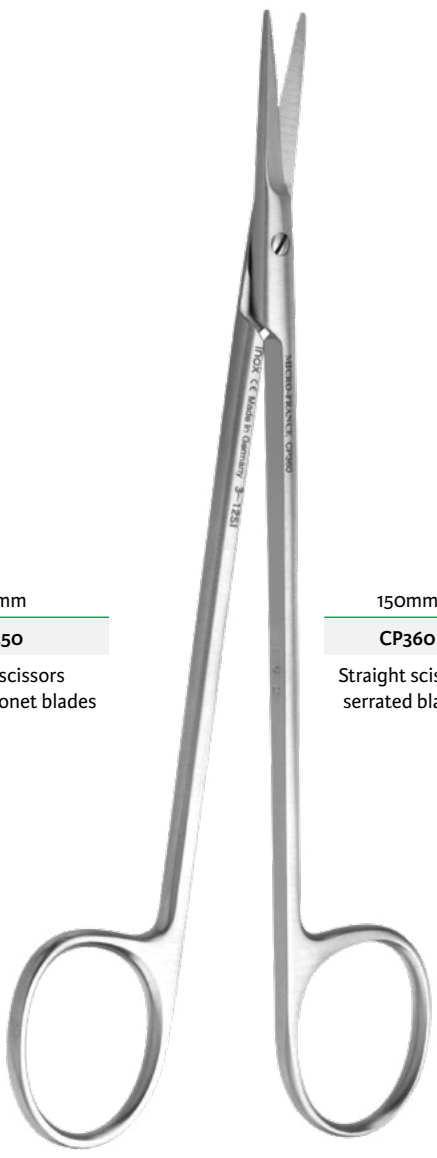

150mm  
**CP360**  
Straight scissors serrated blades

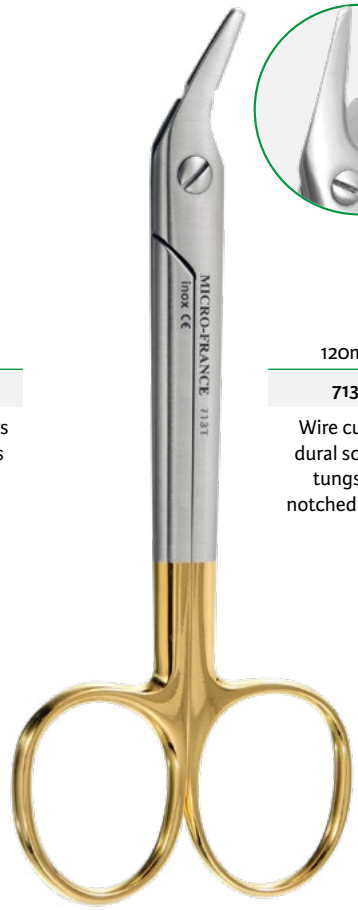

120mm  
**713T**  
Wire cutting dural scissors tungsten notched blades



**Bebee**

Dissecting forceps 110mm

Castroviejo



CP938-1

Horizontal teeth and platform

Castroviejo



CP37

Oblique teeth and platform



CP332

Serrated jaws 1.4mm

Dissecting forceps 120mm



Serrated jaws

CP414  
Jaws 1mm



7831A-12  
Jaws 1.5mm



CP406  
Jaws 1mm



Jaws with teeth

7833A-12  
Jaws 1.5mm



CP400-1  
5X5 teeth

150mm

Adson



CP604-15 Serrated jaws 1.5mm  
CP605-15 1x2 teeth jaws 1.5mm

Adson-Brown



CP606-15 7x7 teeth

120mm



Adson-Tubiana

Jaws 1mm

M832

serrated jaws

M833

1x2 teeth

Adson

Jaws 1,5mm

CP604

serrated jaws

CP605

1x2 teeth

Jaws 1,5mm

CP606A

tungsten serrated jaws

Adson-Brown

Jaws with 7x7 teeth

CP606

**Mac-Indoe**

140mm



**CP934** Oblique teeth and serrated platform

**CP934-1** Serrated jaws

**Debakey**

**Barraya**

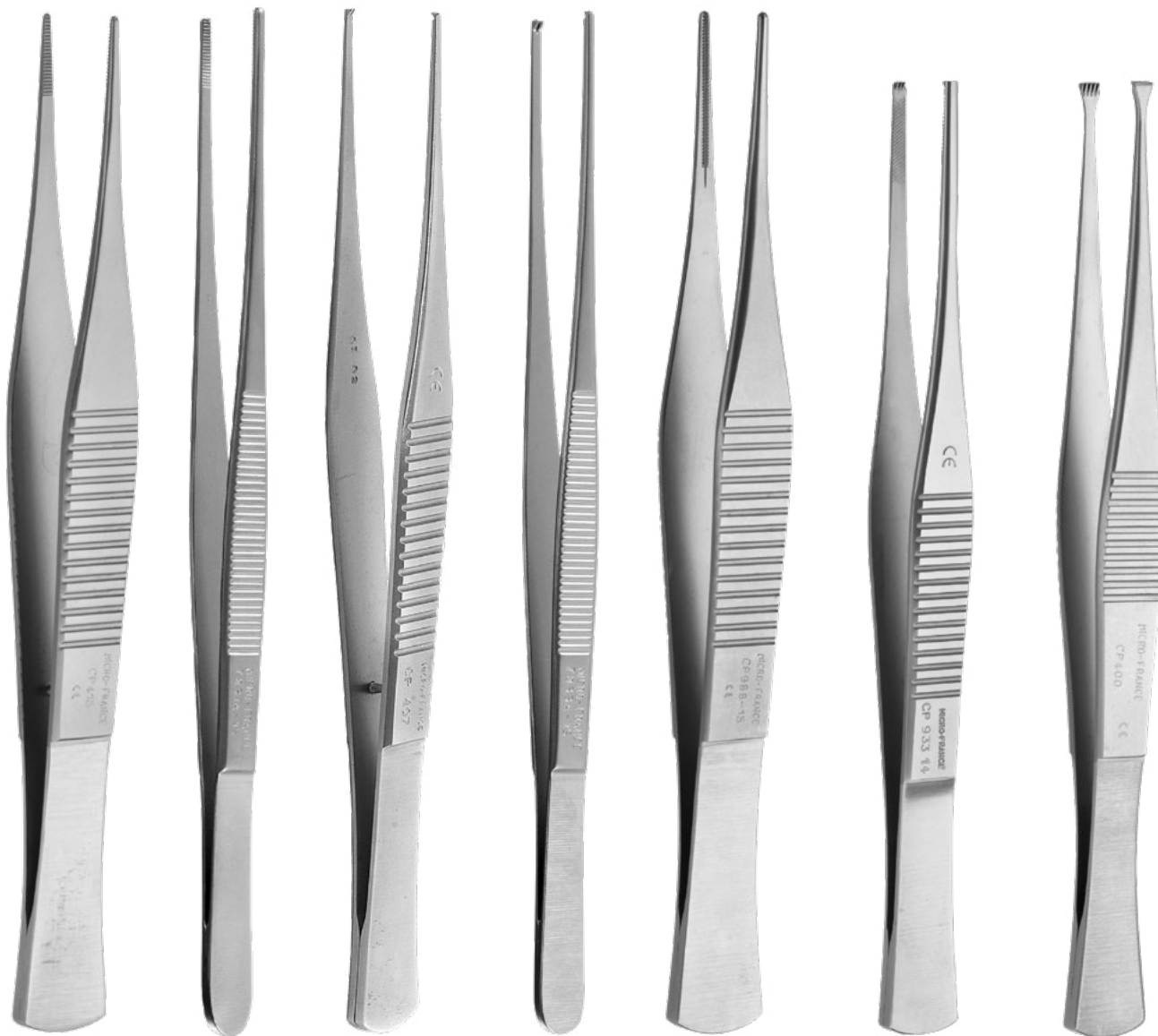

150mm

140mm

<b>CP415</b>	<b>7831A-15</b>	<b>CP407</b>	<b>7833A-15</b>	<b>CP988-15</b>	<b>CP933-14</b>	<b>CP400</b>
Serrated jaws 1mm	Serrated jaws 1.5mm	1x2 teeth jaws 1mm	1x2 teeth jaws 1.5mm	Serrated jaws 1.5mm	3x4 teeth and serrated platform	5x5 teeth

Précelle



150mm

CP345

serrated angled jaws

Barraya



160mm

CP933-16

3x4 teeth and  
serrated platform

Claué



160mm

CP401

5x6 teeth

Mac-Indoe



170mm

CP936

1x2 teeth and  
serrated platform

Debakey



1,5mm  
7831A-18  
serrated jaws



1,5mm  
CP988-18  
serrated jaws



1mm  
CP409  
1x2 teeth

**Barraya**



1,5mm

7833A-18

1x2 teeth



1,5mm

CP933-18

3x4 teeth and serrated platform



6x6 teeth

CP400-2



Debakey



200mm	210mm
7832	7834
1mm	1mm
serrated jaws	1x2 teeth

2mm
7831A-20
serrated jaws

1,5mm
CP988-20
serrated jaws

2mm
7833A-20
1x2 teeth

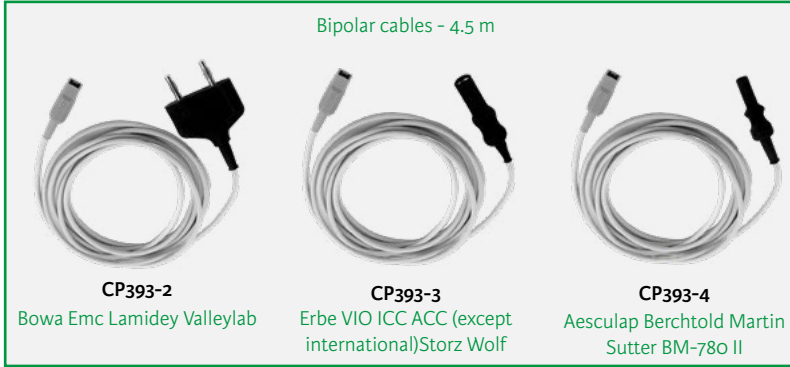

**Magnan**



**Adson**



110mm		120mm		160mm		200mm	
CP392-1R	CP604BR	CP605BR	CP392-2R	CP392-8R	CP392BI	CP392BS	
smooth jaws 1x8mm	serrated jaws 1.5mm	1x2 teeth 1.5mm	smooth jaws 1x8mm	smooth jaws 1x8mm	smooth jaws 0.5x5mm	smooth jaws 0.5x5mm	



**Adson**



110mm

**CP390-1**

Smooth jaws  
1x8mm



120mm

**CP604M**

Serrated jaws  
1.5mm



**CP605M**

1x2 teeth  
1.5mm



160mm

**CP390-2**

Smooth jaws  
1x8mm



**CP390-8**

1x2 teeth  
1x8mm

**Halsey**

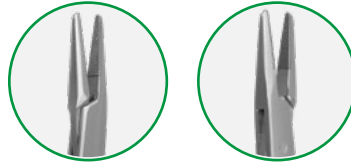

130mm

<b>703T</b>	<b>704T</b>
serrated jaws	Smooth jaws
for needle 4/0 5/0	



703T

**Crile-Wood Mayo-Hégar**

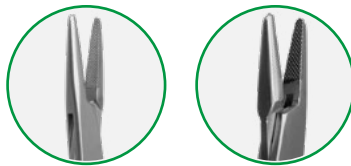

150mm

<b>702T</b>	<b>714T</b>
needle 4/0 5/0 6/0	1/0 2/0 3/0 4/0



702T

**Becker**

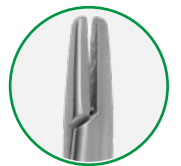

130mm

<b>CP1107</b>
Diamond jaws

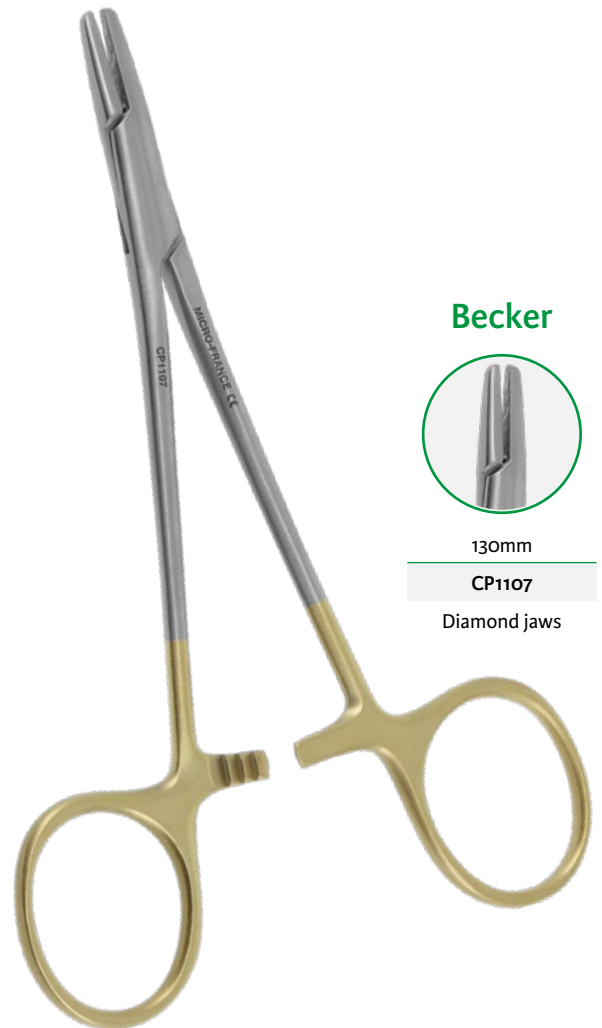



### Leriche

140mm - without teeth

7867-1	7867-2
--------	--------

Straight	Curved
----------	--------

140mm - with teeth

7867-3	7867-4
--------	--------

Straight	Curved
----------	--------

7867-1



### Halsted

120mm - with teeth

P761-7	P761-8
--------	--------

Straight	Curved
----------	--------

P761-7





### Martel

130mm

P763

Forceps with teeth, 'T' tip



### Péan

140mm 160mm

P765-14 P765-16

Haemostatic forceps serrated jaws

P765-14



### Terrier

130mm

P769

Haemostatic forceps serrated jaws



### Chaput

130mm

7866-13

2x3 teeth



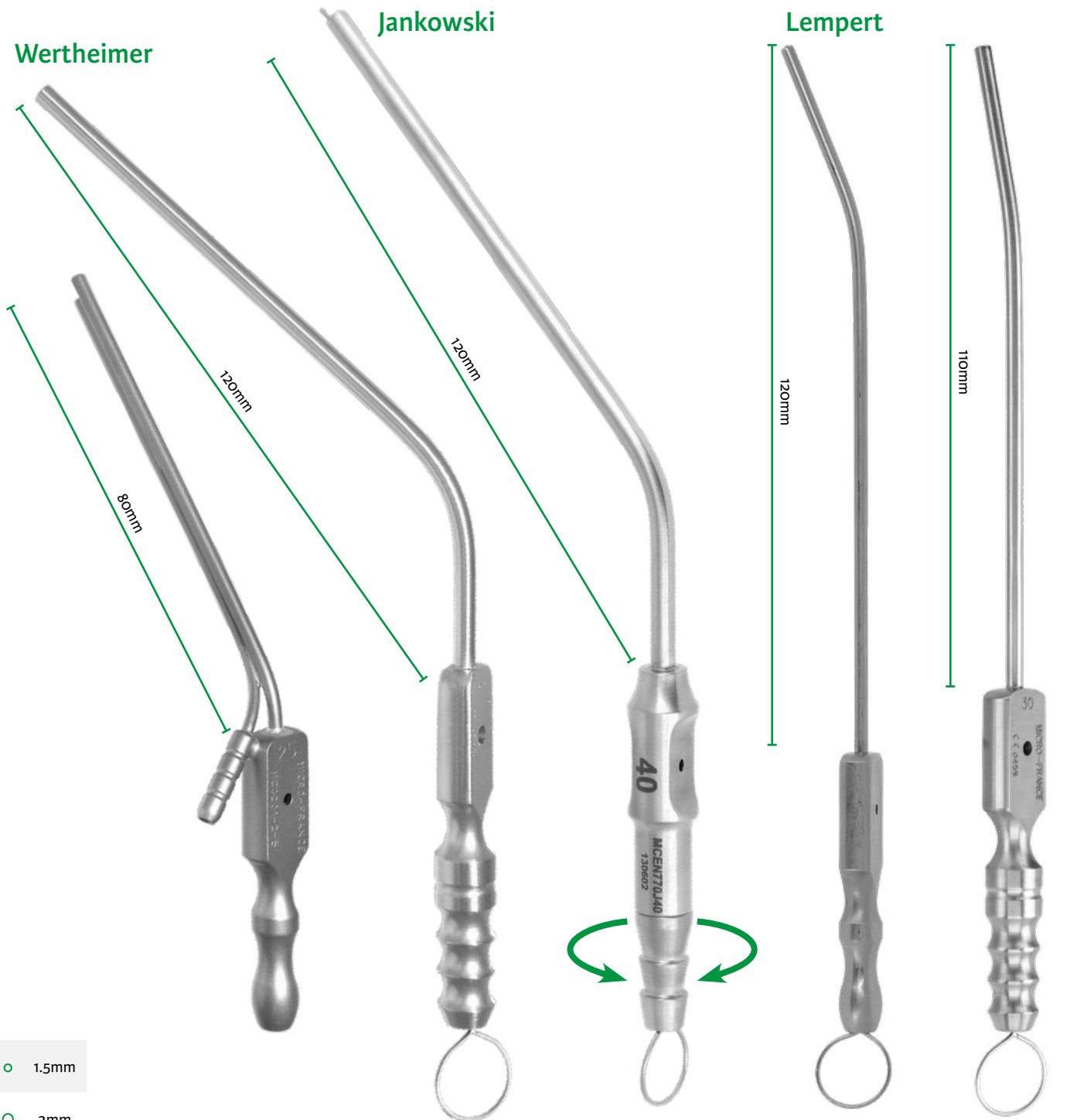

- 1.5mm
- 2mm
- 2.5mm
- 3mm
- 3.5mm
- 4mm

Wertheimer		Jankowski		Lempert			
MCO201-2-5	2.5mm	MCO770-1-5	1.5mm	MCEN770J40	4mm	MCO771-2-5	2.5mm
MCO201-3-0	3mm	MCO770-2-0	2mm	MCEN770J30	3mm	MCO771-3-0	3mm
		MCO770-2-5	2.5mm			MCO771-4-0	4mm
		MCO770-3-0	3mm				
		MCO770-3-5	3.5mm				
		MCO770-4-0	4mm				
						CP330-3-0	3mm
						CP330-4-0	4mm

Luer-lock adapter

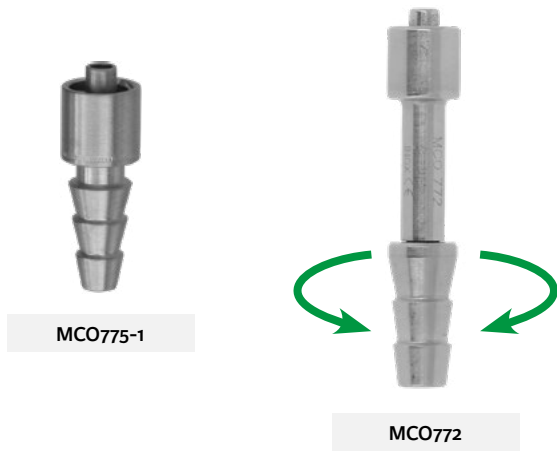

Suction tube adapter with finger control

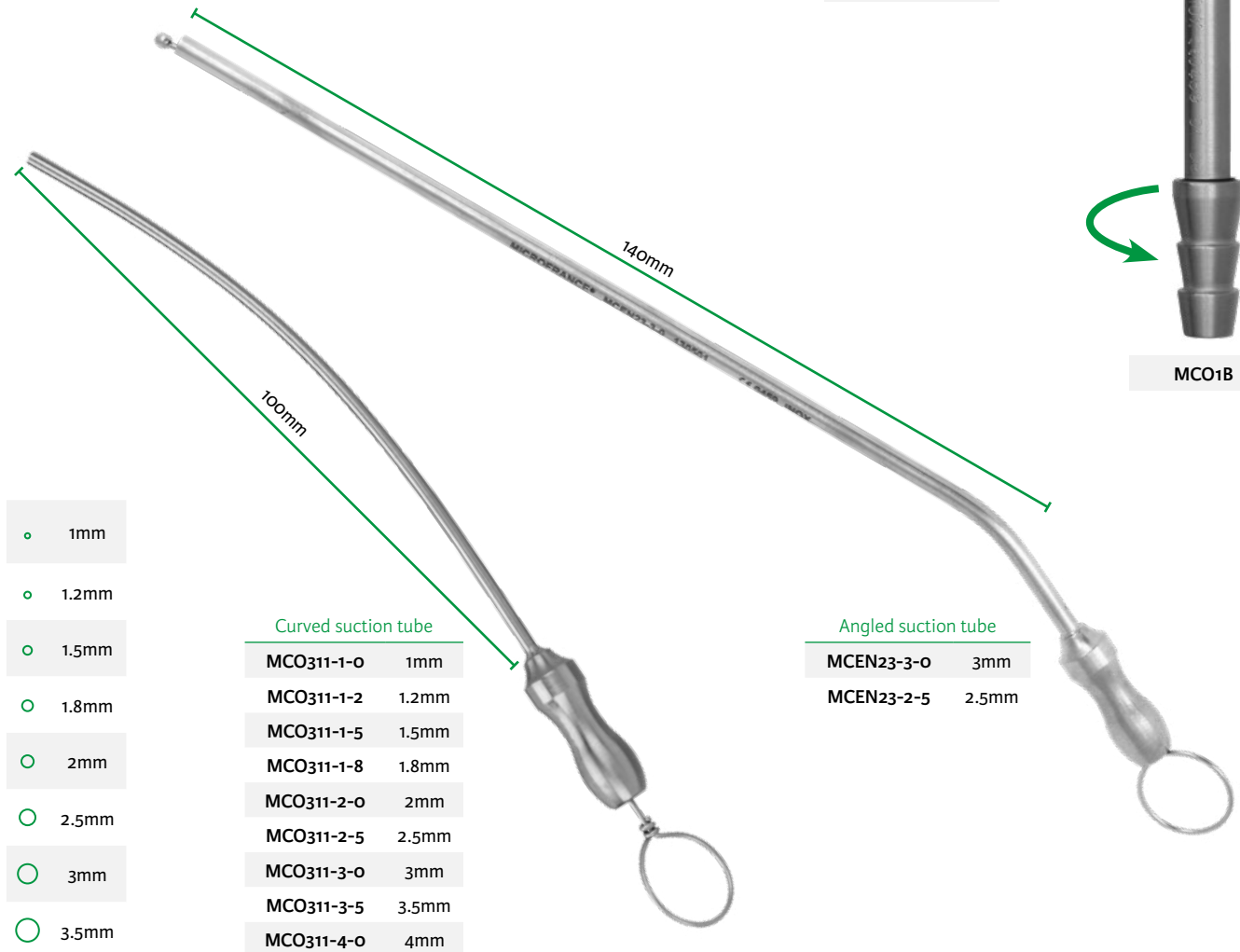

- 1mm
- 1.2mm
- 1.5mm
- 1.8mm
- 2mm
- 2.5mm
- 3mm
- 3.5mm
- 4mm

Curved suction tube

MCO311-1-0	1mm
MCO311-1-2	1.2mm
MCO311-1-5	1.5mm
MCO311-1-8	1.8mm
MCO311-2-0	2mm
MCO311-2-5	2.5mm
MCO311-3-0	3mm
MCO311-3-5	3.5mm
MCO311-4-0	4mm

Angled suction tube

MCEN23-3-0	3mm
MCEN23-2-5	2.5mm

110mm

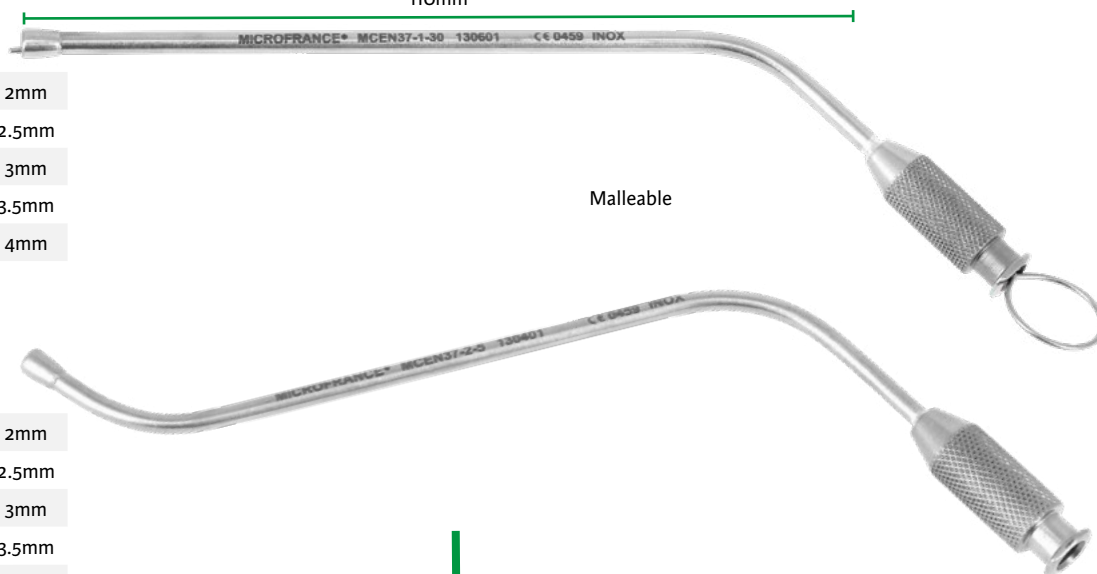

MCEN37-1-20	2mm
MCEN37-1-25	2.5mm
MCEN37-1-30	3mm
MCEN371D35	3.5mm
MCEN371D4	4mm

MCEN37-2-0	2mm
MCEN37-2-5	2.5mm
MCEN37-3-0	3mm
MCEN37-3-5	3.5mm
MCEN37D4	4mm



**De Gabory**

Handle for suction tube  
rotatable connection

MCEN103LDG

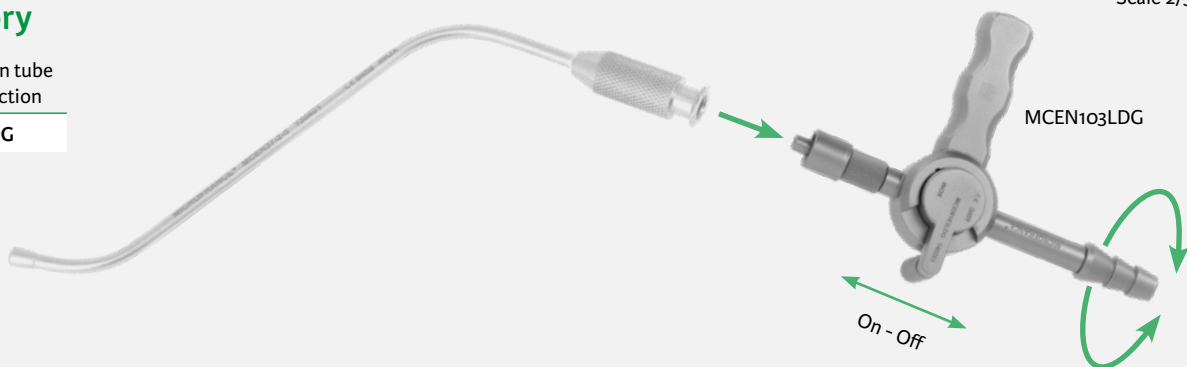

120mm



Blunt suction tube  
with finger control

MCEN770B25	2.5mm
MCEN770B30	3mm



MCEN77-3-0	3mm
MCEN77-3-5	3.5mm

**Jankowski**

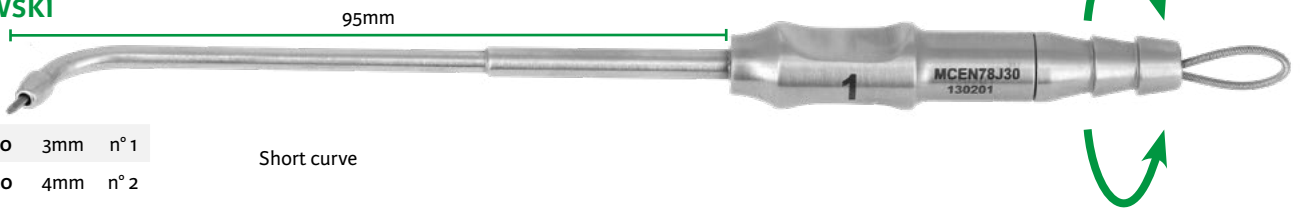

MCEN78J30	3mm	n° 1
MCEN78J40	4mm	n° 2

Short curve

**Jankowski**



Long curve

MCEN79J25	2.5mm	n° 3
MCEN79J30	3mm	n° 4
MCEN79J40	4mm	n° 5

**Orsel**

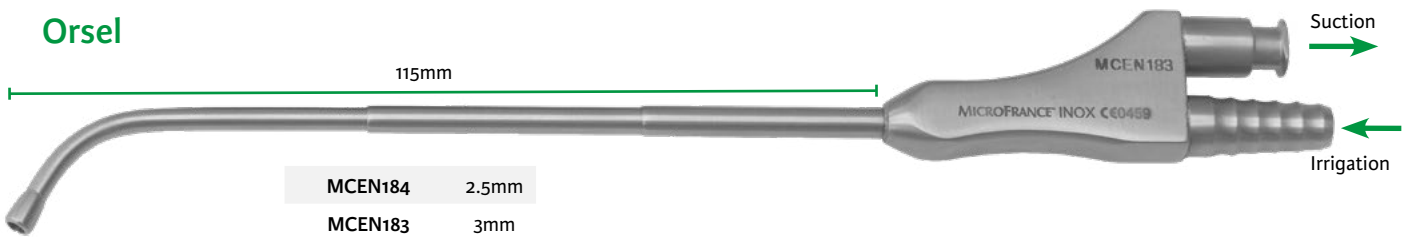

MCEN184	2.5mm
MCEN183	3mm

**Orsel**

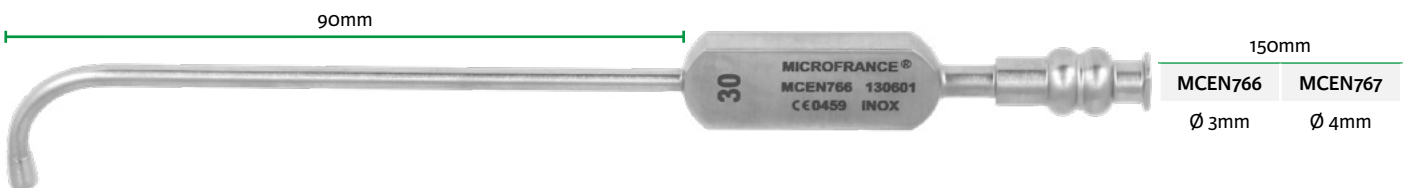

	150mm
MCEN766	MCEN767
Ø 3mm	Ø 4mm

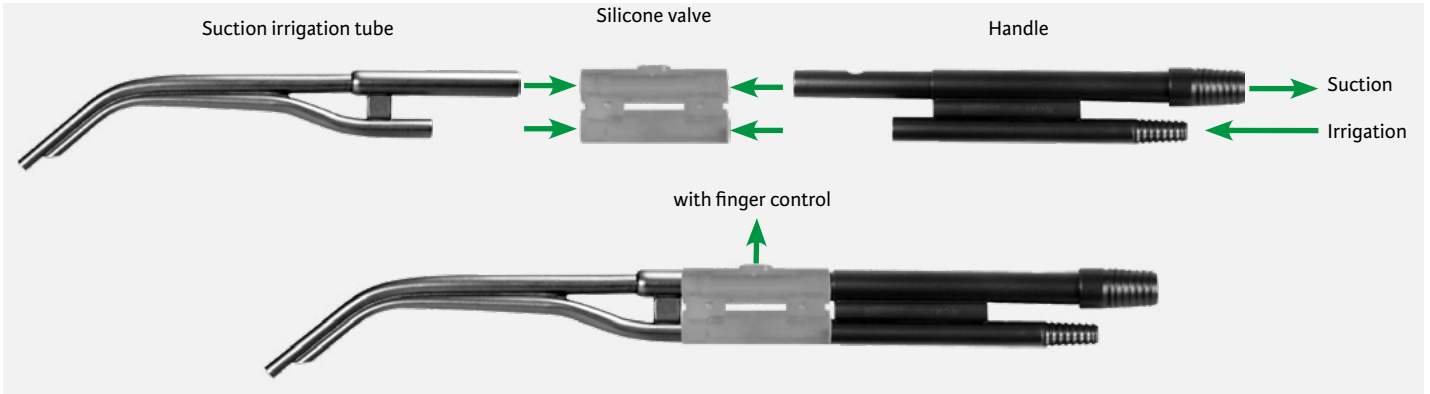

Handle  
Delivered with silicone valve

1375012



Suction irrigation tube without hole

Reference Working length Size fr Size mm

1375020 100mm 10X10 3.3 X 3.3



Suction irrigation tube with hole

Reference Working length Size fr Size mm

1375025 100mm 10X10 3.3 X 3.3

1375101 90mm 5X4 1.7 X 1.4

1375102 90mm 4X4 1.4 X 1.4

1375103 90mm 4X3 1.4 X 1

1375107 90mm 7X7 2.3 X 2.3

1375110 90mm 10X7 3.3 X 2.3

1375114 90mm 14X7 4.7 X 2.3

1375201 120mm 5X4 1.7 X 1.4

1375207 120mm 7X7 2.3 X 2.3

1375210 120mm 10X7 3.3 X 2.3

1375214 120mm 14X14 4.7 X 4.7



1375025



1375101



1375107

Dessi pump accessories



irrigation tubing Sterile,  
disposable  
single use

**MCEN84S<sup>(D)</sup>\***

Pack 20

Used with irrigation pump  
MCEN80\*\*

Scale 2/3

Working length "L"

- 0° MCEN83-C
- 30° MCEN81-C
- 45° MCEN87C
- 70° MCEN82-C

**MCEN82-C**  
L 150mm

**Comeg**



**MCEN81O**  
L 140mm

**Olympus**



L 140mm

L 125mm

	L 140mm	L 125mm			
0°	MCEN83O	MCEN83OL	for scope (WA96200A)	-	-
30°	MCEN81O	MCEN81O1	(WA96201A)	MCEN81O2	for scope (WA96202A)
45°	-	MCEN87O3	(WA96203A)	MCEN87O4	(WA96204A)
70°	MCEN82O	MCEN82O5	(WA96205A)	MCEN82O6	(WA96206A)

- 0° MCEN83-S
- 30° MCEN81-S
- 45° MCEN87-S
- 70° MCEN82-S

**MCEN83-S**  
L 150mm

**Storz**



- 0° MCEN83-W
- 25° MCEN81-W
- 30° MCEN81-W
- 45° MCEN87W
- 70° MCEN82-W

**MCEN83-W**  
L 150mm

**Wolf**



Sleeve for variable scope

**MCEN88SC**

**MCEN88SC**  
L 150mm

**Sopro Comeg**

for scope : pattern :  
Olympus WA9T400V  
Sopro Comeg Ulyss



<sup>(D)</sup> Distributed by Integra MicroFrance SAS (France) - For corresponding manufacturer part numbers, see table in annex  
\*Please check with your sales representative availability of this product in your country  
\*\* Reference discontinued

Scale 2/3

Working length "L"

Trocar and cannula

**Rouvier**

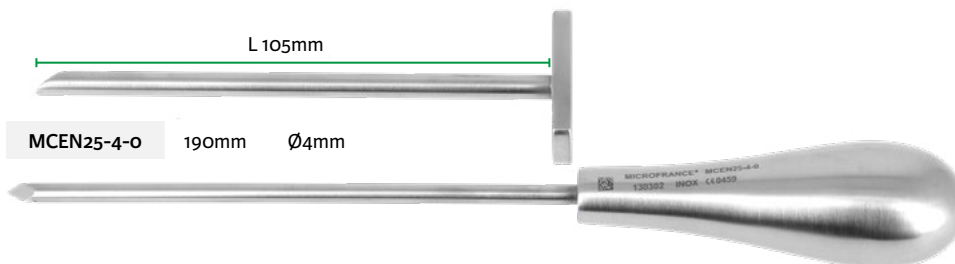

Biopsy cup forceps  
for trocar MCEN25-4-0

**MCEN28**

Double-action jaws  
2x5mm

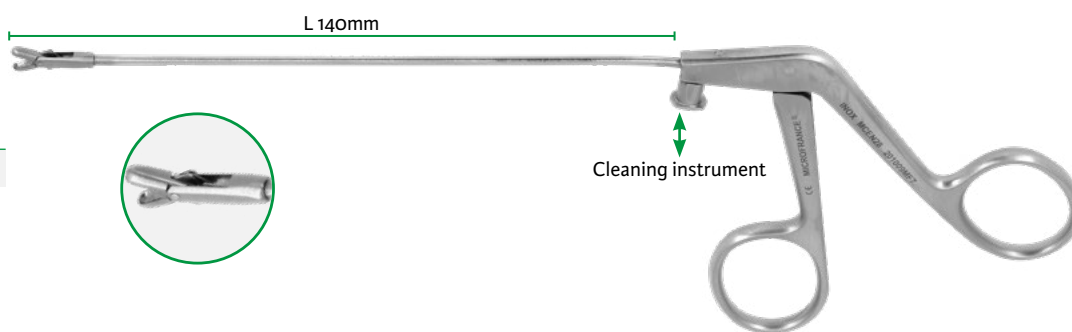

**Albertini**

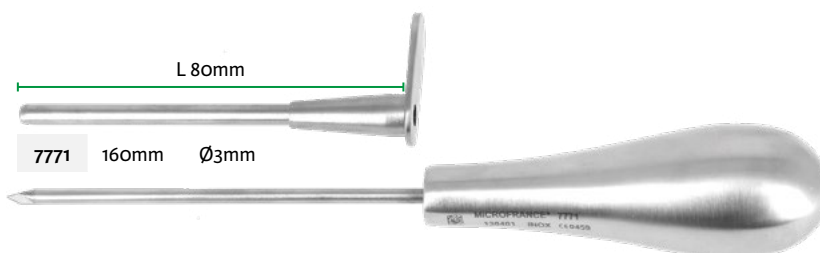

Irrigation tube guide

**Albertini**



<sup>(D)</sup> Distributed by Integra MicroFrance SAS (France) - For corresponding manufacturer part numbers, see table in annex

### Pradès

220mm

MCEN55

7,5mm



### Gillies

230mm

3714379

7mm



Seeker



190mm

MCEN713

ball  
Ø 2,3mm

Pick



160mm

1352431

Ø 0,6mm  
"Mushroom" pick

Herman



235mm

**MCEN127**

Knife  
4x5mm

Friedrich



180mm

**MCEN44**

Sickle knife  
9mm

Rouvier



180mm

**MCEN50**

Dissector  
and knife

Lérault



190mm

**MCEN103**

Angled  
elevator  
3mm

Scale 2/3

L 110mm

Working length "L"

Fenestrated cup jaws



MCEN33	MCEN34
3x6mm	3x6mm

Fenestrated cup jaws



MCEN90	MCEN91	MCEN91B
3x7mm	3x7mm	3x10mm

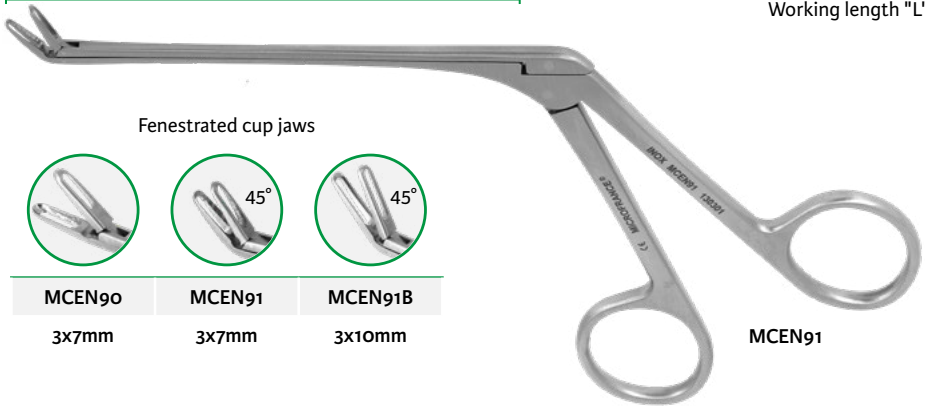

MCEN91

### Blakesley-Klossek

Fenestrated cup jaws, 3mm



MCEN56	MCEN56-1
à droite	à gauche

### Klossek

L 110mm

Suction

Thru-flow suction



7762-5	3mm
--------	-----

Thru-flow suction



7762A-5	3mm
---------	-----



7762-5

### Dessi

L 125mm

Cleaning instrument

0°



45°



90°





MCEN61
3mm

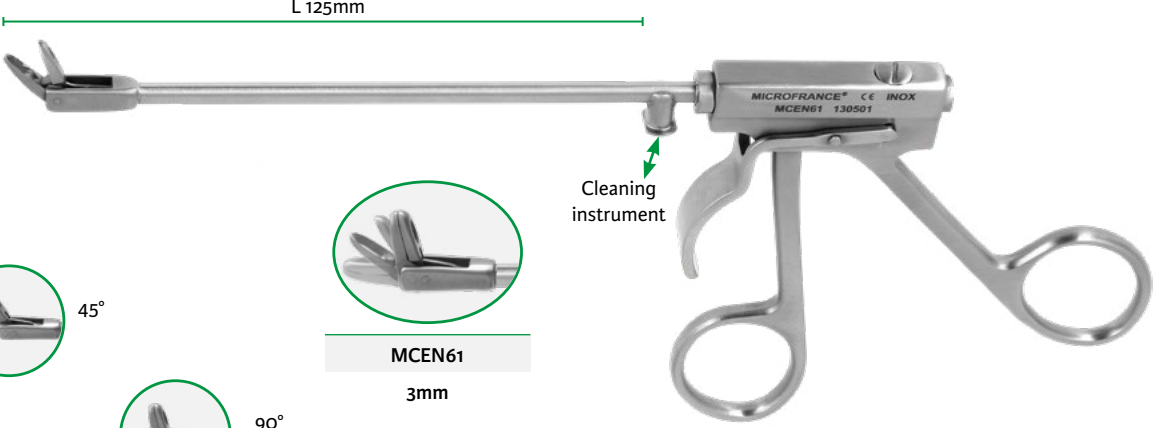

MCEN61

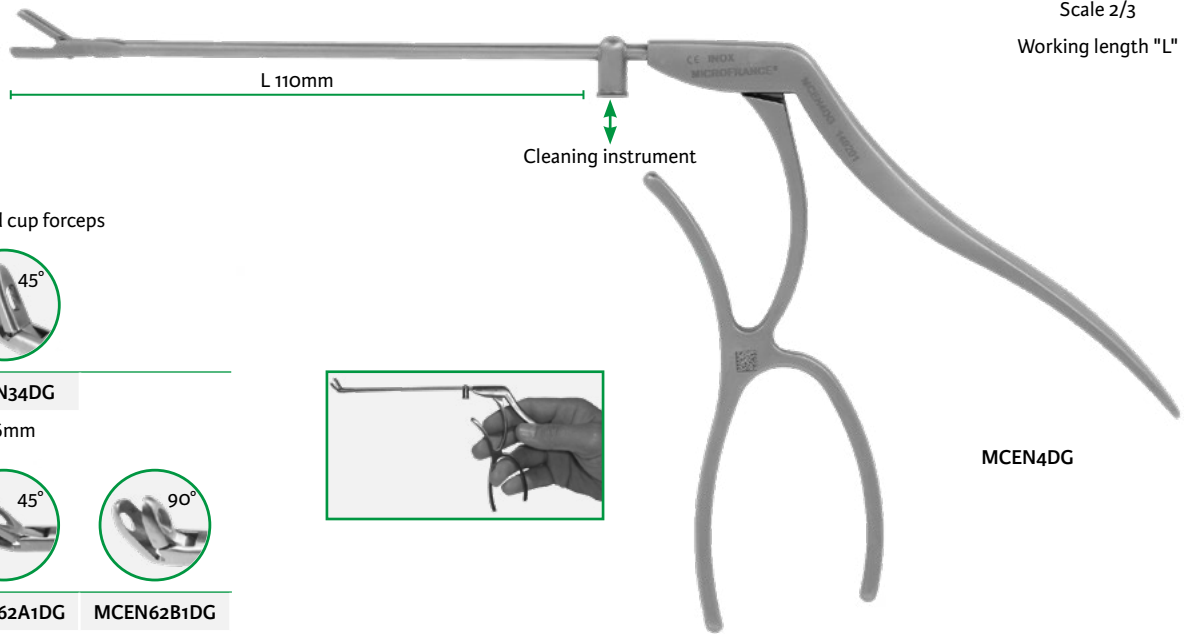

Fenestrated cup forceps



**MCEN33DG**  
3x6mm



**MCEN34DG**  
3x6mm



**MCEN62T1DG**  
3x8mm



**MCEN62A1DG**  
3x8mm



**MCEN62B1DG**  
3x8mm



**MCEN62T2DG**  
5x11mm



**MCEN62A2DG**  
5x11mm



**MCEN62B2DG**  
5x11mm

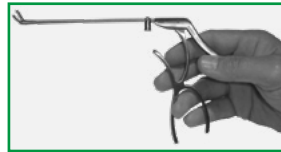

Fenestrated cup forceps



**MCEN90DG**  
3x7mm



**MCEN91DG**  
3x7mm



**MCEN91BDG**  
3x10mm

Cup forceps



**MCEN4DG**  
3x6mm



**MCEN5DG**  
3x6mm



**MCEN5BDG**  
3x12mm

Stylet handle for curette insert

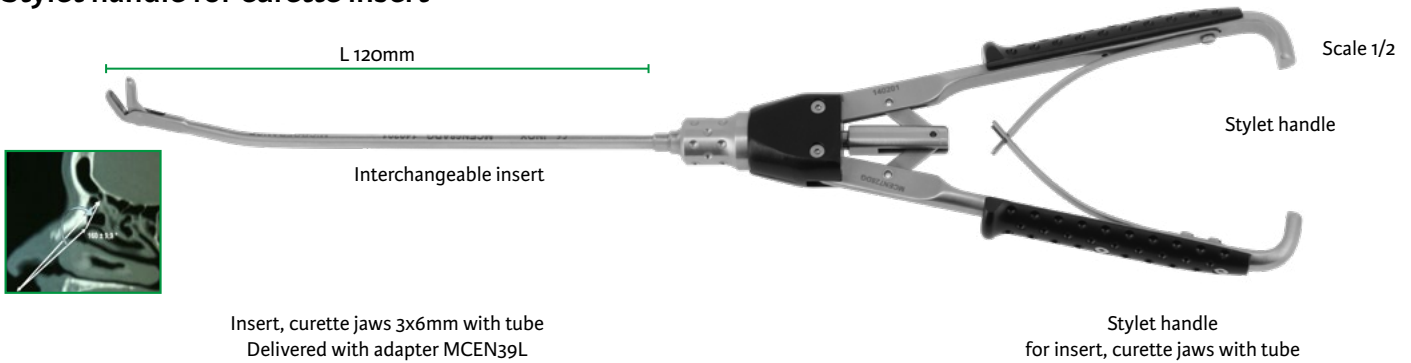

**MCEN68CDG**  
Straight tube



**MCEN68BDG**  
Angled tube



**MCEN68ADG**  
Insert 45°  
angled tube



**MCEN728DG**

Scale 1/4



**MCEN39L**

Scale 1/2

Adapter luer-lock for tube insert cleaning port - Pack 3

Scale 2/3

Working length "L"

Fenestrated cup forceps

Straight      45°      90°



jaws 3x8mm

MCEN62T1    MCEN62A1    MCEN62B1



jaws 5x11mm

MCEN62T2    MCEN62A2    MCEN62B2



jaws 6x11mm

MCEN62T3    MCEN62A3    MCEN62B3



jaws 4x17mm

7762A4



MCEN62A2

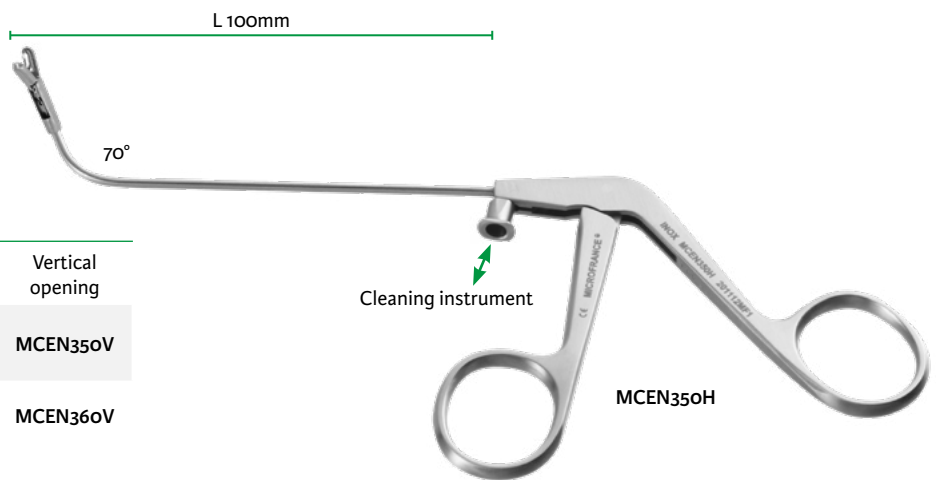

MCEN350H

Cup forceps, curved up



Curve	Horizontal opening	Vertical opening
70°	MCEN350H	MCEN350V
100°	MCEN360H	MCEN360V

Cup forceps, curved up, pear jaws



MCEN960H

curve 80°

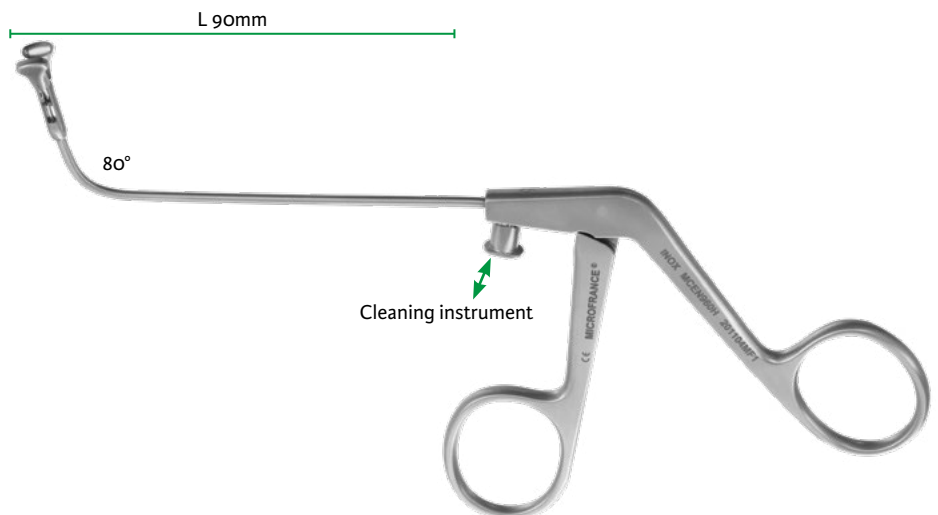

**Rouvier**



**MCEN4**  
3x6mm



**MCEN5**  
3x6mm



**MCEN5B**  
3x12mm



**MCEN43**  
1x4mm  
30°



**MCEN3**  
2mm

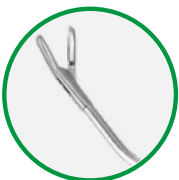

**MCEN29**  
2x5mm  
45°  
right vertical opening

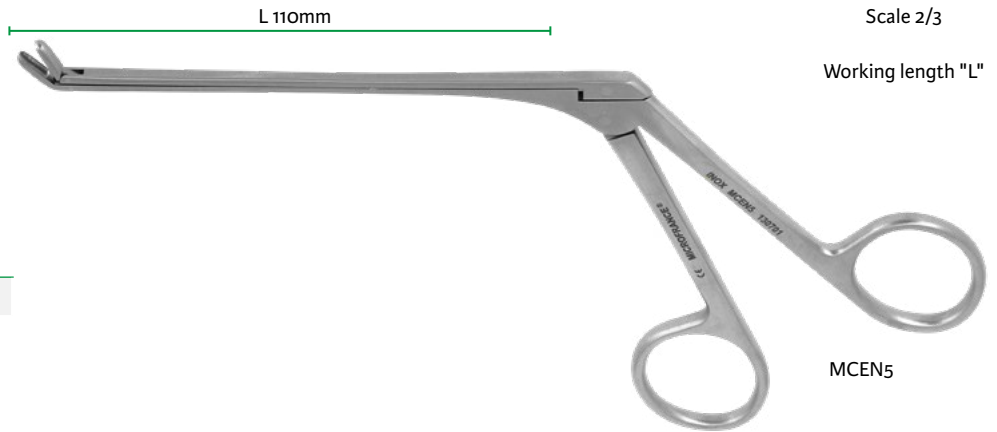

Scale 2/3  
Working length "L"

MCEN5



L 95mm

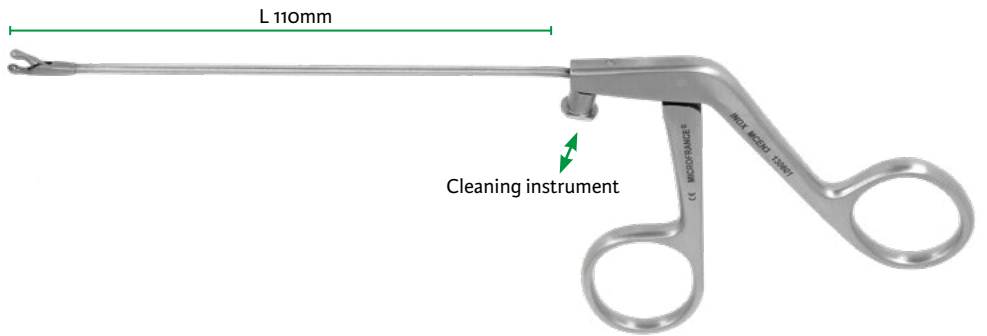

L 110mm

Cleaning instrument

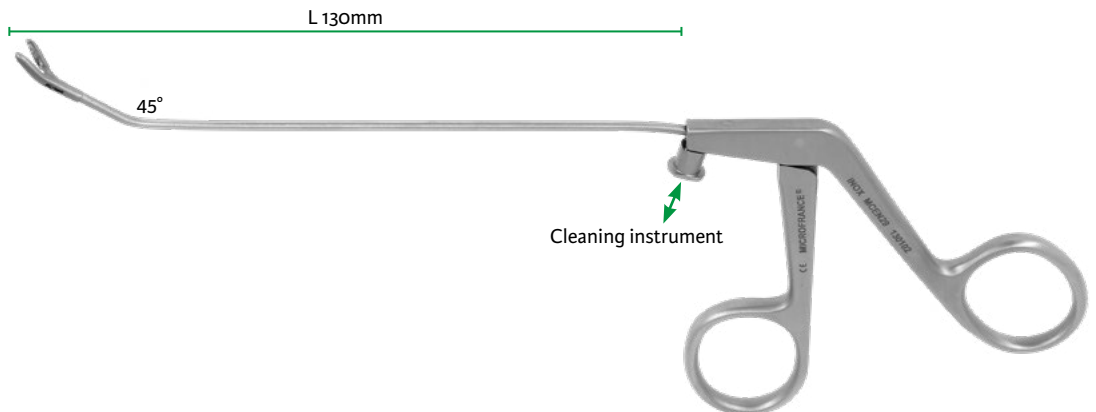

L 130mm

45°

Cleaning instrument

Fenestrated cup forceps

Weil-Blakesley

Blakesley

Straight

45°

90°



7762-1

7762A-1

7762B-1

Jaws 3mm

Weil-Blakesley



7762-2

7762A-2

3.5mm jaws



Scale 2/3

Working length "L"

Fenestrated cup forceps  
Jaws 2mm

straight      45°



7763

7763-1

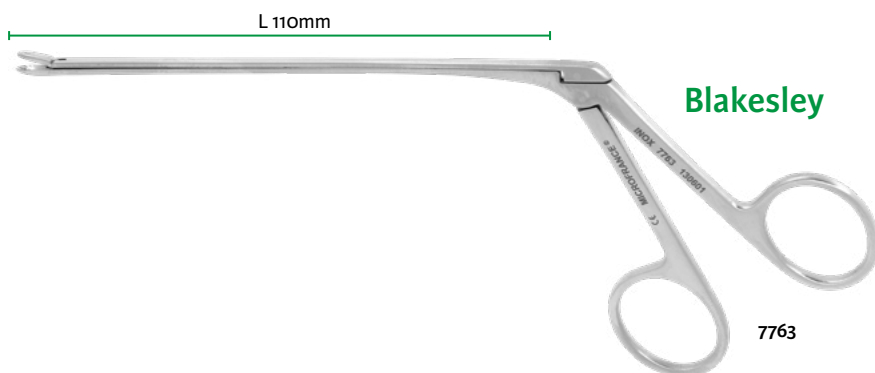

**Blakesley**

7763



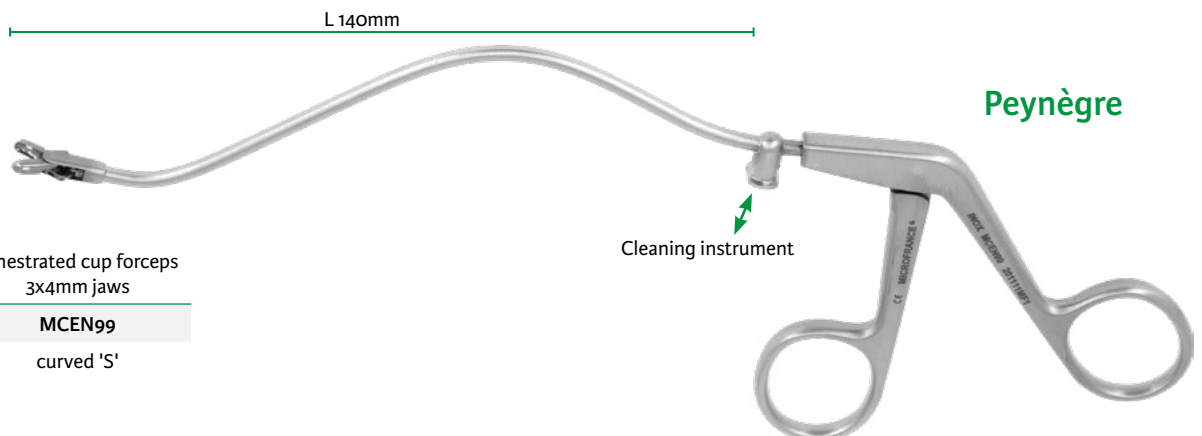
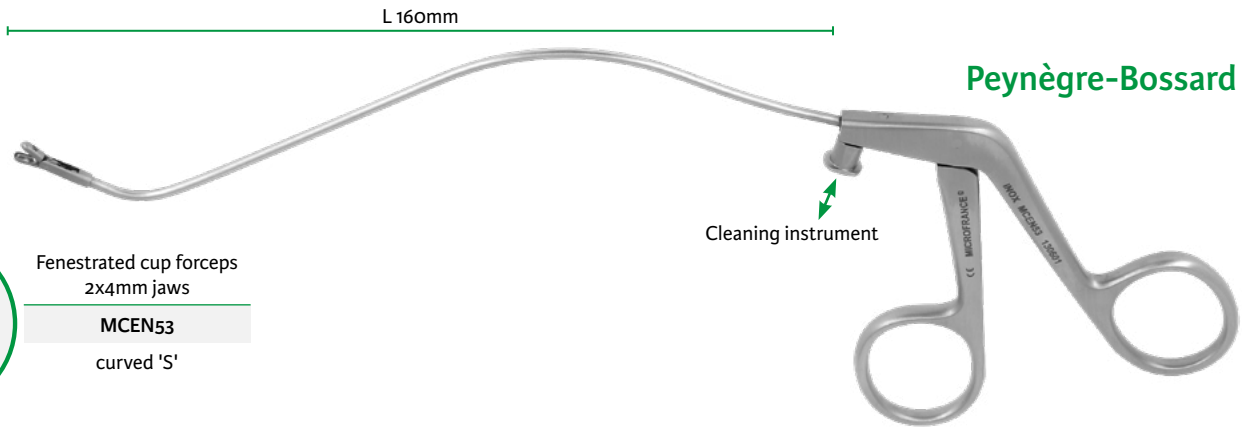
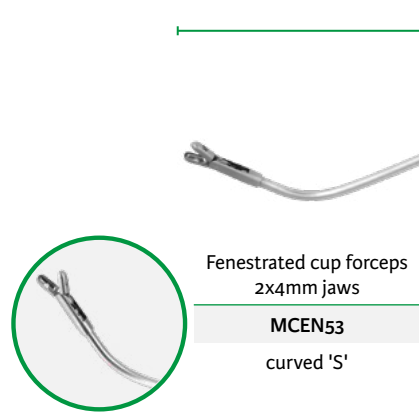
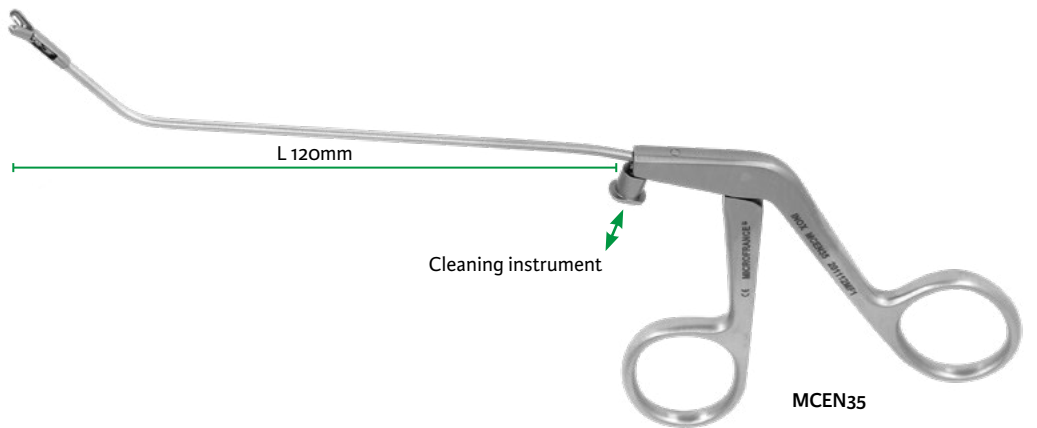
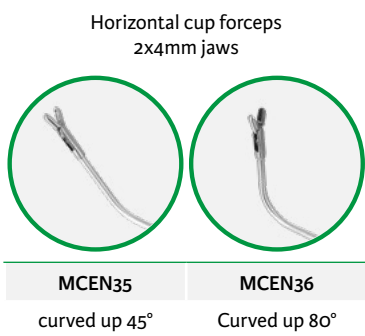
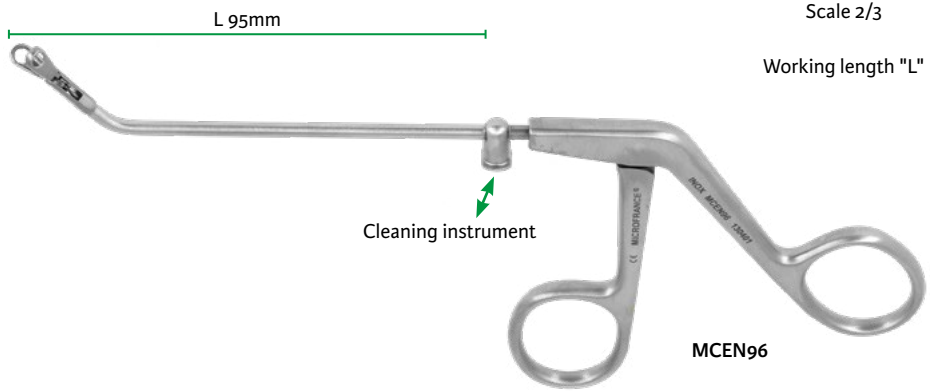
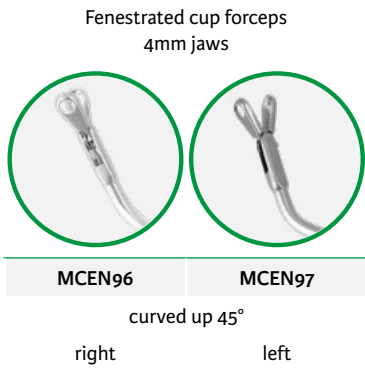

Scale 2/3

Working length "L"

**Orsel**



3x4.5mm Jaws

**MCEN68**

Curved down 130°

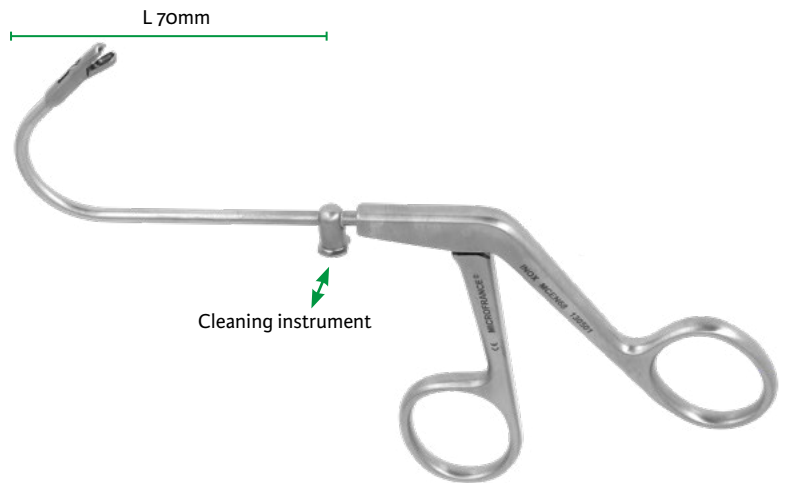

L 70mm

Cleaning instrument

**Terrier**

curved down

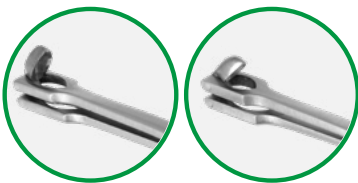

MCEN27-1

3x6mm jaws  
L 100mm

MCEN27

4x7mm jaws  
L 120mm

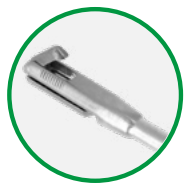
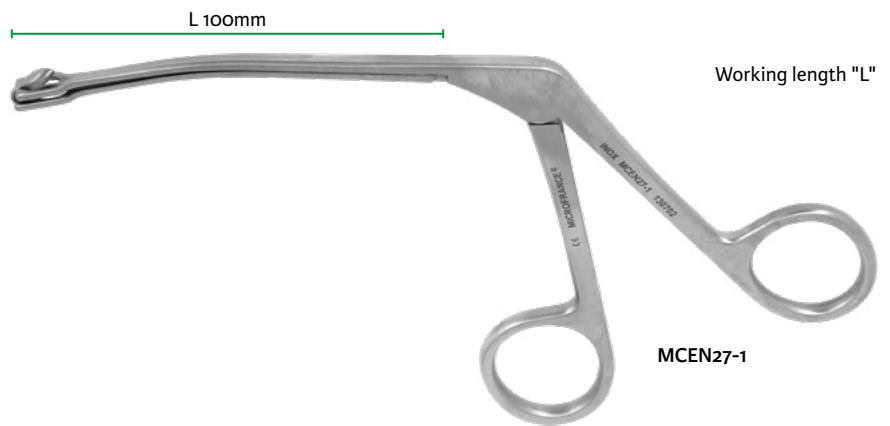

rotatable 360°

MCEN27R

2.5x7mm jaws

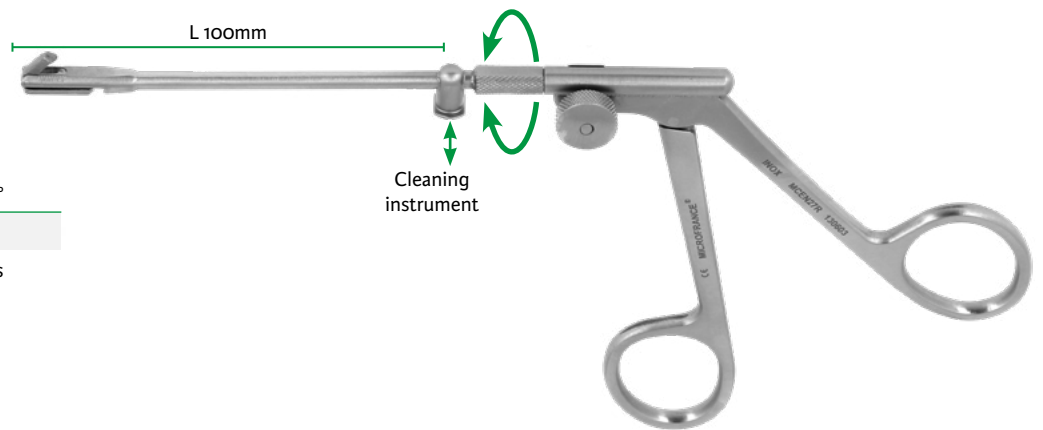

**Terrier**

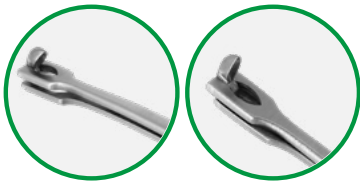

Jaws 2x4mm

<b>MCEN27-2</b>	<b>MCEN27-3</b>
curved down	curved up

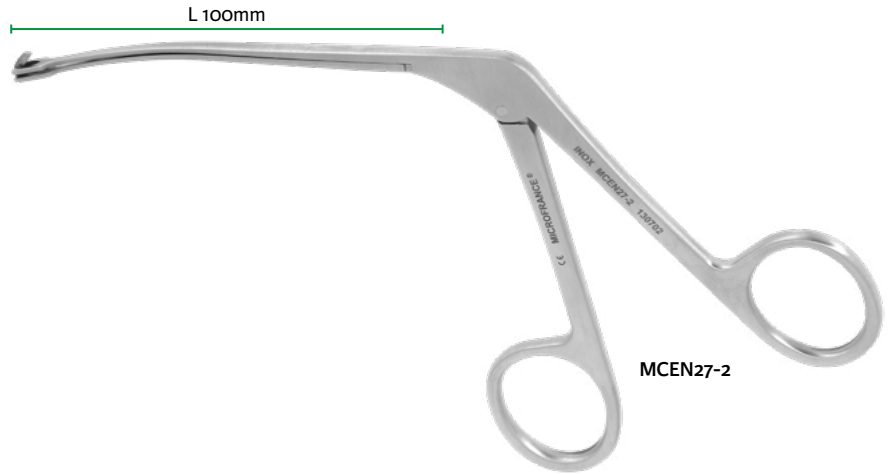

**MCEN27-2**

### Terrier

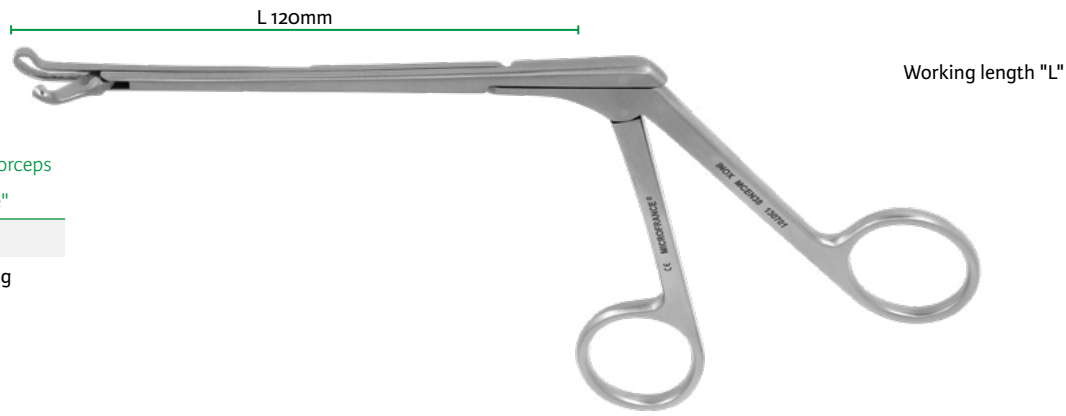

Punch cutting forceps  
"Joséphine"  
**MCEN38**  
left opening

Working length "L"

### Rouvier

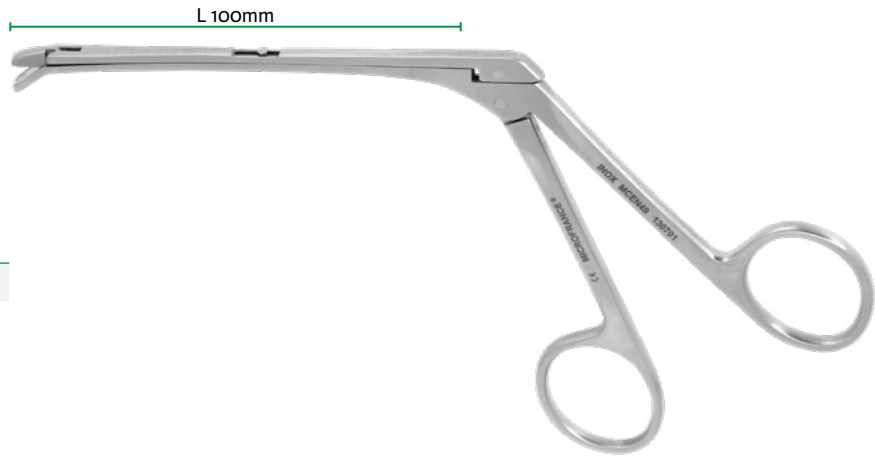

Backbiting punch  
down 30°  
**MCEN49**  
jaws 4mm

Scale 2/3

Working length "L"

**Struycken**

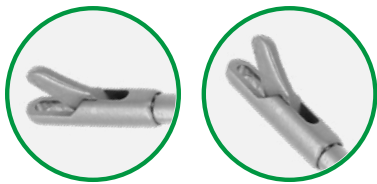

<b>MCEN65</b>	<b>MCEN66</b>
1,5mm straight	1,5mm up 45°

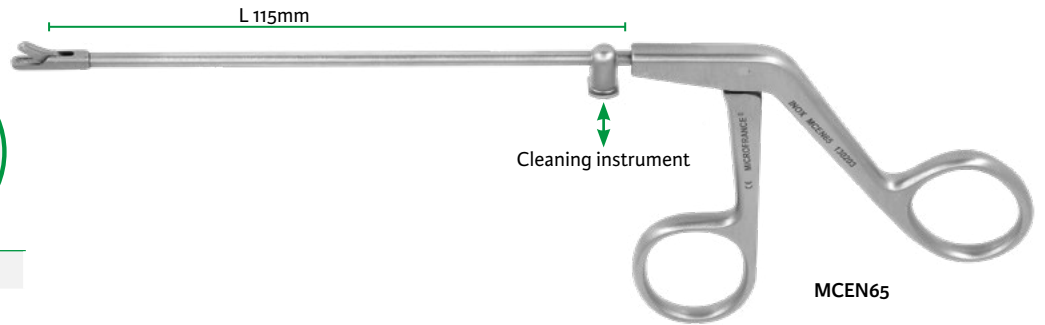

**Struycken**

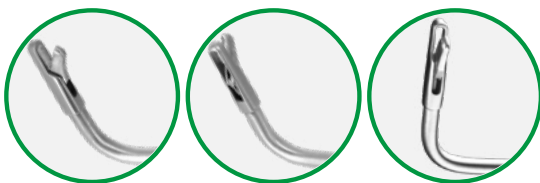

	L 115mm	
<b>MCEN67</b>	<b>MCEN67-1</b>	<b>MCEN67-2</b>
1,5mm	right opening	left opening



### Citelli-Peynègre

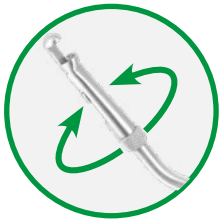

MCE98

3mm

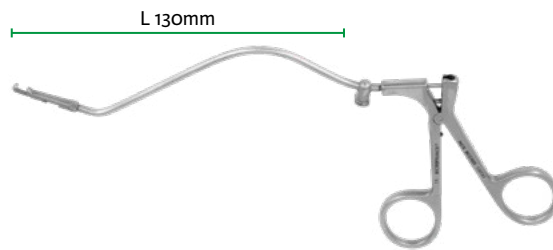

Working length "L"

### Citelli-Frèche



MCE12

4mm - 45°

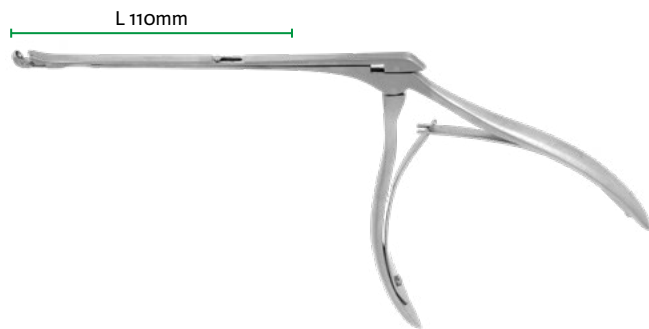

Scale 1/2

**Jankowski**

Titanium serrated blades 15mm



MCEN41J

Straight

MCEN42J

Curved left

MCEN42J1

Curved right

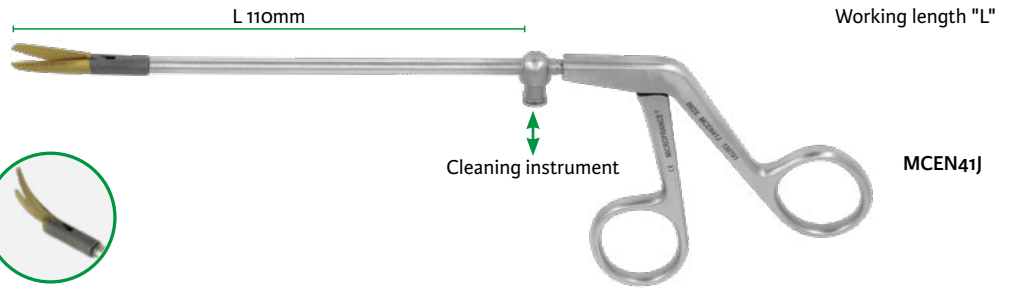

**Dessi**



MCEN41D3

Serrated blades 10mm

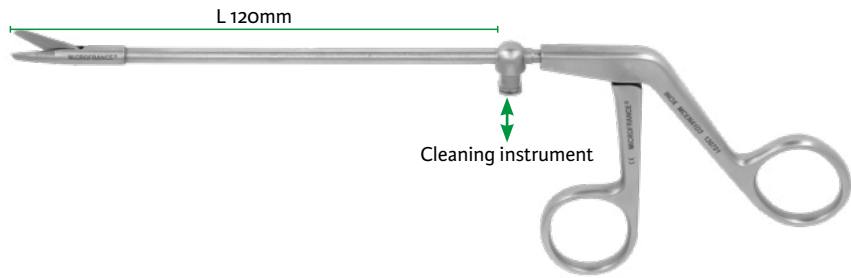

**Peynègre**



Serrated blades 10mm

MCEN41-1

Straight

MCEN42

Curved left

MCEN42-1

Curved right

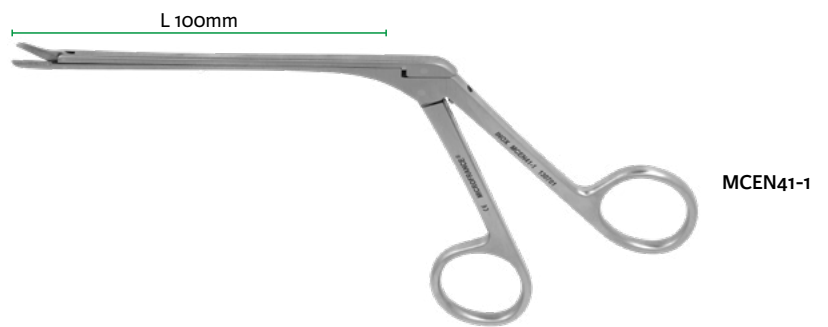



Scale 1/2

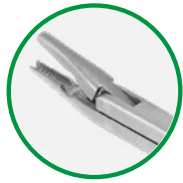

**MCEN21**  
Clip LT200

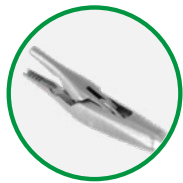
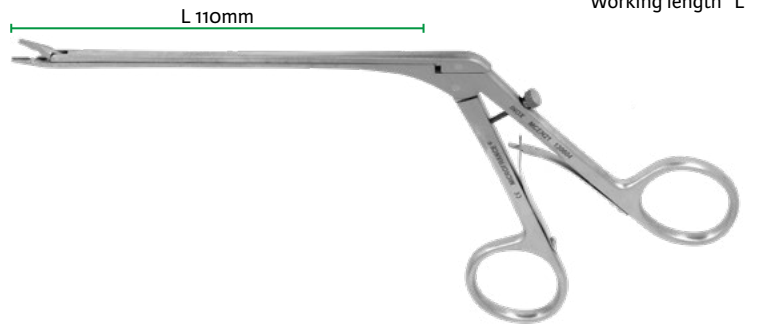

**MCEN21R**  
Clip LT200

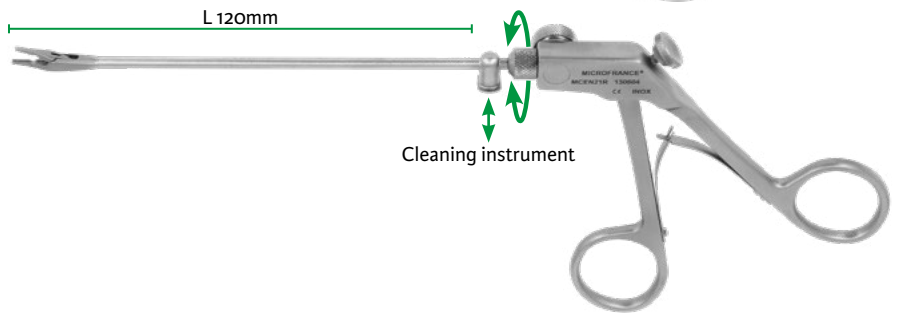

**Wormald**



**MCEN211**  
Clip LT200

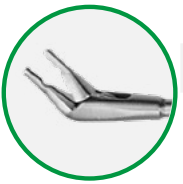

**MCEN211S**  
Clip LT100

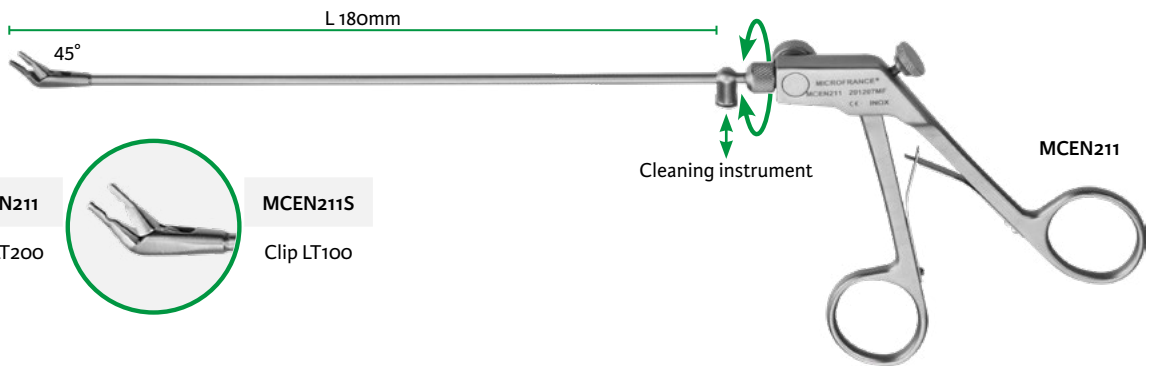

**Wormald**

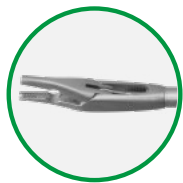

**MCEN212**  
Clip LT200  
**MCEN212S**  
Clip LT100

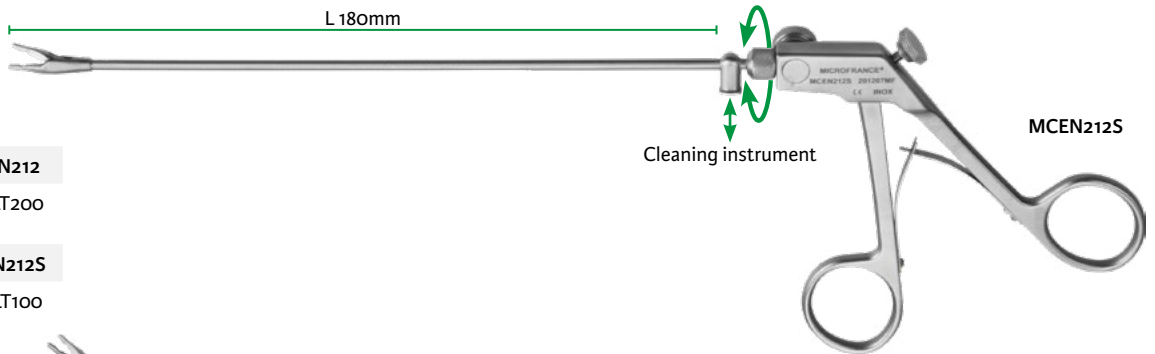

**Wormald**

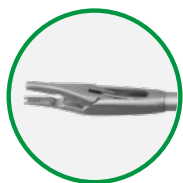

**MCEN213**  
Clip LT200  
**MCEN213S**  
Clip LT100

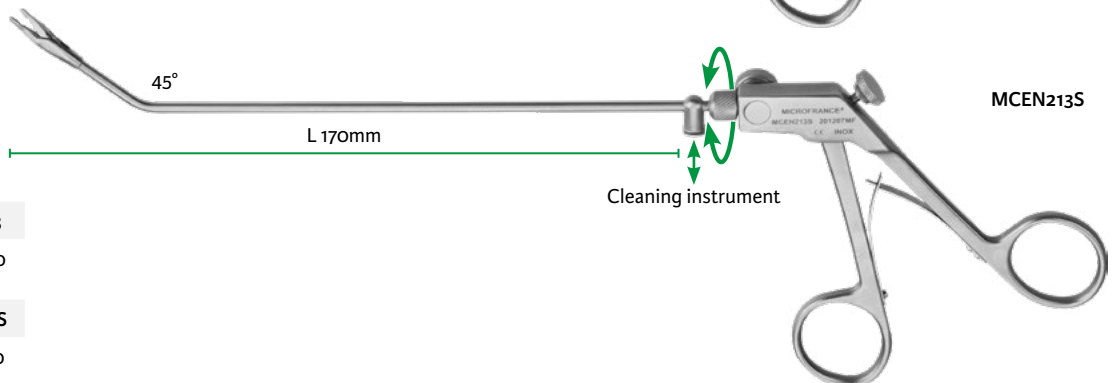

Bipolar forceps, 1 piece instrument

Scale 2/3

Working length "L"

Dessi

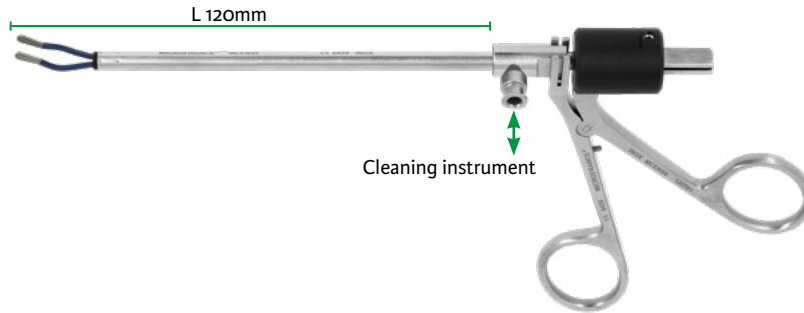

MCEN54

Bipolar forceps, 3-piece instrument

Dessi

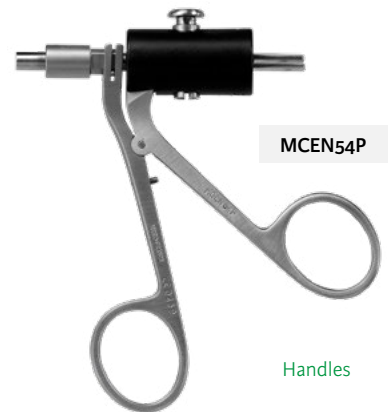
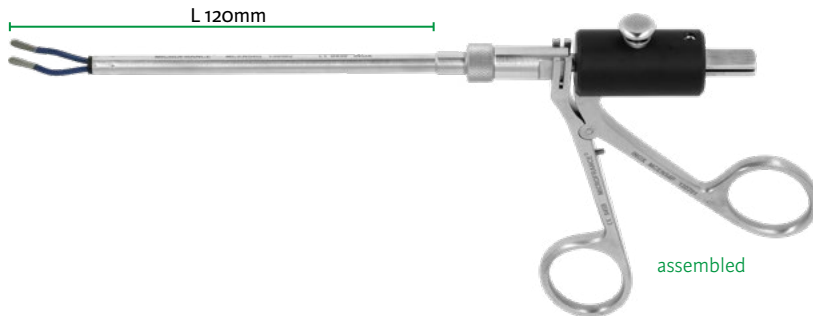

MCEN54P

Handles

MCEN54G



Tube

MCEN54I



Insert

MCEN54H



**Herman**  
Insert



CEV669BG

Bipolar cables - 4,5 m

**CP393-2**  
Bowa Emc Lamidey Valleylab

**CP393-3**  
Erbe VIO ICC ACC (except international) Storz Wolf

**CP393-4**  
Aesculap Berchtold Martin  
Sutter BM-780 II

Scale 1/2

Working length "L"

**Wormald**

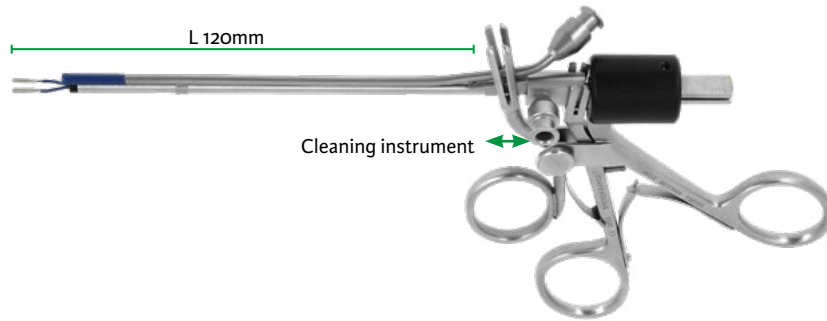
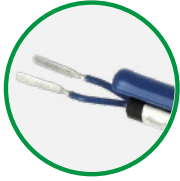

**MCEN64**

**Wormald**

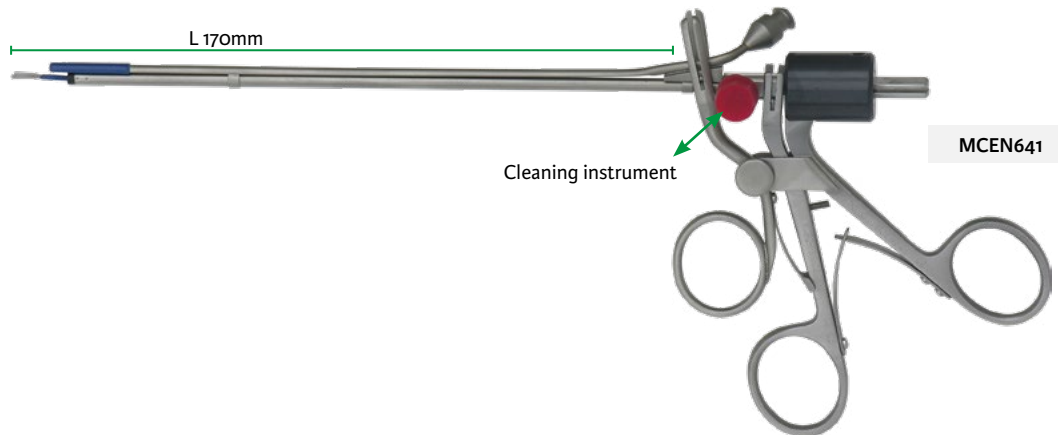
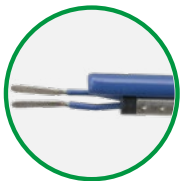

**MCEN641**

**Wormald**

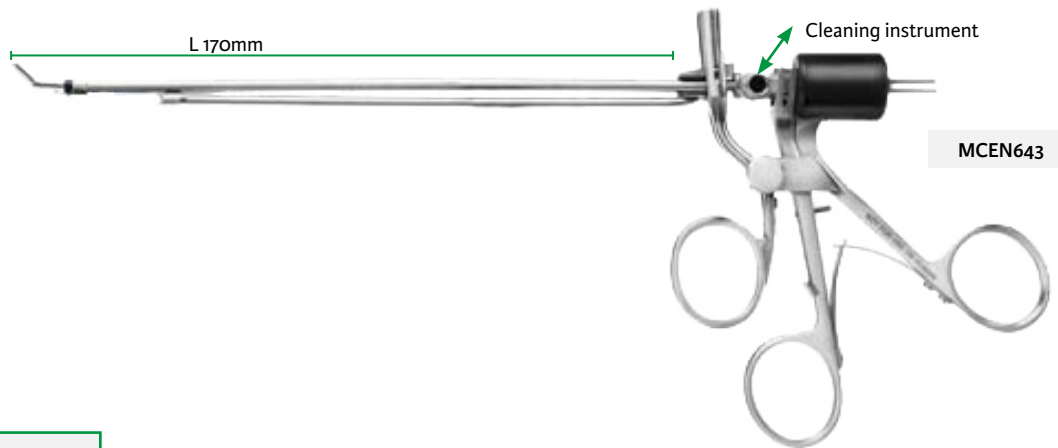

**MCEN643**

Bipolar cables - 4.5 m

- CP393-2**  
Bowa Emc Lamidey Valleylab
- CP393-3**  
Erbe VIO ICC ACC (except international) Storz Wolf
- CP393-4**  
Aesculap Berchtold Martin Sutter BM-780 II



**MCEN640**

Container  
400x260x75mm

Hook

Working length "L"

Scale 1/2

Frèche



90°

L 70mm



200mm

MCEN101

Herman



90° - 5mm

L 125mm



245mm

MCEN128

Suction tube elevator with finger control

Appelbaum



Ø2mm

L 65mm

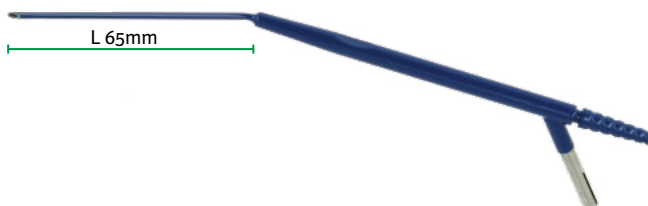

170mm

MCEN730

Suction tube with finger control

Frèche

MCEN100-2-0 2mm

MCEN100-2-5 2.5mm

MCEN100-3-0 3mm

MCEN100-3-5 3.5mm

L 145mm



200mm

MCEN100-2-5

Lancet knife

L 140mm

Frèche



260mm

MCEN105

Picks

L 110mm

Rouvier

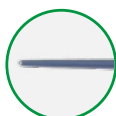

220mm

MCEN11

Rouvier



L 110mm

220mm

MCEN102

with suction

Monopolar cables - 3.5 m



CP391E

Erbe ACC ICC/VIO Storz Wolf



CP391M

Aesculap Berchtold Martin Erbe T Serie  
Lamidey Sutter BM-780 II



CP391V

Bowa Bovie Conmed Valleylab

Drill with adjustable thrust

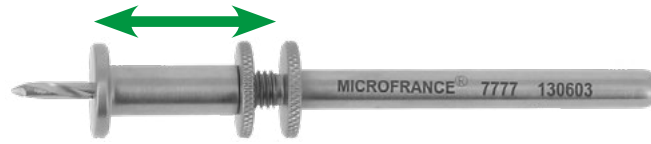

Scale 1/1      7777      85mm      Ø 2mm

Working length "L"

**Nail**

**Lemoine**



7778  
L 15mm



7778-1  
L 10mm

Scale 1/1

**Klossek**



7778K  
L 15mm



7778K1  
L 10mm

**Kennedy Instrumentation - 150mm length**

**Kennedy**

Working length "L"

Scale 1/1

L 105mm

Malleable



Palpation probe  
MCSK1



Sharp hook  
MCSK2



Blunt hook - 90°  
MCSK3



Blunt hook - 150°  
MCSK4



Curette - 1mm  
MCSK6



Suction tube - 2mm  
MCSK5

**Knife and suction tube**

Scale 1/2

Working length "L"

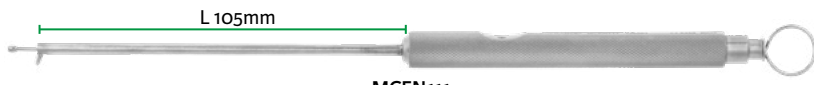

MCEN111  
205mm



MCEN111 4mm - 80°	MCEN112 4mm - 90°	MCEN120 4mm - 135°
----------------------	----------------------	-----------------------

**Thru-flow suction cup forceps**

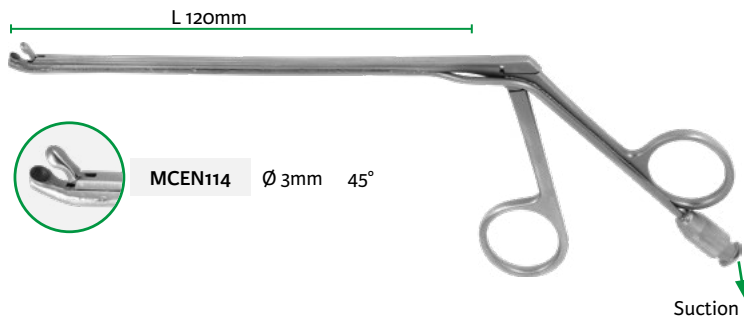

**Suction tube with finger control 170mm length**

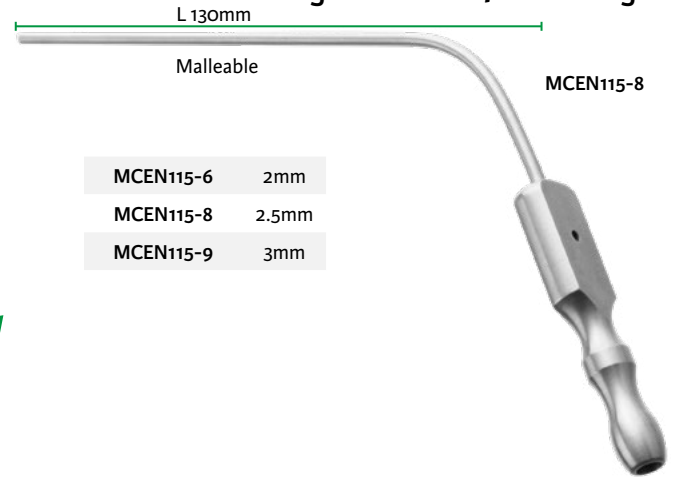

**Cutting circular punch**

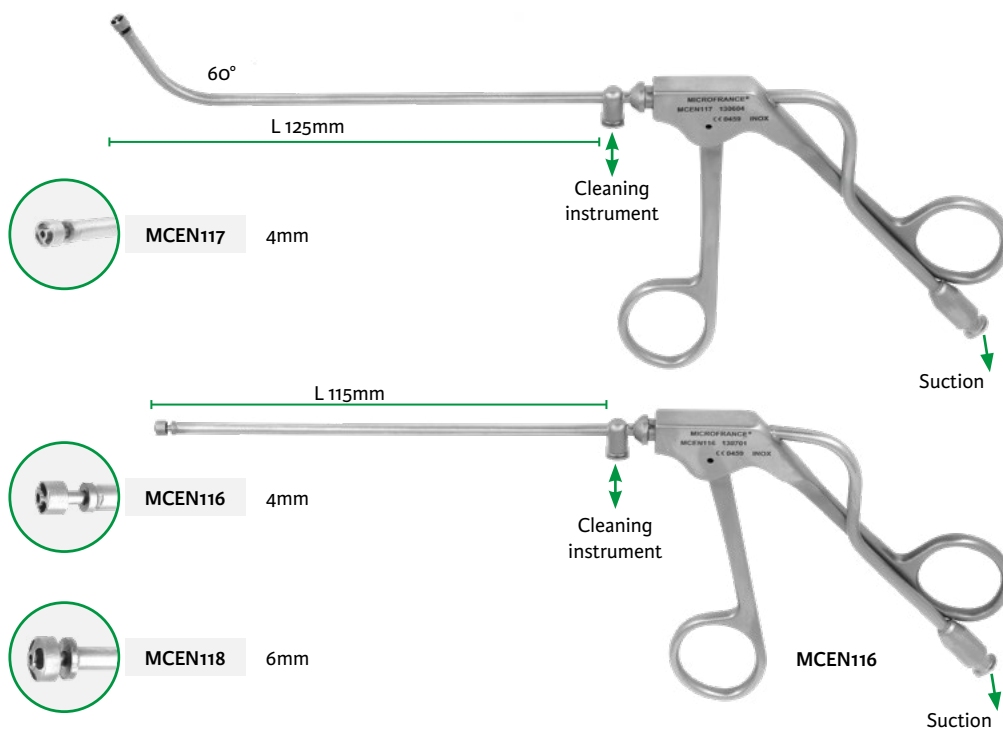

Scale 2/3

**Suction curette with finger control**

Working length "L"

150mm - Ø 3.5mm

**MCEN768** Curette 90°

**MCEN769** Curette 60°

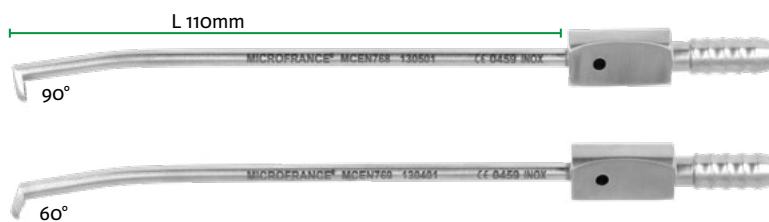

**Double knife**

190mm

**MCEN720**



240mm

**MCEN760**



240mm

**MCEN761**



**Double palpation probe, Double ended seeker**

Double-ended seeker

195mm

**MCEN721**



190mm

**MCEN723**



Double-ended palpation probe

245mm

**MCEN762**



245mm

**MCEN763**



**Angled palpation probe**



MCEN155 180mm

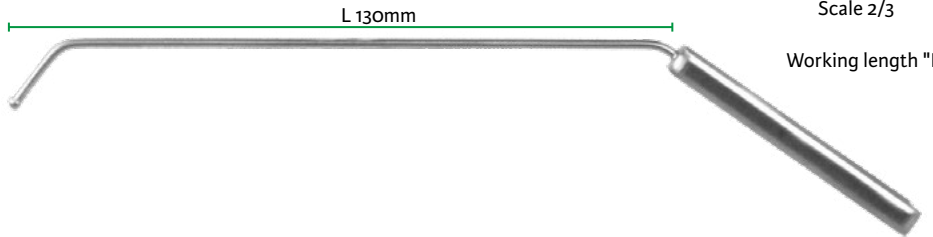

Scale 2/3  
Working length "L"

**Angled elevator**



MCEN157 180mm

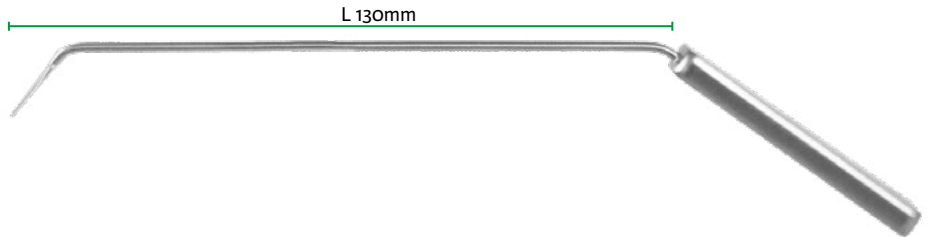

**Blunt suction tube**



MCEN156 185mm  
Ø 2mm

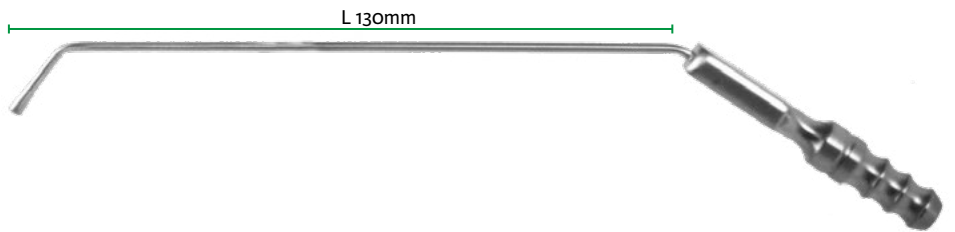

**Angled suction tube elevator**



MCEN158 185mm  
Ø 2mm

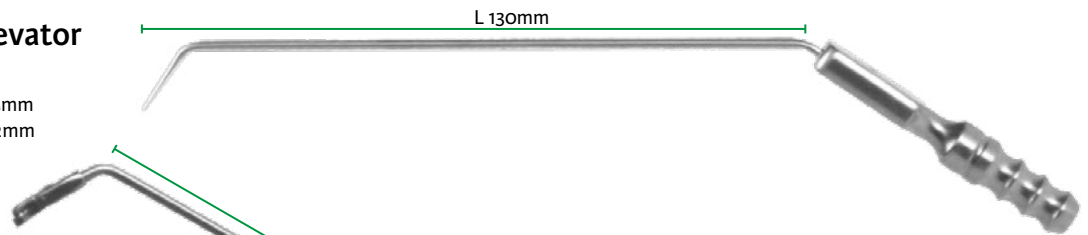

**Cup forceps**

curved down 45°



MCEN151  
vertical



MCEN152  
horizontal

**Thru-cutting forceps**



MCEN153  
vertical



MCEN154  
horizontal

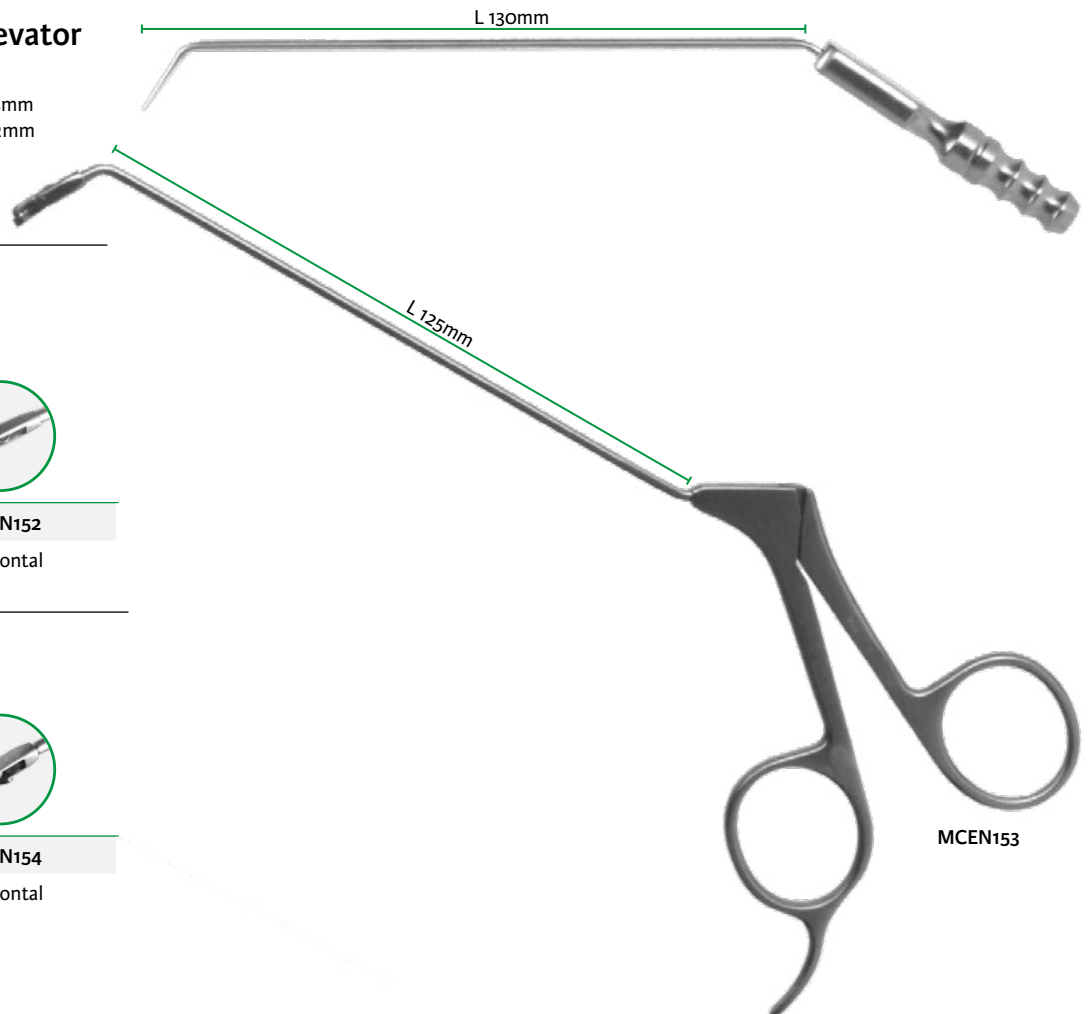

MCEN153



Scale 2/3

Working length "L"

**Blunt loop, Knife and suction tube, suction curette**

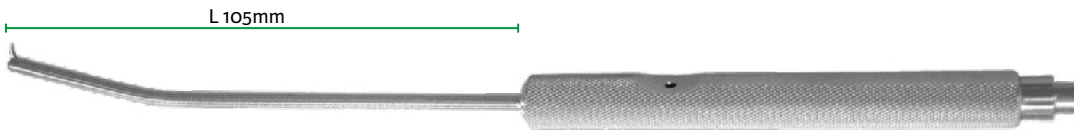

210mm  
MCEN165



Blunt loop



Knife and suction tube



Suction curette

<b>MCEN161</b>	<b>MCEN163</b>	<b>MCEN164</b>	<b>MCEN165</b>	<b>MCEN167</b>
135° - Ø 3mm	90° - Ø 3mm	135° - Ø 3mm	45° - Ø 3mm	90° - Ø 3mm

**Knife, Sickle knife, Loop, curved shaft**

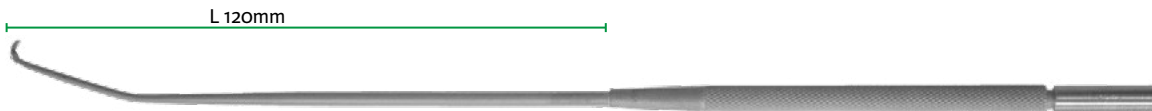

MCEN168



Knife  
90°



Sickle knife  
curved



Blunt loop  
70°

<b>MCEN162</b>	<b>MCEN168</b>	<b>MCEN170</b>
180mm	225mm	250mm

**Double ended perforator elevator**



Perforator

250mm  
MCEN171

Elevator

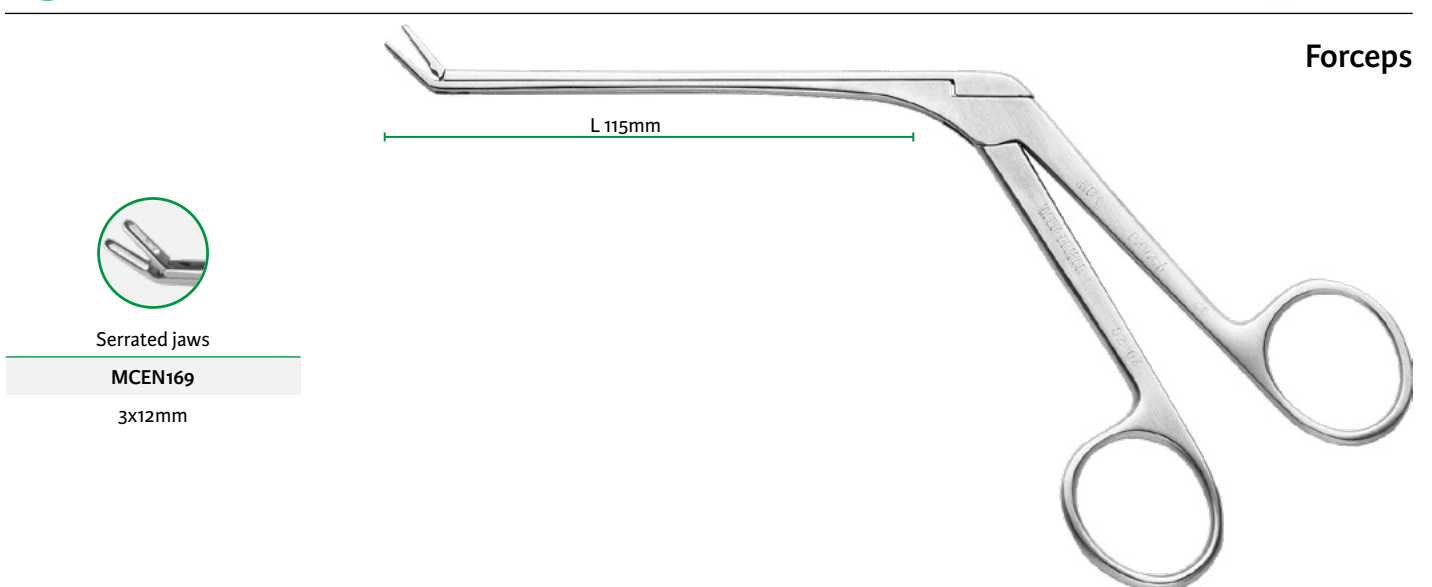

**Forceps**



Serrated jaws

<b>MCEN169</b>
3x12mm

Palpation probe, Suction tube, Suction tube elevator

Scale 2/3

Working length "L"

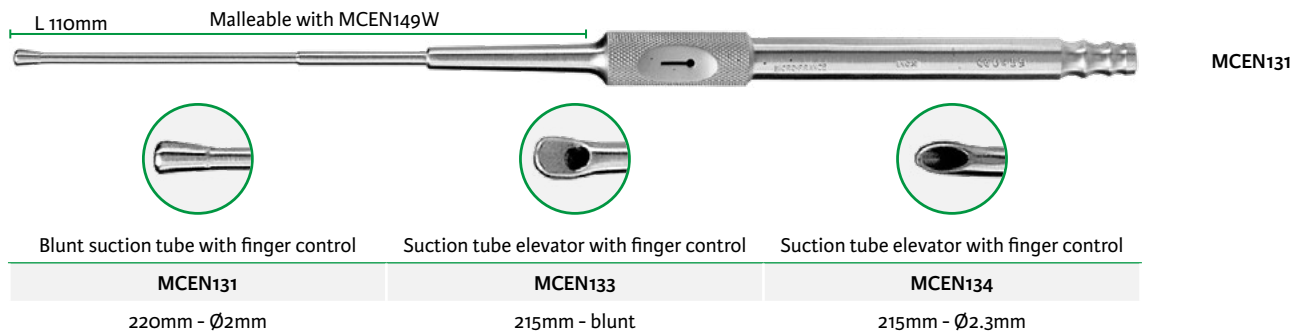

Knot pusher



Scale 1/2

Palpation probe, Suction curette, Basket suction tube, Suction tube elevator

Working length "L"



MCEN142

Suction tube with finger control

Suction curette with finger control

Basket suction tube with finger control

Suction tube elevator with finger control



MCEN138	MCEN138S	MCEN140	MCEN140A	MCEN141	MCEN141A	MCEN142	MCEN147
Ø 3.5mm	Ø 2mm	Ø 2.5mm 45° 4x5mm	Ø 2.5mm 45° 5x6mm	Ø 2.5mm 90° 4x5mm	Ø 2.5mm 90° 5x6mm	Ø 2.5mm	Ø 2.5mm

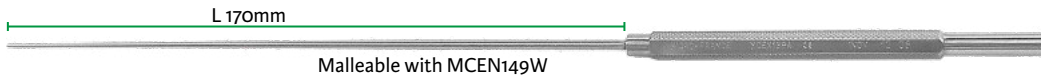

MCEN139A

Palpation probe



MCEN139

MCEN139A

90°

Straight



Suction tube modelling lever

MCEN149W

150mm

Scissors, forceps

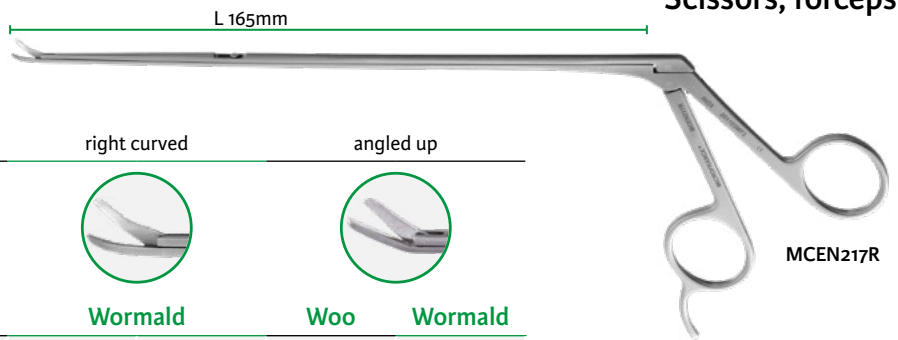

MCEN217R

Scissors

straight

left curved

right curved

angled up



Woo

Wormald

Wormald

Wormald

Woo

Wormald

MCLW10	MCEN217S	MCEN216L	MCEN217L	MCEN216R	MCEN217R	MCLW11	MCEN217U
5mm	8mm	5mm	8mm	5mm	8mm	5mm	8mm

Fenestrated cup forceps, 230mm



MCEN214

MCEN215

straight jaws  
1.5x3.5mm

45° jaws  
1.5x3.5mm

**Needle-holder, tungsten jaws**

Scale 1/2

Working length "L"

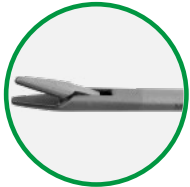

**MCEN218**

tungsten

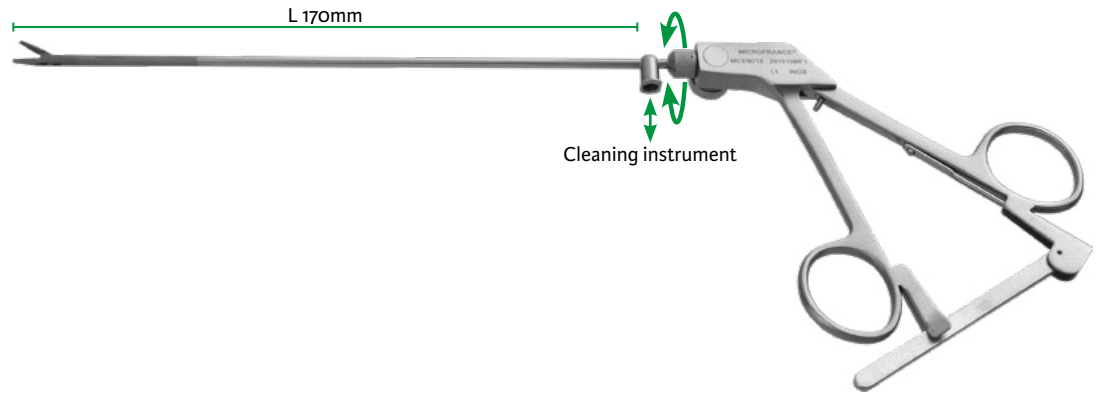

**Debakey clamp, rotatable**



**MCEN191**



**MCEN192**

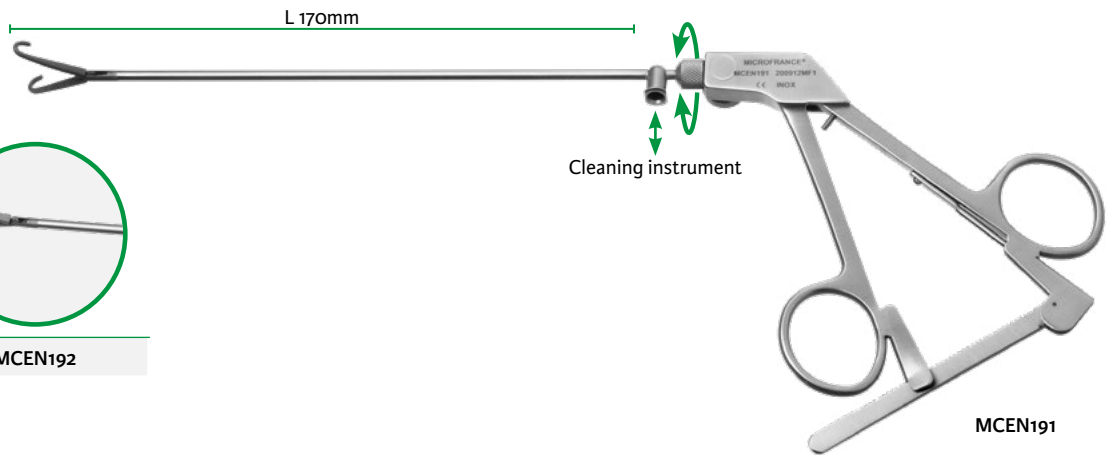

**MCEN191**



**MCEN190**

Straight, angled shaft  
20°

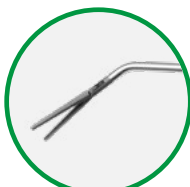

**MCEN193**

Straight, angled shaft  
45°

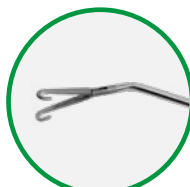

**MCEN194**

Curved, angled shaft  
45°

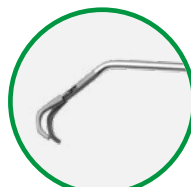

**MCEN195**

Curved, angled shaft  
45°

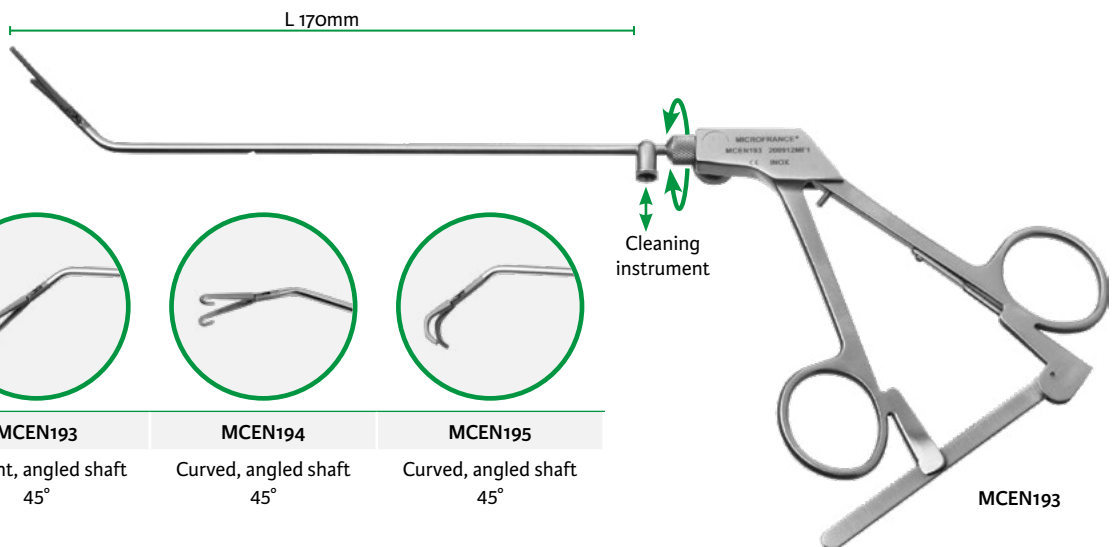

**MCEN193**

Scale 1/2

Working length "L"

**Suction tube with finger control**



210mm  
MCEN349

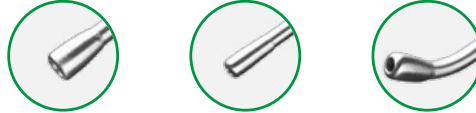

MCEN347	MCEN348	MCEN349
Ø 2mm	Ø 1.5mm	Ø 2mm

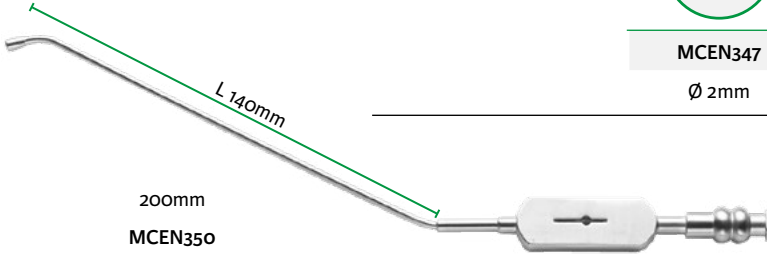

**Suction tube , angulated**

MCEN350	MCEN351
curved down Ø 2mm	curved up Ø 2mm

**Hook, Ball probe, Elevator**



230mm  
MCEN345

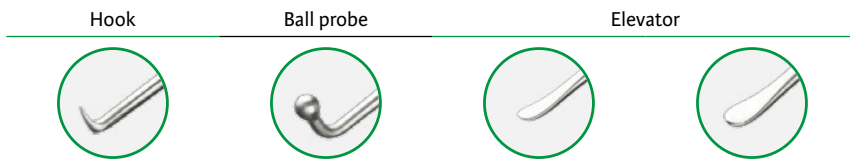

MCEN329	MCEN330	MCEN345	MCEN346
Ø 1.5mm	Ø 3mm	Ø 2mm	Ø 4mm

**Cup forceps, scissors, bipolar forceps with stylet handle**

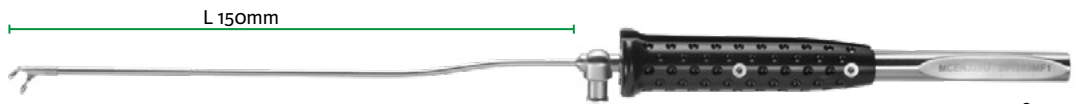

280mm  
MCEN328U

Cup forceps



MCEN328S  
straight  
Ø 2.5mm



MCEN328U  
up  
Ø 2.5mm

Scissors



MCEN344S  
5mm - straight



MCEN344U  
5mm - 45°



MCEN344V  
5mm - curved left

280mm  
MCEN344U

Bipolar forceps

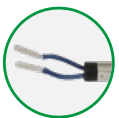

MCEN364  
45° - 1x5mm

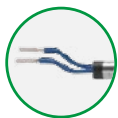

MCEN365  
Bayonet jaws

300mm  
MCEN365

Bipolar cables - 4.5 m

CP393-2  
Bowa Emc  
Lamidey  
Valleylab



CP393-3  
Erbe VIO ICC  
ACC (except  
international)  
Storz Wolf



CP393-4  
Aesculap  
Berchtold  
Martin Sutter  
BM-780 II





Scale 1/2

Stainless steel cup

<b>7876-60<sup>(D)*</sup></b>	60mm
<b>7876-80<sup>(D)*</sup></b>	80mm
<b>7876-100<sup>(D)*</sup></b>	100mm
<b>7876-120<sup>(D)*</sup></b>	120mm
<b>7876-160<sup>(D)*</sup></b>	160mm



Stainless steel tray

<b>7872-24<sup>(D)*</sup></b>	240x180mm
-------------------------------	-----------

Scale 1/4

Stainless steel sterilization case

Scale 1/5

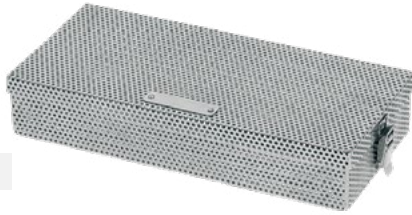

**7874MF-22**

240x105x45mm  
220x100x40mm

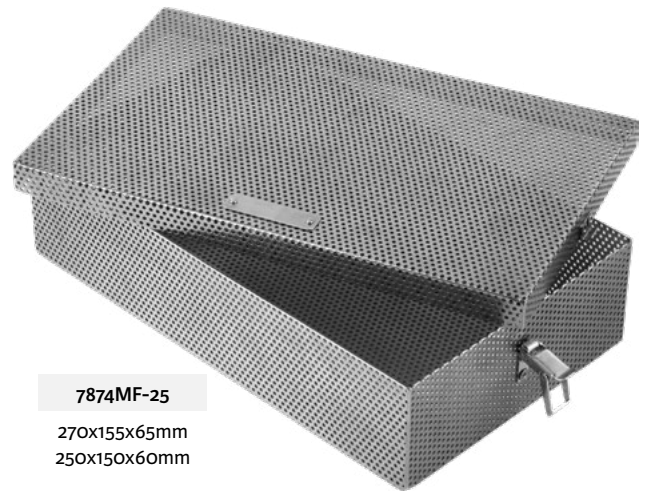

**7874MF-25**

270x155x65mm  
250x150x60mm

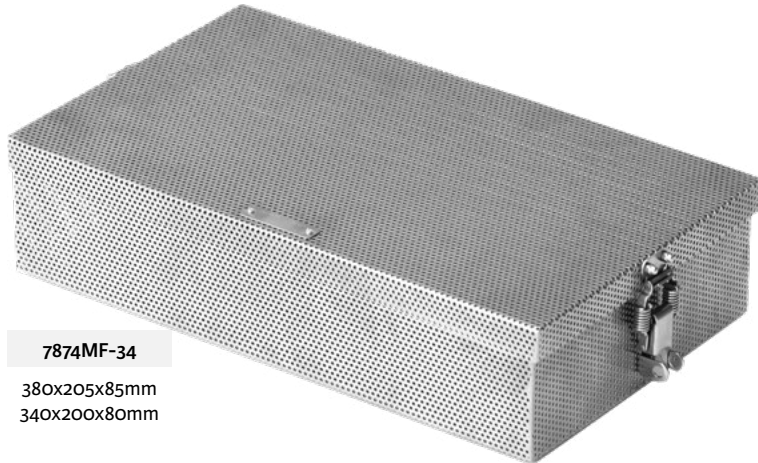

**7874MF-34**

380x205x85mm  
340x200x80mm

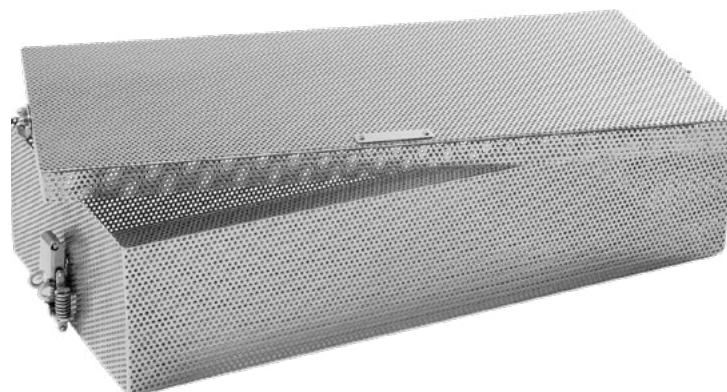

**7874MF-40**

440x205x95mm - 400x200x90mm

<sup>(D)</sup>Distributed by Integra MicroFrance SAS (France) - For corresponding manufacturer part numbers, see table in annex  
\*Please check with your sales representative availability of this product in your country

Scale 1/3

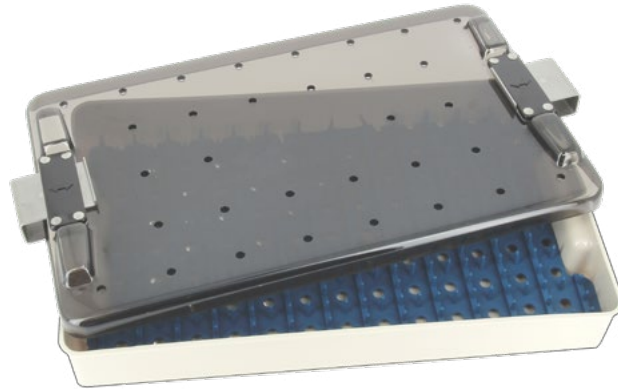

MCE136SC

290x175x55mm  
270x160x35mm

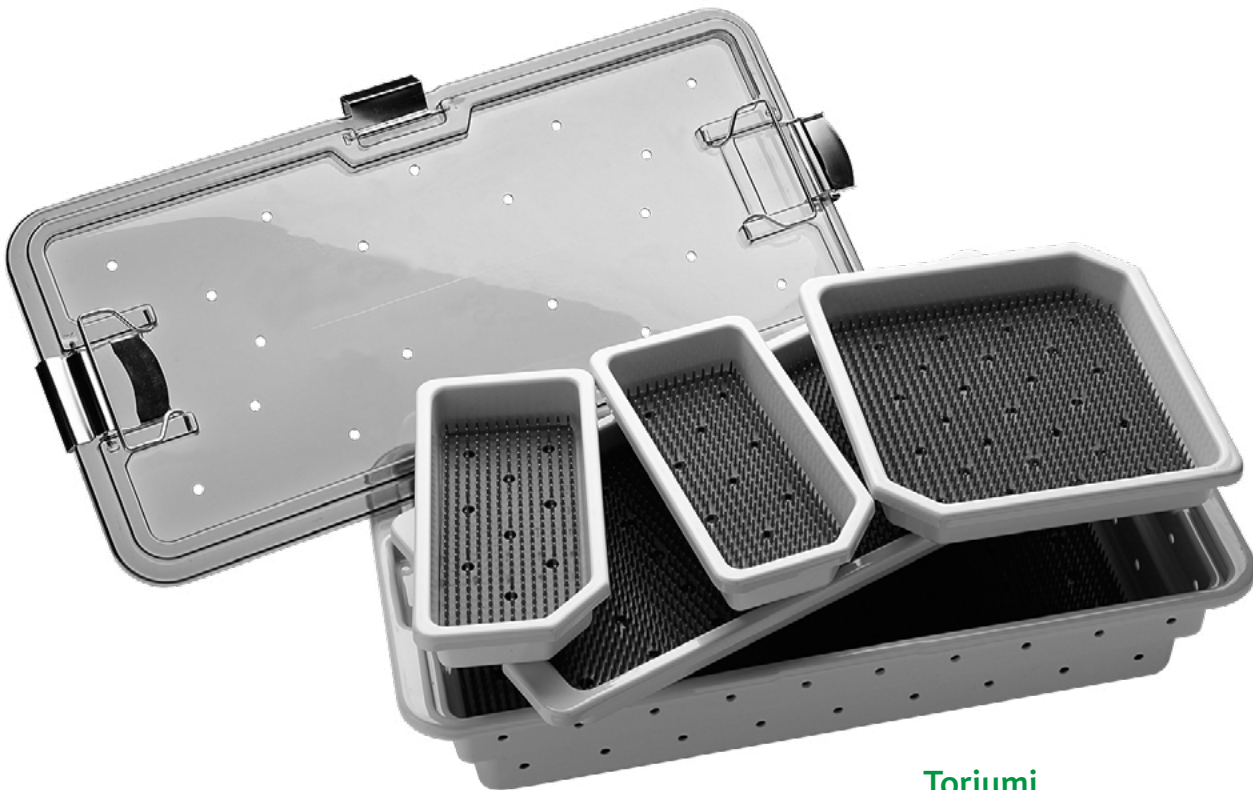

Toriumi

3717011

528x250x123mm





## **Numerical index**

**1**

1003IG <sup>(D)</sup> .....	14
1003LI <sup>(D)</sup> .....	14
1004IG <sup>(D)</sup> .....	14
1005I <sup>(D)</sup> .....	14
1352431.....	77
1375012.....	73
1375020.....	73
1375025.....	73
1375101.....	73
1375102.....	73
1375103.....	73
1375107.....	73
1375110.....	73
1375114.....	73
1375201.....	73
1375207.....	73
1375210.....	73
1375214.....	73

**3**

3714024.....	19
3714025.....	19
3714026.....	19
3714027.....	20
3714028.....	20
3714055.....	28
3714056.....	28
3714057.....	28
3714058.....	28
3714096.....	33
3714098.....	30
3714099.....	30
3714107.....	19
3714108.....	19
3714109.....	19
3714111.....	19
3714148.....	37
3714149.....	37
3714164.....	15
3714166.....	15
3714182.....	22
3714183.....	22
3714187.....	22
3714320.....	28
3714364.....	19
3714379.....	76
3714678.....	15
3717011.....	107
3724059.....	16
3724256.....	19

**7**

7706MF.....	2
7717C.....	2
7719-2.....	3
7722-3.....	2
7726MF.....	7
7727.....	7
7728.....	7
7731.....	3
7732-1.....	7
7733.....	7
7734.....	7
7742-1.....	2
7742-2.....	2
7742-3.....	2
7746A <sup>(D)</sup> .....	2
7746B <sup>(D)</sup> .....	2
7749.....	8
7750.....	8
7761-1.....	8
7761-2.....	8
7761B-1.....	8
7761B-2.....	8
7761BC1.....	8
7761BC2.....	8
7761BC3.....	8
7761C1.....	8
7761C2.....	8
7761C3.....	8
7762-1.....	83
7762-2.....	83
7762-5.....	79
7762A-1.....	83
7762A-2.....	83
7762A4.....	81
7762A-5.....	79
7762B-1.....	83
7763.....	84
7763-1.....	84
7764.....	40
7765.....	44
7766.....	26
7768.....	18
7768-1.....	18
7771.....	75
7771B.....	75
7774.....	24
7777.....	97
7778.....	97
7778-1.....	97
7778K.....	97
7778K1.....	97

7779MF-1.....	9
7779MF-2.....	9
7779MF-3.....	9
7779MF-5CC.....	9
7782-1-2.....	20
7787-10.....	16
7831A-12.....	55
7831A-15.....	57
7831A-18.....	59
7831A-20.....	61
7832.....	61
7833A-12.....	55
7833A-15.....	57
7833A-18.....	60
7833A-20.....	61
7834.....	61
7866-13.....	68
7867-1.....	65
7867-2.....	65
7867-3.....	65
7867-4.....	65
7872-24 <sup>(D)</sup> .....	106
7874MF-22.....	106
7874MF-25.....	106
7874MF-34.....	106
7874MF-40.....	106
7876-60 <sup>(D)</sup> .....	106
7876-80 <sup>(D)</sup> .....	106
7876-100 <sup>(D)</sup> .....	106
7876-120 <sup>(D)</sup> .....	106
7876-160 <sup>(D)</sup> .....	106
7882.....	2
7896-1.....	2
7896-2.....	2
7896-3.....	2
7897.....	4
7898.....	4
7899.....	4

**A**

AQ1728 <sup>(D)</sup> .....	38
-----------------------------	----

**CEV**

CEV669BG.....	94
CEV984.....	6
CEV985.....	6

<sup>(D)</sup> Distributed by Integra MicroFrance SAS (France) - For corresponding manufacturer part numbers, see table in annex

CP

CP16.....	45	CP305.....	30	CP352-3.....	52
CP16-1.....	45	CP305L.....	30	CP353.....	45
CP17.....	18	CP305R.....	30	CP354.....	46
CP17-1.....	18	CP306.....	22	CP354A.....	46
CP17-2.....	18	CP309-8-12.....	31	CP355.....	47
CP17-3.....	18	CP309-10-14.....	31	CP355A.....	47
CP21-3.....	20	CP309-12-16.....	31	CP355C.....	50
CP21A-3.....	20	CP309-14-16.....	31	CP356.....	45
CP23-4.....	22	CP309-14-18.....	31	CP358.....	45
CP23-6.....	22	CP310.....	17	CP358A.....	45
CP23-8.....	22	CP310D.....	17	CP359.....	53
CP23-10.....	22	CP310E.....	17	CP360.....	54
CP23A-8.....	22	CP313.....	32	CP362.....	46
CP37.....	55	CP313-1.....	32	CP363.....	48
CP291.....	35	CP314-14.....	31	CP365.....	50
CP300.....	27	CP315.....	30	CP367.....	47
CP301-1.....	34	CP315D.....	30	CP367-1.....	47
CP301-2.....	35	CP315G.....	30	CP380.....	41
CP301-3.....	35	CP316.....	30	CP380-1.....	41
CP301-4.....	36	CP317.....	29	CP380-2.....	41
CP301-5.....	36	CP318.....	29	CP380-3.....	41
CP301-9.....	36	CP330-3-0.....	69	CP380-5.....	41
CP301-10.....	36	CP330-4-0.....	69	CP381.....	43
CP302-2.....	25	CP331.....	21	CP390-1.....	63
CP302-3.....	25	CP331-1.....	21	CP390-2.....	63
CP302-4.....	25	CP332.....	55	CP390-8.....	63
CP302-5.....	25	CP333.....	15	CP391E.....	63, 96
CP302-6.....	25	CP335.....	20	CP391M.....	63, 96
CP302-8.....	25	CP337.....	13	CP391V.....	63, 96
CP304-2.....	29	CP337-1.....	13	CP392-1R.....	62
CP304-3.....	29	CP338.....	21	CP392-2R.....	62
CP304-4.....	29	CP339.....	21	CP392-8R.....	62
CP304-5.....	29	CP340.....	21	CP392BI.....	62
CP304-6.....	29	CP341.....	21	CP392BS.....	62
CP304-7.....	29	CP344A.....	17	CP393-2.....	62, 94, 95, 105
CP304-8.....	29	CP344AT.....	17	CP393-3.....	62, 94, 95, 105
CP304-9.....	29	CP344B.....	17	CP393-4.....	62, 94, 95, 105
CP304-10.....	29	CP344BT.....	17	CP400.....	57
CP304-11.....	29	CP344C.....	17	CP400-1.....	55
CP304-12.....	29	CP344CT.....	17	CP400-2.....	60
CP304-14.....	29	CP344D.....	17	CP401.....	58
CP304-15.....	29	CP344DT.....	17	CP406.....	55
CP304-16.....	29	CP344E.....	17	CP407.....	57
CP304B-2.....	29	CP344ET.....	17	CP409.....	59
CP304B-3.....	29	CP345.....	58	CP414.....	55
CP304B-4.....	29	CP348.....	53	CP415.....	57
CP304B-5.....	29	CP350.....	54	CP604.....	56
CP304B-6.....	29	CP351-2.....	51	CP604-15.....	56
CP304B-8.....	29	CP351-3.....	51	CP604BR.....	62
CP304B-10.....	29	CP351-6.....	51	CP604M.....	63
CP304B-12.....	29	CP351-7.....	51	CP605.....	56
		CP352.....	52	CP605-15.....	56
		CP352-1.....	52	CP605BR.....	62
		CP352-2.....	52	CP605M.....	63

<sup>(D)</sup> Distributed by Integra MicroFrance SAS (France) - For corresponding manufacturer part numbers, see table in annex



MCEN62A2 .....	81	MCEN90 .....	79	MCEN153.....	100
MCEN62A2DG.....	80	MCEN90DG.....	80	MCEN154.....	100
MCEN62A3 .....	81	MCEN91 .....	79	MCEN155.....	100
MCEN62B1 .....	81	MCEN91B .....	79	MCEN156 .....	100
MCEN62B1DG .....	80	MCEN91BDG.....	80	MCEN157.....	100
MCEN62B2 .....	81	MCEN91DG.....	80	MCEN158.....	100
MCEN62B2DG.....	80	MCEN96.....	85	MCEN161.....	101
MCEN62B3.....	81	MCEN97.....	85	MCEN162 .....	101
MCEN62T1.....	81	MCEN98.....	91	MCEN163.....	101
MCEN62T1DG .....	80	MCEN99.....	85	MCEN164 .....	101
MCEN62T2 .....	81	MCEN100-2-0 .....	96	MCEN165.....	101
MCEN62T2DG.....	80	MCEN100-2-5 .....	96	MCEN167.....	101
MCEN62T3.....	81	MCEN100-3-0 .....	96	MCEN168 .....	101
MCEN64.....	95	MCEN100-3-5.....	96	MCEN169 .....	101
MCEN65.....	90	MCEN101.....	96	MCEN170 .....	101
MCEN66.....	90	MCEN102 .....	96	MCEN171 .....	101
MCEN67 .....	90	MCEN103 .....	78	MCEN183.....	72
MCEN67-1.....	90	MCEN103LDG.....	71	MCEN184 .....	72
MCEN67-2 .....	90	MCEN104.....	24	MCEN186 .....	72
MCEN68.....	86	MCEN105.....	96	MCEN187.....	12
MCEN68ADG.....	80	MCEN106.....	24	MCEN190.....	104
MCEN68BDG.....	80	MCEN107 .....	24	MCEN191.....	104
MCEN68CDG.....	80	MCEN109.....	24	MCEN192 .....	104
MCEN77-3-0.....	72	MCEN111.....	98	MCEN193.....	104
MCEN77-3-5.....	72	MCEN112 .....	98	MCEN194 .....	104
MCEN78J30.....	72	MCEN114 .....	98	MCEN195 .....	104
MCEN78J40 .....	72	MCEN115-6 .....	98	MCEN211.....	93
MCEN79J25.....	72	MCEN115-8 .....	98	MCEN211S.....	93
MCEN79J30 .....	72	MCEN115-9 .....	98	MCEN212 .....	93
MCEN79J40 .....	72	MCEN116 .....	98	MCEN212S .....	93
MCEN81-C .....	74	MCEN117 .....	98	MCEN213.....	93
MCEN81O.....	74	MCEN118 .....	98	MCEN213S .....	93
MCEN81O1.....	74	MCEN120 .....	98	MCEN214 .....	103
MCEN81O2 .....	74	MCEN127.....	78	MCEN215.....	103
MCEN81-S.....	74	MCEN128.....	96	MCEN216L .....	103
MCEN81-W .....	74	MCEN130 .....	102	MCEN216R.....	103
MCEN82-C.....	74	MCEN131 .....	102	MCEN217L.....	103
MCEN82O .....	74	MCEN133.....	102	MCEN217R .....	103
MCEN82O5.....	74	MCEN134.....	102	MCEN217S .....	103
MCEN82O6.....	74	MCEN135.....	102	MCEN217U.....	103
MCEN82-S .....	74	MCEN136SC.....	107	MCEN218 .....	104
MCEN82-W.....	74	MCEN138.....	103	MCEN328S.....	105
MCEN83-C .....	74	MCEN138S .....	103	MCEN328U .....	105
MCEN83O .....	74	MCEN139.....	103	MCEN329 .....	105
MCEN83OL .....	74	MCEN139A .....	103	MCEN330 .....	105
MCEN83-S.....	74	MCEN140 .....	103	MCEN344S.....	105
MCEN83-W .....	74	MCEN140A.....	103	MCEN344U .....	105
MCEN84S(D).....	74	MCEN141.....	103	MCEN344V .....	105
MCEN87C.....	74	MCEN141A.....	103	MCEN345 .....	105
MCEN87O3 .....	74	MCEN142 .....	103	MCEN346 .....	105
MCEN87O4 .....	74	MCEN147.....	103	MCEN347 .....	105
MCEN87-S.....	74	MCEN149W.....	102, 103	MCEN348 .....	105
MCEN87W .....	74	MCEN151 .....	100	MCEN349.....	105
MCEN88SC .....	74	MCEN152.....	100		

MCEN350.....	105
MCEN350H.....	81
MCEN350V.....	81
MCEN351.....	105
MCEN360H.....	81
MCEN360V.....	81
MCEN364.....	105
MCEN365.....	105
MCEN371D4.....	71
MCEN371D35.....	71
MCEN640.....	95
MCEN641.....	95
MCEN643.....	95
MCEN713.....	77
MCEN720.....	99
MCEN721.....	99
MCEN723.....	99
MCEN728DG.....	80
MCEN730.....	96
MCEN760.....	99
MCEN761.....	99
MCEN762.....	99
MCEN763.....	99
MCEN764.....	12
MCEN765.....	12
MCEN766.....	72
MCEN767.....	72
MCEN768.....	99
MCEN769.....	99
MCEN770B25.....	71
MCEN770B30.....	71
MCEN770J30.....	69
MCEN770J40.....	69
MCEN960H.....	81

**MCL**

MCL38N.....	5
MCL170(D)(1).....	5
MCL171(D)(1).....	5
MCL173(D)(1).....	5
MCL174(D)(1).....	5
MCL197(D)(1).....	5

**MCLW**

MCLW10.....	103
MCLW11.....	103

**MCO**

MCO1B.....	70
MCO201-2-5.....	69
MCO201-3-0.....	69
MCO214-13-10.....	28
MCO214-13-20.....	28
MCO214-13-40.....	28
MCO214-13-60.....	28
MCO214-13-80.....	28
MCO233.....	4
MCO237.....	4
MCO305.....	10
MCO311-1-0.....	70
MCO311-1-2.....	70
MCO311-1-5.....	70
MCO311-1-8.....	70
MCO311-2-0.....	70
MCO311-2-5.....	70
MCO311-3-0.....	70
MCO311-3-5.....	70
MCO311-4-0.....	70
MCO770-1-5.....	69
MCO770-2-0.....	69
MCO770-2-5.....	69
MCO770-3-0.....	69
MCO770-3-5.....	69
MCO770-4-0.....	69
MCO771-2-5.....	69
MCO771-3-0.....	69
MCO771-4-0.....	69
MCO772.....	70
MCO775-1.....	70
MCO776.....	70
MCO803.....	10
MCO805.....	3
MCO805A.....	3
MCO807.....	3
MCO950.....	3
MCO978.....	6
MCO978S.....	6
MCO979.....	16
MCO980.....	6
MCO981.....	6
MCO981D.....	6
MCO983-4.....	6
MCO988.....	16
MCO995.....	26

**MCSK**

MCSK1.....	97
MCSK2.....	97
MCSK3.....	97
MCSK4.....	97
MCSK5.....	97
MCSK6.....	97

**P**

P761-7.....	65
P761-8.....	65
P762-2.....	66
P762-4.....	66
P763.....	67
P764-1.....	66
P764-3.....	66
P764-5.....	66
P764-7.....	66
P764-11.....	66
P765-14.....	67
P765-16.....	67
P769.....	67

**S**

SCP337A.....	13
--------------	----

<sup>(D)</sup> Distributed by Integra MicroFrance SAS (France) - For corresponding manufacturer part numbers, see table in annex









**Table for corresponding  
manufacturer part numbers  
For information purposes only**

Integra MicroFrance® product reference	Corresponding manufacturer part number
1003IG	M3IG
1003LI	M3LI
1004IG	M4IG
1005I	M5I
7746A	651
7746B	650
7872-24	1224
7876-100	310
7876-120	312
7876-160	316
7876-60	306
7876-80	308
AQ1728	PS-1728
MCEN84S	MCEN84S
MCL38N	EC-BLU50U090
MCL170 <sup>(1)</sup>	CO101
MCL171 <sup>(1)</sup>	CO201
MCL173 <sup>(1)</sup>	CO100
MCL174 <sup>(1)</sup>	CO200
MCL197 <sup>(1)</sup>	CO103

<sup>(1)</sup> Not a medical device



# Integra® MicroFrance®

## Integra ENT - Nose catalogue



Integra MicroFrance SAS (France)  
Le Pavillon ■ 03160 Saint Aubin le Monial ■ France

CE Class I products only:



HEMODIA SAS  
85, rue du Chêne Vert  
31670 LABEGE ■ France



Concorde Import Export  
B.P. 37  
92300 Levallois-Perret ■ France



Agencinox  
Zone Industrielle  
89110 Aillant sur Tholon ■ France



Qfix  
440 Church Road  
Avondale ■ PA 19311 USA



Advena Limited  
Tower Business Center ■ 2<sup>nd</sup> Floor  
Tower Street ■ Swatar ■ BKR 4013 Malta



Sunoptic Technologies®, LLC  
6018 Bowdendale Avenue  
Jacksonville ■ FL 32216 USA



AJW Technology Consulting GmbH  
Breite Straße 3  
40213 ■ Düsseldorf ■ Germany



Swann Morton Ltd  
Penn Works ■ Owlerton Green ■ Sheffield  
South Yorkshire S6 2BJ ■ United Kingdom



Emergo Europe  
Prinsessegracht 20  
2514 AP ■ The Hague ■ The Netherlands

Availability of these products might vary from a given country or region to another, as a result of specific local regulatory approval or clearance requirements for sale in such country or region.

- Consult product labels and inserts for any indications, contraindications, hazards, warnings, precautions, and instructions for use.
- Non contractual document. The manufacturer reserves the right, without prior notice, to modify the products in order to improve their quality.
- Warning: Applicable laws restrict these products to sale by or on the order of a physician.

#### Additional information for EMEA Customers only :

Products mentioned in this document are CE class I, Im, IIa or IIb devices. Contact Integra should you need any additional information on devices classification.  
All the medical devices mentioned on this document are CE marked in accordance with the applicable European laws, unless specifically identified as "NOT CE MARKED".  
Products marked with the symbol<sup>(®)</sup> are distributed by Integra MicroFrance SAS (France).

Date of last révision : 04/2023

## For more information, please contact customer service :

### Europe, Middle-East, Africa

International: +33 (0) 437 47 59 50 ■ +33 (0) 437 47 59 25 (Fax) ■ [csemea@integralife.com](mailto:csemea@integralife.com)  
France: +33 (0) 437 47 59 10 ■ +33 (0) 437 47 59 29 (Fax) ■ [custservfrance@integralife.com](mailto:custservfrance@integralife.com)  
United Kingdom: +44 (0) 1264 312 725 ■ +44 (0) 1264 312 821 (Fax) ■ [custsvcs.uk@integralife.com](mailto:custsvcs.uk@integralife.com)  
Belgium & Luxembourg: +32 (0)2 257 4130 ■ +32 (0)2 253 2466 (Fax) ■ [custsvcbenelux@integralife.com](mailto:custsvcbenelux@integralife.com)  
Netherlands: +31(0) 852 083 167 ■ +31(0) 207 093 627 (Fax) ■ [custsvcnetherlands@integralife.com](mailto:custsvcnetherlands@integralife.com)  
Italy: +39 (0)2 577 8921 ■ +39 (0)2 575 113 71 (Fax) ■ [custsvcitaly@integralife.com](mailto:custsvcitaly@integralife.com)  
[integralife.eu/contact](https://integralife.eu/contact)

Integra and the Integra logo are registered trademarks of Integra LifeSciences Corporation or its subsidiaries in the United States and/or other countries.

MicroFrance is a trademark of Integra LifeSciences Corporation or its subsidiaries.  
All other trademarks and product names are the property of their respective owners.

© 2023 Integra LifeSciences Corporation. All rights reserved.

0332452-5-EN

DOCUMENT FOR USE IN EUROPE, MIDDLE-EAST AND AFRICA ONLY.