

Integra[®] MicroFrance[®]

Integra ENT - Ear catalogue

Table of contents	ii	Small scissors, blunt tip, matt finish	27	Micro scissors - Micro cup forceps	45
Warranty and Customer Service Information	iv	Metzenbaum scissors, small, matt finish	28	Microcut forceps	46
Indications / Contraindications	v	Mayo scissors, matt finish	29	Micro piston forceps	47
Diagnosis	2	Fine dissecting forceps	30	Micro knife	48
Angled stylet probe caustic holder	2	Adson dissecting forceps	31	Micro chisel	48
Cotton carrier	2	with serrated jaws	31	Micro double instrument	48
Micro hook	2	with teeth	31	Micro Knife	48
Loop	3	Medium dissecting forceps	32	Oval knife	48
Kidney bowl	4	Medium bipolar dissecting forceps	33	Sickle knife	48
Myringoplasty	5-6	Bipolar cables	33	Suction round knife	48
Scalpel	7	Forceps with serrated jaws	33	Micro mirror - Micro raspatory - Micro elevator	49
Speculum	8-9	Forceps with smooth jaws	33	Straight curette - Micro curette	50
Diagnosis speculum	8	Forceps with teeth	33	Micro double curette 155mm	50
Dilator	9	Medium monopolar dissecting forceps	34	Micro angled curette 160mm	50
Self-retaining speculum	9	Adson forceps	34	Micro angled double curette 155mm	50
Speculum with handle	9	Forceps with serrated jaws	34	Micro fenestrated curette 165mm	50
Flexible tension arm	10	Forceps with smooth jaws	34	Micro straight curette 170mm	50
Angled dissecting forcep	11	Forceps with teeth	34	Micro straight double curette 170mm	50
with serrated jaws	11	Monopolar cables	34	Volkmann straight curette 170mm	50
with spoon jaws	11	Tungsten needle-holder	35	Micro pick - Tenotome probe	51
with teeth	11	Fine haemostatic forceps	36	Micro hook	52
Syringe	12	Medium haemostatic forceps	37	Miscellaneous micro hook - Micro raspatory	53
Replacement tube	12	Haemostatic forceps, serrated jaws	38	Micro hook - Micro raspatory	53
Syringe luer-lock	12	Towel clamp - Forceps with teeth	39	Micro instrument, spoon handle	53
Washer for syringe	12	Suction tube with finger control	40	Micro joint knife	53
Elevator - Raspatory	13	Jankowski	40	Micro raspatory	53
Curved raspatory	14	Lempert	40	Micro coagulation	54
Retractor	15-16	Suction irrigation tube with finger control	40	Bipolar cables	54
Curved self-retaining retractor	17	Wertheimer	40	Bipolar forceps	54
Self-retaining retractor	18	Micro suction tube - Adapters	41	Monopolar cables	54
Large self-retaining retractor	19	Micro suction tube with finger control	42	Monopolar curved elevator	54
Articulated self-retaining retractor	20	Micro suction tube	43	Monopolar pick	54
Mallet	21-22	Angled suction with luer-lock	43	Micro measuring rod	55
Chisel - Gouge	23	Blunt eyes suction tube	43	Prosthesis placement	56-58
Rongeur	24	Micro malleable suction tube	43	Ossiculoplasty sizer	56
Double-action rongeur	25	Micro forceps with serrated jaws - Alligator forceps	44	Punch for silastic	56
Small scissors, pointed blades, matt finish	26	Alligator forceps	44	Schuknecht device	56
		Micro forceps with serrated jaws	44	Wire guide	56
				Cartilage cutting block	57
				Fascia press	57
				Replacement blade for cartilage cutting block	57
				Hand drill perforator	58
				Piston trimming gauge	58
				Preparation glass plate	58

Teflon cutting block	58	Selesnick set	74-75
Otoplasty - Suction foot switch	59	Cup forceps	74
Cause set	60-61	Curette	74
Marquet micro instruments	62	Elevator	74
Austin micro instruments	63	Hook	74
Guilford-Wright, Shea micro instruments	64	Knife	74
Hough micro instruments	65	Scissors	74
Jordan micro instruments	66	Bipolar forceps	75
Thomassin set	67-68	Curved self-retaining retractor	75
Double elevator	67	Stainless steel cup, tray	76
Hook - Raspatory	67	Cup	76
Angled suction tube	68	Sterilization tray	76
Cup forceps	68	Stainless steel sterilization tray and case	77
Forceps, serrated jaws	68	Aluminum and plastic sterilization case	78
Sterilization case	68	Numerical index	81
Sterilization tray	68	Table for corresponding manufacturer part numbers	
Suction tube adapter	68	For information purposes only	85
Presutti set for endoscopic surgery of the ear	69-70		
Curved curette double-ended	69		
Lancet knife	69		
Sterilization case	69		
Sterilization tray	69		
Suction tube elevator	69		
Alligator forceps	70		
Fascia press	70		
Suction tube with finger control	70		
Wire crimper forceps	70		
Otoneurosurgery	71-73		
Blunt eyes suction tube	71		
Suction irrigation tube with finger control	71		
Suction tube with finger control	71		
Micro forceps	72		
Micro scissors	72		
Self-retaining retractor	72		
Ball seeker	73		
Curved elevator	73		
Fenestrated curette	73		
Hook	73		
Knife	73		
Micro pick	73		
Raspatory	73		

Integra Limited Warranty

Please refer to the warranty included in the packaging of each product to know the applicable warranty.

Contacts Customer service:

International

+33 (0) 4 37 47 59 50
+33 (0) 4 37 47 59 25 (fax)
csemea@integralife.com

France

+33 (0) 4 37 47 59 10
+33 (0) 4 37 47 59 29 (Fax)
custservfrance@integralife.com

Belgium & Luxembourg

+32 (0) 2 257 4130
+32 (0) 2 253 2466 (Fax)
custsvcbenelux@integralife.com

United Kingdom

+44 (0) 1264 312 725
+44 (0) 1264 312 821 (Fax)
custsvcs.uk@integralife.com

Netherlands

+31(0) 852 083 167
+31(0) 207 093 627 (Fax)
custsvcnetherlands@integralife.com

Italy

+39 (0) 2 577 8921
+39 (0) 2 575 113 71 (Fax)
custsvcitaly@integralife.com

MicroFrance® ENT Instrumentation

INDICATIONS

- All the medical devices showed in this catalogue have indications for diagnosis and/or ENT surgery.
- Sizes are not contractual and are given for information purposes only.

CONTRAINDICATIONS

- Do not use in indications other than the indications mentioned in the DFU or Labeling.

How to read the catalogue

Instrument to a 1/1 scale except mentioned otherwise

Explanatory table see below

Micro crochets mousses 90°			Micro crochet mousse 45°	Porte-coton bout torsillé 120mm	Sonde stylet caudé à plaque protège-auriculaire
MCO805	MCO805A	MCO806	MCO807	7719-2	7731
2mm	2,5mm	0,8mm	1mm	Ø 1,2mm	longueur utile 80mm

DOCUMENT DESTINÉ À L'EUROPE, AU MOYEN-ORIENT ET À L'AFRIQUE. 3

Explanation of the table reference and complementary product description

Title or subtitles	
Global complementary description	
Product ref.1	complementary description 1
Product ref.2	complementary description 2

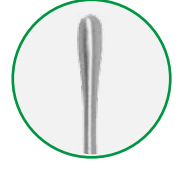
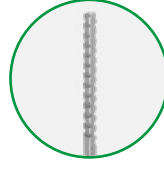
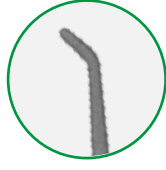

Marquet

Legent



Micro blunt hook
90°

Micro blunt hook
45°

Cotton carrier, twist end
15mm

Angled stilet probe
caustic holder

165mm

165mm

140mm

110mm

MCO805 **MCO805A** **MCO950**

MCO807

7719-2

7731

2mm 2.5mm 0.8mm

1mm

Ø 1.2mm

working length 80mm

Billeau

Snellen

Trautmann

Saint-Paul



Oval loop

160mm	140mm	200mm	170mm	90mm
7718	7885	7885A	7888	7886
4mm	4.5mm	4mm	4mm	2.5mm



Picture for information, without scale

Stainless steel kidney bowl

7875^{(D)*}

^(D) Distributed by Integra MicroFrance SAS (France) - For corresponding manufacturer part numbers, see table in annex.

* Please check with your sales representative availability of this product in your country.

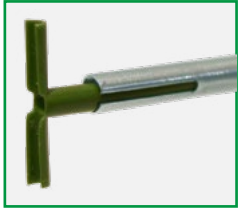

T-tube® 12mm inserter

MCO781

Working length 95mm

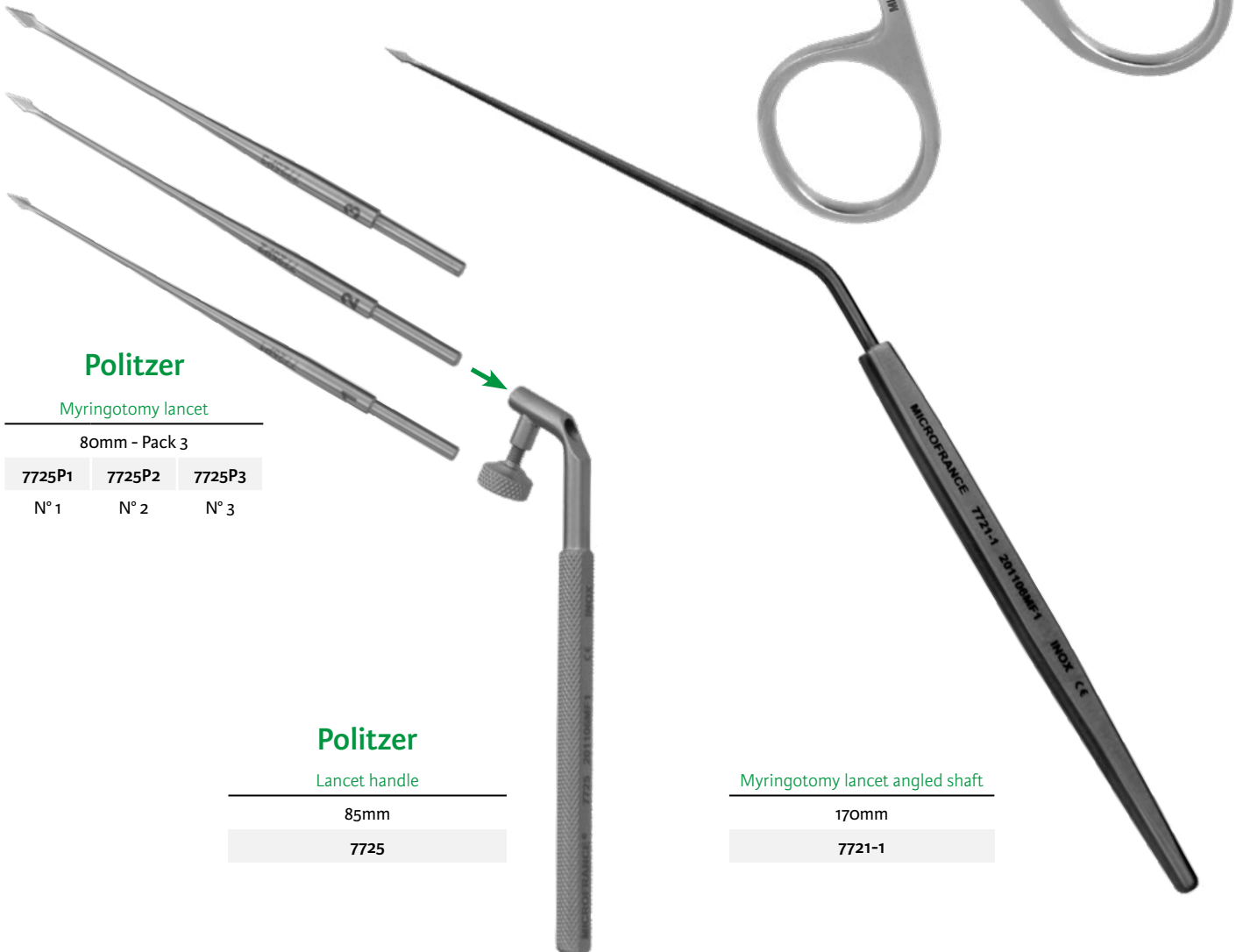

Politzer

Myringotomy lancet

80mm - Pack 3

7725P1	7725P2	7725P3
N° 1	N° 2	N° 3

Politzer

Lancet handle

85mm

7725

Myringotomy lancet angled shaft

170mm

7721-1



Myringoplasty double knife 2x3mm 165mm

3722151

3722150

90° et 115°

3722151

25° et 45°

Scalpel handle, non sterile



Knife blade, sterile, disposable, Pk 25



^(D) Distributed by Integra MicroFrance SAS (France) - For corresponding manufacturer part numbers, see table in annex.
* Please check with your sales representative availability of this product in your country.



120mm

160mm

200mm

150mm

120mm

1003IG^{(D)*}

1005I^{(D)*}

1003LI^{(D)*}

CP821

1004IG^{(D)*}

N° 3

N° 7

N° 3L

N° 4

use with blades 11/15

blades 23

^(D) Distributed by Integra MicroFrance SAS (France) - For corresponding manufacturer part numbers, see table in annex.

* Please check with your sales representative availability of this product in your country.

Le Mée



45mm

Legend



40mm

Diameter	45mm Pack 1, unit	Pack 1, unit	Pack 100, non sterile, individual packaging
2mm	9913-1 ^{(D)*}	-	-
2,5mm	9913-2 ^{(D)*}	-	-
3mm	9913-3 ^{(D)*}	8812-1	8814T1
4mm	9913-4 ^{(D)*}	-	-
4,5mm	-	8812-2	8814T2
5mm	9913-5 ^{(D)*}	8812-3	8814T3
5,5mm	-	8812-4	8814T4
6mm	9913-6 ^{(D)*}	8812-5	8814T5
7mm	9912-7 ^{(D)*}	-	-
8mm	9912-8 ^{(D)*}	-	-
9mm	9912-9 ^{(D)*}	-	-

^(D) Distributed by Integra MicroFrance SAS (France) - For corresponding manufacturer part numbers, see table in annex.

* Please check with your sales representative availability of this product in your country.



Hartmann

160mm

7898

Tieck-Halle



130mm

7897

Beckman



140mm

7899

Left hand

Vienna



140mm

MCO233

Dilator



140mm

MCO237

self-retaining
serrated blades

Tension arm

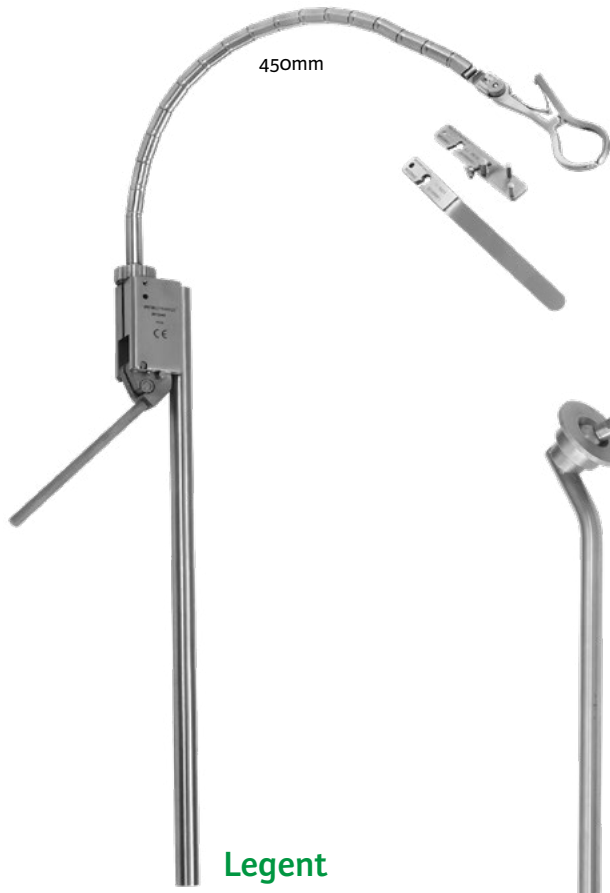

Legent

Flexible tension arm, complete

MCO980

delivered with MCO981



Darrouzet

Flexible tension arm

MCO978

delivered with MCO978S

Table clamp

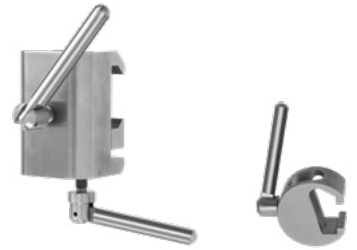

CEV984

CEV985

Accessories for tension arm



Ear quick-lock speculum

MCO981



Articulated kneecap

MCO983-4



Devèze

Self-retaining speculum

MCO981D



MCO978S

Lucae



7726MF

150mm

7726MF	7727	7728
serrated jaws 1x12mm	spoon jaws	1x2 teeth

Politzer



7732-1

120mm

7732-1	7733	7734
serrated jaws 1,5x14mm	spoon jaws	1x2 teeth

Syringe luer-lock high pressure 5cc



Génia

Syringe 5cc

779MF-5CC



Silicone grey washer luer

779MF-2

Pack 6



Replacement tube

779MF-3



Silicon white washer piston

779MF-1

Pack 6



Sébileau

Fleury

Freer

Howarth

Cottle

McKenty



190mm

CP985

5mm



180mm

MCO305

8.5mm



160mm

MCO803

2.5mm



185mm

CP611

5mm



220mm

CP625



220mm

CP626



240mm

CP627

Farabeuf

Fleury

Sébileau

Plester



150mm

7787-10

10mm



170mm

MCO979

6,5mm



150mm

CP825

4mm



180mm

MCO988

7,5mm



195mm

3724059

6,5mm

Farabeuf



120mm	140mm
7768	7768-1
Pack 2	Pack 2

Desmarres



140mm
CP822-12
12mm
CP822-10
10mm
CP822-14
14mm

Gillies



180mm
CP17
3mm
CP17-1
2mm

Gillies



145mm
CP17-3
2mm
CP17-2
3mm



145mm
CP628
5mm

Humby



110mm
CP941
articulated

Knapp



150mm

3714027

8mm

3714028

blunt

Volkmann



140mm

CP21-3

sharp

CP21A-3

blunt



150mm

7782-1-2



180mm

CP335



160mm

CP609

3 sharp prongs

Weitlaner

110mm

0-28-8



Schuknecht

130mm

0-28-2



Weitlaner-Wullstein

130mm

0-28-1



Weitlaner

130mm

0-28

3x4 sharp prongs

Self-retaining retractor with blade



Plester

110mm

o-28-3	o-28-4
sharp prongs right	sharp prongs left



Weitlaner

Curved retractor

160mm

O-28-7

sharp prongs

Bizeau

165mm

MCL359

3 blades 20x30mm

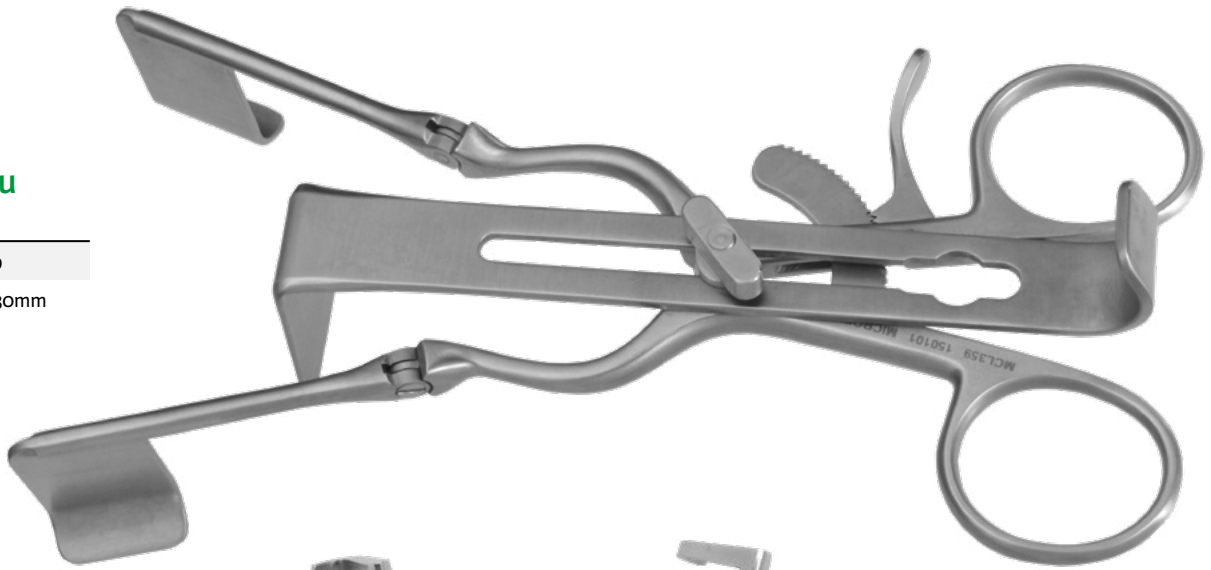

Weitlaner-Beckmann

165mm

7781



Lombard

165mm - 110g

MCO995



185mm - 330g

7766

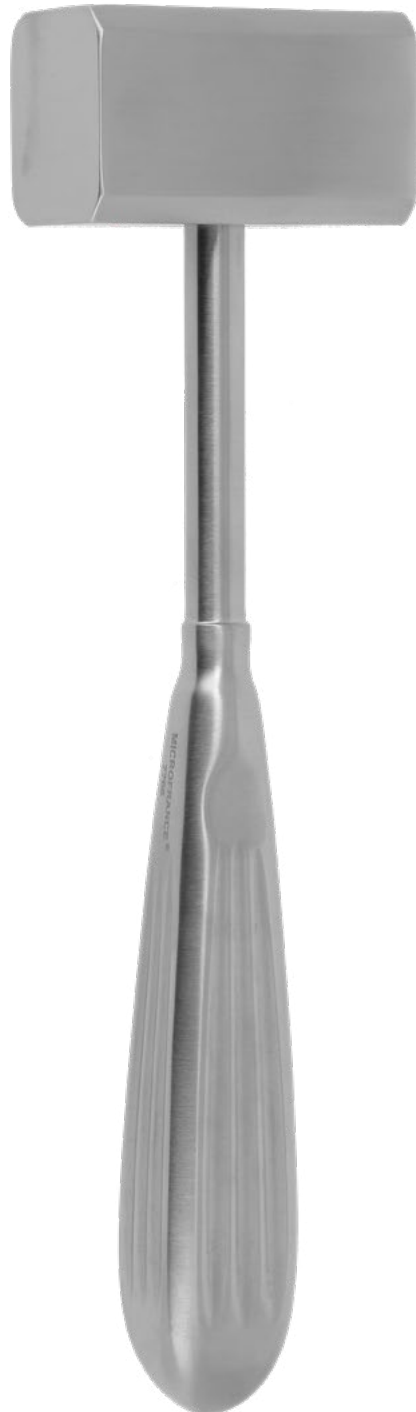

180mm - 200g

CP907

1 teflon head



180mm - 230g

CP300



Jost



180mm



CP801-7 7mm



CP801-10 10mm

Fleury



150mm

CP823-5 5mm



150mm

CP824-5 5mm



130mm



MCO214-13-10 1mm



MCO214-13-20 2mm



MCO214-13-40 4mm



MCO214-13-60 6mm



MCO214-13-80 8mm

Scale 1/2

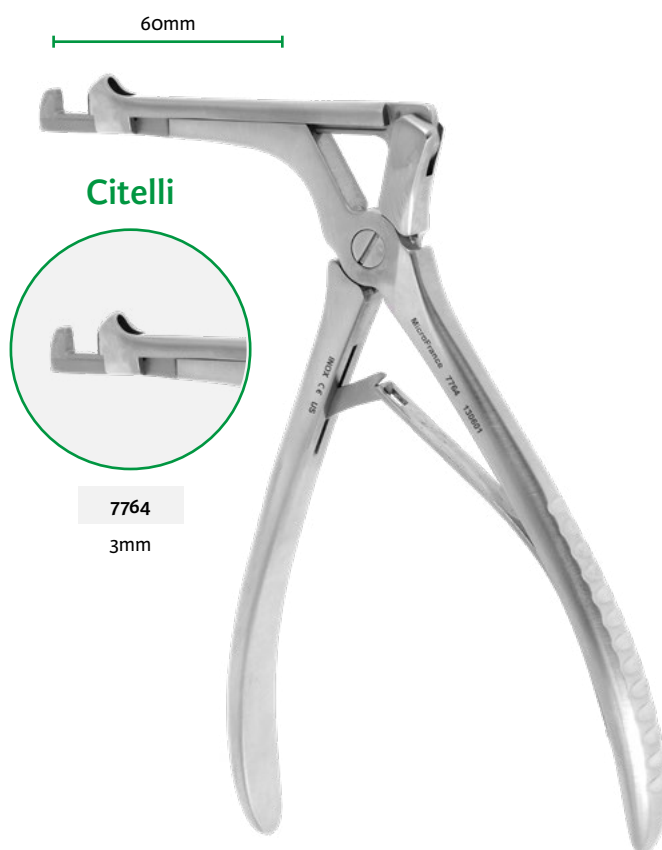



CP380

Beyer

160mm

CP380	CP380-2
straight jaws 2mm	curved jaws 2mm



CP380-3

Beyer

180mm

CP380-3	CP380-5	CP380-1
curved jaws 2mm	curved jaws 4mm	straight jaws 2mm

Streiff

105mm

CP16-1	CP16
curved blades	straight blades



100mm

CP353
strong curvature



Offret

100mm

CP356



Joseph

120mm

CP354A	CP354
curved blades	straight blades

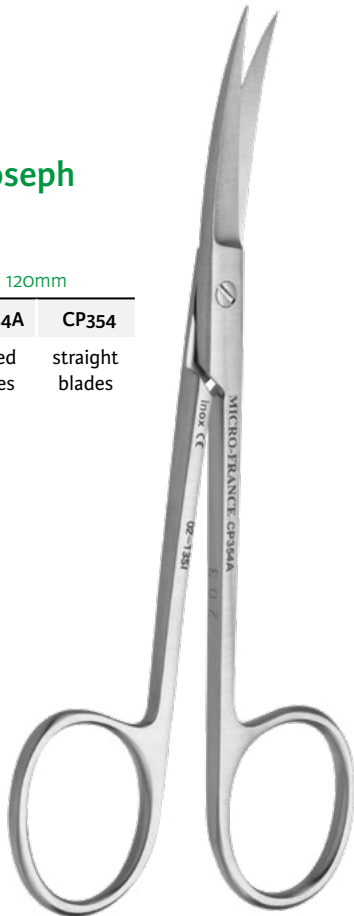

Joseph

110mm

CP919A	CP919
curved blades	straight blades



Fox

110mm

CP358A	CP358
curved blades	straight blades



Shea

120mm

CP637

curved blades



Bregeat

110mm

CP363

curved blades



Stevens

110mm

CP922A

curved blades
Tenotomy

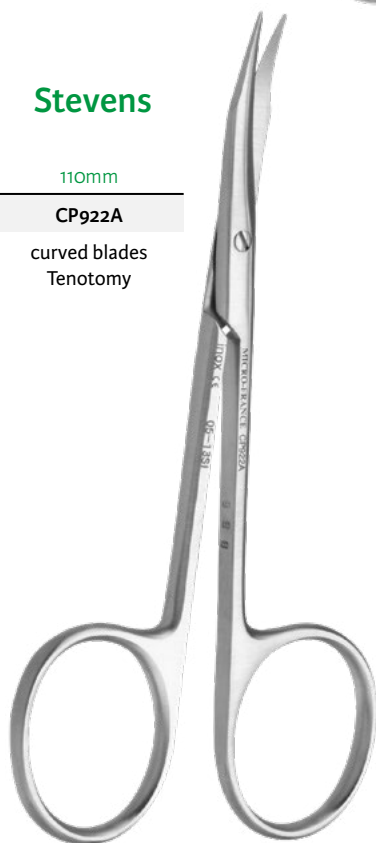

Stevens

110mm

CP922

straight blades
Tenotomy



Stevens

115mm

CP922B

curved blades
Tenotomy

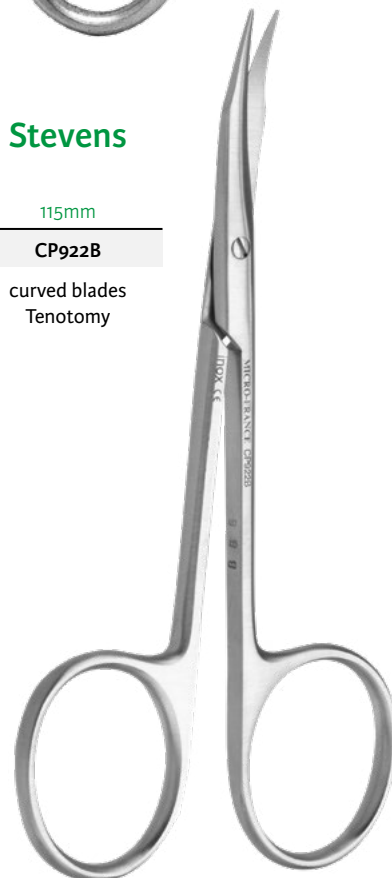

Metzenbaum

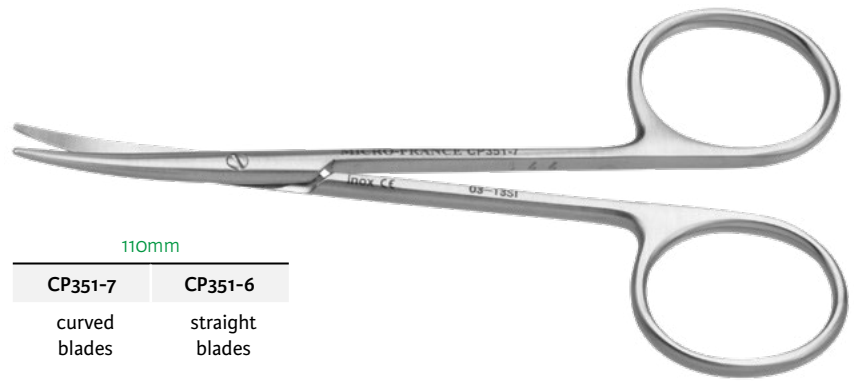

110mm

CP351-7	CP351-6
curved blades	straight blades

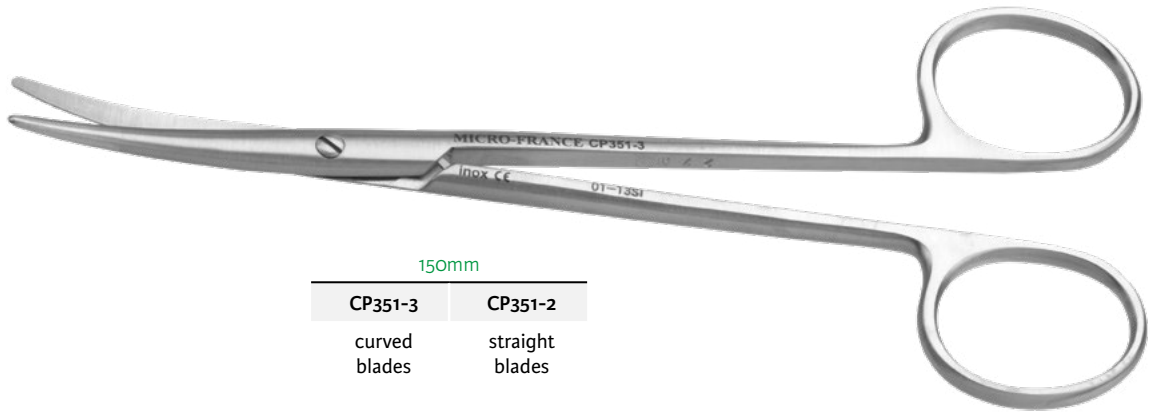

150mm

CP351-3	CP351-2
curved blades	straight blades

Delicate blades

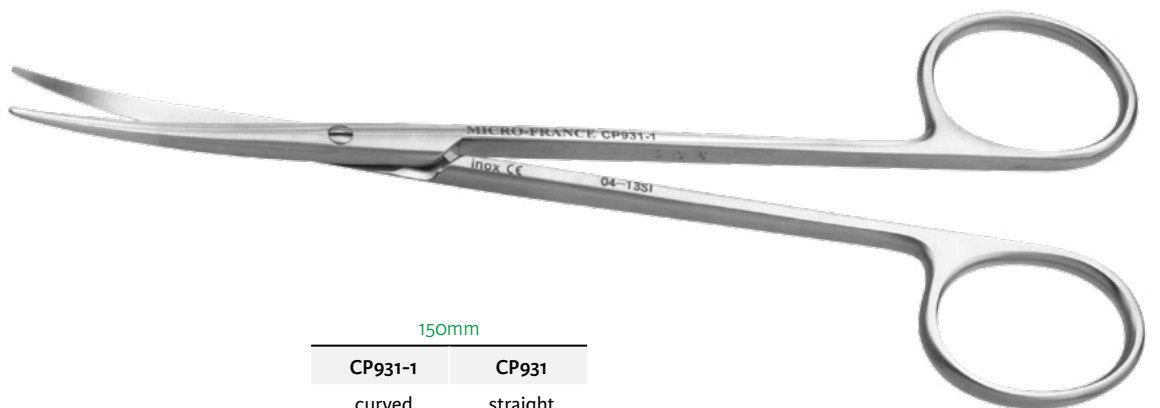

150mm

CP931-1	CP931
curved blades	straight blades

Mayo



170mm
CP352-2
straight blades

150mm
CP352
straight blades

170mm
CP352-3
curved blades

150mm
CP352-1
curved blades

Dissecting forceps 110mm

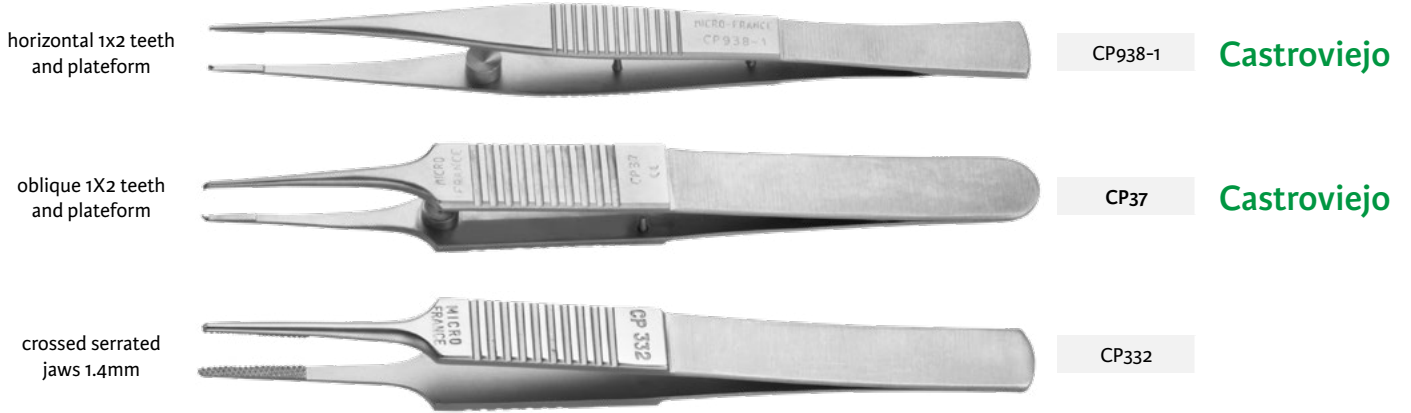

Dissecting forceps 120mm

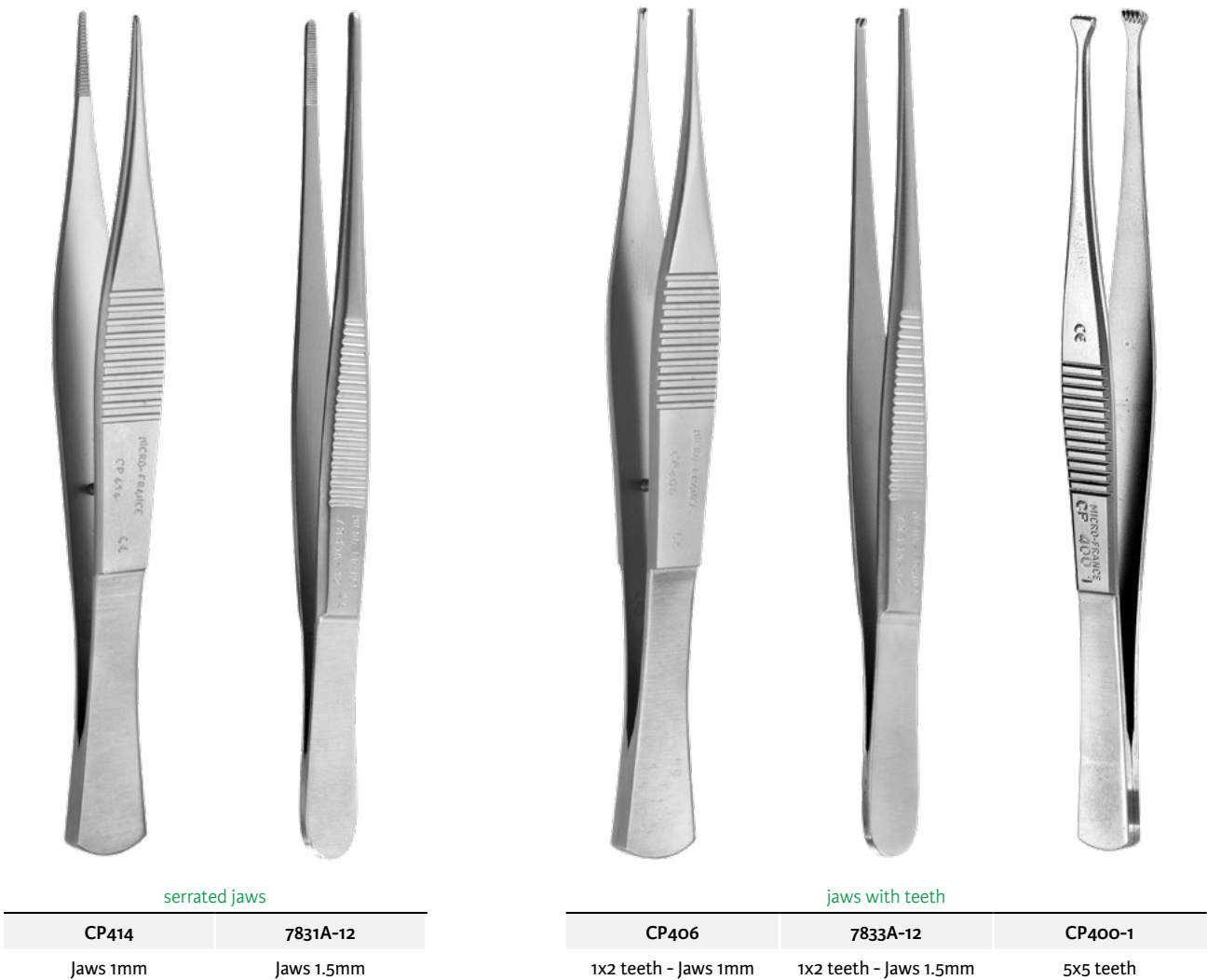

150mm

Adson



- CP604-15 serrated jaws 1.5mm
- CP605-15 1x2 teeth 1.5mm

Adson-Brown



- CP606-15 7x7 teeth

120mm



Adson-Tubiana

Adson

Adson-Brown

Jaws 1mm		Jaws 1,5mm		Jaws 1,5mm	7x7 teeth
M832	M833	CP604	CP605	CP606A	CP606
serrated	1x2 teeth	serrated	1x2 teeth	serrated tungsten jaws	

Mac-Indoe

140mm



CP934

oblique
1x2 teeth
and serrated
platform

CP934-1

serrated
jaws

Debakey

Barraya

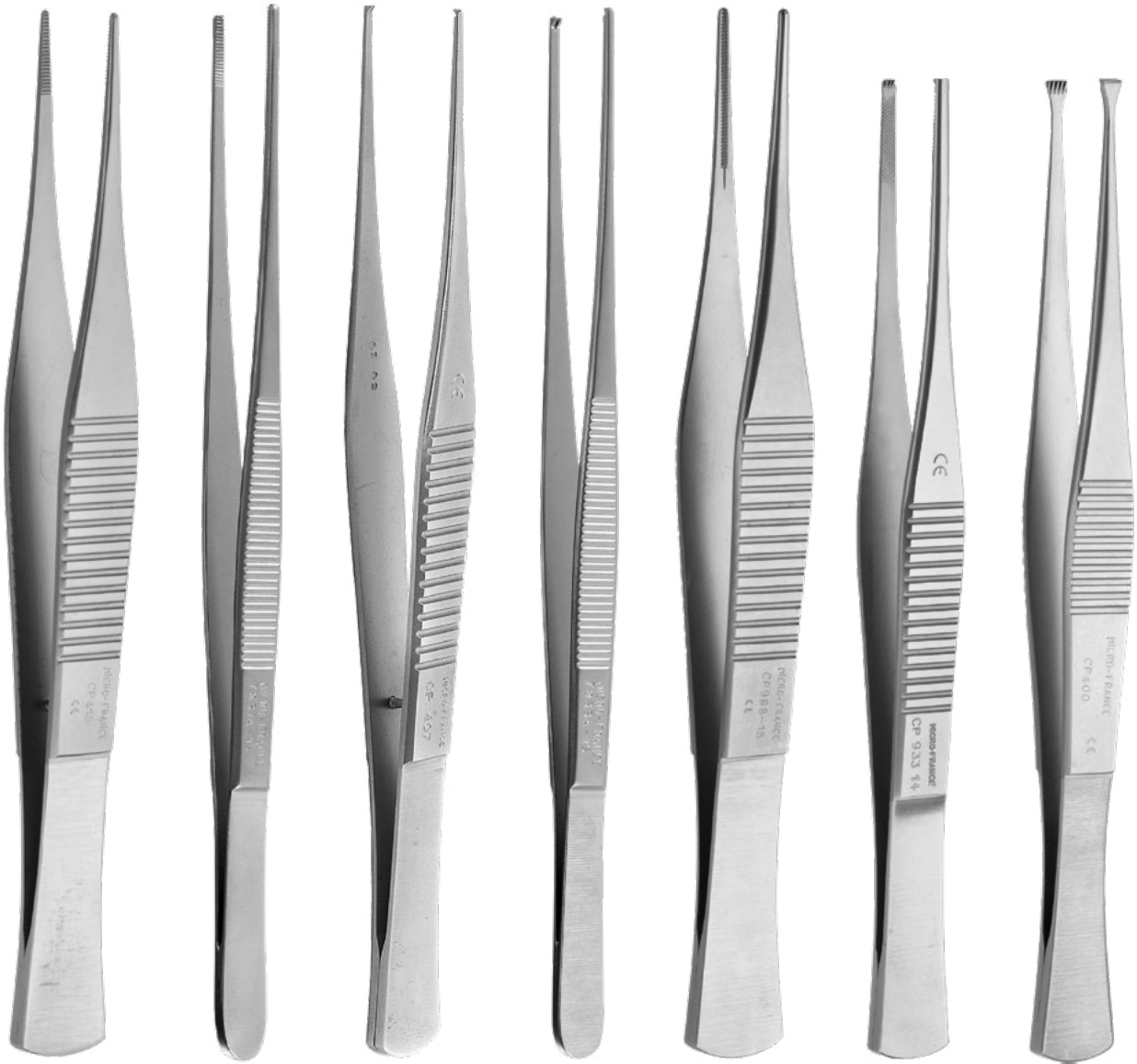

150mm

140mm

CP415	7831A-15	CP407	7833A-15	CP988-15	CP933-14	CP400
serrated jaws 1mm	serrated jaws 1.5mm	1x2 teeth jaws 1mm	1x2 teeth jaws 1.5mm	jaws 1.5mm	3x4 teeth and serrated platform	5x5 teeth



Magnan



Adson



110mm		120mm		160mm		200mm	
CP392-1R	CP604BR	CP605BR	CP392-2R	CP392-8R	CP392BI	CP392BS	
Smooth jaws 1x8mm	Serrated jaws 1.5mm	1x2 teeth 1.5mm	Smooth jaws 1x8mm	Smooth jaws 1x8mm	Smooth jaws 0.5x5mm	Smooth jaws 0.5x5mm	

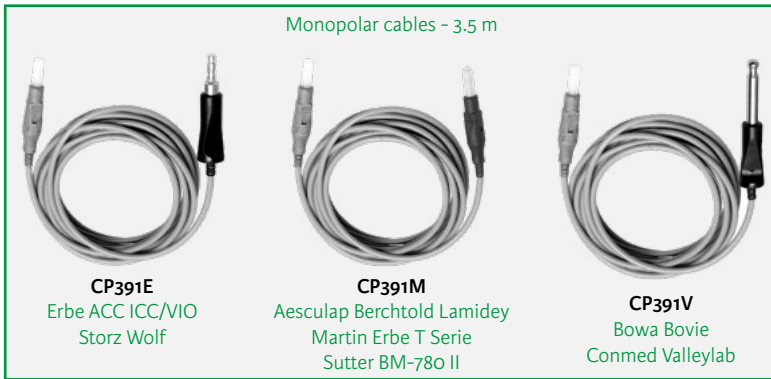

Adson



110mm

CP390-1
Smooth jaws
1x8mm



120mm

CP604M
Serrated jaws
1.5mm



CP605M
1x2 teeth
1.5mm



160mm

CP390-2
Smooth jaws
1x8mm



CP390-8
1x2 teeth
1x8mm

Halsey

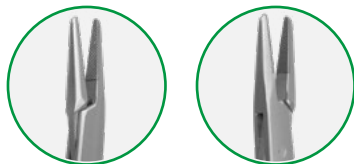

130mm

703T	704T
Serrated jaws	Smooth jaws

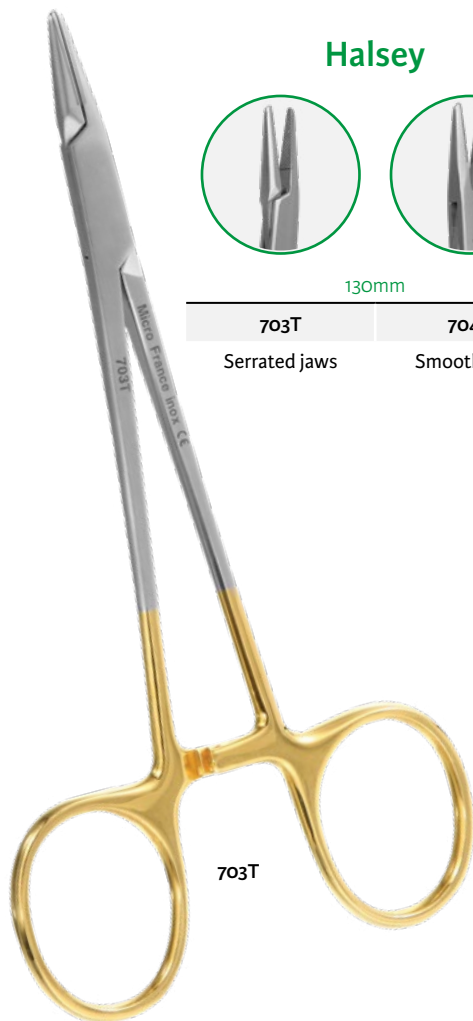

703T

Crile-Wood

Mayo-Hégar

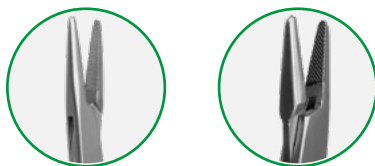

150mm

702T	714T
------	------

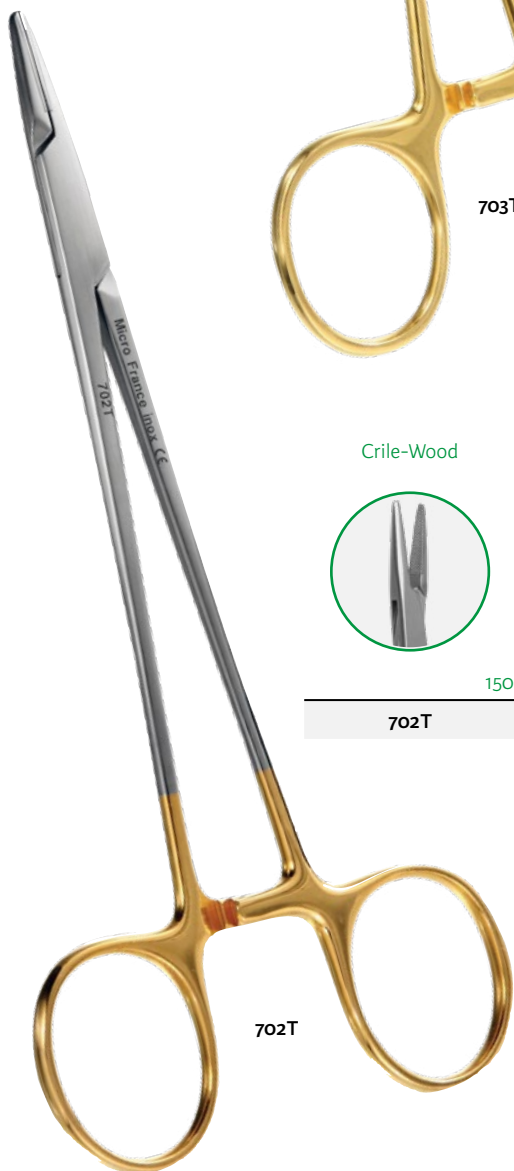

702T

Becker

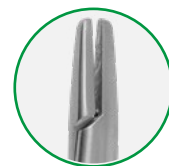

130mm

CP1107
diamond jaws

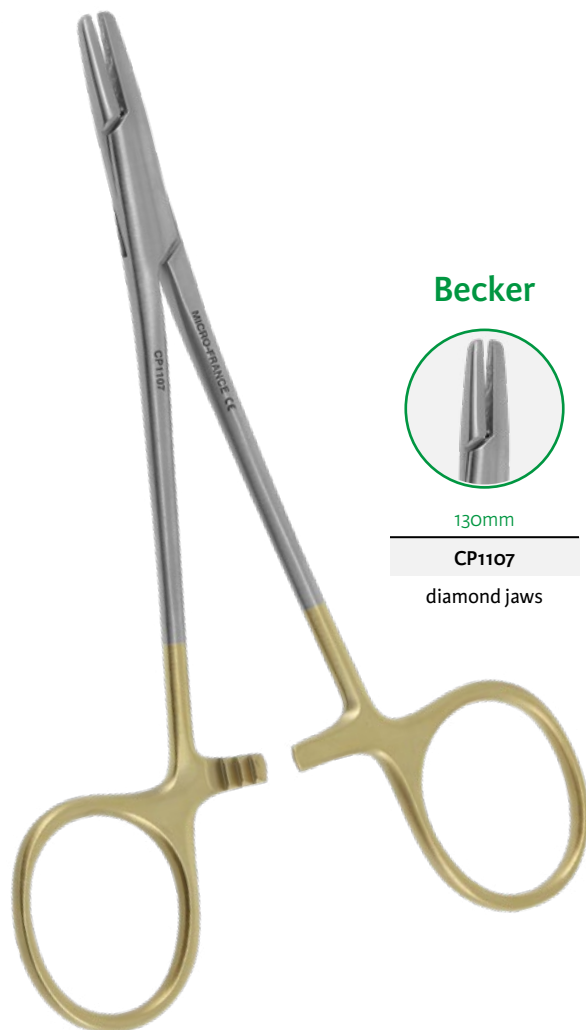

Leriche

140mm - without teeth

7867-1	7867-2
straight	curved

140mm - with teeth

7867-3	7867-4
straight	curved

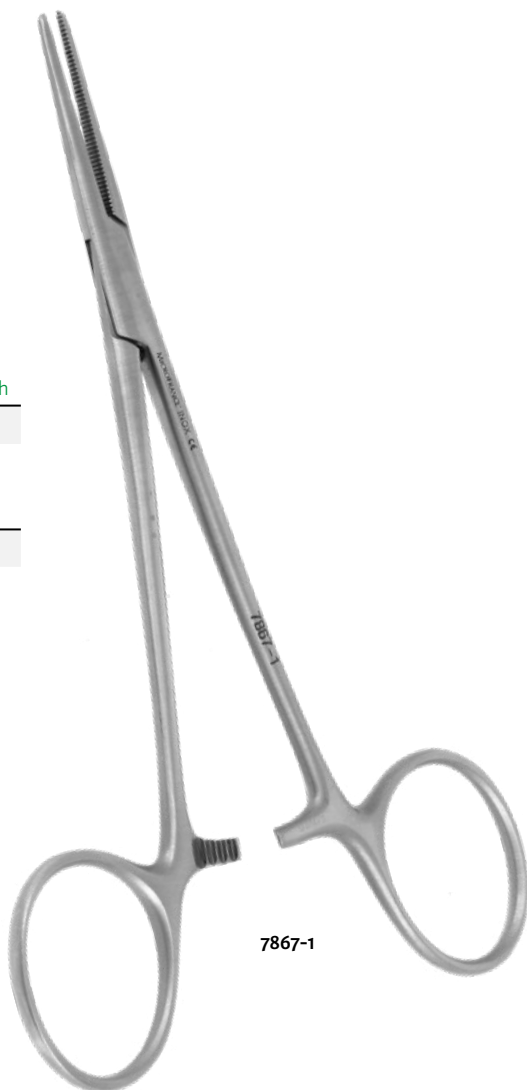

7867-1

Halsted

120mm - with teeth

P761-7	P761-8
straight	curved

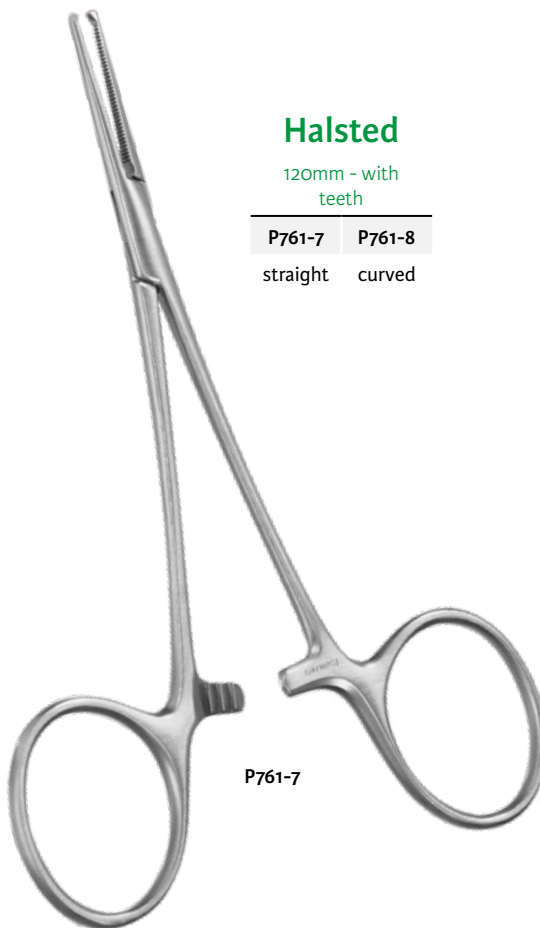

P761-7

Kelly

without teeth

140mm 160mm

P762-2 P762-4

curved curved



P762-2

Kocher

140mm 160mm 180mm

straight without teeth

P764-1 P764-5 -

straight with teeth

P764-3 P764-7 P764-11



P764-3



Martel

130mm

P763

Forceps with teeth
'T' tip



Péan

140mm 160mm

P765-14 **P765-16**

Haemostatic forceps
serrated jaws

P765-14



Terrier

130mm

P769

Haemostatic forceps
serrated jaws



Chaput

130mm

7866-13

2x3
teeth

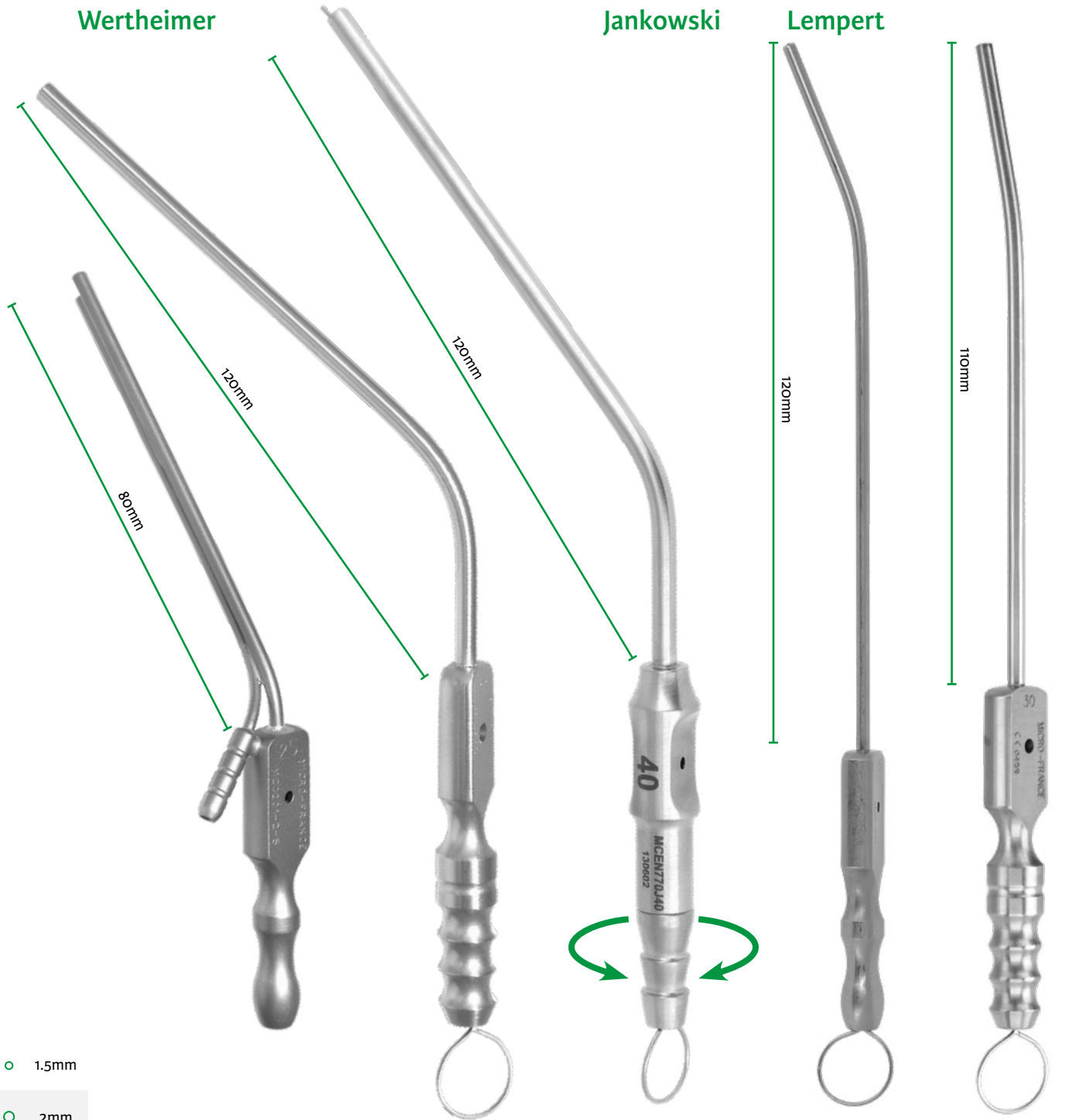

○ 1.5mm

○ 2mm

○ 2.5mm

○ 3mm

○ 3.5mm

○ 4mm

Wertheimer	
MCO201-2-5	2.5mm
MCO201-3-0	3mm

Wertheimer	
MCO770-1-5	1.5mm
MCO770-2-0	2mm
MCO770-2-5	2.5mm
MCO770-3-0	3mm
MCO770-3-5	3.5mm
MCO770-4-0	4mm

Jankowski	
MCEN770J40	4mm
MCEN770J30	3mm

Lempert	
MCO771-2-5	2.5mm
MCO771-3-0	3mm
MCO771-4-0	4mm

Lempert	
CP330-3-0	3mm
CP330-4-0	4mm

Luer-lock adapter

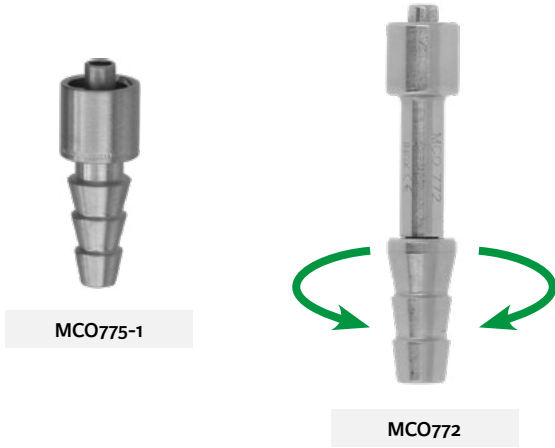

Suction tube adapter with finger control



Benzeth



Micro curved suction tube

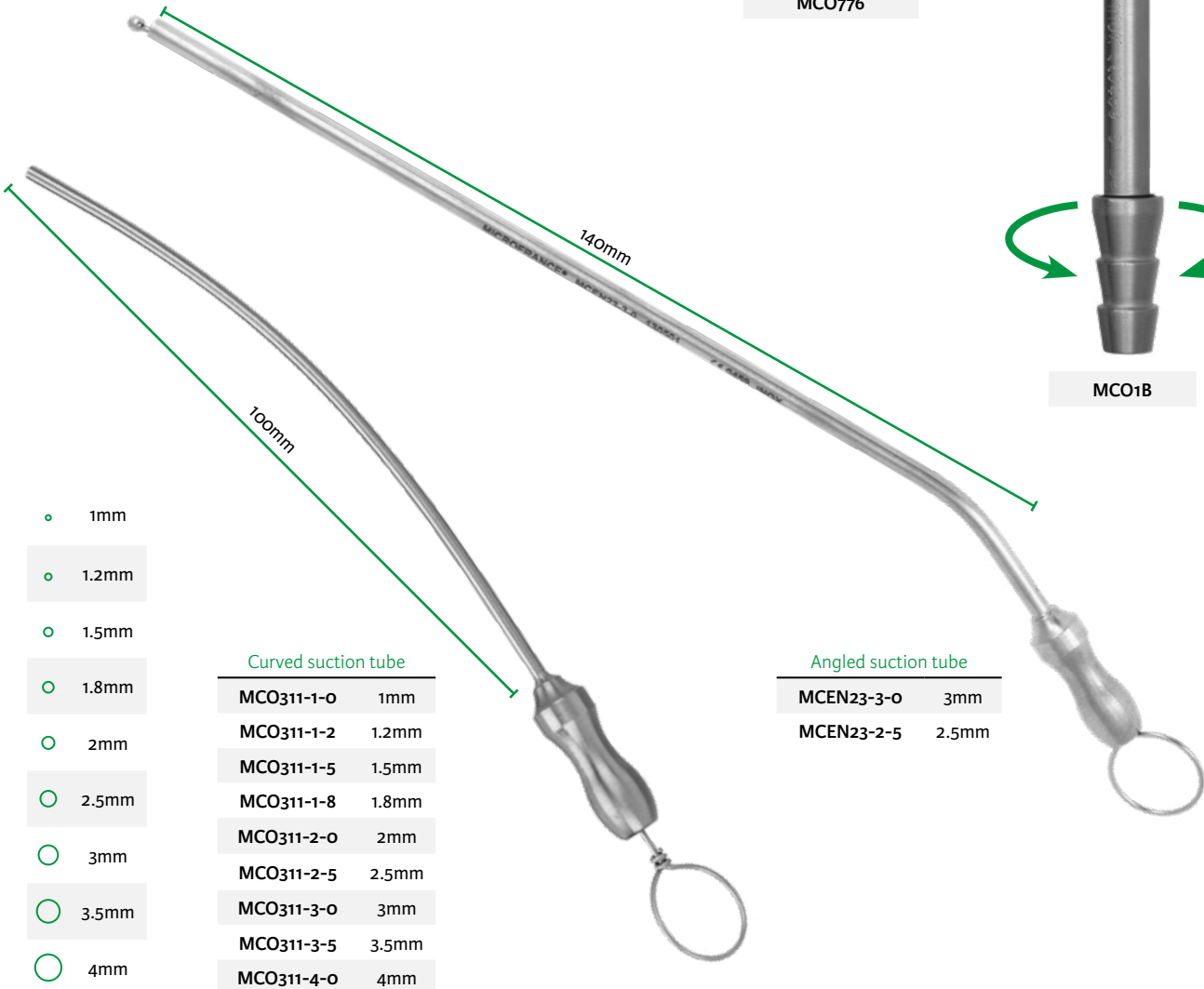

- 1mm
- 1.2mm
- 1.5mm
- 1.8mm
- 2mm
- 2.5mm
- 3mm
- 3.5mm
- 4mm

Curved suction tube

MCO311-1-0	1mm
MCO311-1-2	1.2mm
MCO311-1-5	1.5mm
MCO311-1-8	1.8mm
MCO311-2-0	2mm
MCO311-2-5	2.5mm
MCO311-3-0	3mm
MCO311-3-5	3.5mm
MCO311-4-0	4mm

Angled suction tube

MCEN23-3-0	3mm
MCEN23-2-5	2.5mm

Maspetiol



MCO773

Micro suction tube Ø 2,5 mm

MCO773

with luer-lock connection

Micro suction tube tip
for MCO773

MCO774-0-4	0,4mm
MCO774-0-5	0,5mm
MCO774-0-6	0,6mm
MCO774D8	0,8mm

Charachon



MCO890

Micro suction tube Ø 3mm

MCO890

Micro suction tube tip

MCO890-1-04	0,4mm
MCO890-1-08	0,8mm
MCO890-1-12	1,2mm
MCO890-1-15	1,5mm
MCO890-1-20	2mm

Rosen

Frayse

Causse

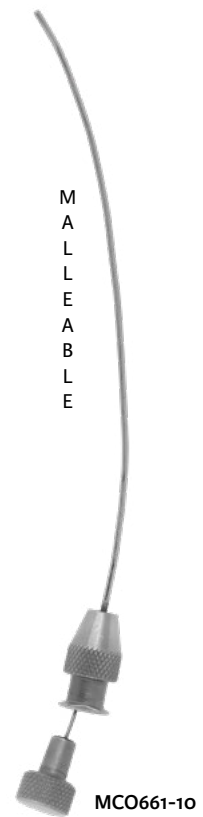

Micro angled suction tube with luer-lock

Pack 3	
MCO3P05	0.5mm
MCO3P07	0.7mm
MCO3P10	1mm
MCO3P12	1.2mm
MCO3P15	1.5mm
MCO3P18	1.8mm
MCO3P20	2mm
MCO3P24	2.4mm

Micro blunt eyes suction tube with luer-lock

MCO366F10	1mm
MCO366F12	1.2mm
MCO366F15	1.5mm
MCO366F20	2mm

Micro malleable suction tube with luer-lock

MCO661-10	1mm
MCO661-7	0.7mm

Hartmann

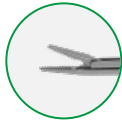

MCO13C
0.6x3mm



MCO13A
4.5x1mm



MCO17
4x0.8mm
Right opening



MCO13D
6x1.3mm



MCO22
6x1.5mm
1x2 teeth



MCO13B
8x1.6mm



MCO13E
0.9x12mm

70mm

Marquet



MCO960
0.6x3mm



MCO961
0.6x3mm

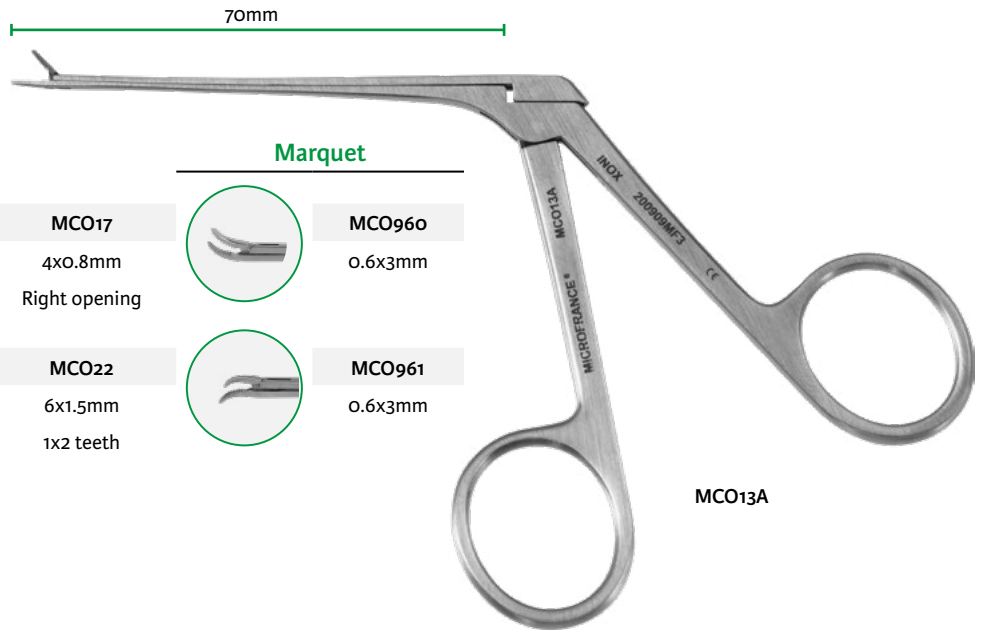

MCO13A

Alligator forceps

100mm



Martin
MCO23A
1.5x8mm

80mm

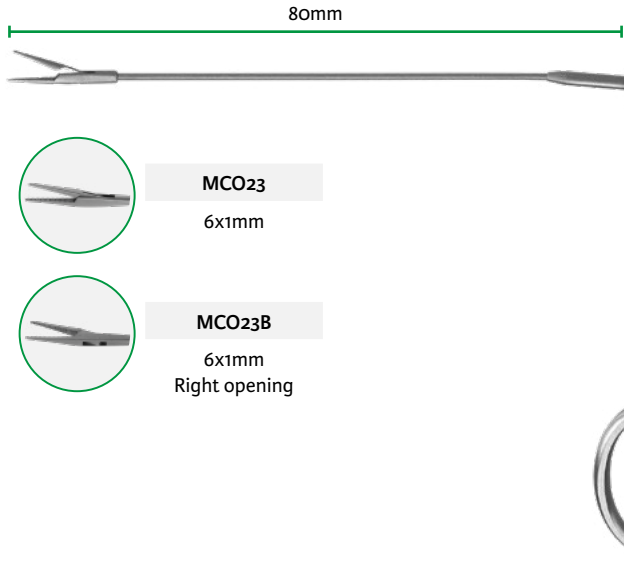

MCO23
6x1mm



MCO23B
6x1mm
Right opening

MCO23A

MCO23

Micro scissors

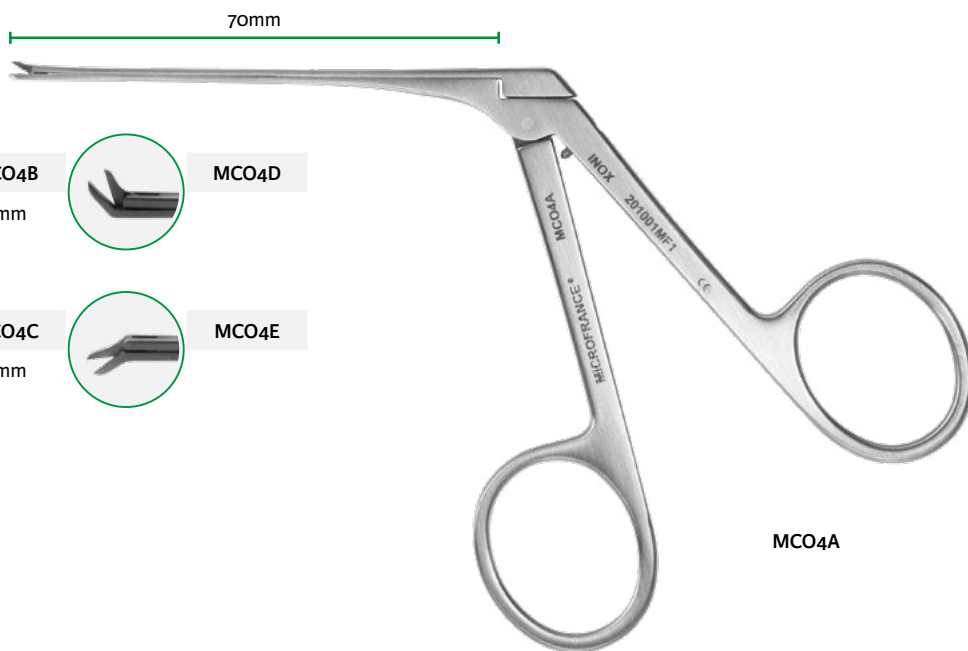
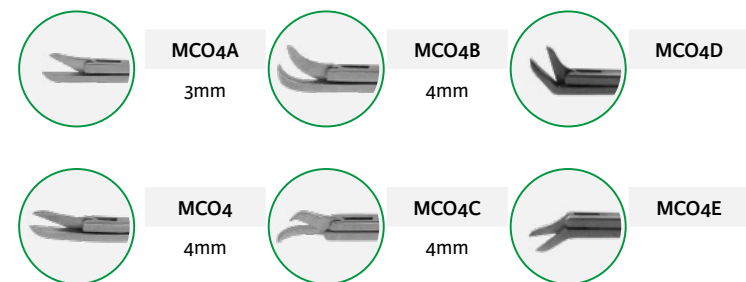

Micro cup forceps

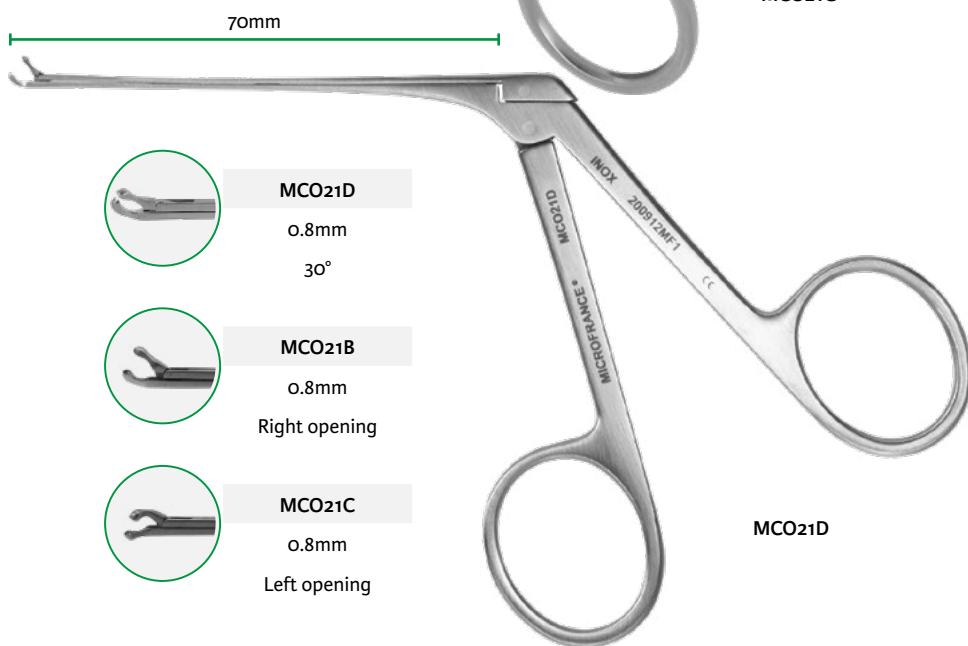
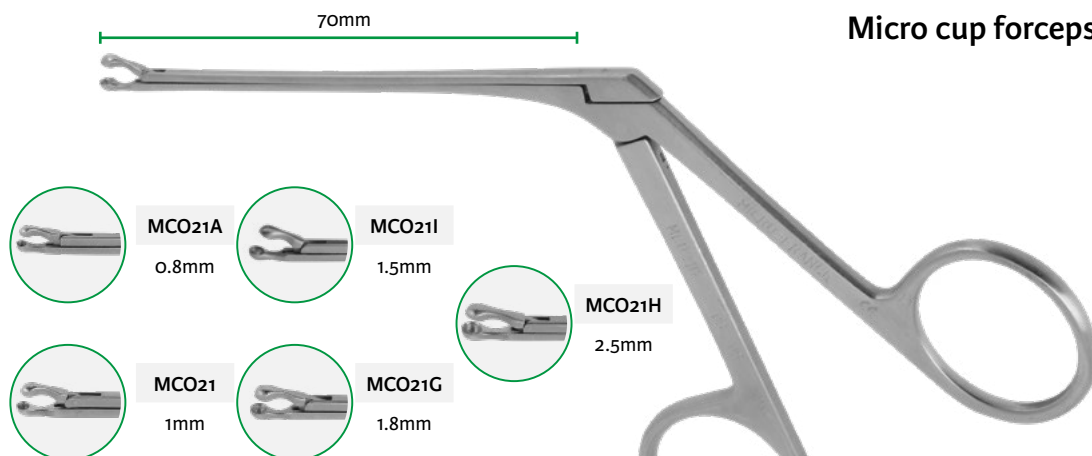

Kraus

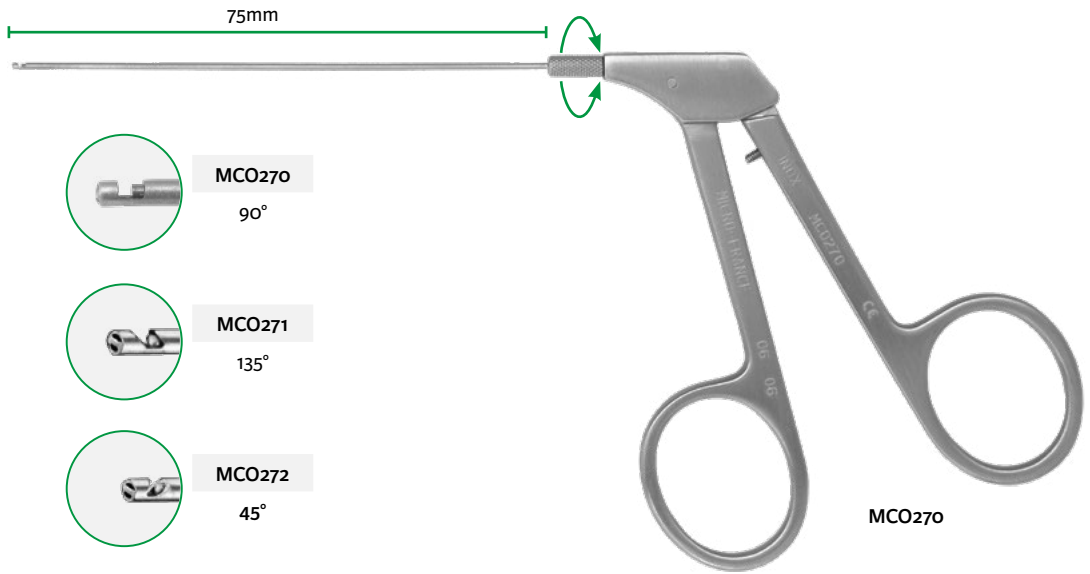

Dieter

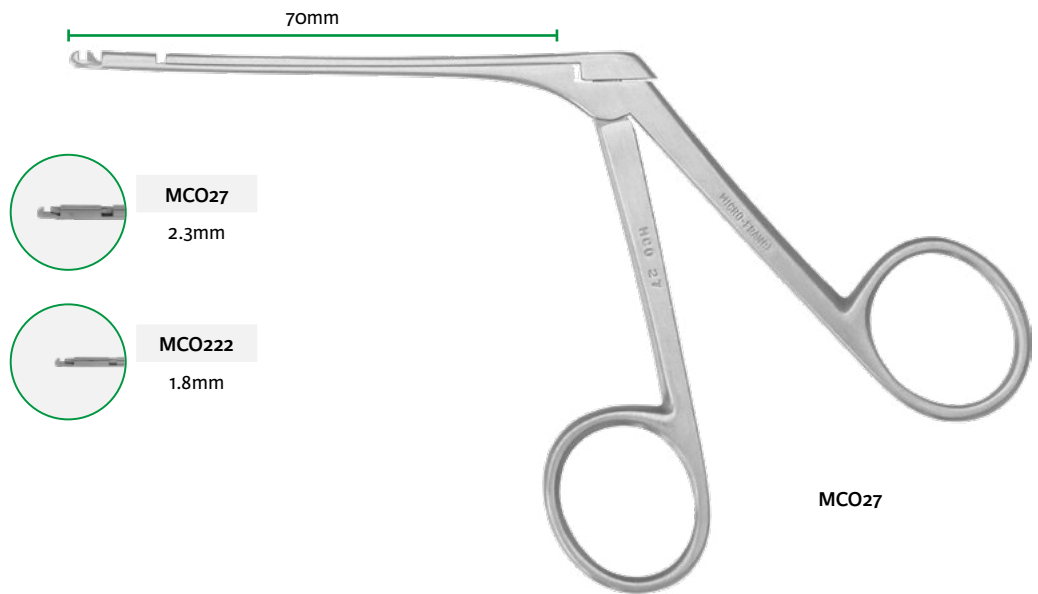

Dieter-Charachon

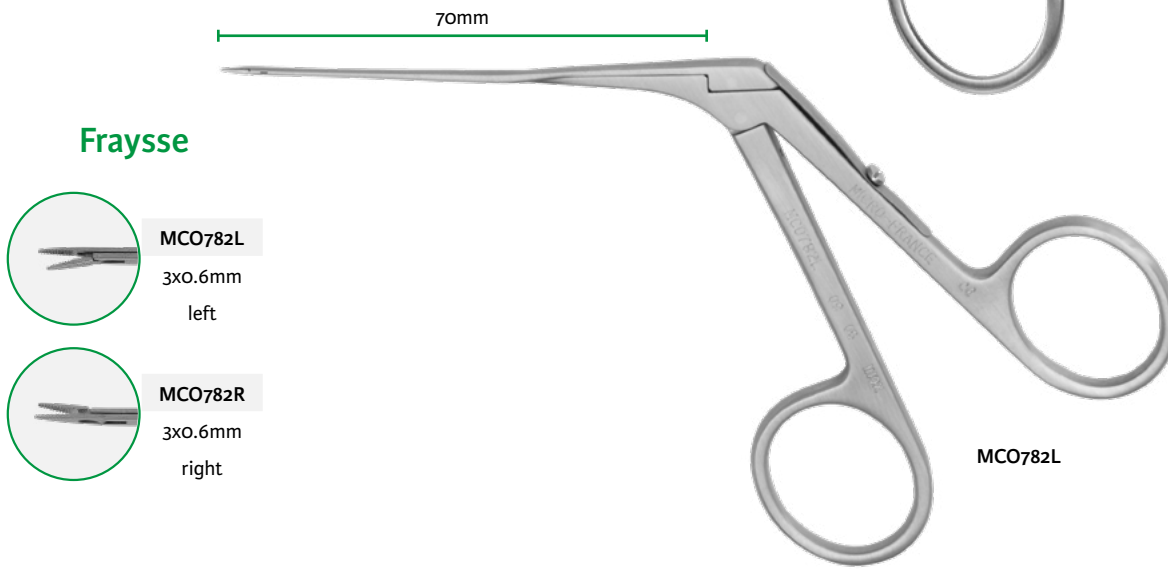
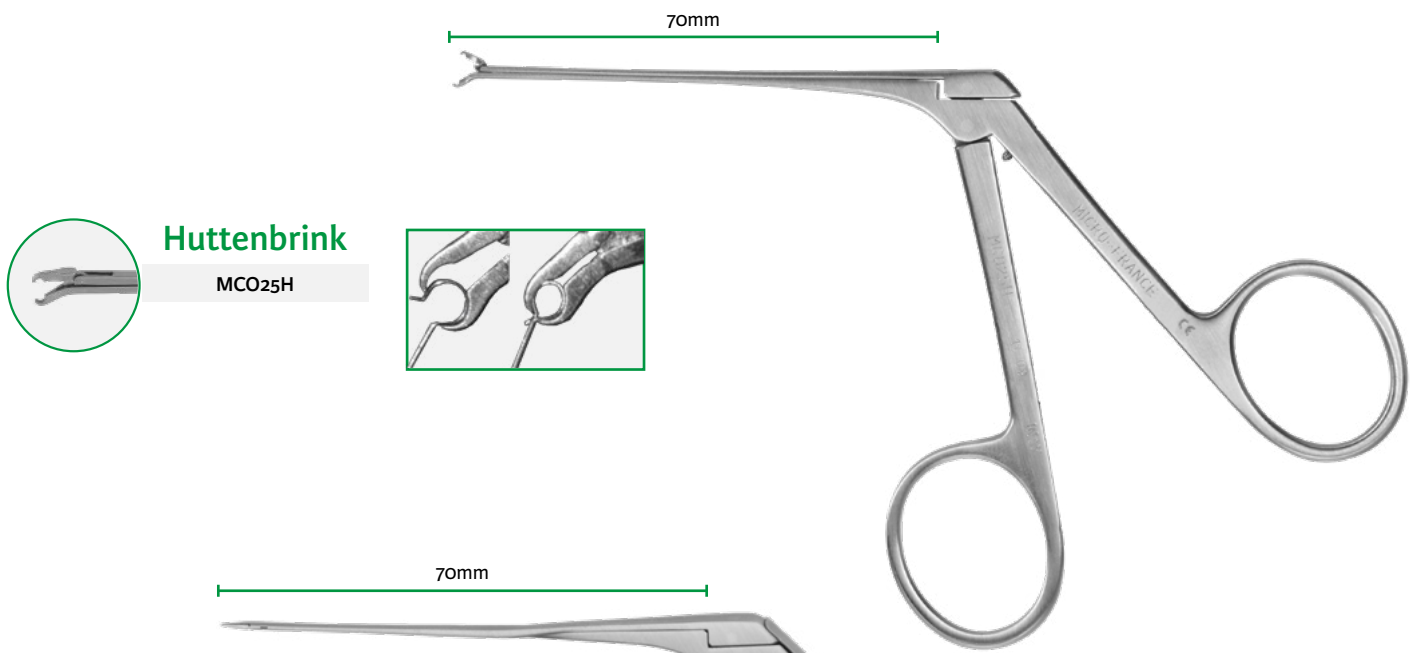
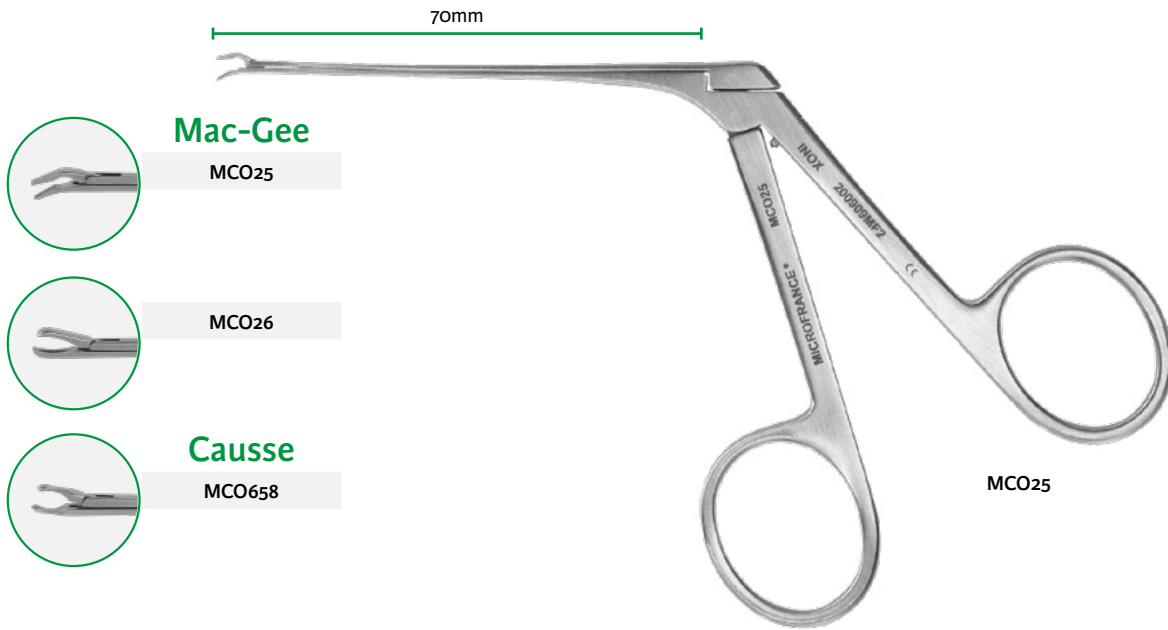



MCO5A-2-5
165mm



Micro knife 45°

Oval knife

Cause

Martin

45°

Rosen

Cause

Plester

MCO5A-2-5	2.5mm	MCO652	MCO215	MCO5C	MCO313	MCO653	MCO6
MCO5A-1-0	1mm	3mm	3mm	2.5mm	1.8x2.5mm	1.5x2mm	2x2.5mm
MCO5A-1-5	1.5mm		knife mirror	angled tip			
MCO5A-2-0	2mm						

Micro sickle knife

Micro lancet knife

Micro straight chisel

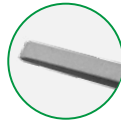

Rosen

Morgon

Jost

MCO10	MCO10B	MCO10M	MCO204C	MCO2
5mm	4.5mm	4mm	2x4mm	1.2mm



MCO650
165mm

Cause

Frayse

Cause

Plester



Tip bent shaft

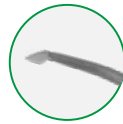
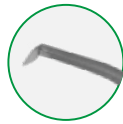

Micro knife

Micro lancet knife

Micro oval knife

MCO5B	MCO650	MCO5	MCO651F	MCO651	MCO6C
30° 2.5mm	90° 3mm	90° 2.5mm	90° 1.5x1.5mm	45° 1.5x2mm	30° 2x2.5mm



MCO5E
165mm
→ Suction



MCO5D
45°
2mm

Micro suction round knife

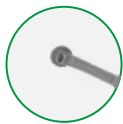

MCO5E
45°
3mm

Josephson



160mm



Sickle knife
3mm

MCO312
Double instrument

Micro knife
45°
1.5x3mm



Micro mirror



Micro raspatory

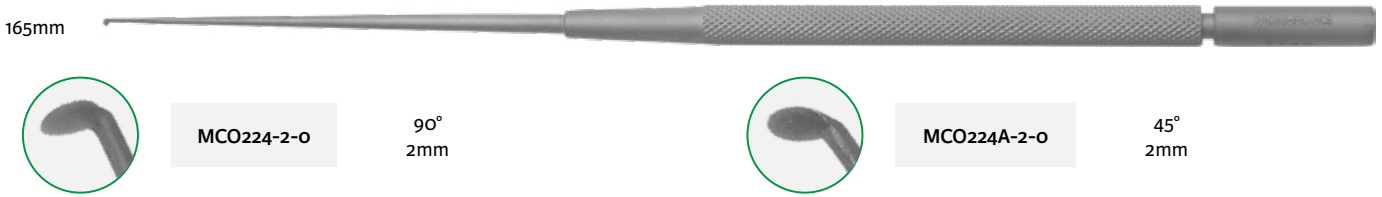

Micro angled elevator

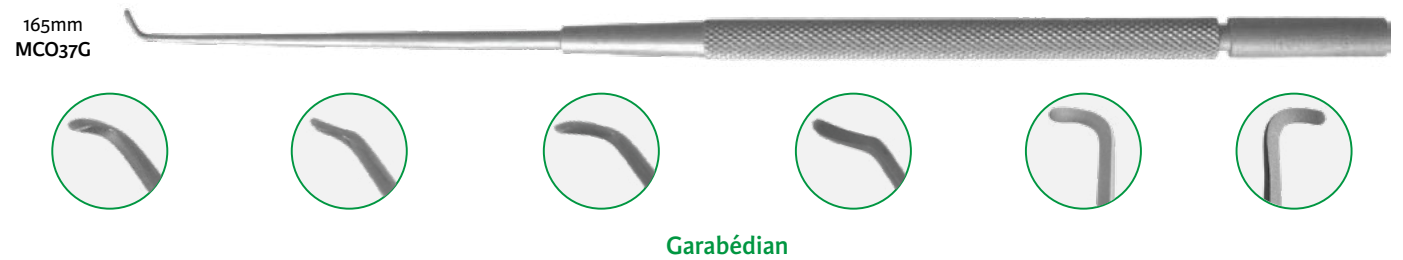

Whirlybird				Angled	
MCO37	MCO37-1	MCO37D	MCO37G	MCO905	MCO906
angled right	angled left	angled right	angled left	angled right	angled left

Micro curved elevator

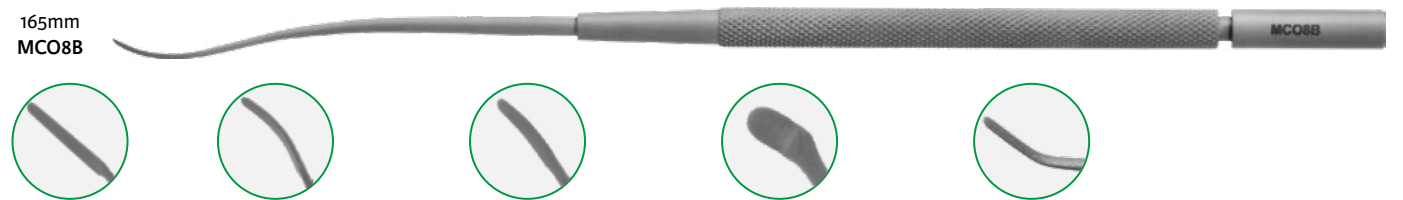

Gimmick			Causse	
angled 15°	curved	Sulcus curved	angled 45°	angled 45°
MCO8	MCO8B	MCO817	MCO667	MCO210
1.5x15mm	1.5x15mm	1.7x7mm	2x3mm	0.75x4mm

Micro double elevator

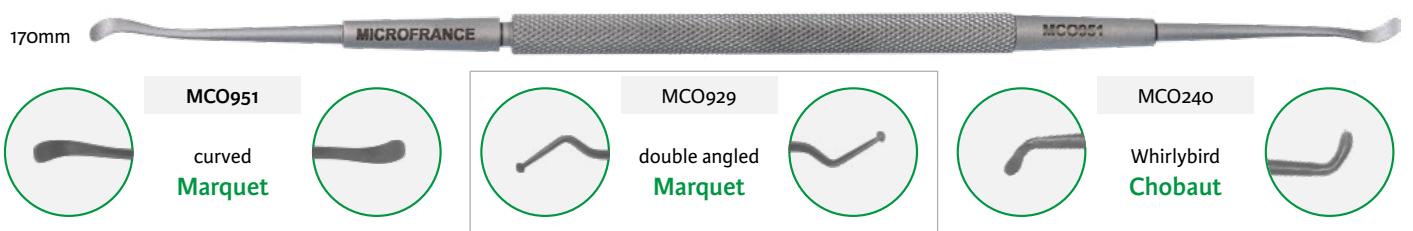

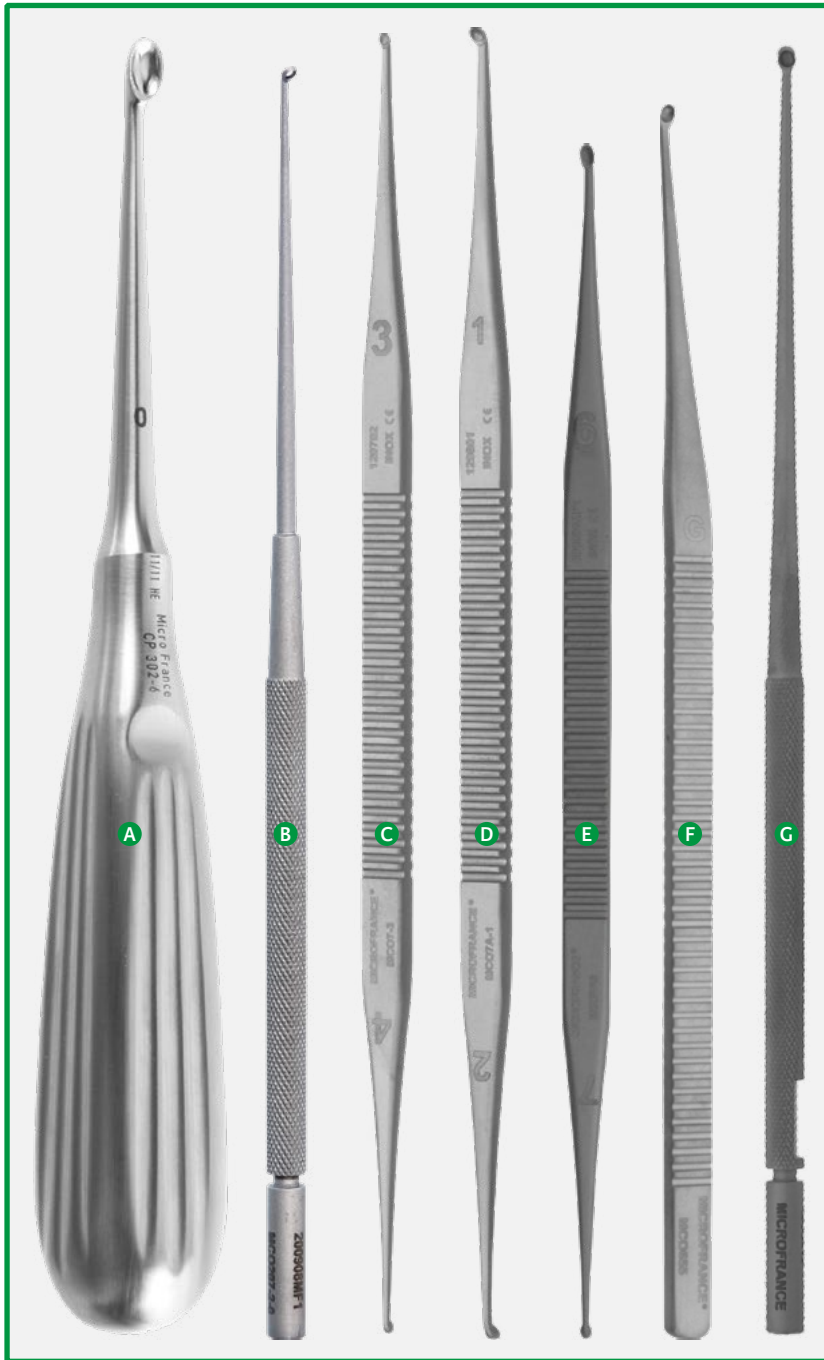

A
Volkman straight curette 170mm

0	CP302-2	2mm
0	CP302-3	3mm
0	CP302-4	4mm
0	CP302-5	5mm
0	CP302-6	6mm
0	CP302-8	8mm

B
Micro fenestrated curette 165mm

	MCO207-1-5	1,5mm
	MCO207-2-0	2mm

C
Micro straight double curette 170mm

	MCO7-1	2,2 / 2,5mm n° 1/2
	MCO7-3	1,5 / 1,9mm n° 3/4

D
Micro angled double curette 155mm

	MCO7A-1	2,2 / 2,5mm n° 1/2
	MCO7A-3	1,5 / 1,9mm n° 3/4
	MCO7A-5	1 / 1,2mm n° 5/6

G
Micro straight curette 170mm

	MCO818	2,5mm
--	--------	-------

E
Micro double curette 155mm

Romanet

	MCO7A6	angled 1,7x3,2 / 1,3x2,3mm
--	--------	----------------------------------

F
Micro angled curette 160mm

Causse

	MCO655	2,8mm 45°
--	--------	-----------

Micro pick

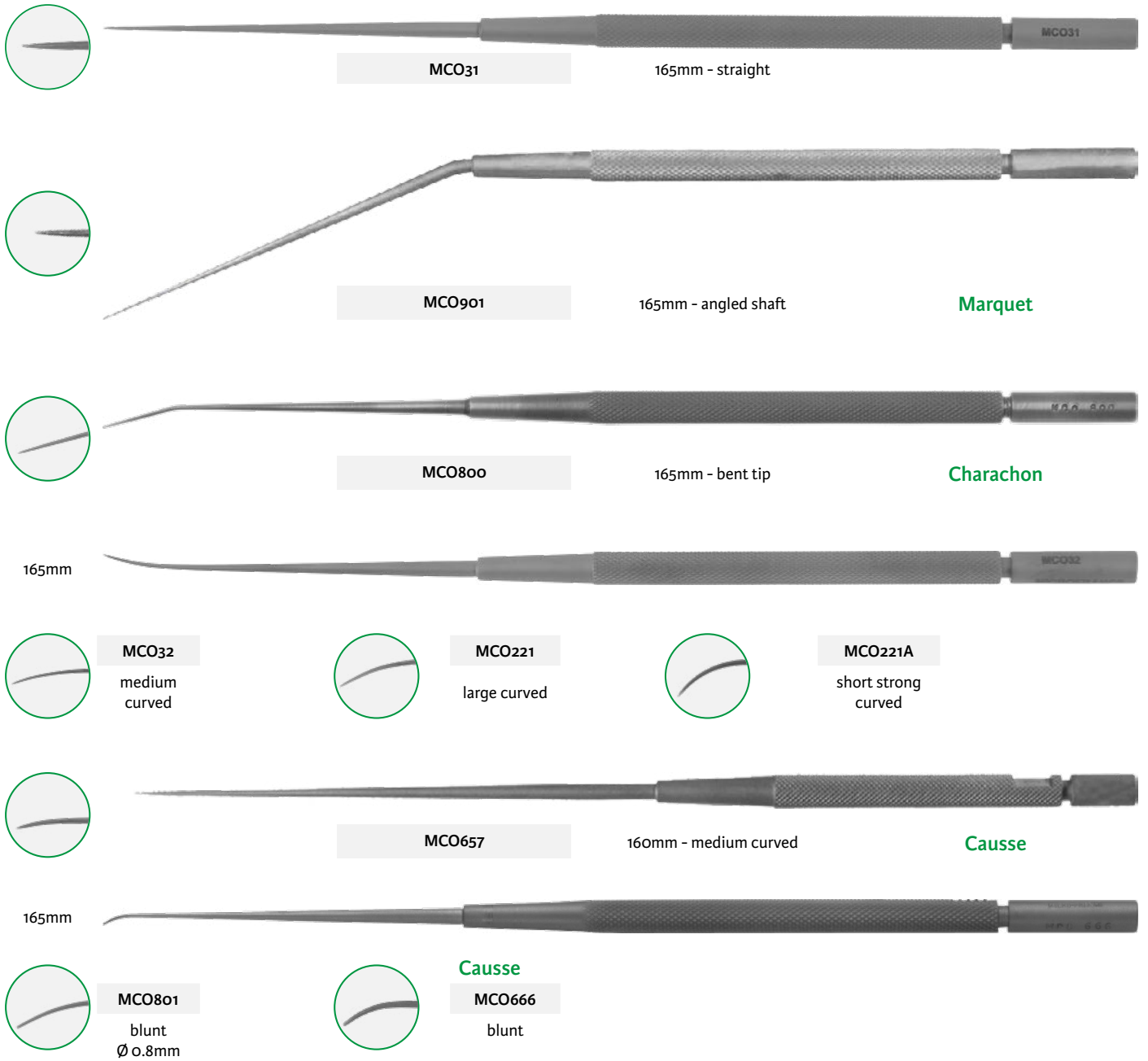



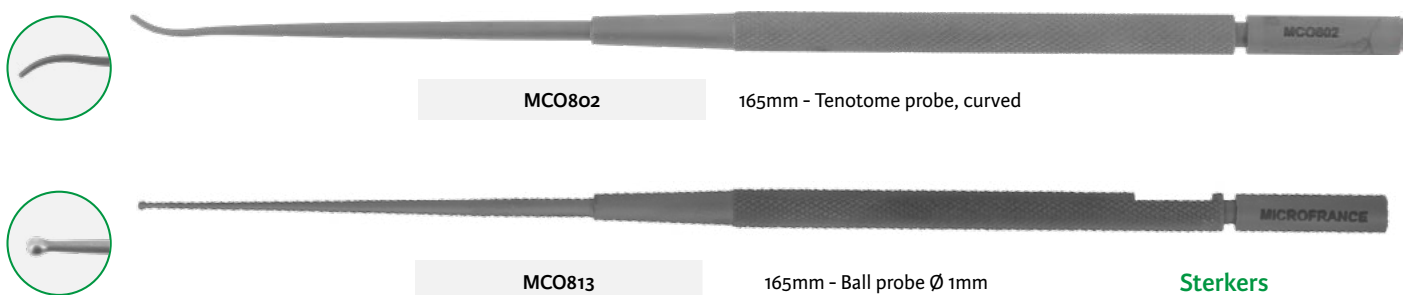









Tenotome probe - Ball probe



Micro hook, straight shaft

165mm
MCO6A









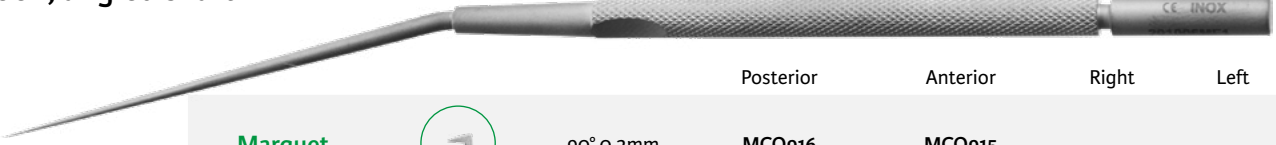

								
45°	MCO6A 0.7mm	Charachon 2mm	Legent 1mm		Marquet	Causse	Causse	Causse
								
90°	MCO205 0.3mm	MCO6B 0.7mm	MCO806A 2mm	MCO806B 4mm	MCO950 0.8mm	MCO654-1 1.2mm -right	MCO654-2 1.2mm - left	MCO841

Micro hook, angled shaft

165mm



				Posterior	Anterior	Right	Left
Marquet		90° 0.2mm	MCO916	MCO915			
Charachon		90° 0.2mm consolidated shaft	MCO832A	MCO832B	MCO832C	MCO832D	
Charachon		90° 0.3mm	MCO205A	MCO205B	MCO205C	MCO205D	
Causse		0.2mm	MCO663-2	MCO663-1			
Causse		0.4mm	MCO662-2	MCO662-1			
Causse		90° 0.4mm		MCO664			
Causse		90° 0.7mm		MCO665			
Marquet		45° 0.9mm		MCO920			

Micro hook, tip bent shaft

165mm



Poncet		90° 0.5mm	MCO226A Posterior	MCO226 Anterior	MCO226B Right	MCO226C Left
--------	---	--------------	----------------------	--------------------	------------------	-----------------

Micro joint knife



MCO209 angled shaft 165mm



MCO656 incudostapedial 45°

Cause

Micro raspatory



MCO9 90°

Micro hook - Micro raspatory



MCO9-1 Raspatory curved 90°

Thomassin



MCO804 Hook curved 90° 0.7mm tip bent shaft

Thomassin

Micro instrument, spoon handle

Portmann

Micro straight pick



MCO970

Micro hook 90°



MCO971T anterior 0.8mm



MCO973T anterior 0.3mm

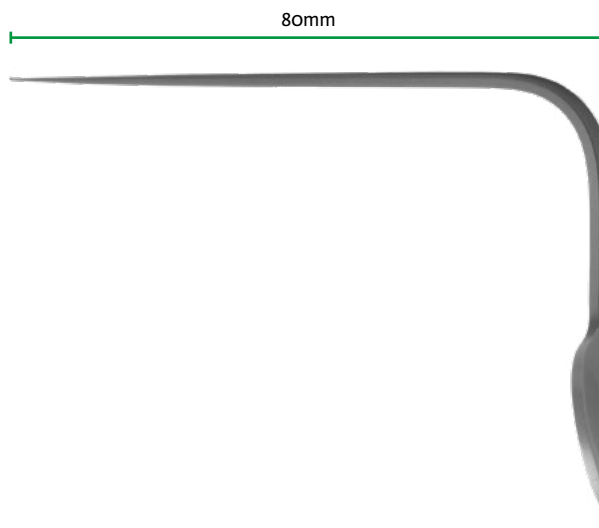

Monopolar curved elevator



MCO8BM

Bordure

140mm

Curved monopolar pick, blunt

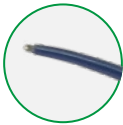

MCO989

Legent

180mm

Monopolar cables - 3.5 m

 CP391E Erbe ACC ICC/VIO Storz Wolf	 CP391M Aesculap Berchtold Lamidey Martin Erbe T Serie Sutter BM-780 II	 CP391V Bowa Bovie Conmed Valleylab
---	---	--

Bipolar forceps

Scale 1/4

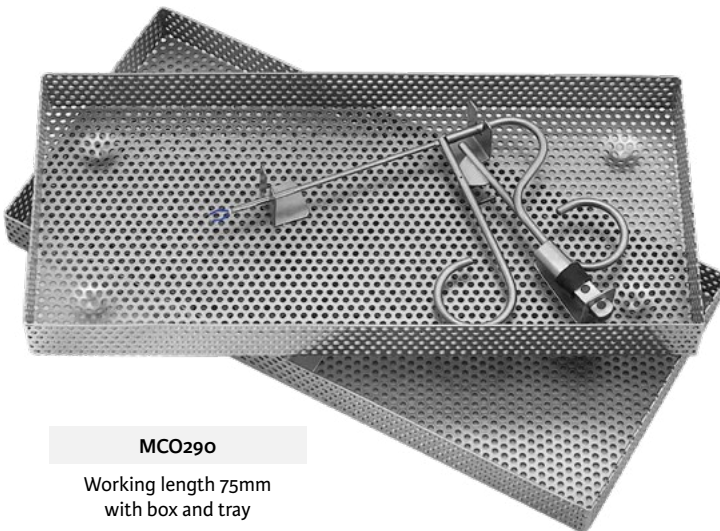

MCO290

Working length 75mm
with box and tray

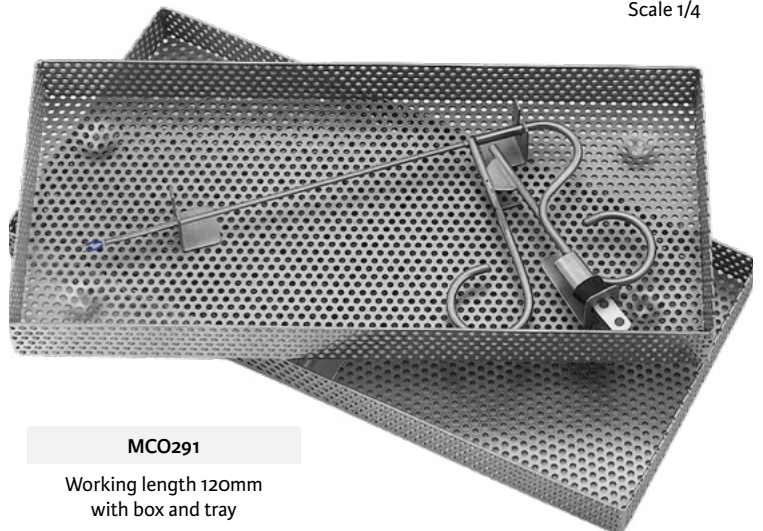

MCO291

Working length 120mm
with box and tray

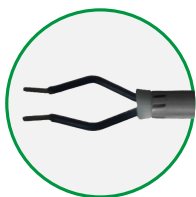

Bipolar cables - 4.5 m

 CP393-2 Bowa Emc Lamidey Valleylab	 CP393-3 Storz Wolf Erbe (except ICC VIO international)	 CP393-4 Aesculap Berchtold Martin Sutter BM-780 II
---	---	--

Micro measuring rod, angled shaft

165mm
MCO12B

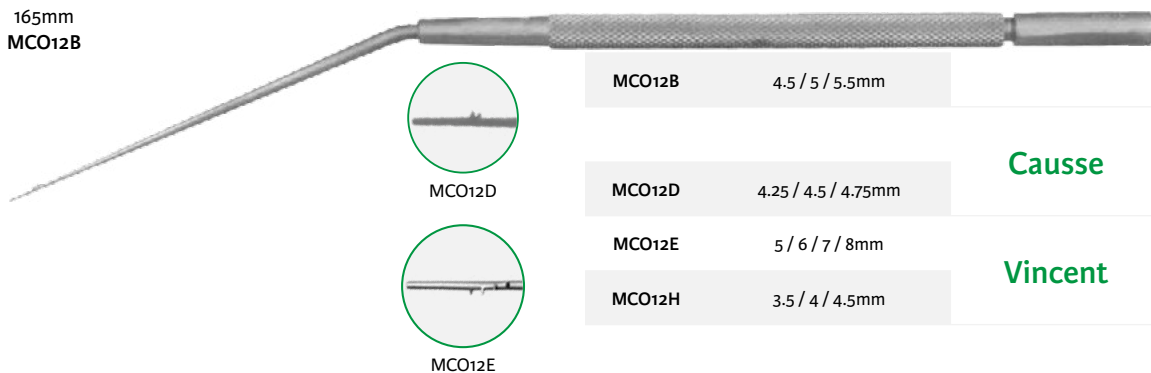

MCO12B 4.5 / 5 / 5.5mm

MCO12D 4.25 / 4.5 / 4.75mm

MCO12E 5 / 6 / 7 / 8mm

MCO12H 3.5 / 4 / 4.5mm

Cause

Vincent



MCO38 Micro measuring instrument

165mm

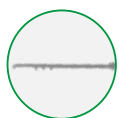

MCO12R malleable shaft 3 / 4 / 5mm

Robier

165mm



MCO830 straight shaft 3.5 / 4 / 4.5mm

Charachon

165mm

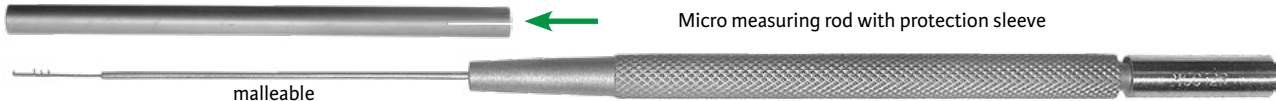

Micro measuring rod with protection sleeve

malleable

Ossiculoplasty sizer

MCOR45
165mm



MCOR20	MCOR25	MCOR30	MCOR35	MCOR40	MCOR45	MCOR50	MCOR55	MCOR60	MCOR65	MCOR70	MCOR75	MCOR80
2mm	2.5mm	3mm	3.5mm	4mm	4.5mm	5mm	5.5mm	6mm	6.5mm	7mm	7.5mm	8mm

Columella distance measuring rod forceps

Scale 2/3

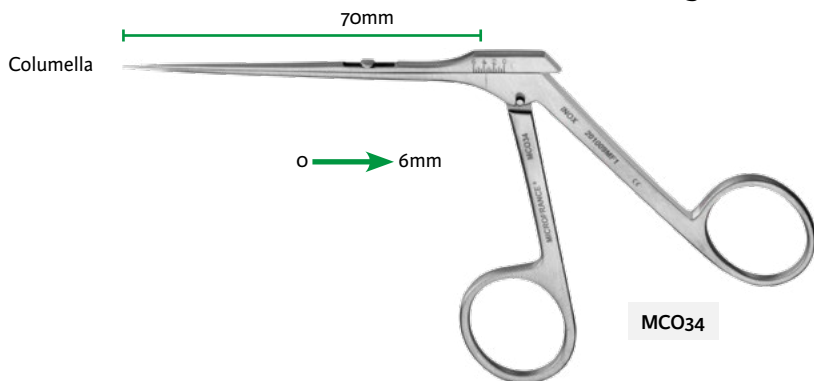
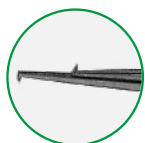

MCO34

Ossiculoplasty sizer



1 → 10mm



MCO844

Sauvage

165mm

Wire guide

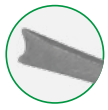

MCO997

Legent

165mm

Micro Punch for silastic



Vincent

MCO571

Ø 2,5 - 0,8mm
for silastic 1128305

Schucknecht device



MCO985 Device

Fascia press

Scale 1/3

Martin



MCO819



MCO820

Cartilage cutting block

Teixido

Martin



MCO255

0.3mm height of cut

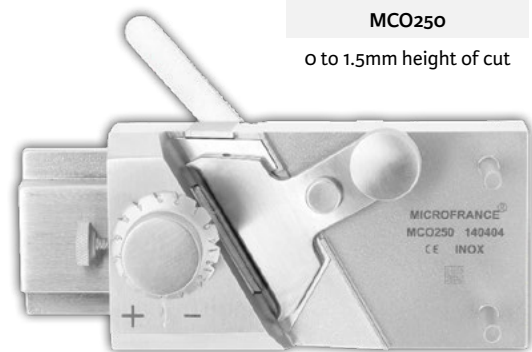

MCO250

0 to 1.5mm height of cut



Replacement blade

MCO251

Pack 10

Hand drill perforator

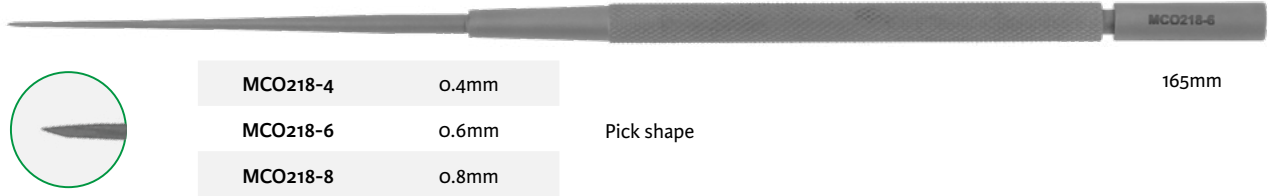

MCO218-4	0.4mm
MCO218-6	0.6mm
MCO218-8	0.8mm

Pick shape

165mm

Piston trimming gauge



MCO213-4	∅ 0.4 / 0.6mm
MCO213-6	∅ 0.6 / 0.8mm

Preparation glass plate - Teflon cutting block



Cause

Preparation glass plate	
65x65x4mm	
with hole	
MCO660-10	hole 1.0mm
MCO660-12	hole 1.2mm
MCO660-8	hole 0.8mm
without hole	
MCO660-2	65x65x2mm

Otoplasty

Scale 1/1

Stenstrom



Rasp
160mm
2x8mm

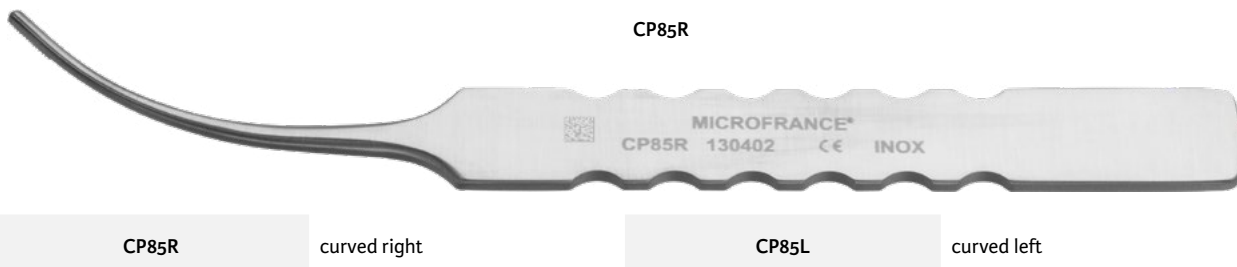

CP85R

curved right

CP85L

curved left

Stenstrom

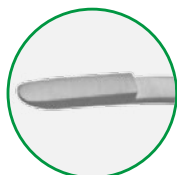

Elevators
160mm
2x8mm



CP85AR

curved right

CP85AL

curved left

Suction foot switch

Scale 1/5



Darrouzet

MCO551

Delivered with
Trumpet valve device
and security valve

Accessories for suction foot switch

Scale 1/2

security valve device - Pk 6































trumpet valve device



Composition of Cause set

Reference	Description
7874MF-34	Stainless steel sterilization case 380x205x85mm 340x200x80mm
MCO670-1	Cause sterilization tray metal 335x195mm for container 7874MF-34
MCO12D	Cause measuring rod 4.25/4.5/4.75mm measurements angled shaft 165mm length
MCO12E	Vincent measuring rod 5/6/7/8mm measurements angled shaft 165mm length
MCO12H	Vincent measuring rod 3.5/4/4.5mm measurements angled shaft 165mm length
MCO13C	Hartmann forceps 0.6x3mm serrated jaws WL 65mm
MCO213-4	Piston trimming gauge with 0.4/0.6mm holes from 3 to 6mm 120mm length
MCO27	Dieter malleus nipper forceps 2.3mm jaws WL 65mm
MCO4A	Straight micro scissors blades 3mm tips WL 65mm
MCO571	Vincent punch 2.5x0.8mm diam. for Silastic 1128305
MCO650	Cause knife 90deg 3mm diam. tip bent shaft (A) 165mm length
MCO651	Cause lancet knife 1.5x2mm 45deg bent shaft (B) 165mm length
MCO652	Cause knife 45deg 3mm diam. tip (C) 165mm length
MCO653	Cause lancet knife 1.5x2mm 45deg (D) 165mm length
MCO654-1	Cause tendon hook cutting right 90deg 1.2mm (E1) 165mm length
MCO654-2	Cause tendon hook cutting left 90deg 1.2mm (E2) 165mm length
MCO655	Cause angled curette 2.8mm diam. tip (G) 160mm length
MCO656	Cause incudostapedial joint knife 45deg (H) 165mm length
MCO657	Cause curved pick (I) 160mm length
MCO658	Cause piston crimping forceps WL 65mm
MCO660-10	Cause preparation glass plate 65x65x4mm with hole 1mm diam.
MCO660-12	Cause preparation glass plate 65x65x4mm with hole 1.2mm diam.
MCO660-2	Cause preparation glass plate 65x65x2mm
MCO660-8	Cause preparation glass plate 65x65x4mm with hole 0.8mm diam.
MCO661-10	Cause malleable suction tube with luer-lock connection 1mm diam. WL 90mm
MCO661-7	Cause malleable suction tube with luer-lock connection 0.7mm diam. WL 90mm
MCO662-1	Cause anterior curved hook 0.4mm tip angled shaft (O1) 165mm length
MCO662-2	Cause posterior curved hook 0.4mm tip angled shaft (O2) 165mm length
MCO663-1	Cause anterior curved hook 0.2mm tip angled shaft (P1) 165mm length
MCO663-2	Cause posterior curved hook 0.2mm tip angled shaft (P2) 165mm length
MCO664	Cause anterior hook 90deg 0.4mm tip angled shaft (Q) 165mm length
MCO665	Cause anterior hook 90deg 0.7mm tip angled shaft (R) 165mm length
MCO666	Cause curved pick blunt (S) 165mm length
MCO667	Cause flap elevator 2x3mm 45deg 165mm length
MCO820	Martin fascia press
MCO841	Cause hook 90deg (F) 165mm length

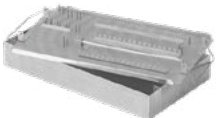
Composition of the complete set on request

			
MCO13C	MCO213-4	MCO27	
			
MCO4A	MCO571	MCO820	
			
MCO650	MCO651	MCO652	
			
MCO653	MCO654-1	MCO654-2	
			
MCO655	MCO656	MCO657	
			
MCO662-1	MCO663-1	MCO665	
			
MCO657	MCO658	MCO841	
			
MCO12H	MCO12E	MCO661-10	
			
MCO660-12	MCO660-2		
			
MCO670-1	7874MF-34		

Picture for information, without scale

MCO901



Instruments 165 mm angled shaft

Straight pick	Chisel	Anterior hook 90° 0.2mm	Posterior hook 90° 0.2mm	Anterior hook 45° 0.9mm	Raspatory upward	Raspatory backward
MCO901	MCO910M	MCO915	MCO916	MCO920	MCO917	MCO918



Instruments 165 mm straight shaft

Knife 45° 2.8X3.5mm	Blunt hook 90° 0.8mm	Elevator 60° 1.3x2mm	Angled elevator right	Angled elevator left	Ball probe 1mm
MCO932	MCO950	MCO904	MCO905	MCO906	MCO924



Double elevators

	MCO925 180mm 3mm			MCO929 170mm double angled	
	MCO926 180mm flat 1.7 / 5mm			MCO951 170mm curved	
	MCO928 175mm curved 0.9mm				

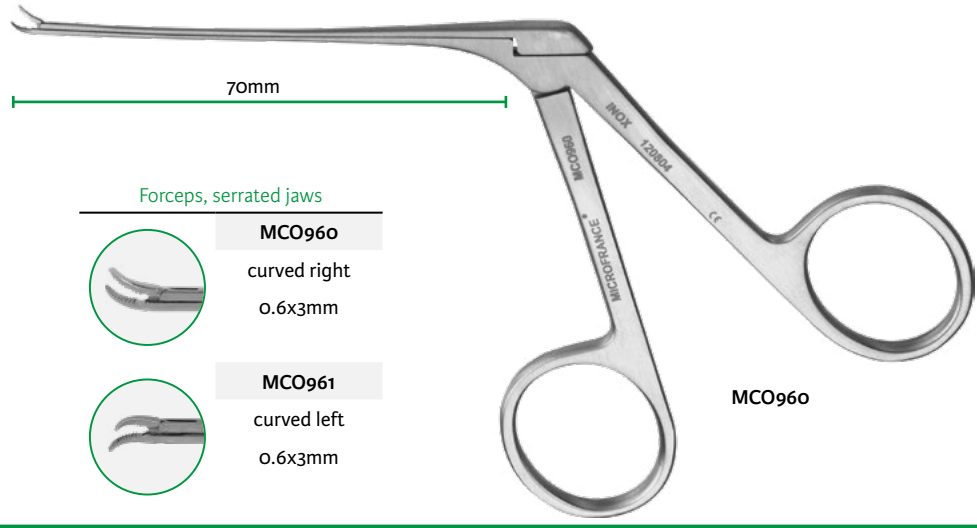

Forceps, serrated jaws

	MCO960 curved right 0.6x3mm
	MCO961 curved left 0.6x3mm

MCO960



Whirlybird elevator, angled, 165mm



3722001 0,75mm left

3722002 0,75mm right

Guilford-Wright instruments



Micro hook 0,5mm 165mm



3722020 45°

3722021 90°

Shea instrument



Micro hook 90° 165mm



3722142 1mm



Micro knife 165mm

A	3722031	45°	Ø 2mm
----------	----------------	-----	-------

Hook 90° 165mm

B	3722035	0,6mm	
----------	----------------	-------	--

Stapedectomy hook 165mm

C	3724287	45°	0,33mm
----------	----------------	-----	--------

Excavator, angled shaft, 160mm

D	3724291	90°	0,5mm
----------	----------------	-----	-------

Jordan instrument



Stapedectomy lancet knife 165mm



3724293

45°

2x3mm

3724293

Micro raspatory - Micro hook

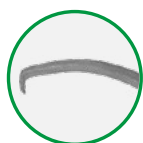

MCO9-1

Raspatory 90°

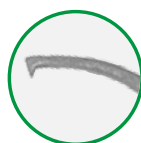

MCO804

Hook 90° 0,7mm

Micro double angled elevator



MCO929

double angled

Marquet

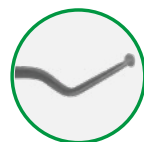

MCO240

double angled

whirlybird

Chobaut

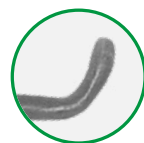

Suction tube adapter - Micro angled suction tube

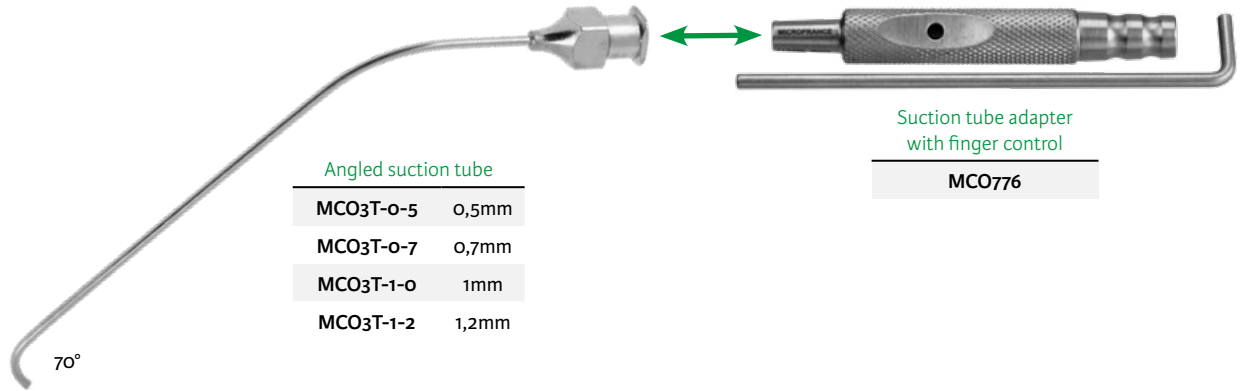

Micro forceps

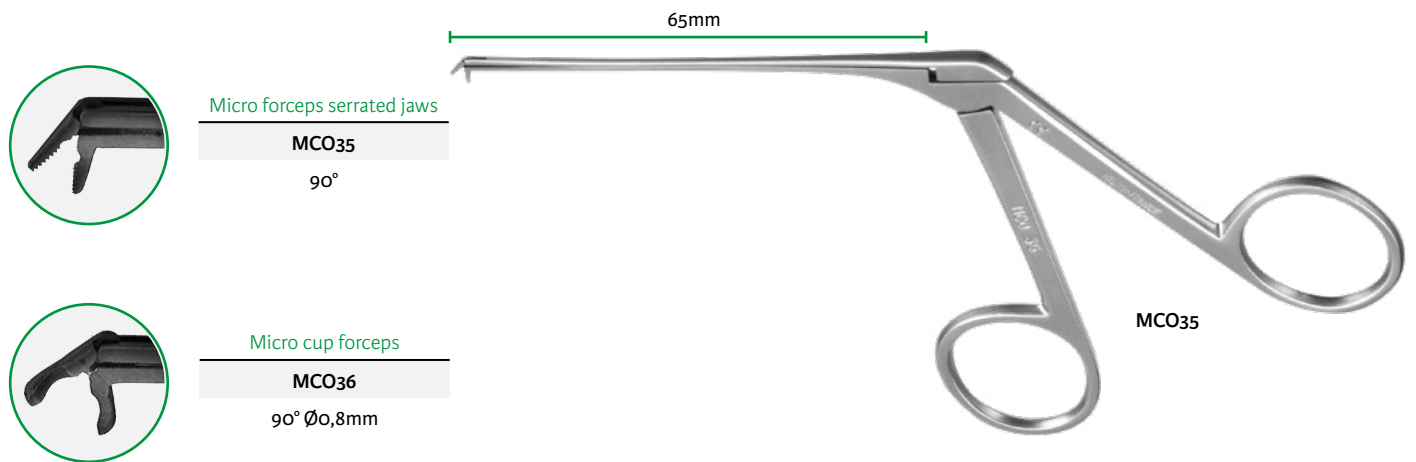

Container - Tray

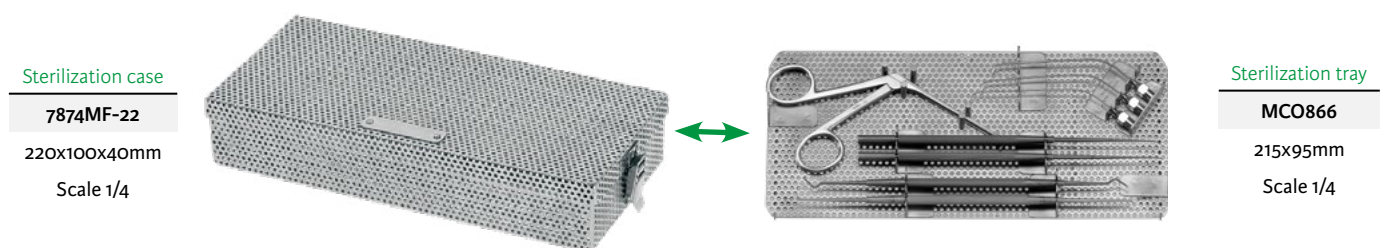

Micro lancet knife

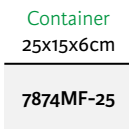
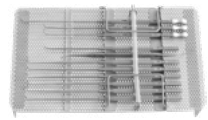
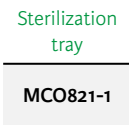
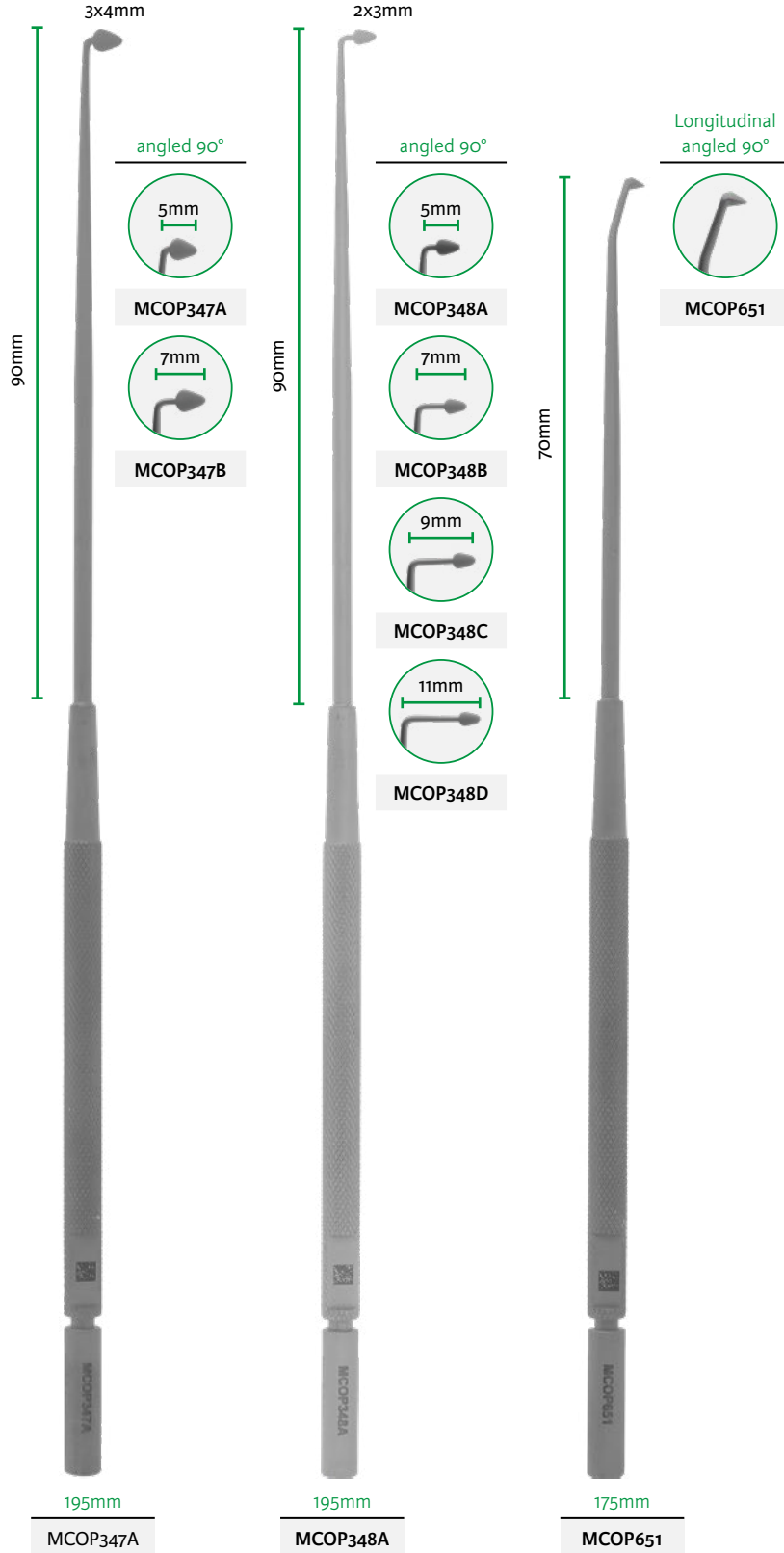

Micro curette Suction tube elevator

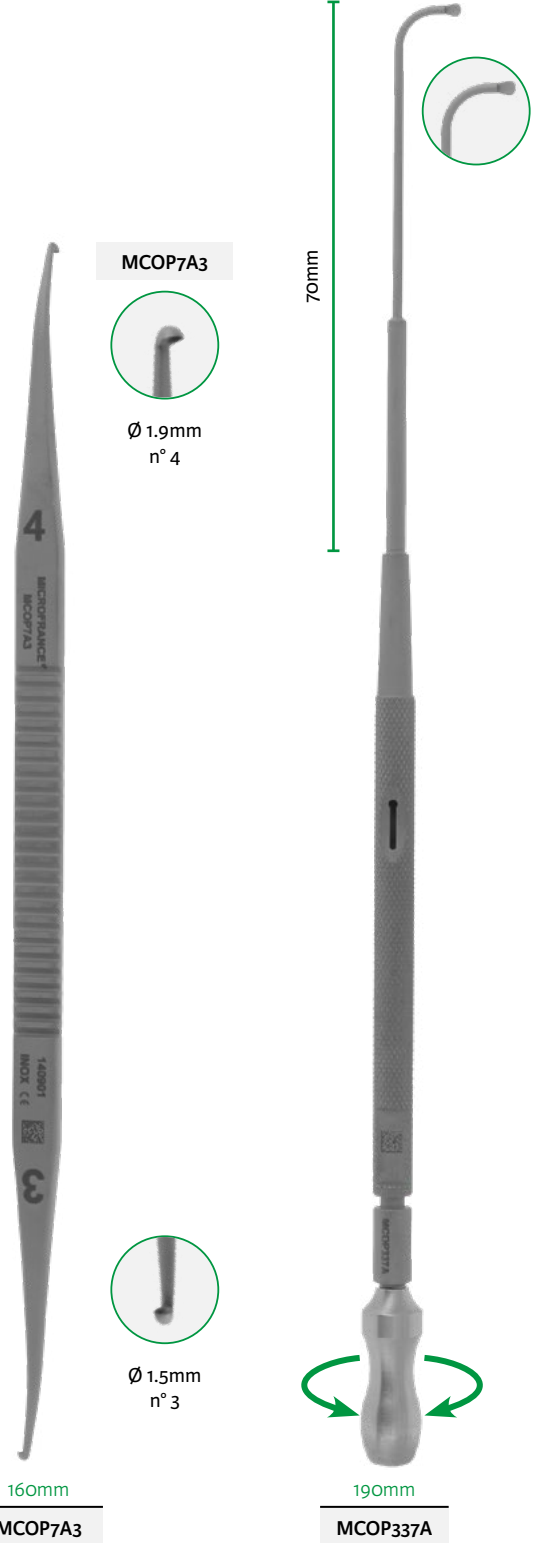

Suction tube with finger control

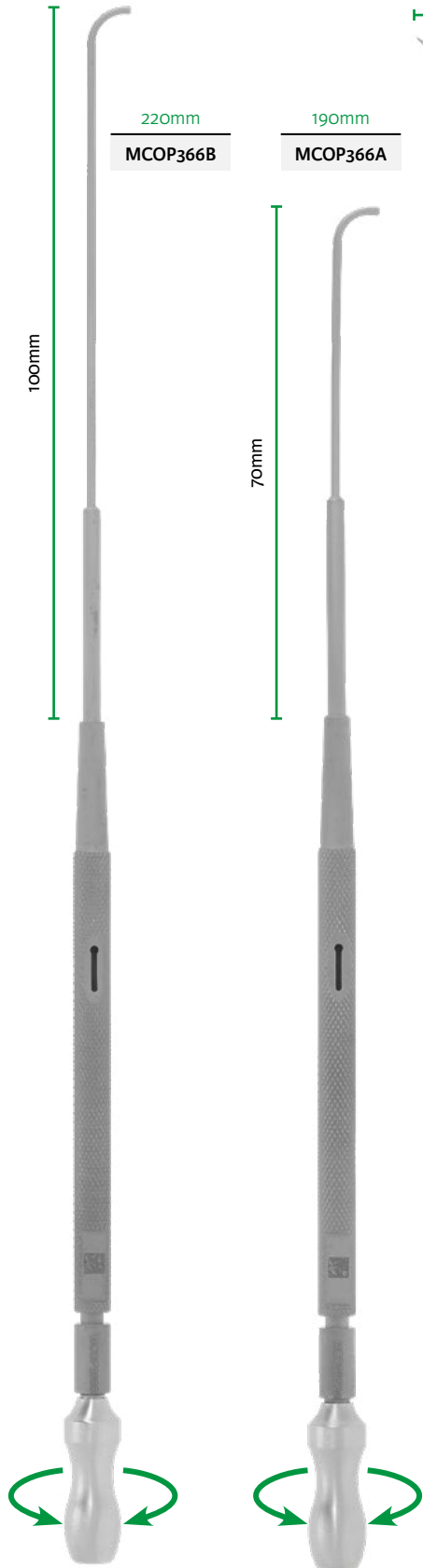

Alligator forceps

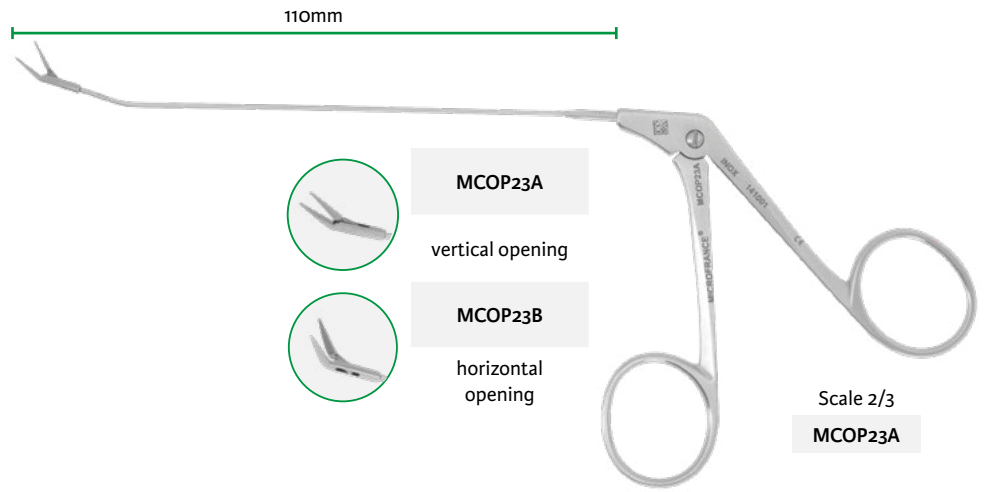

Wire crimper forceps

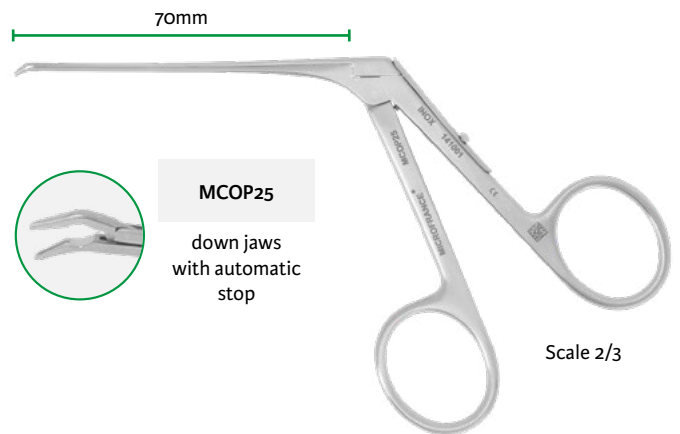

Fascia press

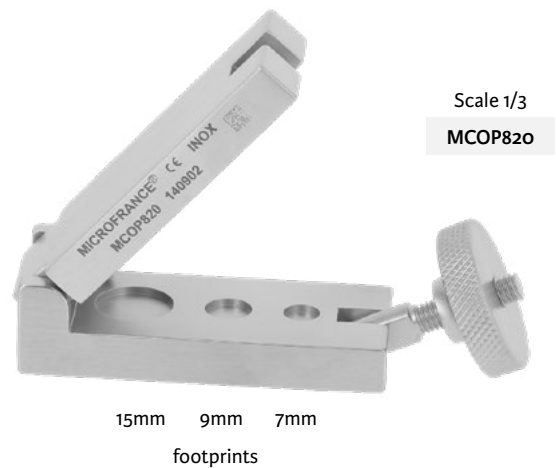

Scale 2/3

«L» Working length



Fraysse

Micro blunt eyes suction tube

115mm

L 115mm		L 150mm	
MCO367F10	1mm	MCO368F20	2mm
MCO367F12	1.2mm	MCO368F25	2.5mm
MCO367F15	1.5mm		
MCO367F20	2mm		

MCO367F10

100mm

MCO354

MCO354 1.2mm



Zimmermann



Micro suction tube with finger control

140mm

blunt eyes suction tube

L 110mm		L 140mm	
Charachon			
MCO352E20	2mm	MCO352N20	2mm
MCO352E25	2.5mm	MCO352N25	2.5mm

MCO352N25



120mm

blunt eyes suction tube

MCO770L15	1.5mm	MCO770L30	3mm
MCO770L20	2mm	MCO770L35	3.5mm
MCO770L25	2.5mm	MCO770L40	4mm

MCO770L30

Micro suction irrigation tube with finger control



Brackman

90mm

MCO352-20	2mm
MCO352-25	2.5mm
MCO352-30	3mm

blunt eyes suction tube

MCO352-25

Micro scissors, micro forceps

Sterkers

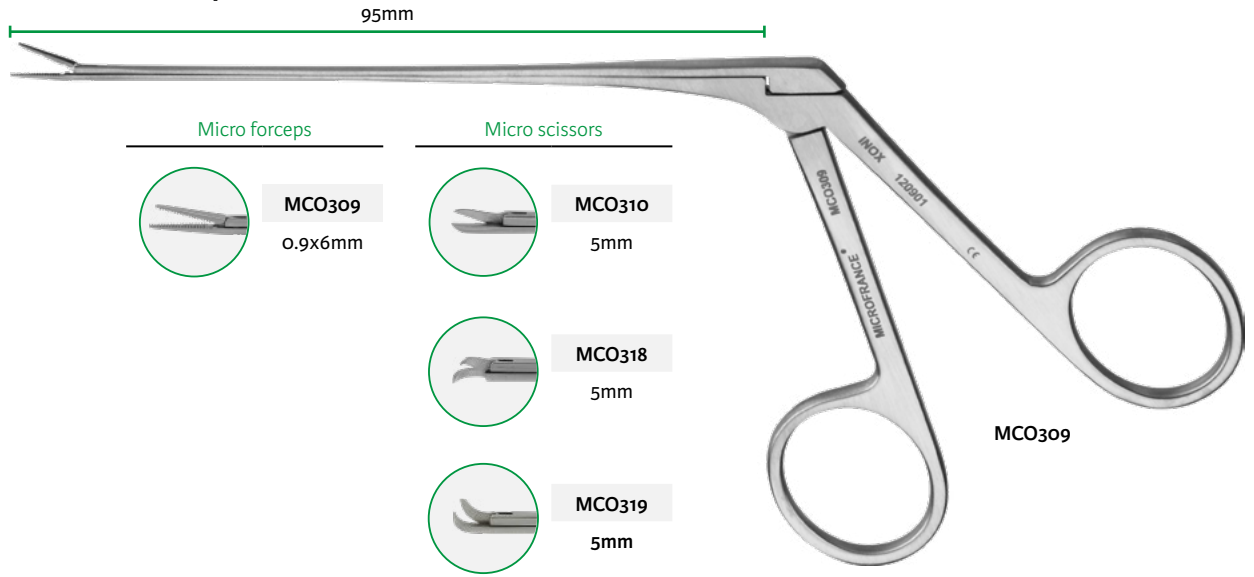

Self-retaining retractor

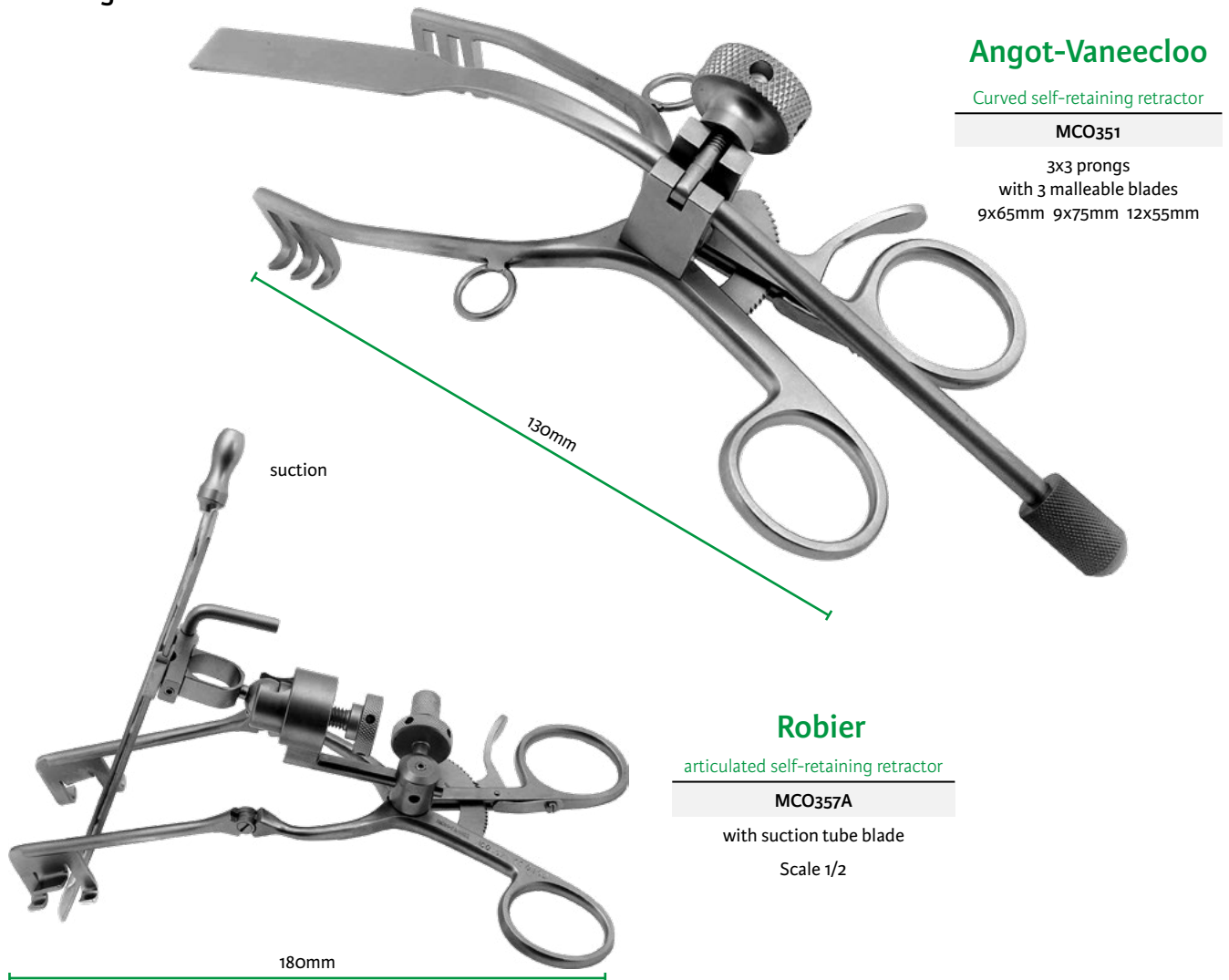

Scale 2/3

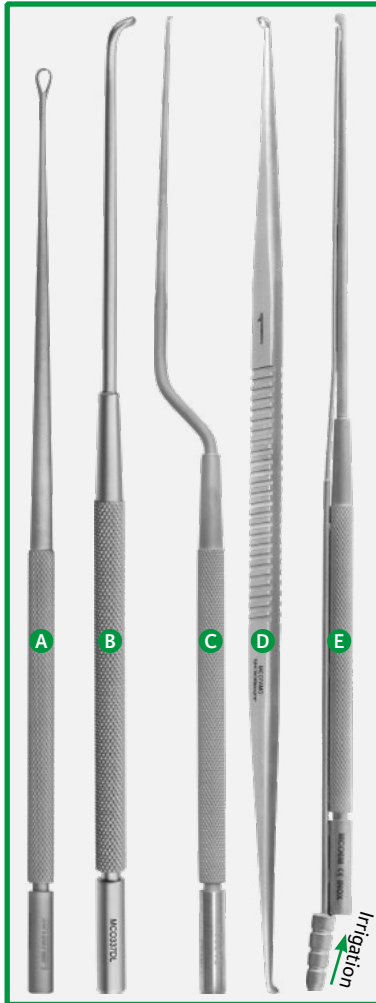

Micro instruments

Sterkers

Sickle knife 180mm		MCO301	7mm
		MCO302	90° 2mm
Hook 180mm		MCO303	90° 1.2mm
		MCO304	90° 0.8mm
Fenestrated curette 180mm		MCO320 A	3mm
		MCO321	4mm
		MCO322	6mm

Instruments, tip bayonet shaft

Hook 190mm		MCO341	2mm left
Magnan		MCO340 C	2mm right
Blunt pick 190mm		MCO342	straight
Bruzzo		MCO343	curved

Elevator and raspatory

Whirlybied elevator 180mm		MCO337DL B	left
Dubreuil		MCO337DR	right
Raspatory 175mm		MCO224G	45° 7x4mm
Gentine			
Elevator 195mm		MCO333	curved 1.5x7mm
Klap			

Mom micro instruments

Mom

Angled curette double 190mm		MCO7AMO D	2.2 / 2.5mm n° 1/2
Oval knife 190mm		MCO6M E	2x2.5mm with irrigation
Sickle knife 190mm		MCO10MO	5mm with irrigation
Curved pick 190mm		MCO221MO	with irrigation
Ball seeker 190mm		MCO330MO	2mm 90° with irrigation







Micro instruments



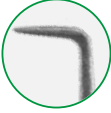

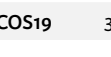

Selesnick

Scale 2/3

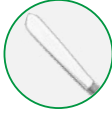

190mm

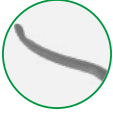
Hook			Knife 45°			Curette	
							
MCOS14	MCOS15	MCOS16	MCOS17	1mm	MCOS18	MCOS25	MCOS26
45° 3mm	90° 2mm	90° 2.8mm		2mm		Ø 1mm straight	Ø 1mm angled
				3mm			

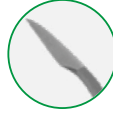
Elevator					Sickle knife	
						
MCOS20	MCOS21	MCOS22	MCOS23	MCOS30	MCOS31	MCOS32
14 x 1.5mm	3mm	5 x 1mm	7 x 2mm	left	right	5mm

Cup forceps, micro scissors



125mm

Scale 2/3

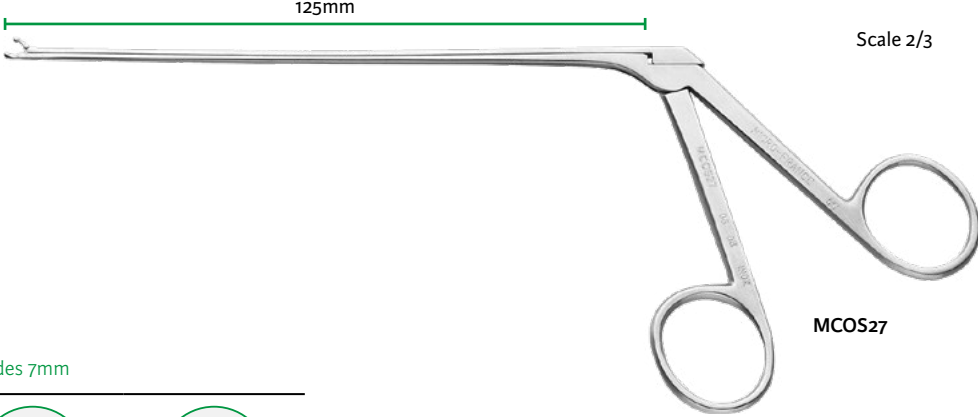



Cup forceps



MCOS27

	
MCOS27	MCOS29
1mm	3mm

Micro scissors, blades 7mm

			
MCOS33	MCOS34	MCOS35	MCOS36
straight	angled up	left curved	right curved

Curved self-retaining retractor

Angot-Vaneecloo

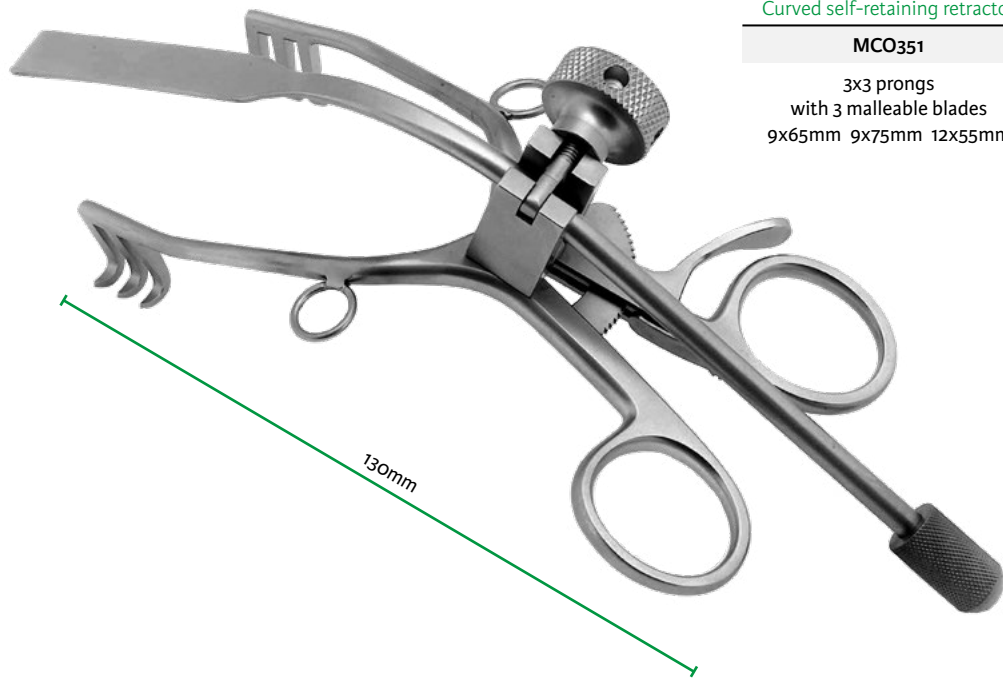

Curved self-retaining retractor

MCO351

3x3 prongs
with 3 malleable blades
9x65mm 9x75mm 12x55mm

Bipolar forceps

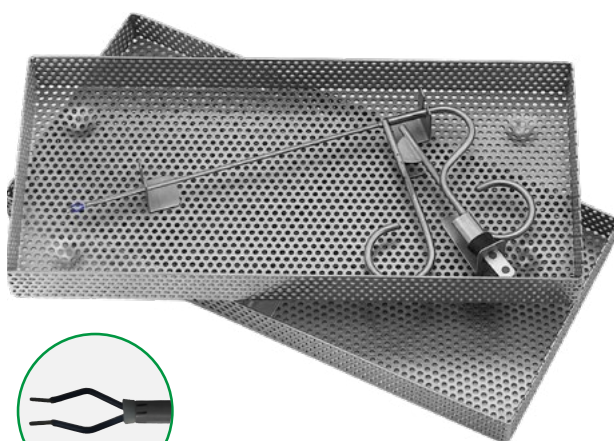

Bipolar forceps

MCO291

Working length 120mm
with box and tray
Scale 1/3

Page 36

Sterilization case

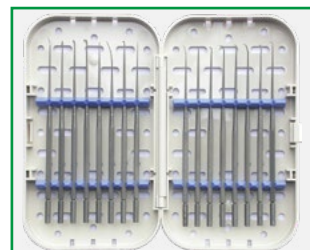

Plastic sterilization case

3717022

210x123x36mm
for 16 instruments
Scale 1/5

Stainless steel cup



7876-60^{(D)*}

Cup

7876-60 ^{(D)*}	60mm
7876-80 ^{(D)*}	80mm
7876-100 ^{(D)*}	100mm
7876-120 ^{(D)*}	120mm
7876-160 ^{(D)*}	160mm

Stainless steel sterilization tray



7872-24^{(D)*}
Scale 1/2

Tray

7872-24 ^{(D)*}	240x180mm
-------------------------	-----------

^(D) Distributed by Integra MicroFrance SAS (France) - For corresponding manufacturer part numbers, see table in annex.

* Please check with your sales representative availability of this product in your country.

Scale 1/5

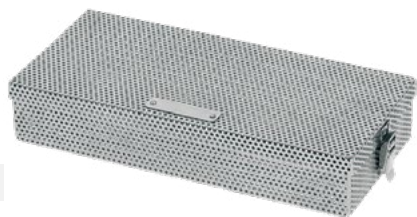

7874MF-22

240x105x45mm
220x100x40mm

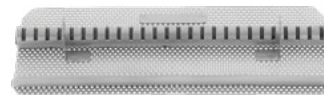

MCO865-1

for 26 burs

Scale 1/5

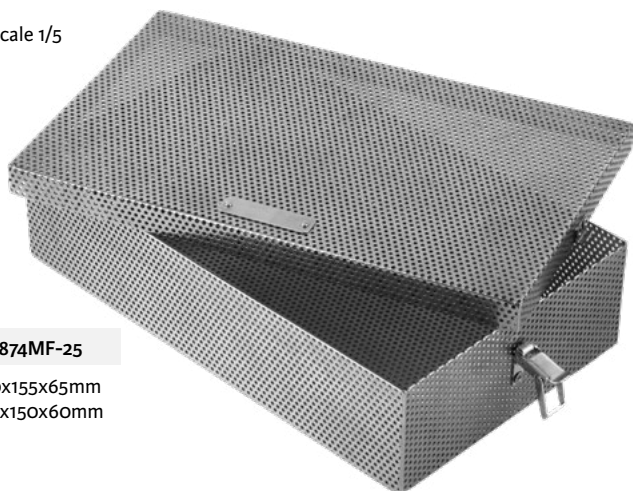

7874MF-25

270x155x65mm
250x150x60mm

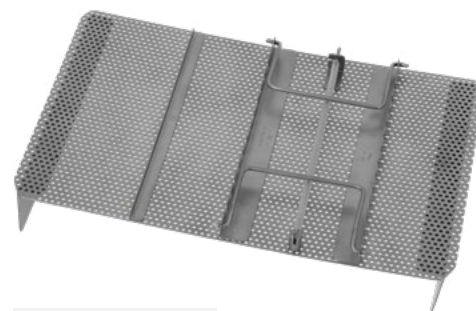

MCO821-1

12 micro instruments

Scale 1/5

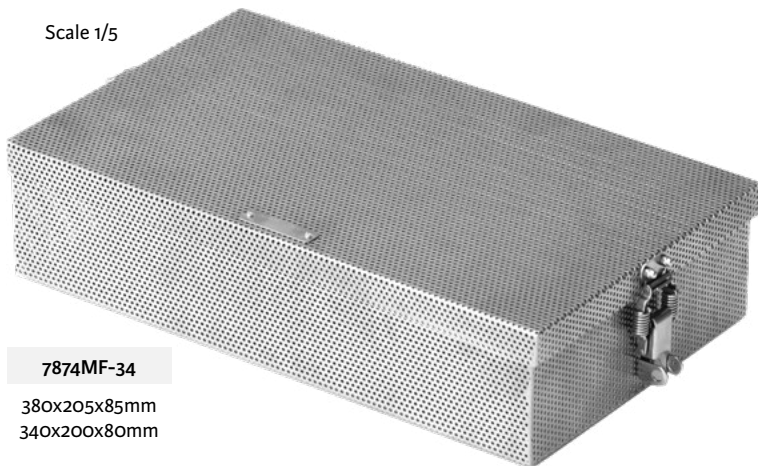

7874MF-34

380x205x85mm
340x200x80mm

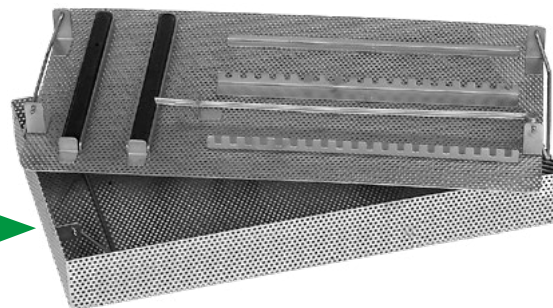

MCO824-1

Set micro instruments

Scale 1/5

7874MF-40

440x205x95mm - 400x200x90mm

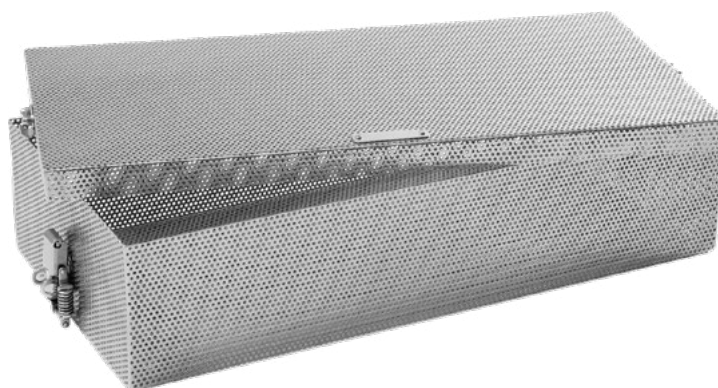

Scale 1/4

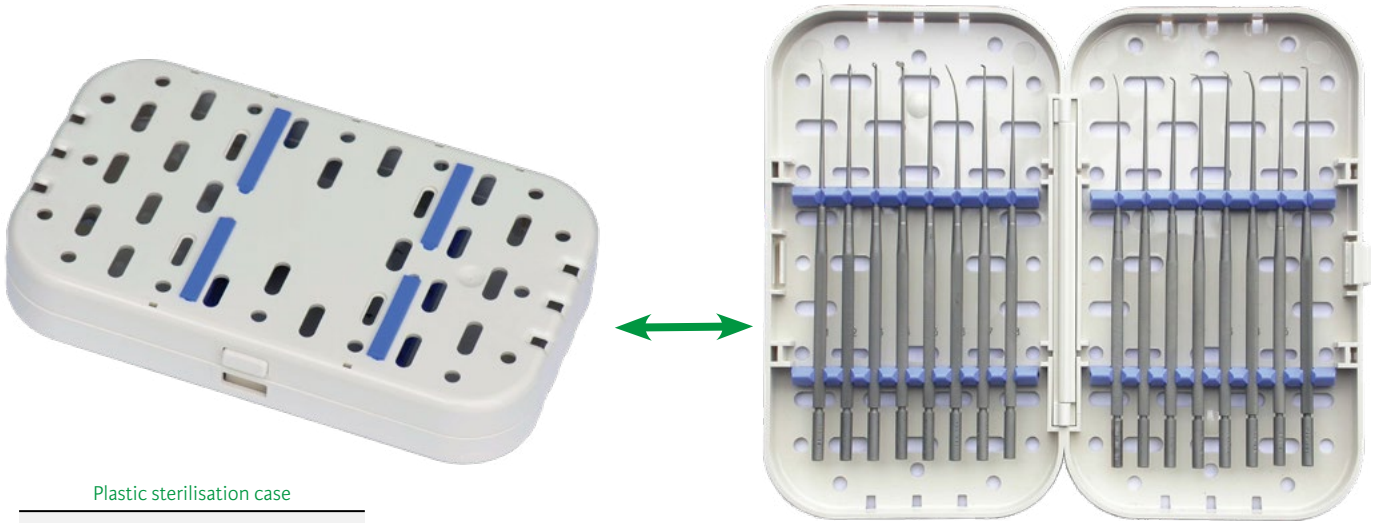

Plastic sterilisation case

3717022

210x123x36mm

for 16 micro instruments



Aluminum sterilization tray

3717025

248x221x45mm

for 32 micro instruments



Numerical index

O

O-28	17
O-28-1	17
O-28-2	17
O-28-3	18
O-28-4	18
O-28-7	19
O-28-8	17

1

1003IG(D)	7
1003LI(D)	7
1004IG(D)	7
1005I(D)	7

3

3714027	16
3714028	16
3717022	75, 78
3717025	78
3722001	63
3722002	63
3722020	64
3722021	64
3722031	65
3722035	65
3722142	64
3722150	5
3722151	5
3724059	14
3724287	65
3724291	65
3724293	66

7

702T	35
703T	35
704T	35
714T	35
7718	3
7719-2	2
7721-1	5
7725	5
7725P1	5
7725P2	5
7725P3	5
7726MF	11
7727	11
7728	11
7731	2
7732-1	11
7733	11
7734	11
7764	24
7766	21
7768	15

7768-1	15
7779MF-1	12
7779MF-2	12
7779MF-3	12
7779MF-5CC	12
7781	20
7782-1-2	16
7787-10	14
7831A-12	30
7831A-15	32
7833A-12	30
7833A-15	32
7866-13	39
7867-1	36
7867-2	36
7867-3	36
7867-4	36
7872-24(D)	76
7874MF-22	68, 77
7874MF-25	69, 77
7874MF-34	60, 61, 77
7874MF-40	77
7875(D)	4
7876-60(D)	76
7876-80(D)	76
7876-100(D)	76
7876-120(D)	76
7876-160(D)	76
7885	3
7885A	3
7886	3
7888	3
7897	9
7898	9
7899	9

8

8812-1	8
8812-2	8
8812-3	8
8812-4	8
8812-5	8
8814T1	8
8814T2	8
8814T3	8
8814T4	8
8814T5	8

9

9912-7(D)	8
9912-8(D)	8
9912-9(D)	8
9913-1(D)	8
9913-2(D)	8
9913-3(D)	8
9913-4(D)	8
9913-5(D)	8
9913-6(D)	8

C

CEV984	10
CEV985	10
CP16	26
CP16-1	26
CP17	15
CP17-1	15
CP17-2	15
CP17-3	15
CP21-3	16
CP21A-3	16
CP37	30
CP85AL	59
CP85AR	59
CP85L	59
CP85R	59
CP300	22
CP302-2	50
CP302-3	50
CP302-4	50
CP302-5	50
CP302-6	50
CP302-8	50
CP330-3-0	40
CP330-4-0	40
CP332	30
CP335	16
CP351-2	28
CP351-3	28
CP351-6	28
CP351-7	28
CP352	29
CP352-1	29
CP352-2	29
CP352-3	29
CP353	26
CP354	26
CP354A	26
CP356	26
CP358	26
CP358A	26
CP363	27
CP380	25
CP380-1	25
CP380-2	25
CP380-3	25
CP380-5	25
CP390-1	34
CP390-2	34
CP390-8	34
CP391E	34, 54
CP391M	34, 54
CP391V	34, 54
CP392-1R	33
CP392-2R	33
CP392-8R	33
CP392BI	33
CP392BS	33
CP393-2	33, 54
CP393-3	33, 54

CP393-4	33, 54
CP400	32
CP400-1	30
CP406	30
CP407	32
CP414	30
CP415	32
CP604	31
CP604-15	31
CP604BR	33
CP604M	34
CP605	31
CP605-15	31
CP605BR	33
CP605M	34
CP606	31
CP606-15	31
CP606A	31
CP609	16
CP611	13
CP625	13
CP626	13
CP627	13
CP628	15
CP637	27
CP801-7	23
CP801-10	23
CP821	7
CP821B	6
CP821C	6
CP821D	6
CP821E	6
CP822-10	15
CP822-12	15
CP822-14	15
CP823-5	23
CP824-5	23
CP825	14
CP907	22
CP919	26
CP919A	26
CP922	27
CP922A	27
CP922B	27
CP931	28
CP931-1	28
CP933-14	32
CP934	32
CP934-1	32
CP938-1	30
CP941	15
CP985	13
CP988-15	32
CP1107	35

M

M832	31
M833	31
MCEN23-2-5	41

^(D) Distributed by Integra MicroFrance SAS (France) - For corresponding manufacturer part numbers, see table in annex

MCEN23-3-0.....	41	MCO13C	44, 60, 61	MCO226	52	MCO367F12.....	71
MCEN770J30.....	40	MCO13D	44	MCO226A.....	52	MCO367F15.....	71
MCEN770J40.....	40	MCO13E.....	44	MCO226B.....	52	MCO367F20.....	71
MCL359	20	MCO17	44	MCO226C	52	MCO368F20.....	71
MCO1B.....	41	MCO21	45	MCO233	9	MCO368F25.....	71
MCO2	48	MCO21A	45	MCO237.....	9	MCO551.....	59
MCO3Po5.....	43	MCO21B	45	MCO240.....	49, 67	MCO551A	59
MCO3Po7.....	43	MCO21C	45	MCO250.....	57	MCO551B	59
MCO3P10	43	MCO21D.....	45	MCO251.....	57	MCO571.....	56, 60, 61
MCO3P12.....	43	MCO21G.....	45	MCO255	57	MCO650.....	48, 60, 61
MCO3P15.....	43	MCO21H.....	45	MCO270.....	46	MCO651.....	48, 60, 61
MCO3P18.....	43	MCO21I.....	45	MCO271.....	46	MCO651F.....	48
MCO3P20.....	43	MCO22	44	MCO272	46	MCO652.....	48, 60, 61
MCO3P24	43	MCO23	44	MCO290.....	54	MCO653	48, 60, 61
MCO3T-0-5.....	68	MCO23A.....	44	MCO291.....	54, 75	MCO654-1.....	52, 60, 61
MCO3T-0-7.....	68	MCO23B	44	MCO301.....	73	MCO654-2	52, 60, 61
MCO3T-1-0	68	MCO25	47	MCO302.....	73	MCO655	50, 60, 61
MCO3T-1-2.....	68	MCO25H.....	47	MCO303	73	MCO656.....	53, 60, 61
MCO4	45	MCO26	47	MCO304.....	73	MCO657	51, 60, 61
MCO4A.....	45, 60, 61	MCO27	46, 60, 61	MCO305.....	13	MCO658.....	47, 60, 61
MCO4B.....	45	MCO31.....	51	MCO309.....	72	MCO660-2.....	58, 60, 61
MCO4C.....	45	MCO32	51	MCO310.....	72	MCO660-8.....	58, 60
MCO4D	45	MCO34	55	MCO311-1-0	41	MCO660-10.....	58, 60
MCO4E	45	MCO35	68	MCO311-1-2.....	41	MCO660-12.....	58, 60, 61
MCO5	48	MCO36	68	MCO311-1-5.....	41	MCO661-7.....	43, 60
MCO5A-1-0.....	48	MCO37.....	49	MCO311-1-8.....	41	MCO661-10.....	43, 60, 61
MCO5A-1-5	48	MCO37-1.....	49	MCO311-2-0.....	41	MCO662-1.....	52, 60, 61
MCO5A-2-0	48	MCO37D.....	49	MCO311-2-5.....	41	MCO662-2	52, 60
MCO5A-2-5.....	48	MCO37G.....	49	MCO311-3-0.....	41	MCO663-1.....	52, 60, 61
MCO5B.....	48	MCO38	55	MCO311-3-5.....	41	MCO663-2	52, 60
MCO5C.....	48	MCO201-2-5.....	40	MCO311-4-0.....	41	MCO664.....	52, 60
MCO5D.....	48	MCO201-3-0.....	40	MCO312.....	48	MCO665.....	52, 60, 61
MCO5E	48	MCO204C.....	48	MCO313.....	48	MCO666.....	51, 60
MCO6	48	MCO205.....	52	MCO318.....	72	MCO667	49, 60
MCO6A.....	52	MCO205A	52	MCO319.....	72	MCO670-1.....	60, 61
MCO6B.....	52	MCO205B.....	52	MCO320.....	73	MCO770-1-5	40
MCO6C.....	48	MCO205C.....	52	MCO321.....	73	MCO770-2-0	40
MCO6M.....	73	MCO205D.....	52	MCO322	73	MCO770-2-5.....	40
MCO7-1	50	MCO207-1-5	50	MCO330MO.....	73	MCO770-3-0	40
MCO7-3	50	MCO207-2-0	50	MCO333.....	73	MCO770-3-5	40
MCO7A-1.....	50	MCO209.....	53	MCO337DL.....	73	MCO770-4-0	40
MCO7A-3	50	MCO210.....	49	MCO337DR.....	73	MCO770L15	71
MCO7A-5	50	MCO213-4	58, 60, 61	MCO340.....	73	MCO770L20.....	71
MCO7A6.....	50	MCO213-6.....	58	MCO341.....	73	MCO770L25.....	71
MCO7AMO	73	MCO214-13-10.....	23	MCO342	73	MCO770L30.....	71
MCO8	49	MCO214-13-20.....	23	MCO343	73	MCO770L35	71
MCO8B.....	49	MCO214-13-40.....	23	MCO351.....	72, 75	MCO770L40	71
MCO8BM	54	MCO214-13-60.....	23	MCO352-20	71	MCO771-2-5	40
MCO9	53	MCO214-13-80.....	23	MCO352-25.....	71	MCO771-3-0	40
MCO9-1.....	53, 67	MCO215.....	48	MCO352-30	71	MCO771-4-0	40
MCO10	48	MCO216-3-5	49	MCO352E20.....	71	MCO772	41
MCO10B	48	MCO218-4	58	MCO352E25	71	MCO773.....	42
MCO10M.....	48	MCO218-6.....	58	MCO352N20.....	71	MCO774-0-4.....	42
MCO10MO.....	73	MCO218-8.....	58	MCO352N25	71	MCO774-0-5.....	42
MCO12B	55	MCO221.....	51	MCO354	71	MCO774-0-6.....	42
MCO12D	55, 60	MCO221A.....	51	MCO357A	72	MCO774D8.....	42
MCO12E.....	55, 60, 61	MCO221MO	73	MCO366F10	43	MCO775-1	41
MCO12H.....	55, 60, 61	MCO222	46	MCO366F12	43	MCO776	41, 68
MCO12R	55	MCO224-2-0	49	MCO366F15	43	MCO781.....	5
MCO13A.....	44	MCO224A-2-0.....	49	MCO366F20.....	43	MCO782L.....	47
MCO13B.....	44	MCO224G	73	MCO367F10	71	MCO782R.....	47

^(D) Distributed by Integra MicroFrance SAS (France) - For corresponding manufacturer part numbers, see table in annex

MCO800	51	MCO981	10
MCO801	51	MCO981D	10
MCO802	51	MCO983-4	10
MCO803	13	MCO985	56
MCO804	53, 67	MCO988	14
MCO805	2	MCO989	54
MCO805A	2	MCO995	21
MCO806	52	MCO997	56
MCO806A	52	MCOP7A3	69
MCO806B	52	MCOP23A	70
MCO807	2, 52	MCOP23B	70
MCO813	51	MCOP25	70
MCO817	49	MCOP337A	69
MCO818	50	MCOP347A	69
MCO819	57	MCOP347B	69
MCO820	57, 60, 61	MCOP348A	69
MCO821-1	69, 77	MCOP348B	69
MCO824-1	77	MCOP348C	69
MCO830	55	MCOP348D	69
MCO832A	52	MCOP366A	70
MCO832B	52	MCOP366B	70
MCO832C	52	MCOP651	69
MCO832D	52	MCOP820	70
MCO841	52, 60, 61	MCOR20	55
MCO844	56	MCOR25	55
MCO865-1	77	MCOR30	55
MCO866	68	MCOR35	55
MCO890	42	MCOR40	55
MCO890-1-04	42	MCOR45	55
MCO890-1-08	42	MCOR50	55
MCO890-1-12	42	MCOR55	55
MCO890-1-15	42	MCOR60	55
MCO890-1-20	42	MCOR65	55
MCO901	51, 62	MCOR70	55
MCO904	62	MCOR75	55
MCO905	49, 62	MCOR80	55
MCO906	49, 62	MCOS14	74
MCO910M	62	MCOS15	74
MCO915	52, 62	MCOS16	74
MCO916	52, 62	MCOS17	74
MCO917	62	MCOS18	74
MCO918	62	MCOS19	74
MCO920	52, 62	MCOS20	74
MCO924	62	MCOS21	74
MCO925	62	MCOS22	74
MCO926	62	MCOS23	74
MCO928	62	MCOS25	74
MCO929	49, 62, 67	MCOS26	74
MCO932	62	MCOS27	74
MCO950	2, 52, 62	MCOS29	74
MCO951	49, 62	MCOS30	74
MCO960	44, 62	MCOS31	74
MCO961	44, 62	MCOS32	74
MCO970	53	MCOS33	74
MCO971T	53	MCOS34	74
MCO973T	53	MCOS35	74
MCO978	10	MCOS36	74
MCO978S	10		
MCO979	14		
MCO980	10		

N	
N480G	45

P	
P761-7	36
P761-8	36
P762-2	37
P762-4	37
P763	38
P764-1	37
P764-3	37
P764-5	37
P764-7	37
P764-11	37
P765-14	38
P765-16	38
P769	38

S	
SM63(D)	6
SM64(D)	6
SM65(D)	6

^(D) Distributed by Integra MicroFrance SAS (France) - For corresponding manufacturer part numbers, see table in annex



**Table for corresponding
manufacturer part numbers
For information purposes only**

Integra MicroFrance® product reference	Corresponding manufacturer part number
1003IG	M3IG
1003LI	M3LI
1004IG	M4IG
1005I	M5I
7872-24	1224
7875	1724
7876-100	310
7876-120	312
7876-160	316
7876-60	306
7876-80	308
9912-7	6617-7
9912-8	6617-8
9912-9	6617-9
9913-1	6611
9913-2	6612
9913-3	6613
9913-4	6614
9913-5	6615
9913-6	6616
SM63	SM63
SM64	SM64
SM65	SM65



Integra MicroFrance SAS (France)
Le Pavillon ■ 03160 Saint Aubin le Monial ■ France



Swann Morton Ltd
Penn Works ■ Owlerton Green ■ Sheffield
South Yorkshire S6 2BJ ■ Royaume Uni



Emergo Europe
Prinsessegracht 20 ■ 2514 AP The Hague
Pays-Bas

Manufacturers with CE Class I products only



Agencinox
Zone Industrielle
89110 Aillant sur Tholon ■ France



Concorde Import Export
B.P. 37
92300 Levallois-Perret ■ France

Availability of these products might vary from a given country or region to another, as a result of specific local regulatory approval or clearance requirements for sale in such country or region.

- Consult product labels and inserts for any indications, contraindications, hazards, warnings, precautions, and instructions for use.
- Non contractual document. The manufacturer reserves the right, without prior notice, to modify the products in order to improve their quality.
- Warning: Applicable laws restrict these products to sale by or on the order of a physician.

Additional information for EMEA Customers only :

Products mentioned in this document are CE class I, Im, IIa or IIb devices. Contact Integra should you need any additional information on devices classification.

All the medical devices mentioned on this document are CE marked in accordance with the applicable European laws, unless specifically identified as "NOT CE MARKED".

Products marked with the symbol^(®) are distributed by Integra MicroFrance SAS (France)

Date of last revision : 03/2023

For more information, please contact customer service :

Europe, Middle-East, Africa

International: +33 (0) 437 47 59 50 ■ +33 (0) 437 47 59 25 (Fax) ■ csemea@integralife.com
France: +33 (0) 437 47 59 10 ■ +33 (0) 437 47 59 29 (Fax) ■ custservfrance@integralife.com
United Kingdom: +44 (0) 1264 312 725 ■ +44 (0) 1264 312 821 (Fax) ■ custsvcs.uk@integralife.com
Belgium & Luxembourg: +32 (0)2 257 4130 ■ +32 (0)2 253 2466 (Fax) ■ custsvcbenelux@integralife.com
Netherlands: +31(0) 852 083 167 ■ +31(0) 207 093 627 (Fax) ■ custsvcnetherlands@integralife.com
Italy: +39 (0)2 577 8921 ■ +39 (0)2 575 113 71 (Fax) ■ custsvcitaly@integralife.com
integralife.eu/contact

Integra and the Integra logo are registered trademarks of Integra LifeSciences Corporation or its subsidiaries in the United States and/or other countries.

MicroFrance is a trademark of Integra LifeSciences Corporation or its subsidiaries.

All other trademarks and product names are the property of their respective owners.

©2023 Integra LifeSciences Corporation. All rights reserved.

0328571-6-EN

DOCUMENT FOR USE IN EUROPE, MIDDLE-EAST AND AFRICA ONLY.