



Integra[®] Jarit[®]

Laparoscopic Instruments

Guarantee/Warranty.....	2
One-Piece Laparoscopic Instrumentation.....	3
Grasping Forceps.....	4
Dissecting Forceps.....	16
Biopsy Forceps.....	19
Scissors.....	20
Needle Holders, Receivers, and Ligation.....	22
Suction/Irrigation.....	25
Retracting Instruments.....	26
Electrosurgical Coagulation.....	28
Specialization.....	30
Jarit Detach® System.....	33
Trocar/Cannula Systems.....	35
Storage and Accessories.....	37
Laparoscopes.....	38
3.5mm Laparoscopic Instruments.....	39
Replacement Parts Listing.....	43
Tip Comparison Chart.....	48
Numerical Index.....	52
Alphabetical Index.....	54

All Integra® Jarit® Instruments are unconditionally guaranteed against defects in material and workmanship. Integra will, at its option and without charge, either repair or replace any instrument which Integra determines to be defective in material or workmanship when used for its intended surgical purpose.

All instruments sold by Integra are warranted only to the original purchaser and only against defects in workmanship or materials which under the intended use render such instruments inoperable.

All Integra Jarit Carb-Bite™ and Carb-Edge™ instruments are further warranted for a period of three (3) years under normal use. Should any adjustment become necessary during this warranty period, CARB-EDGE Scissors will be resharpened, and Carb-Bite Needle Holder jaw inserts will be replaced without charge.

All Jarit Supercut™ Scissors are further warranted for a period of one year under normal use. Should any resharpening become necessary during this warranty period, Integra will provide this service without charge. A nominal charge will be made for sharpening after expiration of this warranty. Integra Jarit Supercut Scissors will be date-stamped for control.

The autoclavable feature of the Autoclavable Laparoscope is covered under a special one (1) year limited warranty.

This Guarantee/Warranty shall be void in the event any Integra instrument is used for purposes other than as originally intended, is not maintained or cleaned properly, is damaged as a result of misuse or accident or is repaired or altered by unauthorized persons.

The above is a limited warranty, and it is the only warranty made by Integra. Integra makes no other warranty, express or implied, including any warranty of merchantability or fitness for a particular purpose, as well as any express or implied warranty to patients. Integra shall have no liability for consequential, exemplary or incidental damages even if it is aware of the possibility of such damages. No warranty or guarantee may be created by any act or statement nor may this warranty be modified in any way, except as a result of a writing signed by an officer of Integra. These limitations on the creation or modification of this warranty may not be waived or modified orally or by any conduct. The stated express warranty is in lieu of all liabilities or obligations of Integra Jarit arising out of, or in connection with, the delivery, use or performance of any Integra instrument. Integra neither assumes nor authorizes any representative or other person to assume for it any other liability in connection with Integra's products.

All products are subject to slight changes in dimensions and finishes due to changes in manufacturing standards.

Ordering Procedure

A written purchase order on customer's form may be requested for purchase of Integra products.

Acceptance of Order

Orders are accepted upon approval by Integra.

Returned Goods Policy

Products must be returned in unopened packages with manufacturer's seals intact to be accepted for replacement or credit unless returned due to a complaint of product defect. Determination of a product defect will be made by Integra. Products will not be accepted for replacement if they have been in the possession of the customer for more than 90 days.

Repairs and Maintenance

Should your instruments require repair or maintenance, contact Integra for return authorization and address. Instruments returned to Integra for repair must have a statement testifying that each instrument has been thoroughly cleaned and sterilized. Failure to supply evidence of cleaning and disinfection will result in a cleaning charge and delayed processing of your instrument repair.

Product Information Disclosure

Integra and its subsidiaries ("Integra") and manufacturer exclude all warranties, except Integra's applicable standard warranty whether expressed or implied, including but not limited to, any implied warranties of merchantability or fitness for a particular purpose. Neither Integra nor manufacturer shall be liable for any incidental or consequential loss, damage, or expense, directly or indirectly arising from use of these products. Neither Integra nor manufacturer assume nor authorize any person to assume for them any other or additional liability or responsibility in connection with these products.

Care and Handling/IFU

For Care and Handling information and Instructions for use, please visit integralife.com/jarit.

Manufacturer:



Integra LifeSciences Production Corporation
11 Cabot Boulevard
Mansfield, MA 02048 USA

One-Piece

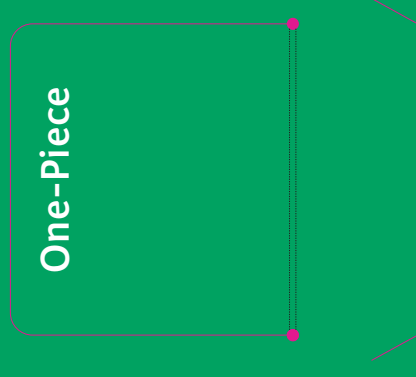

One-Piece

One-Piece

One-Piece

Stringent quality standards are the most important aspect in the development of Integra Jarit instruments. Laparoscopic instruments are designed, manufactured and tested to provide surgeons with superior performance and dependability. High grade surgical stainless steel, used in the manufacture of all Integra Jarit laparoscopic instruments, offers high tensile strength and durability. For effective and efficient processing, instruments are made with internal seals. To confirm electrosurgical safety, electrosurgical instruments are tested per IEC International Electromechanical Commission standards. Integra Jarit offers laparoscopic instruments with a choice of features to meet both the preference of the surgeon and the economic demands of the hospital.

Rotation

The Jarit Rotator™ design provides comfortable, single-handed, bi-directional rotation of the distal tip. The Rotator instruments offer exclusive features to meet the technical requirements of blunt dissection, sharp dissection and grasping. Precise German engineering, combined with handcrafted workmanship, has resulted in the features of the Roto-Lok™ design for grasping forceps and the Roto-Cam™ design for dissectors and scissors.

Roto-Lok: When the traction/countertraction technique is applied during dissection, it is important to maintain an effective grasp on tissue. If the instrument rotates freely, the distal tip could slip, making dissection difficult. With Integra Jarit’s unique Roto-Lok feature, rotation locks into place once the tissue is grasped. The result is a secure grasp that will not slip or spin.

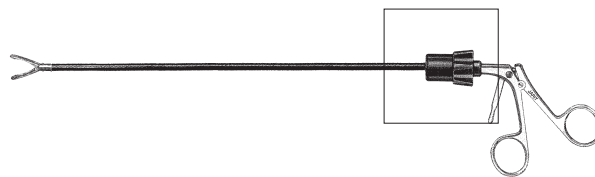

Roto-Cam: The Roto-Cam design for dissectors and scissors allows the surgeon to easily turn the rotating wheel, yet provides enough tension to prevent unnecessary movement. The design enables rotation in both open and closed positions to facilitate precise dissection.

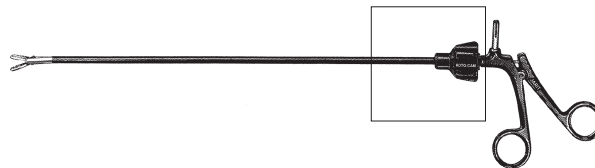

Locking Mechanisms

Computer-generated production techniques employed in the precisely calibrated ratchet, hinge and locking mechanisms result in smooth, secure jaw closure.

Ratchet: The advanced design of the half-moon ratchet offers fine-teeth and a sturdy leaf-spring that is specially manufactured to maintain a firm hold.



Locking Lever: As an alternative to the ratchet, the sophisticated Integra Jarit locking lever engages and releases easily, yet maintains a firm hold. The locking lever offers the surgeon the ability to open and close the jaws freely, locking only when the surgeon chooses to engage the lever. The unique internal design adds built-in strength for a long, useful life.



Slide Lock: Featuring an ergonomic handle design, the slide locking mechanism is a different style of ratchet. It allows surgeons to operate the jaws freely until the sliding ratchet mechanism is engaged.



Integra Jarit grasping forceps feature a hinge mechanism to assure strength and durability. Precisely calibrated ratchets provide smooth, gradual closure of jaws. The easy-release locking lever offers the surgeon the ability to open and close the jaws freely, locking only when the lever is engaged.



Grasping Forceps

Straight, serrated jaws with proximal recess, double action.



600-100
Ratchet,
insulated shaft,
5mm, 332.5mm
12.5mm jaw



610-100
Roto-Lok
Slide lock,
insulated shaft,
5mm, 321mm
14mm jaw



605-100
Slide lock,
insulated shaft,
5mm, 322mm
14mm jaw



625-100
Roto-Lok,
ratchet,
insulated shaft,
5mm, 334mm
14mm jaw



625-100LL
Roto-Lok,
locking lever,
insulated shaft,
5mm, 334mm
14mm jaw

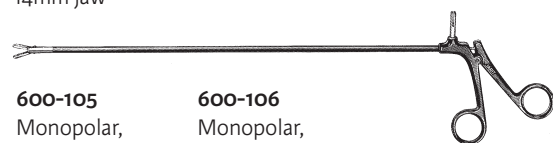

600-105
Monopolar,
5mm, 332.5mm
12.5mm jaw

600-106
Monopolar,
5mm, 462.5mm
12.5mm jaw



625-105
Roto-Cam,
monopolar,
5mm, 342.5mm
12.5mm jaw

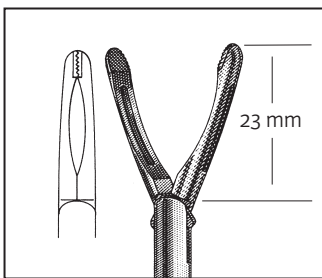

TC Grasping Forceps

Uniquely designed grasping forceps feature double action Carb-Bite™ tips.



625-102
Roto-Lok,
ratchet,
insulated shaft,
5mm, 343mm



625-102LL
Roto-Lok,
locking lever,
insulated shaft,
5mm, 343mm

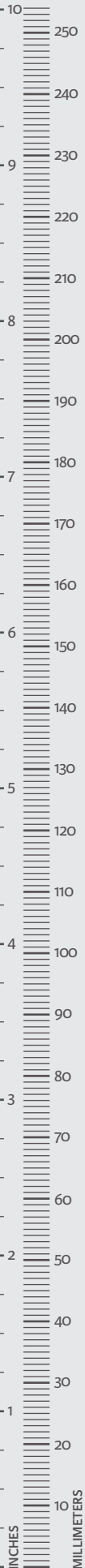

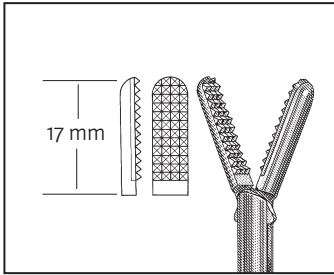

Strong TC Grasping Forceps

Heavy Carb-Bite inserts, double action.

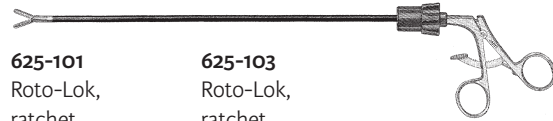

625-101
Roto-Lok, ratchet, insulated shaft, 5mm, 326mm

625-103
Roto-Lok, ratchet, insulated shaft, 5mm, 377mm



625-103LL
Roto-Lok, locking lever, insulated shaft, 5mm, 377mm

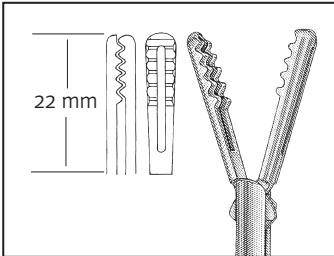

Grabber Forceps

Long, fenestrated jaws with interlocking wave-like serrations, double action.



610-104
Roto-Lok, slide lock, insulated shaft, 5mm, 380mm



600-104IL
In-line, ratchet, insulated shaft, 5mm, 378mm

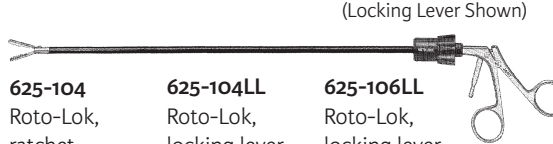

(Locking Lever Shown)

625-104
Roto-Lok, ratchet, insulated shaft, 5mm, 382mm

625-104LL
Roto-Lok, locking lever, insulated shaft, 5mm, 382mm

625-106LL
Roto-Lok, locking lever, insulated shaft, 5mm, 462mm

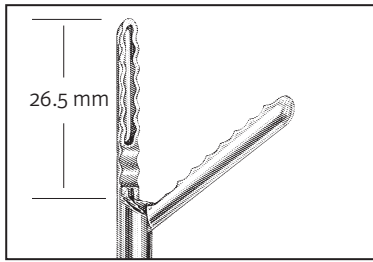

Fundus Grasping Forceps
Long, beveled-edge jaws.

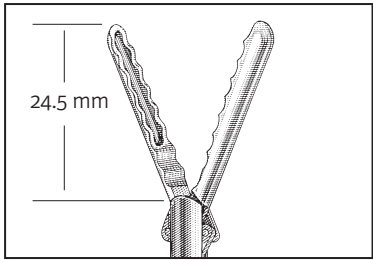

625-107DA
Double action, Roto-Lok, locking lever, insulated shaft, 5mm, 384mm

625-107RD
Double action, Roto-Lok, ratchet, insulated shaft, 5mm, 384mm

625-107D5
Double action, Roto-Lok, locking lever, insulated shaft, 5mm, 464mm

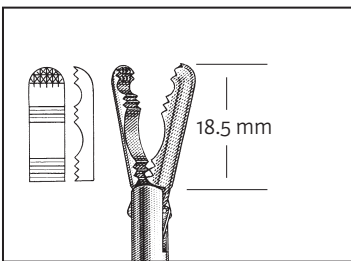

Dual-Cup Grasping Forceps
Double cup design increases surface area contact, double action.



610-107
Roto-Lok, slide-lock, insulated shaft, 5mm, 381mm



610-107DA
Double action, Roto-Lok, slide lock, insulated shaft, 5mm, 382mm

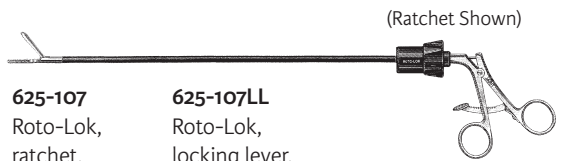

625-107
Roto-Lok, ratchet, insulated shaft, 5mm, 383mm

625-107LL
Roto-Lok, locking lever, insulated shaft, 5mm, 383mm



600-107IL
Double action, in-line, ratchet, insulated shaft, 5mm, 380mm



610-108
Roto-Lok, slide lock, insulated shaft, 5mm, 326mm

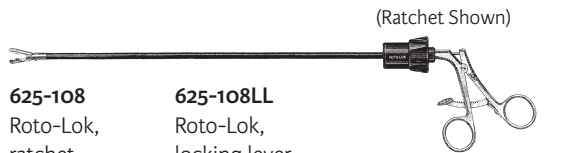

625-108
Roto-Lok, ratchet, insulated shaft, 5mm, 338mm

625-108LL
Roto-Lok, locking lever, insulated shaft, 5mm, 338mm



600-108IL
In-line, ratchet, insulated shaft, 5mm, 374mm

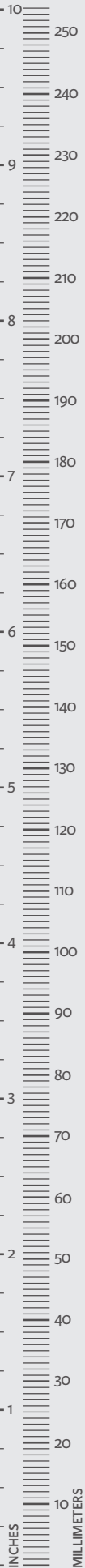

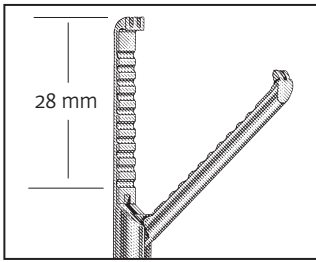

Retraction Grasping Forceps
Long-ridged jaws with 2x3 blunt interdigitating teeth.

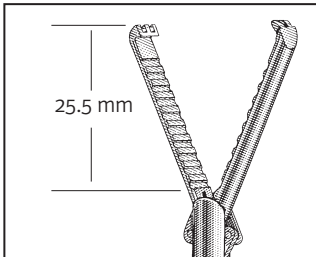

625-109
Roto-Lok, ratchet, insulated shaft, 5mm, 383mm

625-109LL
Roto-Lok, locking lever, insulated shaft, 5mm, 383mm



625-109DA
Double action, Roto-Lok, locking lever, insulated shaft, 5mm, 386mm

625-109RD
Double action, Roto-Lok, ratchet, insulated shaft, 5mm, 386mm

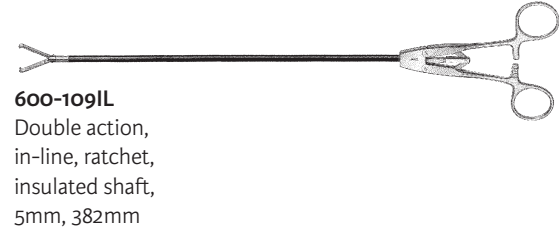

600-109IL
Double action, in-line, ratchet, insulated shaft, 5mm, 382mm

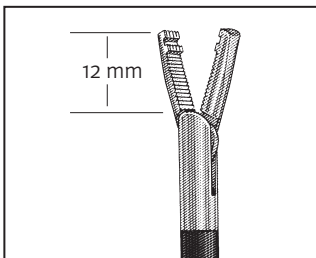

Atrau-Allis Grasping Forceps
Unique jaw design offers strong atraumatic grasp, double action.



625-113
Roto-Lok, ratchet, insulated shaft, 5mm, 332mm

625-113LL
Roto-Lok, locking lever, insulated shaft, 5mm, 332mm



600-113
Ratchet, insulated shaft, 5mm, 332mm

600-114
Ratchet, insulated shaft, 5mm, 452mm

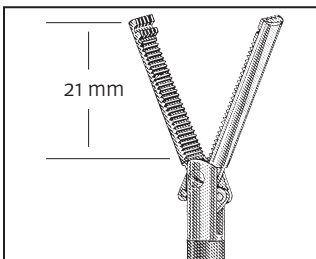

Atrau-Allis Long Jaw Grasping Forceps
Unique jaw design offers strong atraumatic grasp, double action.



625-114
Roto-Lok, ratchet, insulated shaft, 5mm, 381mm

625-114LL
Roto-Lok, locking lever, insulated shaft, 5mm, 381mm

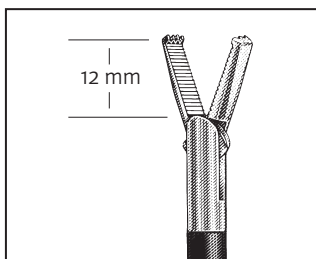

Allis Grasping Forceps
Interlocking distal teeth with fine-serrated inner jaws, double action.



600-122
Ratchet, insulated shaft, 5mm, 332mm

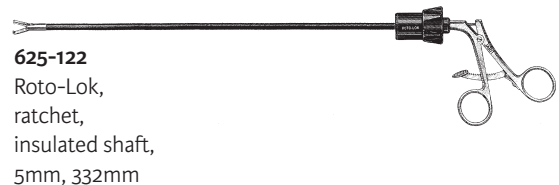

625-122
Roto-Lok, ratchet, insulated shaft, 5mm, 332mm

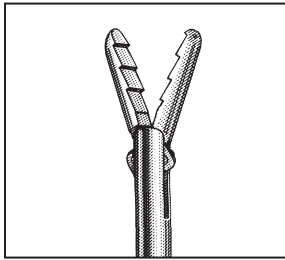

Retrograde Grasping Forceps
Retrograde, deep-serrated teeth, double action.

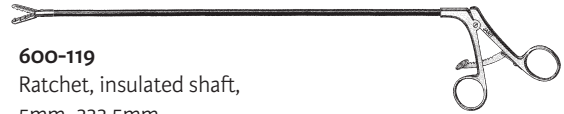

600-119
Ratchet, insulated shaft, 5mm, 333.5mm
13.5mm jaw

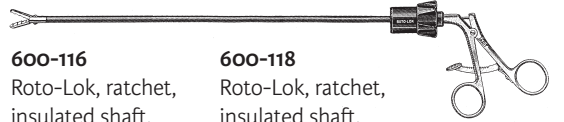

600-116
Roto-Lok, ratchet, insulated shaft, 5mm, 331mm
15mm jaw

600-118
Roto-Lok, ratchet, insulated shaft, 5mm, 462mm
15mm jaw

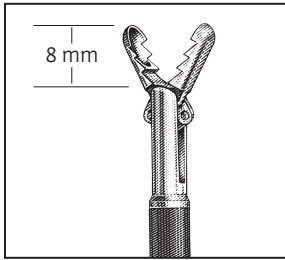

Grasping and Dissecting Forceps
Cup-shaped, toothed jaws, double action.



600-120
Monopolar, 5mm, 328mm

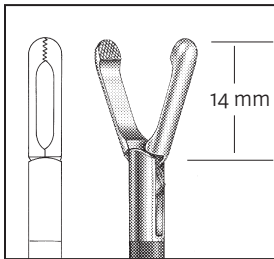

Winer Grasping Forceps
Cross-serrated, disc-shaped jaws with wide opening between the jaws, in-line ratcheted handle.



600-123
In-line, ratchet, insulated shaft, 5mm, 344mm

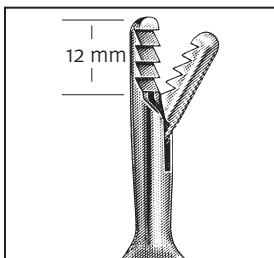

Grasping and Extracting Forceps
Retrograde, deep-serrated teeth.

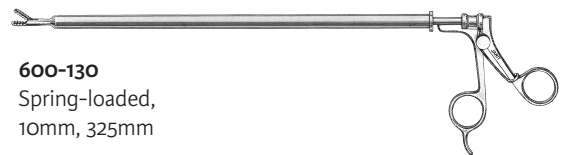

600-130
Spring-loaded, 10mm, 325mm

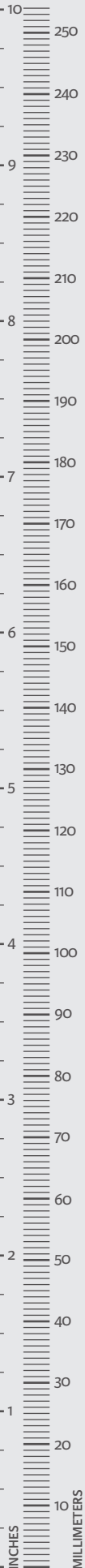

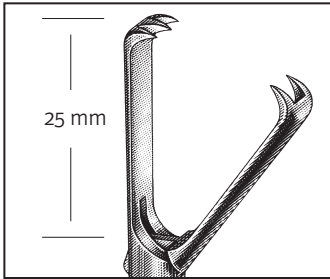

Claw Forceps
2x3 interlocking teeth for penetrating hold and extraction of tissue.

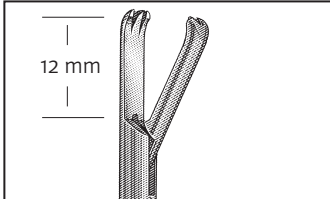

Claw Forceps
2x3 interlocking teeth for penetrating hold and extracting tissue.

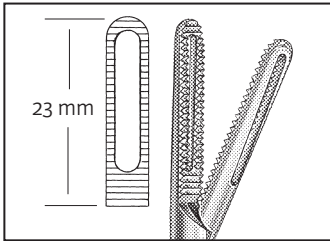

DJB Grasping Forceps
Wide fenestration and straight fine serrations of single action jaws.

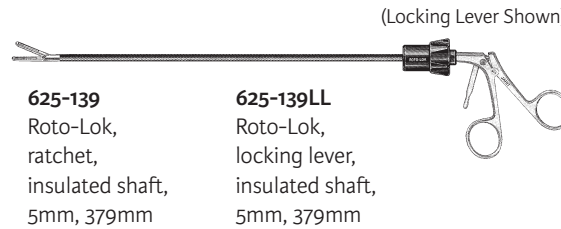

DeBakey Forceps
Fenestrated 40mm long jaws with DeBakey-type teeth, double action.

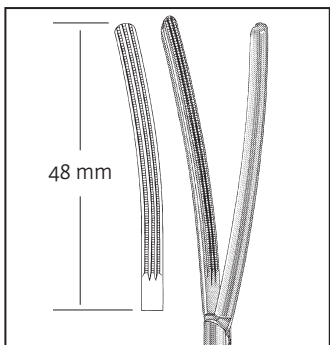

DeBakey Forceps, Curved
48mm long jaws with DeBakey-type teeth, double action.



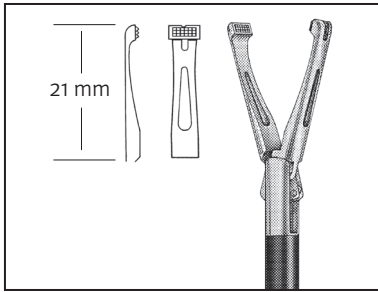

Strong Hold Babcock Forceps

Traditional design, double action.



610-149
Roto-Lok, slide lock, insulated shaft, 5mm, 379mm

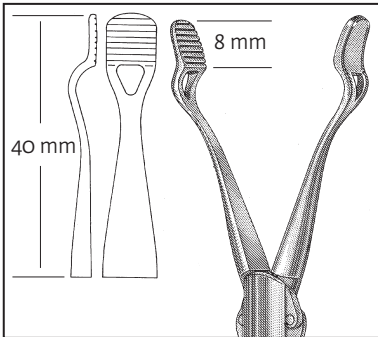

Paddle Babcock Forceps, 10mm

Flat paddles with fine, straight serrations, double action.



625-142
Roto-Lok, ratchet, 10mm, 370mm

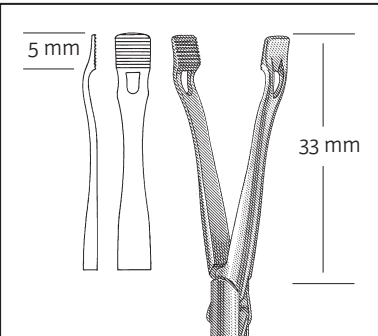

Paddle Babcock Forceps, 5mm

Flat paddles with fine, straight serrations, double action.

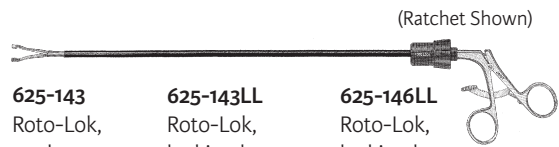

625-143
Roto-Lok, ratchet, insulated shaft, 5mm, 393mm

625-143LL
Roto-Lok, locking lever, insulated shaft, 5mm, 393mm

625-146LL
Roto-Lok, locking lever, insulated shaft, 5mm, 473mm



600-143IL
In-line, insulated shaft, ratchet, 5mm, 389mm

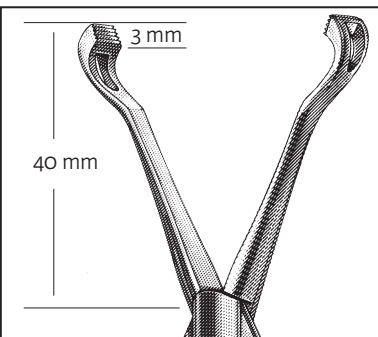

Babcock Forceps

Traditional style Babcock jaws designed with six rows of fine serrations, double action.



625-144
Roto-Lok, ratchet, 10mm, 370mm

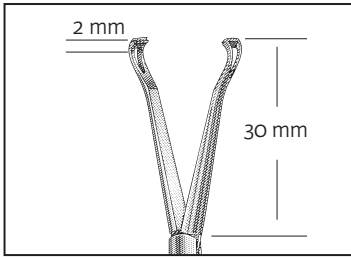

Babcock Forceps, 5mm
Traditional design, double action.



600-147
Ratchet, insulated shaft, 5mm, 350mm

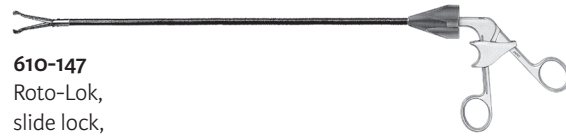

610-147
Roto-Lok, slide lock, insulated shaft, 5mm, 388mm

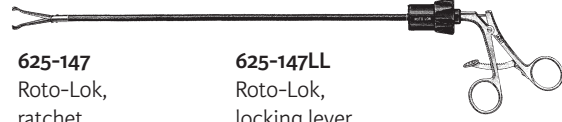

625-147
Roto-Lok, ratchet, insulated shaft, 5mm, 390mm

625-147LL
Roto-Lok, locking lever, insulated shaft, 5mm, 390mm

(Ratchet Shown)

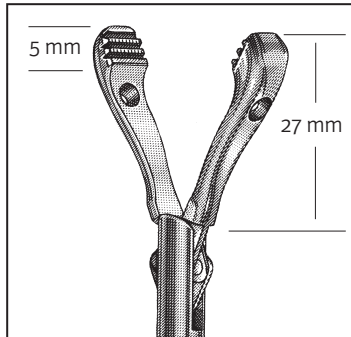

Babcock Forceps, Round Jaw
Rounded jaws with 2x3 rows of DeBakey-type teeth, double action.



600-145
Ratchet, 10mm, 346mm



625-145
Roto-Lok, ratchet, 10mm, 330mm

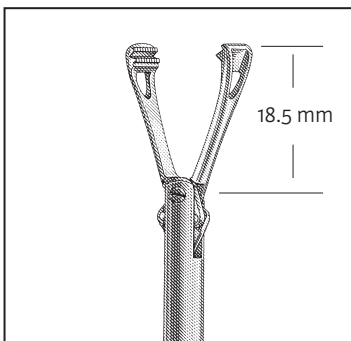

Swanström Grasping Forceps
Unique design of 1x2 DeBakey-type teeth with triangular fenestration, double action.



610-148
Roto-Lok, slide lock, insulated shaft, 5mm, 376mm

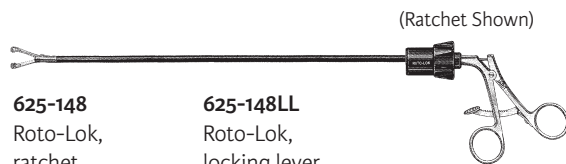

625-148
Roto-Lok, ratchet, insulated shaft, 5mm, 378mm

625-148LL
Roto-Lok, locking lever, insulated shaft, 5mm, 378mm

(Ratchet Shown)



600-148IL
In-line, insulated shaft, ratchet, 5mm, 374mm

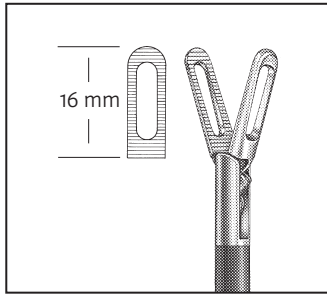

Duckbill Grasping Forceps
Wide fenestration and straight serrations of jaws.

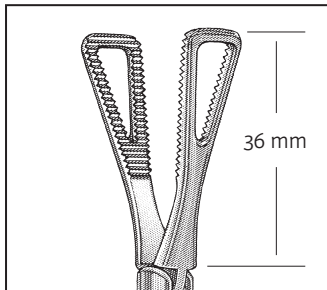

Duval Grasping Forceps
Triangular jaws with deep-serrated surfaces, double action.

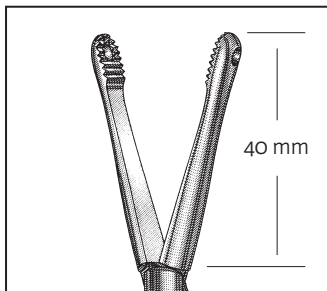
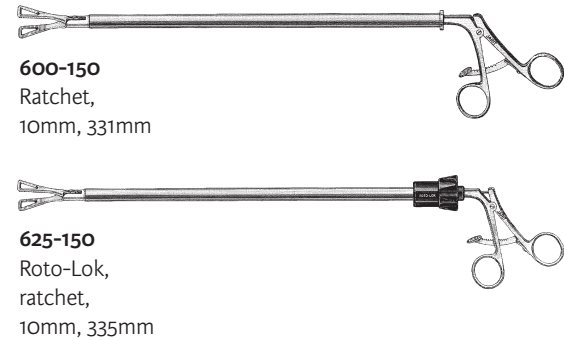

Russian Grasping Forceps
40mm long jaws with heavy serrations, double action.

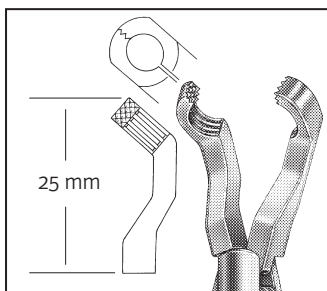

Anvil Grasping Forceps
Jaws specially shaped to grasp and hold the anvil of a circular stapler.

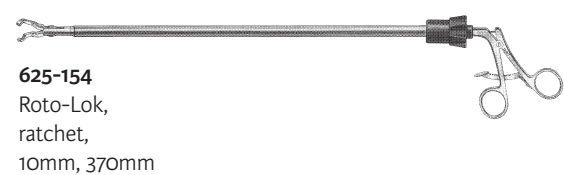

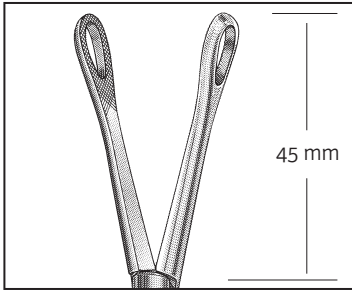

**Foerster
Sponge Forceps**
45mm jaws,
double action.



600-158
Ratchet,
10mm, 335mm

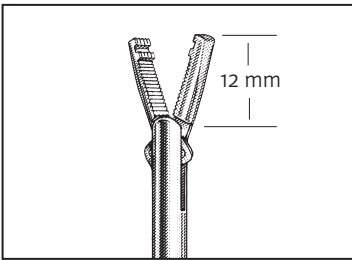

Hunter Clamp
Right-angle shaft with
Atrau-Allis teeth,
double action.



50 mm
600-160
Ratchet,
5mm, 321mm

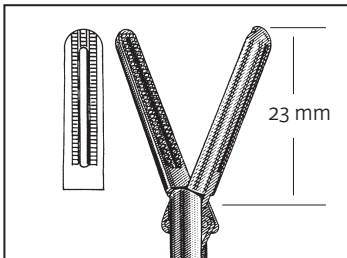

Hunter Bowel Grasper
Fenestrated jaws with
DeBakey-type teeth,
double action.

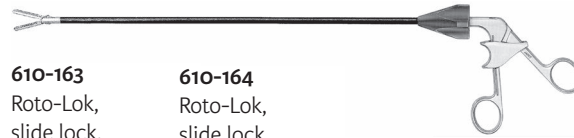

610-163
Roto-Lok,
slide lock,
insulated shaft,
5mm, 330mm

610-164
Roto-Lok,
slide lock,
insulated shaft,
5mm, 381mm

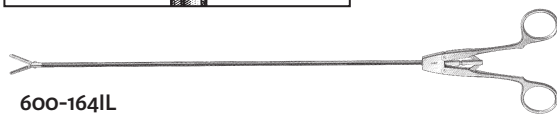

600-164IL
In line,
non-ratcheted
insulated shaft,
5mm, 379mm

610-165
Roto-Lok,
slide lock,
insulated shaft,
5mm, 457mm

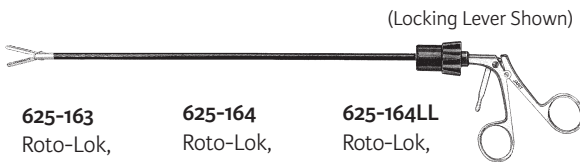

(Locking Lever Shown)

625-163
Roto-Lok,
non-locking,
insulated shaft,
5mm, 322mm

625-164
Roto-Lok,
non-locking,
insulated shaft,
5mm, 383mm

625-164LL
Roto-Lok,
locking lever,
insulated shaft,
5mm, 383mm



610-166
Roto-Lok,
slide lock,
insulated shaft,
5mm, 403mm,
45mm jaw length

625-165LL
Roto-Lok,
locking lever,
insulated shaft,
5mm, 463mm

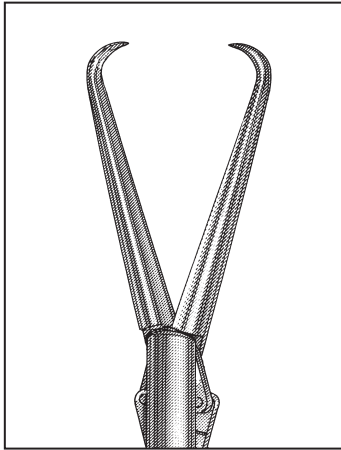

Tenaculum Forceps

Single-toothed long jaws, double action.



605-152
Slide Lock, insulated shaft, 5mm 339mm 31mm jaw



615-150
Ratchet, insulated shaft 10mm, 363mm 37mm jaw

615-152
Ratchet insulated shaft 5mm, 350mm 31mm jaw

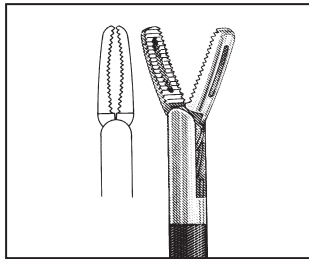

Strong Forceps

Fenestrated, serrated, oval-shaped jaws that converge at distal end, double action.

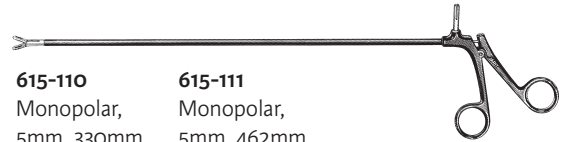

615-110
Monopolar, 5mm, 330mm 12mm jaw

615-111
Monopolar, 5mm, 462mm 12mm jaw

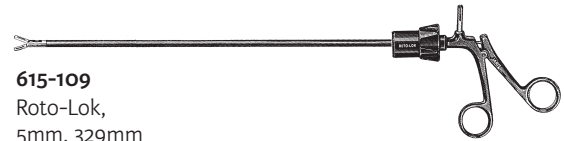

615-109
Roto-Lok, 5mm, 329mm 13.5mm jaw

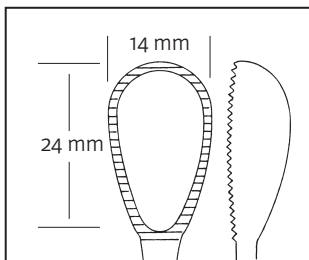

Stone Extractor

To facilitate stone removal once neck of gallbladder has been externalized.

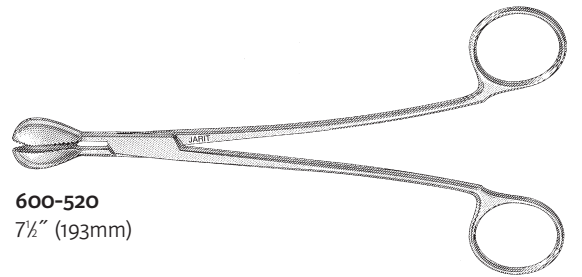

600-520
7 1/2" (193mm)

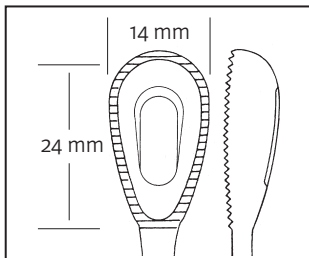

Lobe Spleen Extractor

Open cupped jaws for extraction of the spleen during laparoscopic splenectomy.

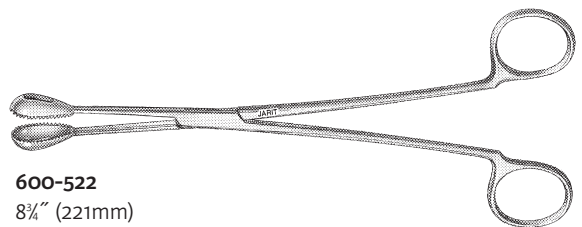

600-522
8 1/4" (221mm)

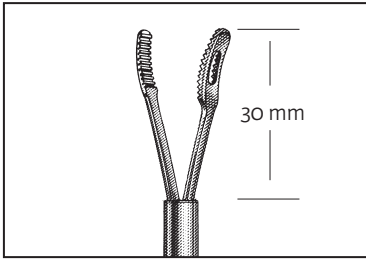

Strong Atraumatic Grasping Forceps

Fenestrated, serrated, curved jaws with split-steel construction.



615-113
Spring handle,
5mm, 340mm

615-114
Spring handle,
5mm, 480mm

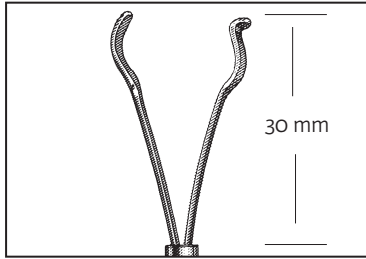

Grasping Forceps, Fallopian Tube

Curved jaws with split-steel construction.



615-116
Spring handle,
5mm, 340mm

615-118
Spring handle,
5mm, 460mm

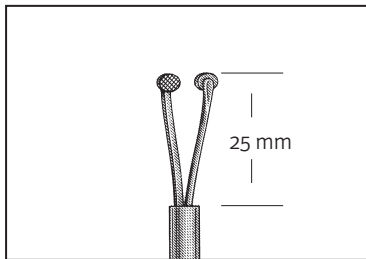

Bowel Forceps

Cross-serrated, disc-shaped jaws with split-steel construction.



615-143
Spring handle,
5mm, 336mm

615-144
Spring handle,
5mm, 456mm

Integra Jarit dissecting forceps are specially designed with the varied needs and preferences of the surgeon in mind — from fine, precise dissection around delicate tissue to gross dissection of large structures.

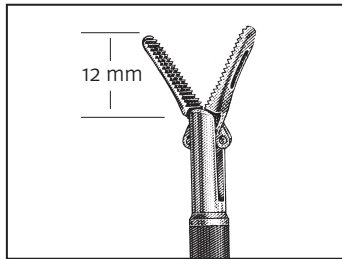

Micro Dissecting Forceps

Delicate, fenestrated, serrated jaws, double action.



600-110
Monopolar,
5mm, 332mm

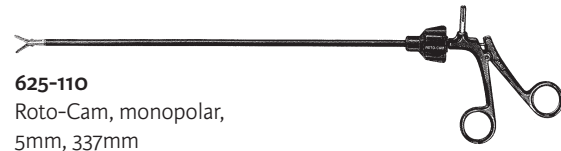

625-110
Roto-Cam, monopolar,
5mm, 337mm

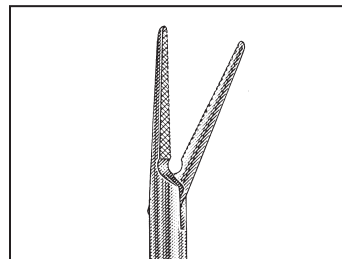

Needle Nose Forceps

Slender, tapered and fine-serrated jaws.



600-112
Monopolar,
5mm, 330mm
18.5mm jaw



625-112
Roto-Cam,
monopolar,
5mm, 345mm
19mm jaw

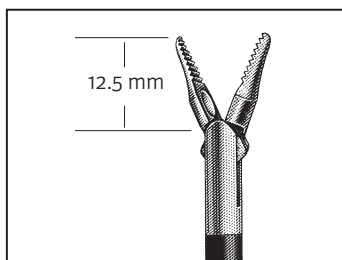

Tapered Dissecting Forceps

Tips of serrated, tapered jaws meet at fine point, double action.



600-115
Monopolar,
5mm, 332.5mm



625-115
Roto-Cam,
monopolar,
5mm, 342.5mm

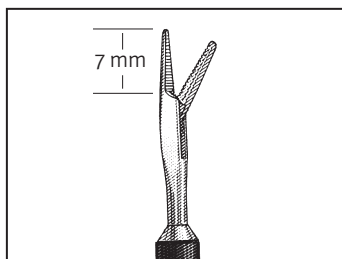

Micro Grasping Forceps

Slender, tapered jaws for dissection of small structures.



600-117
Monopolar,
5mm, 330mm

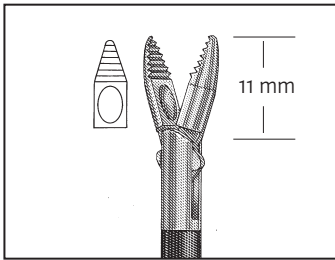

Bullet-Nose Dissecting Forceps
Bullet-shaped, tapered, serrated jaws for dissection, double action.



625-117
Roto-Cam, monopolar, 5mm, 341mm

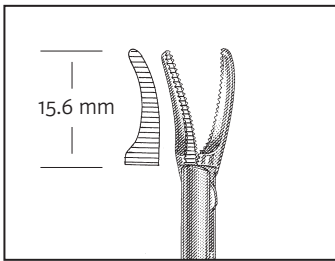

Tapered Maryland Dissector
Curved, finely-tapered, serrated jaws with wide spread, double action.



625-124
Roto-Cam, monopolar, 5mm, 345.5mm

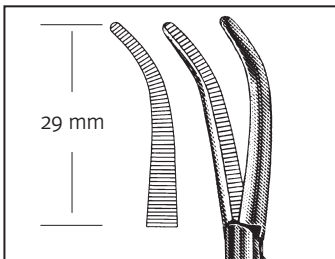

Maryland Dissector
Slender, full-curved, long, serrated jaws with wide spread, double action.



625-125
Roto-Cam, monopolar, 10mm, 339mm

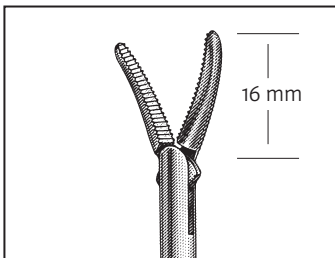

Maryland Dissectors
Curved, tapered, serrated jaws with wide spread, double action.



600-126
Monopolar, 5mm, 326mm



600-125
Monopolar, 10mm, 325mm

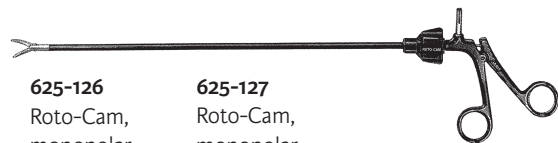

625-126 **625-127**
Roto-Cam, Roto-Cam,
monopolar, monopolar,
5mm, 346mm 5mm, 450mm

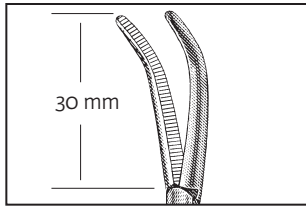

Mixer Dissecting Forceps

Slender, full-curved, long, serrated jaws with wide spread, double action.



600-127
10mm, 335mm

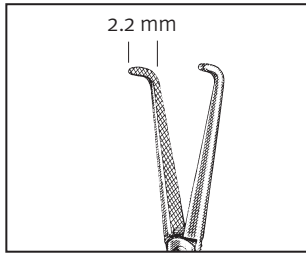

Mixer Spreader-Dissectors

Jaw design offers a true right-angle for dissection around delicate structures, double action.



625-128
Roto-Cam, monopolar, 10mm, 320mm 26mm jaw



600-128
10mm, 322mm 27mm jaw



625-128RH
Roto-Cam, monopolar, ring-handle, 10mm, 319mm 26mm jaw

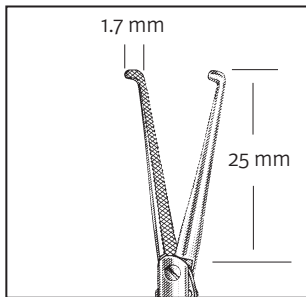

Mixer Spreader-Dissectors

Jaw design offers a true right-angle for dissection around delicate structures; double action.



625-129
Roto-Cam, monopolar, 5mm, 320mm

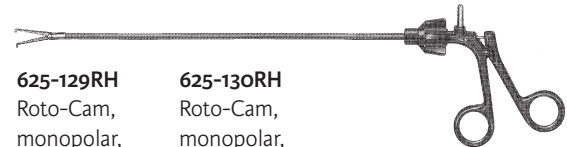

625-129RH **625-130RH**
Roto-Cam, monopolar, ring-handle, 5mm, 318mm Roto-Cam, monopolar, ring-handle, 5mm, 463mm

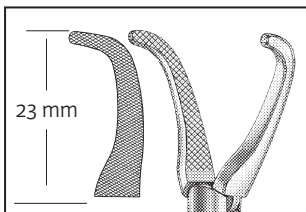

Right Angle Dissector

Cross-serrated jaws with full right angle; double action



625-132
Roto-Cam, monopolar, 10mm, 360mm

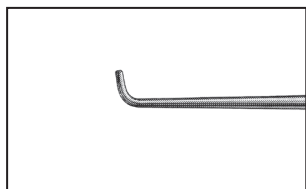

Appel Dissecting Hook

Right-angle tip allows blunt dissection and isolation of structures.



56 mm
600-500
10mm, 406.5mm

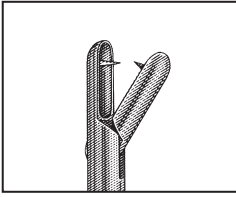

Biopsy Forceps

Two sharp teeth, one on each jaw, for biopsy or hold of thick-walled tissue.

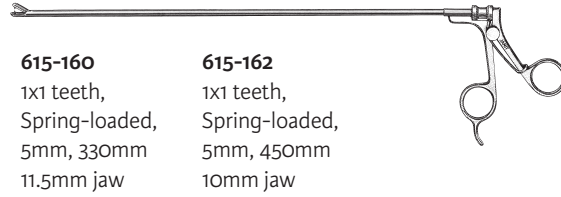

615-160

1x1 teeth,
Spring-loaded,
5mm, 330mm
11.5mm jaw

615-162

1x1 teeth,
Spring-loaded,
5mm, 450mm
10mm jaw

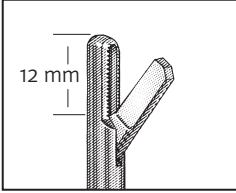

Biopsy Punches

Serrated lower jaw.

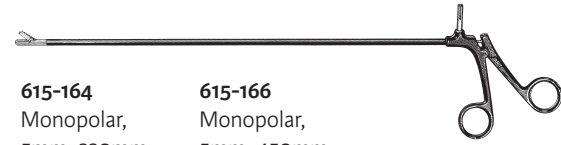

615-164

Monopolar,
5mm, 330mm

615-166

Monopolar,
5mm, 450mm

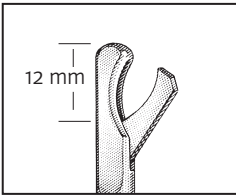

Hook Biopsy Punches

Frangenheim-type electro-surgical biopsy punch with hook blade.

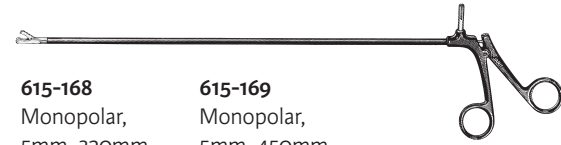

615-168

Monopolar,
5mm, 320mm

615-169

Monopolar,
5mm, 450mm

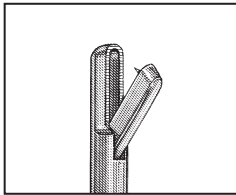

Biopsy Punches

Single tooth in upper jaw.

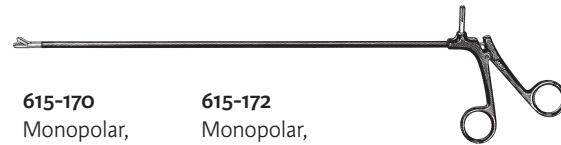

615-170

Monopolar,
5mm, 330mm
9.5mm jaw

615-172

Monopolar,
5mm, 450mm
12mm jaw

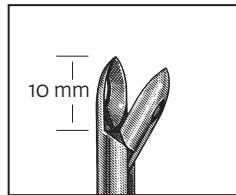

Biopsy Forceps

Oval-shaped fenestrated jaws.



615-174

Monopolar,
5mm, 325mm

615-176

Monopolar,
5mm, 445mm

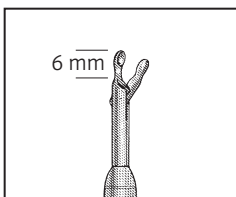

Micro Biopsy Forceps

For biopsy of small, delicate tissues.

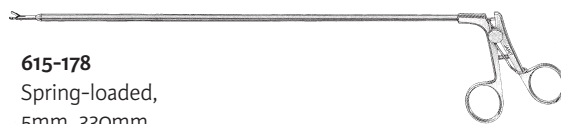

615-178

Spring-loaded,
5mm, 330mm

The Integra Jarit scissors line was developed by utilizing advanced metallurgy, as well as innovative methods of grinding and sharpening. The result — scissors that cut cleanly and stay sharp.

The exclusive Integra Jarit Supercut™ blade is razor sharp and glides effortlessly through tissue with a clean, precise cut. The finely-serrated lower blade helps prevent tissue slippage.

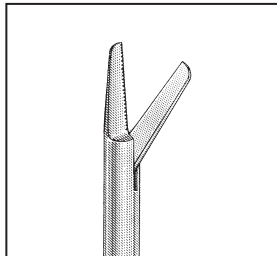

Supercut Scissors

Razor-sharp upper blade with finely-serrated lower blade.



600-200 5mm, 330mm
600-201 5mm, 450mm



625-200
Roto-Cam, monopolar, 5mm, 343mm

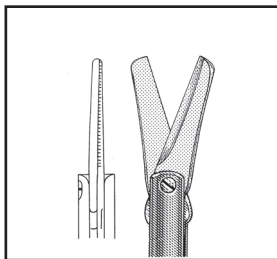

Supercut Endo Scissors, Straight

Electrosurgical instrument with straight, Integra Jarit Supercut blades and precise cutting action offers mechanical cutting, electro-surgical cutting, blunt dissection, electro-surgical coagulation—all in one reusable, cost-effective instrument; double action.



625-201
Roto-Cam monopolar, 5mm, 343.5mm

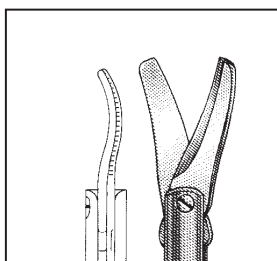

Supercut Endo Scissors, Curved

Electrosurgical instrument with curved, Integra Jarit Supercut blades and precise cutting action offers mechanical cutting, electro-surgical cutting, blunt dissection, electro-surgical coagulation—all in one reusable, cost-effective instrument; double action.

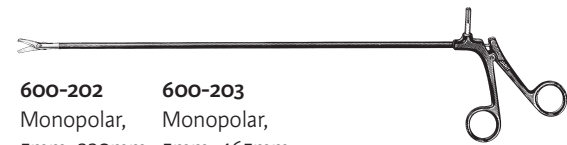

600-202 Monopolar, 5mm, 330mm
600-203 Monopolar, 5mm, 465mm

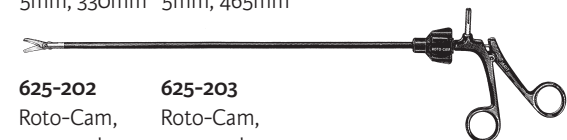

625-202 Roto-Cam, monopolar, 5mm, 344mm
625-203 Roto-Cam, monopolar, 5mm, 454mm

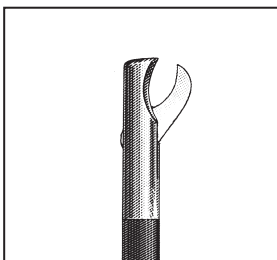

Hook Scissors

Blades designed to lift, isolate and transect tissue.

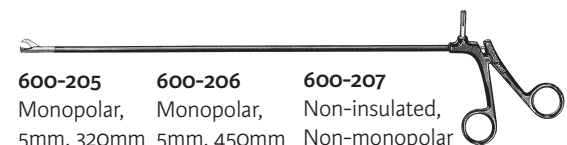

600-205 Monopolar, 5mm, 320mm
600-206 Monopolar, 5mm, 450mm
600-207 Non-insulated, Non-monopolar 5mm, 325mm



625-205
Roto-Cam, monopolar, 5mm, 330mm

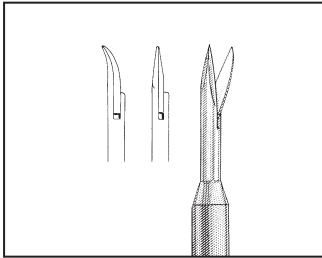

Micro Scissors
Fine, delicate, 3mm blades for small incision.



600-210
Curved Left,
5mm, 333mm

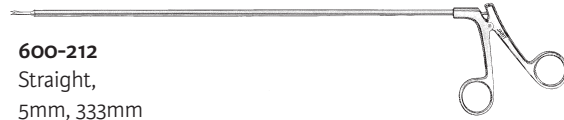

600-212
Straight,
5mm, 333mm

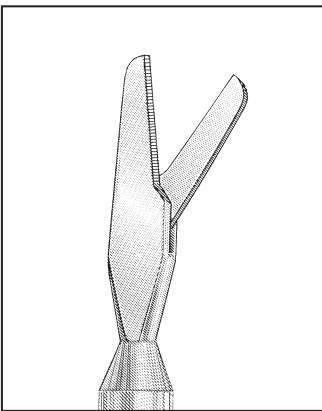

Mayo Operating Scissors
Large, sturdy blades for incising heavy tissue.



600-220
10mm, 330mm

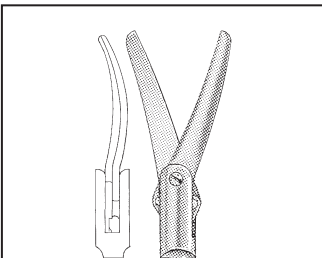

Metzenbaum Scissors
Long, curved, tapered blades with wide spread, double action.



625-230
Roto-Cam,
monopolar,
5mm, 338mm

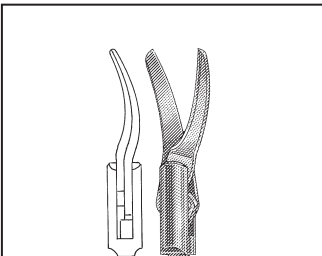

Mini Scissors
Curved, tapered, delicate blades, double action.



625-240
Roto-Cam,
monopolar,
5mm, 335mm

The difficult task of laparoscopic suturing is more manageable with Integra Jarit's Ligation Line of unique instruments for both intracorporeal and extracorporeal suturing. The line features the Appel Needle Holders, which give the surgeon improved control of curved needles. These high quality laparoscopic instruments offer an ergonomically designed handle that places the surgeon's hand in line with the needle, resulting in a natural suturing motion, along with a leaf-spring mechanism that is engaged with speed and ease. The curved, tapered jaws permit fine control of the needle together with improved visibility at the suture site. Integra Jarit's Carb-Bite jaws allow for a firm, secure grip on the needle and long, useful life of the instrument. Alternative needle holder options include the In-line ring-handle Needle Holder and the Self-Righting Romeo Needle Holder.

Also featured are the Lyons Needle Forceps and Juliet Receiving Forceps. These unique instruments are specially designed to work in conjunction with the needle holder to achieve an efficient laparoscopic suturing technique. Functioning as a tissue forceps, the tapered jaws grasp and retract tissue for needle placement without obstructing visualization. Functioning as a receiver, the driven needle is grasped at the tip. The design then allows the needle to be easily repositioned within the jaw for re-grasping by the needle holder at the appropriate angle.

Appel Needle Holders

Tapered jaws stabilize the needle while allowing better visibility at the suture site; Carb-Bite jaws are designed for a firm, secure grip on the needle and long life of the instrument.

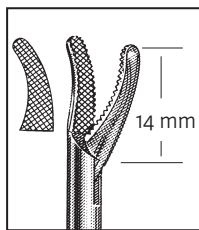
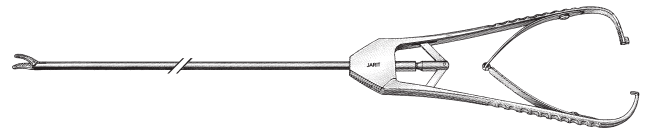

600-250
Left Curve,
5mm, 330mm
600-249
Left Curve, 5mm, 450mm

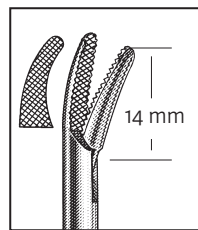

600-252
Right Curve,
5mm, 330mm

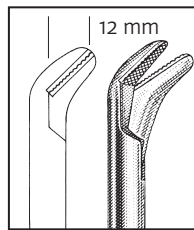

600-255
Up-Angle,
10mm, 330mm

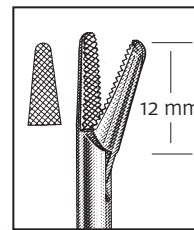

600-260
Straight,
5mm, 330mm

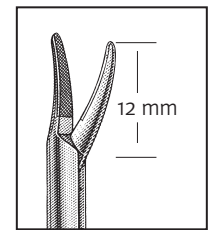

600-264
Micro, Left Curve,
5mm, 330mm

**In-line Carb-Bite
Needle Holders**

In-line ring handle offers a handle design similar to that used in open surgery with the same superior hold of needles.

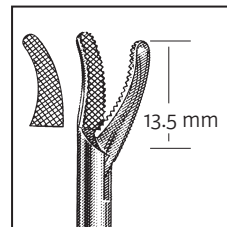
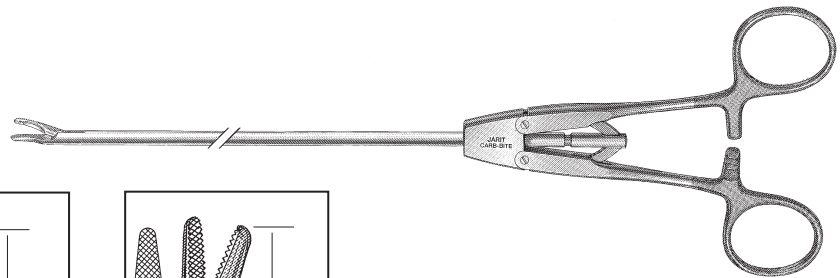

600-251
Left Curve,
5mm, 330mm

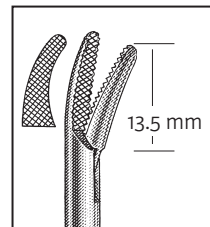

600-253
Right Curve,
5mm, 330mm

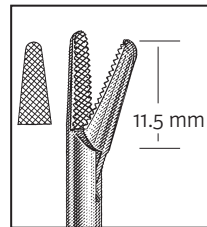

600-261
Straight,
5mm, 330mm

600-254
Left Curve, 5mm, 450mm

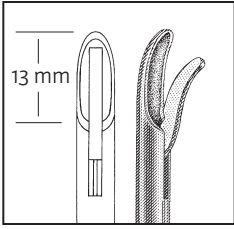

Romeo Self-Righting Needle Holder

Up-curved, Jarit Stardust® jaws self-right curved needles; needles held very securely at any angle within the jaws.



600-266
Up-curve,
5mm, 325mm

600-267
Up-curve,
5mm, 450mm

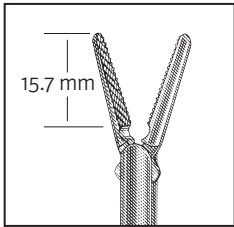

Lyons Needle Forceps

Tapered, cross-serrated jaws grasp and retract tissue for needle placement without obstructing visualization; allows the needle to be easily repositioned within the jaw for re-grasping by the needle holder at the appropriate angle; in-line handle places hand in same line as that with needle holder for more efficient suturing process, double action.

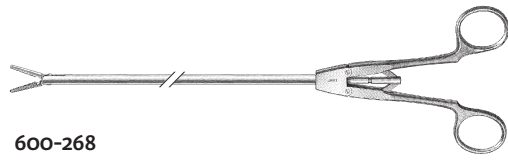

600-268
5mm, 330mm

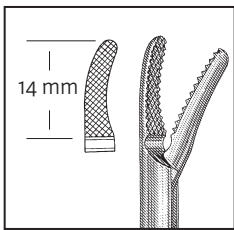

Juliet Receiving Forceps

Right curved jaws with contained hinges facilitate intracorporeal knot tying; cross-serrated jaws for tissue control during suturing.

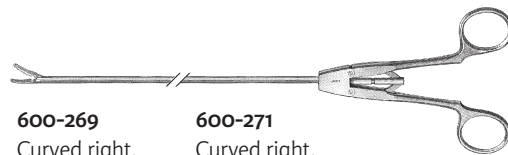

600-269
Curved right,
5mm, 330mm

600-271
Curved right,
5mm, 450mm

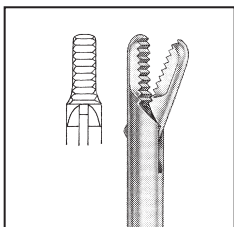

Needle Holders

Straight serrations on jaws designed to grasp straight needle securely.

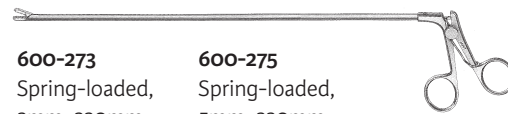

600-273
Spring-loaded,
3mm, 330mm
7mm jaw

600-275
Spring-loaded,
5mm, 330mm
9mm jaw

Suturing Set

The Integra Jarit Suturing Set offers instruments required for endoscopic suturing. The standard set, provided in a wooden case includes:

- Appel Needle Holder (600-250)
- Lyons Needle Forceps (600-268)
- Knot Pusher (600-289).

600-270

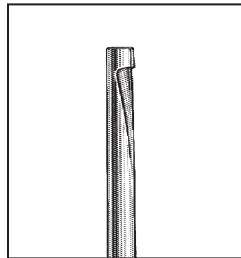
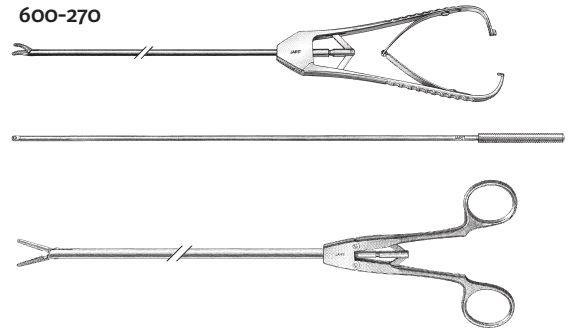

Appel Knot Pushers

Unique design facilitates the guiding of extracorporeal knots to suture site; knots can be tied and passed without repositioning the knot pusher; the twisting of suture that is experienced with standard knot pushers is minimized.

600-285
10mm,
410mm total length

600-287
5mm,
410mm total length

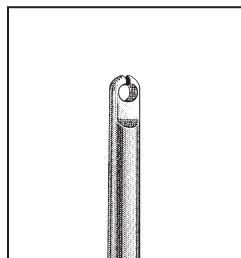

Knot Pusher

Classic design for guiding of extracorporeal knots to suture site.

600-289
4mm,
350mm total length



Endoloop Applicator

Allows placement of endoloop suture intraperitoneally.

600-240
5mm to 3mm, 175mm



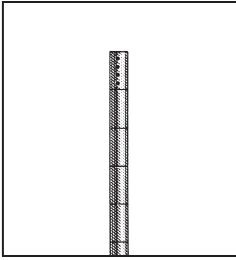

Suction/Irrigation Cannulas

Dual trumpet valves for suction and irrigation; laser guide (fiber insert) and three additional seals included.



600-320 **600-322**
5mm, 350mm 5mm, 280mm

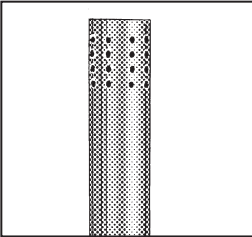

Suction/Irrigation Set

Set includes handpiece, 10mm cannula for aspiration of hematomas, gallstones, and viscous drainage, and 5mm cannula for standard suction/irrigation; suction connection straight off end minimizes clogging of cannula and sticking of valves and allows for stronger vacuum pressures; 3.5mm cannulas available.

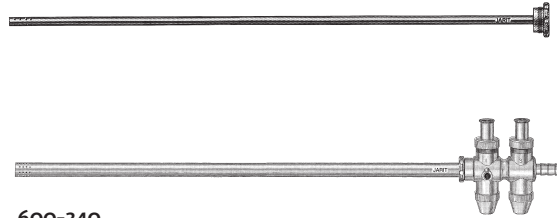

600-340
Suction/irrigation cannula
10mm, 330mm color coded
Includes 5mm and 10mm cannulas

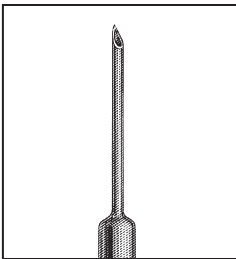

Puncture Needles with Irrigation

Large bore needle (19 Gauge to 17 Gauge) with Luer-Lok fitting for irrigation or aspiration.



600-490 **600-491**
5mm, 330mm 5mm, 450mm

Integra Jarit Articulators™ offer unique articulating instruments for retraction and dissection of veins, nerves, esophagus, and other structures. With the open/close action of the handle, the distal arm smoothly angles from 0° to 90° improving the speed and ease of articulation.

Articulators

Articulate rapidly from 0° to 90°; bi-directional Roto-Lok wheel.

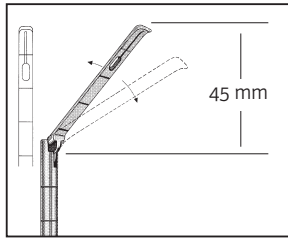

Herron Articulator Bar Retractor

Straight arm for dissection and retraction; keyhole for holding suture (e.g., anvil placement).

600-580
Roto-Lok,
locking lever,
5mm, 405mm

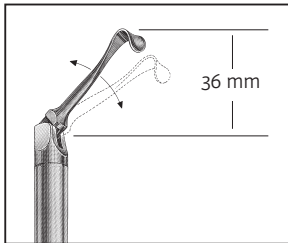

Vein/Nerve Retractor

U-shaped distal tip for atraumatic retraction of veins, nerves, etc.

600-582
Roto-Lok,
locking lever,
10mm, 365mm

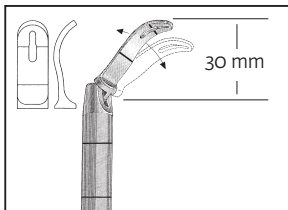

Articulator Retractor

S-shaped distal tip for atraumatic retraction of the esophagus; keyhole for maneuvering penrose drain or LAP-BAND® System.

600-584
Roto-Lok,
locking lever,
10mm, 410mm

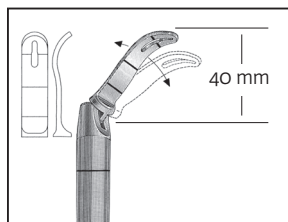

Articulator Retractor

S-shaped distal tip for atraumatic retraction of the esophagus; keyhole for maneuvering penrose drain or LAP-BAND® System.

600-585
Roto-Lok,
locking lever,
10mm, 420mm

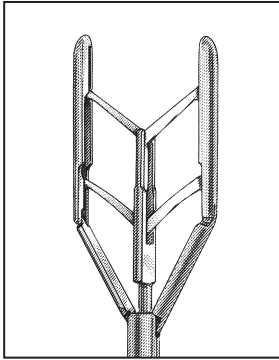

P.E.E.R.™ Retractors

Atraumatic, telescoping blades allow for elevation, retraction and mobilization of organs and tissues, while permitting optimum visualization of surgical field; fully rotatable shaft and locking mechanism combine for versatile instrument placement with stationary positioning; bar ratchet with lock secures jaws in open position; black ring at distal shaft provides identifiable mark to assure jaws have cleared cannula.

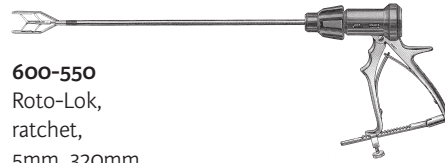

600-550
 Roto-Lok,
 ratchet,
 5mm, 320mm
 48mm retractor jaw length



600-560
 Roto-Lok,
 ratchet,
 10mm, 320mm
 68mm retractor jaw length



600-540
Fan Retractor
 Working length 380mm
 Five Finger Liver Elevator
 with up to 60° spread and
 80° Lift Functions, 10mm
 58mm fan blade length, in
 closed position.

For surgeons who prefer electrosurgical dissection, Integra Jarit has designed electrosurgical instruments to meet their specific needs. On the monopolar electrodes, the distal tip is partially insulated to assure that electricity is delivered to the tissue the surgeon has targeted. The Integra Jarit coagulator handle offers a large, comfortable surface for the surgeon's hand. The channel and trumpet valve allow quick and easy aspiration of smoke. For the surgeon who does not require smoke aspiration, cost-effective, fully insulated electrodes are available.

Bipolar instruments are designed with micro tips for effective coagulation of fine, superficial vessels, and with grasping action for electrosurgical coagulation of blood vessels.

(Note: The bipolar grasping forceps are not for use with tubal ligation.)

Suction Coagulators

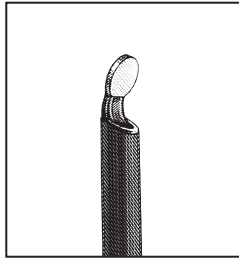

Spatula Tip Suction Coagulator

Smooth, arched, partially insulated spatula tip.

600-300
5mm, 330mm

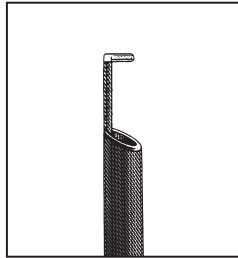

L-shaped Hook Suction Coagulator

Partially insulated right angle tip.

600-305
5mm, 330mm

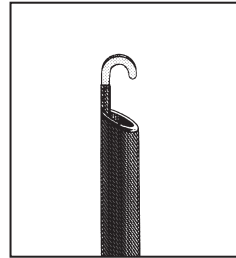

Hook End Suction Coagulator

Partially insulated hook tip.

600-310
5mm, 330mm

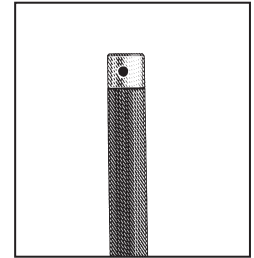

Blunt Suction Coagulator

Blunt, open-ended distal tip.

600-315
5mm, 330mm

Electrodes

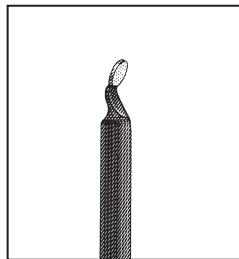

Spatula Electrodes

Smooth, arched, partially insulated spatula tip.

600-317
5mm, 330mm

600-317L
5mm, 450mm

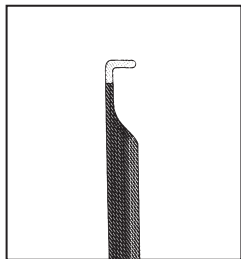

L-shaped Hook Electrodes

Partially insulated right angle tip.

600-318
5mm, 330mm

600-318L
5mm, 450mm

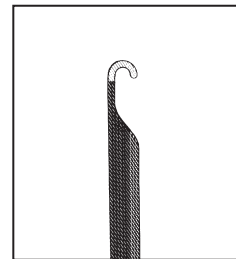

Hook Electrodes

Partially insulated hook tip.

600-319
5mm, 330mm

600-319L
5mm, 450mm

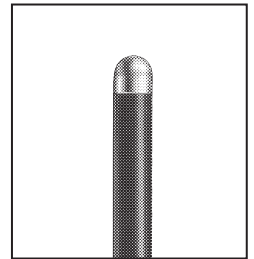

Ball Electrode

Ball tip.

600-316
5mm, 370mm

Bipolar Forceps

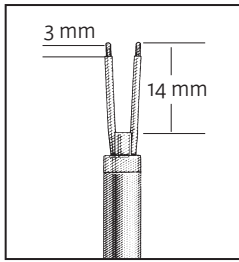

Micro Bipolar Forceps

Fine, pointed distal tip for coagulation of surface blood vessels.

615-330
5mm, 336mm

615-331
5mm, 446mm

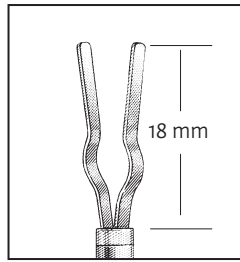
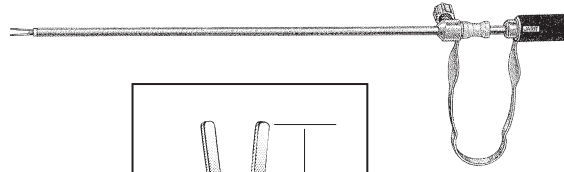

Large Bipolar Forceps

Flat 3mm wide jaws for bipolar coagulation of blood vessels.

615-334
5mm, 347mm

615-335
5mm, 457mm

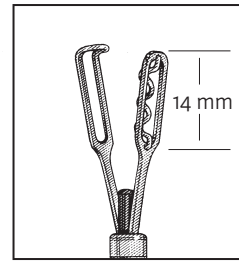

Grasping Bipolar Forceps

Wave-like jaw for bipolar coagulation of blood vessels.

615-338
5mm, 343mm

615-339
5mm, 453mm

Electrosurgical Accessories

IMPORTANT: When disconnecting electrosurgical cables from the generator or instrument, always grasp the cables by the connector only. Never pull the cable by the cord. Do not use instruments or cables if the insulation is not fully intact.



Monopolar Cable

600-290
10' (3m)



Monopolar Adapter

600-291
male to female

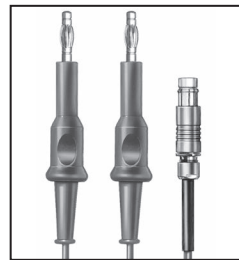

Bipolar Cable

615-295
10' (3m)



Bipolar Cable, Wolf Generator

615-296B
10' (3m)

Integra Jarit offers a diversified selection of specialized instrumentation for cholangiography, morcellation, and tissue manipulation.

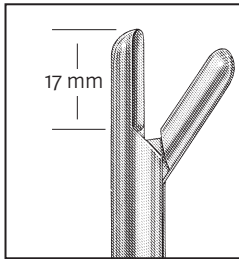

Spoon Forceps
Wide cup-shaped jaws for tissue or stone removal.



600-138
Spring-loaded, 10mm, 335mm

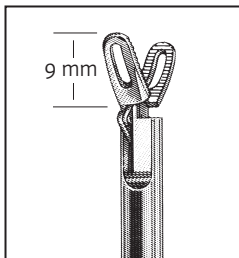

Cholangiogram Clamp
Channel for placement of 5Fr or smaller cholangiogram catheter.



600-400
Ratchet, 5mm, 330mm

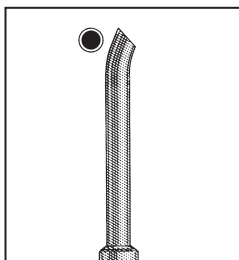

Cholangiogram Guide
Curved tip for simple placement of cholangiogram catheter.



600-410
5mm, 320mm total length



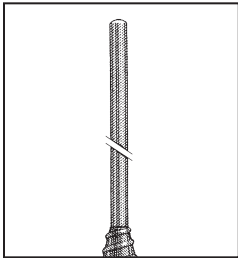

Dilation Set

For dilation of 5mm port to 10mm diameter.



600-475
5mm to 10mm

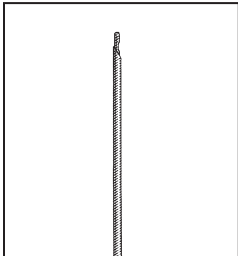

Veress Needles

Internal safety shield allows initial puncture and introduction of CO₂ for pneumoperitoneum, 14 gauge needle.



600-480 **600-481**
120mm 150mm

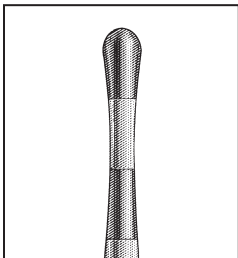

Palpation Probes

For atraumatic manipulation of tissue.



600-495 **600-496**
5mm, 300mm 5mm, 450mm

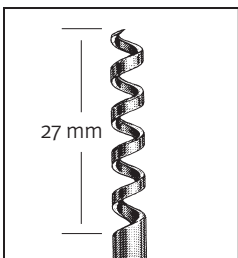

Myoma Screws

For manipulation and securing of thick-walled myoma.



615-210 **615-212**
5mm, 330mm 10mm, 330mm



Jarrit Detach[®]

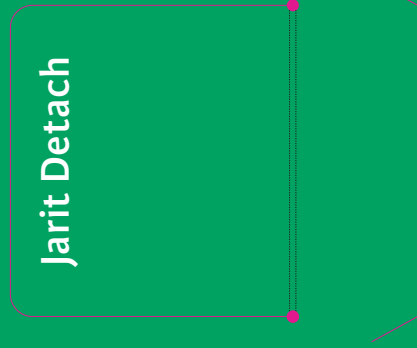

Jarrit Detach®

Jarrit Detach

Integra's two-part Jarit Detach® System easily separates into a handle/shaft component and a scissors insert. Using backup inserts, which represent only a fraction of the cost of a complete Jarit Detach instrument, substantial cost savings are achieved. Each reusable endoscopic scissors offers electro-surgical coagulation and ergonomic rotation — all in one high-quality, cost-effective instrument. For easy cleaning, a cleaning brush is included with each instrument.

Jarit Detach Scissors Insert



625-0903
Cleaning brushes, pkg/6

Jarit Detach Handle/Shaft



625-090H
Roto-Cam,
monopolar,
5mm, 307mm

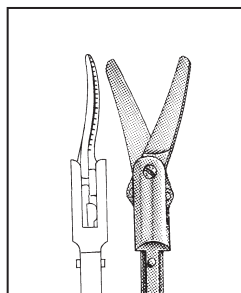

Jarit Detach Supercut Scissors
Unique Integra Jarit Supercut blade has a finely-serrated lower blade that helps prevent tissue slippage; curved blades meet the contour of structures while the blunt-shaped distal tip allows tissue manipulation and cauterization with blades closed; double action.

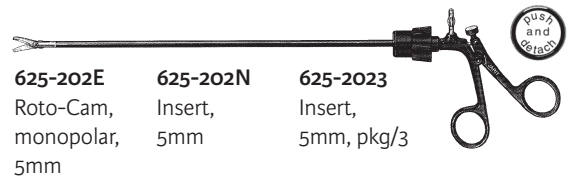

625-202E Roto-Cam, monopolar, 5mm	625-202N Insert, 5mm	625-2023 Insert, 5mm, pkg/3
---	-----------------------------------	--

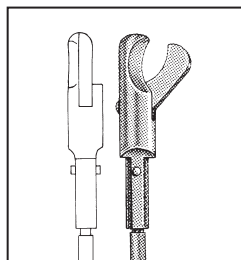

Jarit Detach Hook Scissors
Classic hook blades designed to lift, isolate and transect tissue.

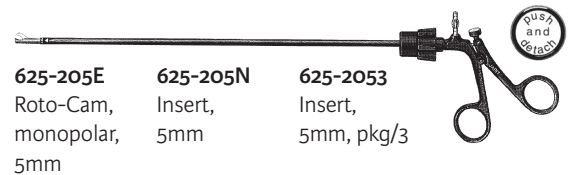

625-205E Roto-Cam, monopolar, 5mm	625-205N Insert, 5mm	625-2053 Insert, 5mm, pkg/3
---	-----------------------------------	--

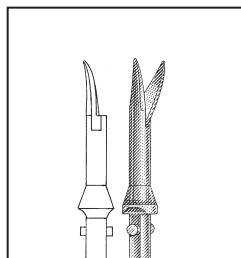

Jarit Detach Micro Scissors Curved
Delicate, sharp-sharp, curved blades

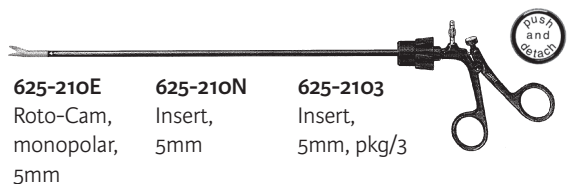

625-210E Roto-Cam, monopolar, 5mm	625-210N Insert, 5mm	625-2103 Insert, 5mm, pkg/3
---	-----------------------------------	--

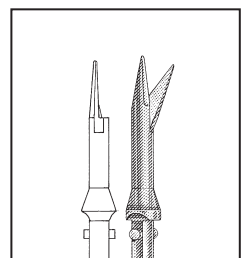

Jarit Detach Micro Scissors Straight
Delicate, sharp-sharp, straight blades

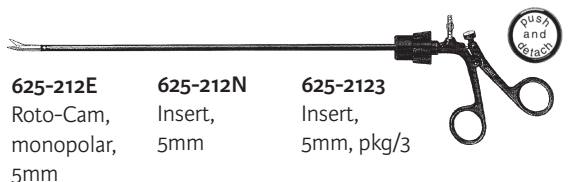

625-212E Roto-Cam, monopolar, 5mm	625-212N Insert, 5mm	625-2123 Insert, 5mm, pkg/3
---	-----------------------------------	--

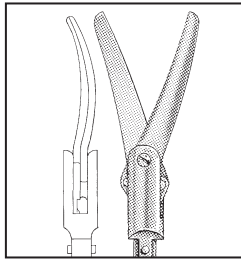

**Jarit Detach
Metzenbaum Scissors**

Long, curved, tapered blades with wide spread, double action.

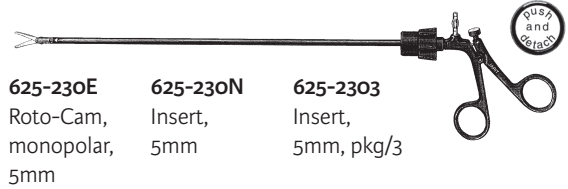

625-230E Roto-Cam, monopolar, 5mm	625-230N Insert, 5mm	625-2303 Insert, 5mm, pkg/3
---	-----------------------------------	--

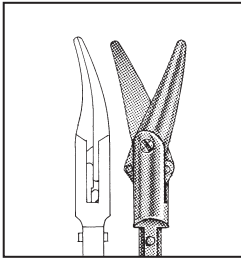

**Jarit Detach Baby
Metzenbaum Scissors**

Shorter, curved, very tapered blades reach more narrow and delicate dissection areas, double action.



625-235E Roto-Cam, monopolar, 5mm	625-235N Insert, 5mm	625-2353 Insert, 5mm, pkg/3
---	-----------------------------------	--

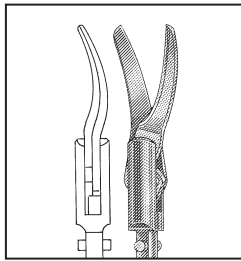

**Jarit Detach
Mini Scissors**

Curved, tapered, delicate blades, double action.



625-240E Roto-Cam, monopolar, 5mm	625-240N Insert, 5mm	625-2403 Insert, 5mm, pkg/3
---	-----------------------------------	--

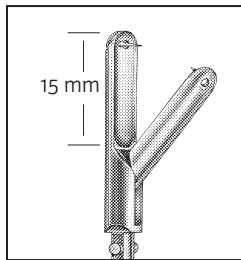

**Jarit Detach
Biopsy Forceps**

Two sharp teeth, one on each jaw, for biopsy or secure hold of thick-walled tissue

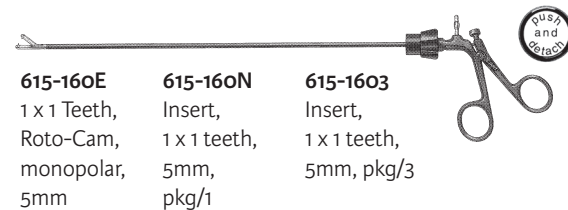

615-160E 1 x 1 Teeth, Roto-Cam, monopolar, 5mm	615-160N Insert, 1 x 1 teeth, 5mm, pkg/1	615-1603 Insert, 1 x 1 teeth, 5mm, pkg/3
---	---	--

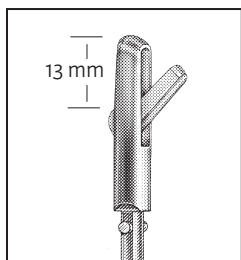

**Jarit Detach
Biopsy Punch**

Punch with serrated lower jaw.

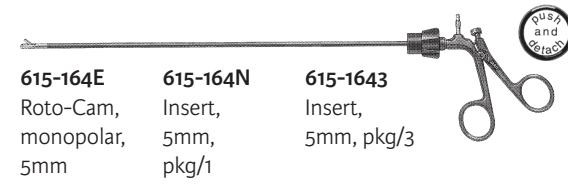

615-164E Roto-Cam, monopolar, 5mm	615-164N Insert, 5mm, pkg/1	615-1643 Insert, 5mm, pkg/3
---	---	--

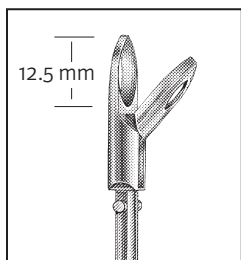

**Jarit Detach
Biopsy Forceps**

Oval-shaped fenestrated jaws.

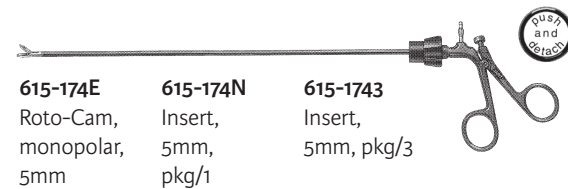

615-174E Roto-Cam, monopolar, 5mm	615-174N Insert, 5mm, pkg/1	615-1743 Insert, 5mm, pkg/3
---	---	--

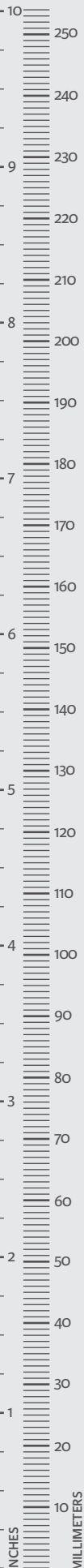

As ORs continue to look for ways to control spending, many have looked to reduce the dollars spent on disposable cannula systems. This demand is met by Integra Jarit's reusable auto-valve cannulas which also allow for the convenience of hands-free operation. The built-in fascial threads prevent the cannula from slipping, and the lightweight construction makes it easier to insert instruments.

Auto-Valve Cannulas and Trocars, Non-threaded

Hands-free flapper valve; color-coded seals with size and color reference stamped on cannula; arrow on cannula indicates location of valve opening; stopcock for insufflation tubing; pyramidal trocar.

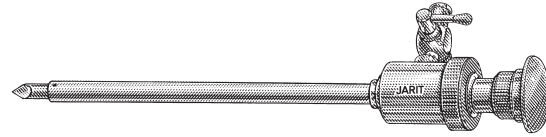

600-423

10/11mm, 101mm

600-428

5mm, 104mm

600-444

12mm, 98mm

Auto-Valve Cannulas and Trocars, Threaded

Fascial threads minimize in/out movement of cannula; hands-free flapper valve; color-coded seals with size and color reference stamped on cannula; arrow on cannula indicates location of valve opening; stopcock for insufflation tubing; pyramidal trocar.

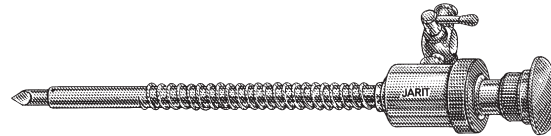

600-424

10/11mm, 106mm

600-426

5mm, 107.5mm

Trocars

Pyramidal trocar available separately for backup.



600-425

Auto-Valve,
11mm

600-431

Piston-Valve,
5mm

600-427

Auto-Valve,
5mm

600-441

Piston-Valve,
11mm

600-447

Auto-Valve,
12mm

Auto-Valve Hasson Cannulas

For open technique of cannula placement; Auto-valve allows hands-free insertion and removal of instruments; with suture ties on cone, cannula can be repositioned without retying suture; blunt obturator.

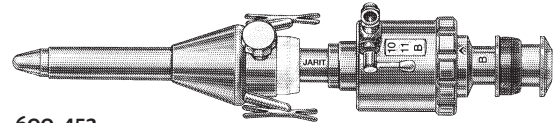

600-452
10/11mm, 101mm

630-452
5mm, 105mm

S-Retractors (set of 2)

For retraction of tissue during open technique placement of Hasson cannula.

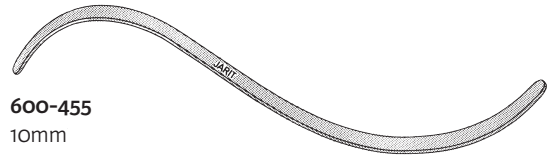

600-455
10mm

Thoracic Cannula, Threaded

Fascial threads minimize in/out movement of cannula; blunt obturator.

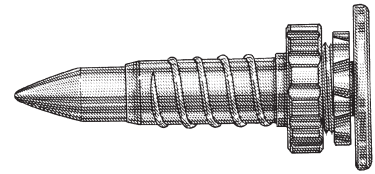

600-448
12mm

Reducer Sleeves

Reduces piston valve cannulas and facilitates extraction of tissue.

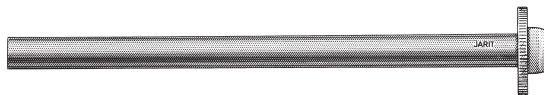

600-460
10/11mm to 5mm

600-468
12mm to 5mm

600-465
5mm to 3mm

600-469
12mm to 10mm

600-461
Reducer "Flip Top"
for auto-valve
12.5/11/10mm to 5.5mm

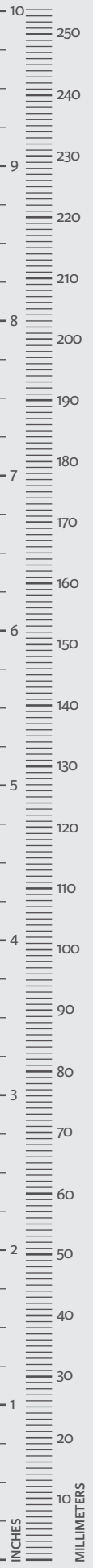
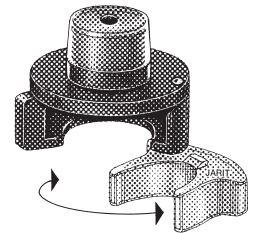

Accessories

Accessories

Accessories

Accessories

Laparoscopic Case**600-618**

Length 57.9 cm

22-3/4" x 11" x 8"

(579mm x 282mm x 203mm)

Laparoscopic Bariatric Case**600-620**

Length 68.1 cm

26-3/4" x 11" x 8"

(681mm x 282mm x 203mm)

**Instrument Holder**

The articulated Integra Jarit Endoscope & Instrument Holder System is a robust and simple system that will provide added stability and precision to the OR setting. The Integra Jarit Endoscopic & Instrument Holder System can be used with instruments with 5mm or 10mm diameter.

620-800 Endoscope & Instrument Holder

Complete set includes the following components:

- Articulated arm with Endoscope & Instrument Clamp
5/10mm (one piece), 85cm total length
- Rail Clamping Base, double clamp (**620-804**)

620-805 Bariatric Endoscope & Instrument Holder

Complete set includes the following components:

- Articulated arm with Endoscope & Instrument Clamp
5/10mm (one piece), 100cm total length
- Rail Clamping Base, double clamp (**620-804**)



Precision engineering with a rod lens optical system allows these high-quality scopes to deliver exceptional brilliance and clarity. Each scope transmits crisp, clear images with more natural color and enhanced contrast.

Autoclavable Laparoscopes

Gravity and prevacuum steam autoclavable; panoramic view with high-quality optics.

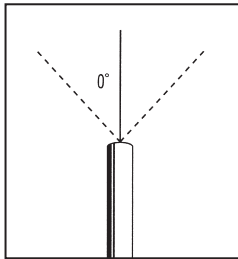

600-700
10mm, 0°
323mm

600-750
5mm, 0°
306mm

630-700
2.7mm, 0°
175mm

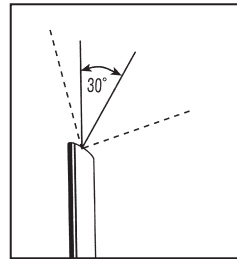

600-730
10mm, 30°
325mm

600-780
5mm, 30°
306mm

630-730
2.7mm, 30°
175mm

Operating Laparoscopes

Offset laparoscope with instrument channel which accommodates 5mm, 45cm instruments or laser; high-quality optics with panoramic view.

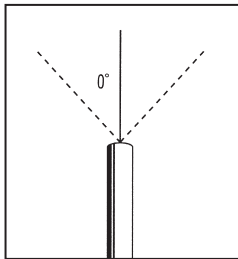

615-700
Autoclavable,
10mm, 0°

615-700

Light Post Adapters

- 600-292** Laparoscope Light Post, Storz
- 600-293** Laparoscope Light Post, Wolf
- 600-294** Laparoscope Light Post, Olympus

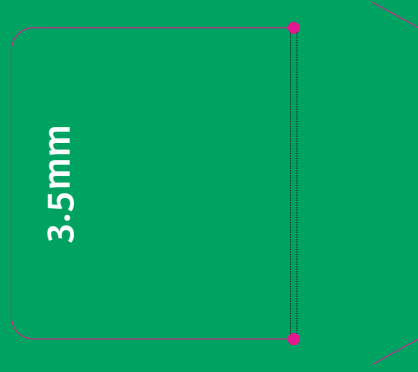

3.5mm

3.5mm

3.5mm

Roto-Lok, ratchet, insulated shaft

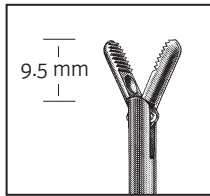
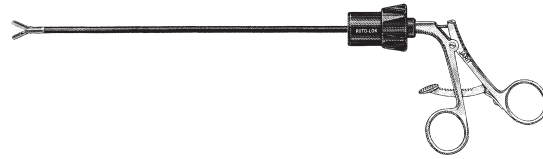

Grasping Forceps

630-100
3.5mm, 240mm

632-100
3.5mm, 320mm

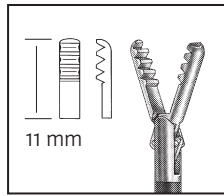

Grabber Forceps

630-104
3.5mm, 240mm

632-104
3.5mm, 320mm

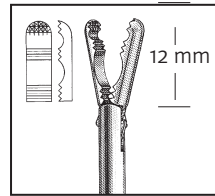

Dual-cup Grasping Forceps

630-108
3.5mm, 240mm

632-108
3.5mm, 320mm

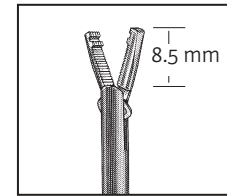

Atrau-Allis Grasping Forceps

630-113
3.5mm, 240mm

632-113
3.5mm, 320mm

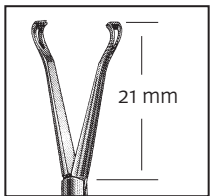

Babcock Forceps

For atraumatic, yet secure grasp of delicate tissue.

630-147
3.5mm, 240mm

632-147
3.5mm, 320mm

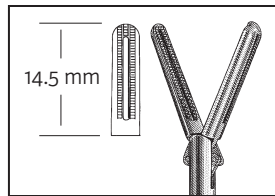

Hunter Bowel Grasper

Fenestrated, 14mm jaws for atraumatic grasping.

630-164
Non-ratcheted,
3.5mm, 240mm

632-164
Non-ratcheted,
3.5mm, 320mm

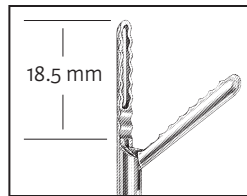

Fundus Grasping Forceps

Beveled-edge jaws.

630-107
3.5mm, 240mm

632-107
3.5mm, 320mm

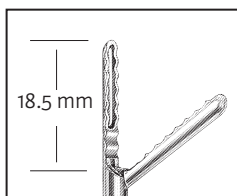

Fundus Grasping Forceps

630-107IL
Ratchet,
3.5mm, 240mm

632-107IL
Ratchet,
3.5mm, 320mm

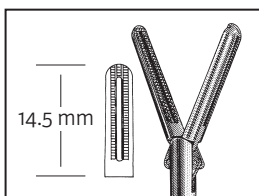

Hunter Bowel Grasper

630-164IL
Non-ratcheted,
3.5mm, 240mm

632-164IL
Non-ratcheted,
3.5mm, 320mm



In-Line,
insulated shaft

Roto-Cam, monopolar

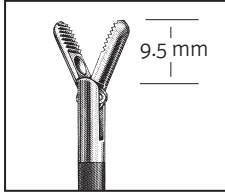

Grasping Forceps
630-105
Monopolar,
3.5mm, 240mm

632-105
Monopolar,
3.5mm, 320mm

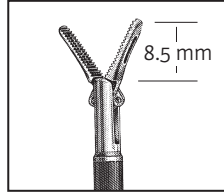

Micro Dissecting Forceps
630-110
Monopolar,
3.5mm, 240mm

632-110
Monopolar,
3.5mm, 320mm

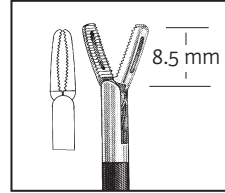

Strong Forceps
630-111
Monopolar,
3.5mm, 240mm

632-111
Monopolar,
3.5mm, 320mm

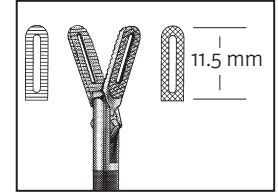

Pyloromyotomy Dissector
630-116
Monopolar,
3.5mm, 140mm

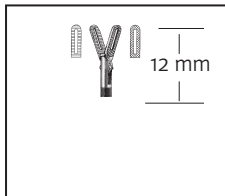

Maryland Dissectors
630-126
Monopolar,
3.5mm, 240mm

632-126
Monopolar,
3.5mm, 320mm

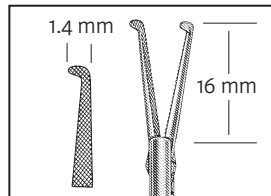

Mixer Spreader-Dissectors
630-129RH
Monopolar, ring-handle,
3.5mm, 240mm

632-129RH
Monopolar, ring-handle,
3.5mm, 320mm

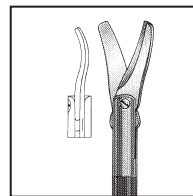

Endo Supercut Scissors, Curved
630-202
Monopolar,
3.5mm, 240mm

632-202
Monopolar,
3.5mm, 320mm

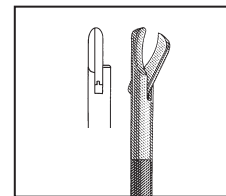

Hook Endo Scissors
630-205
Monopolar,
3.0mm, 240mm

632-205
Monopolar,
3.0mm, 320mm

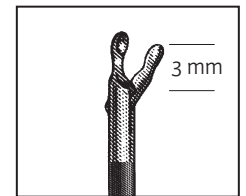

Biopsy Forceps
630-178
Monopolar,
3.5mm, 240mm

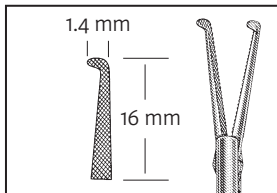

Mixer Spreader-Dissectors

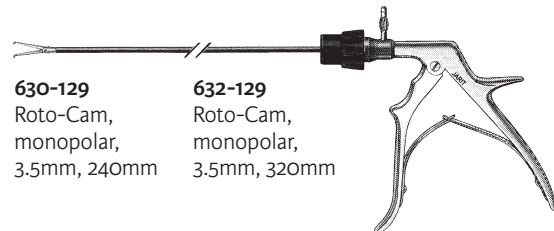

630-129
Roto-Cam,
monopolar,
3.5mm, 240mm

632-129
Roto-Cam,
monopolar,
3.5mm, 320mm

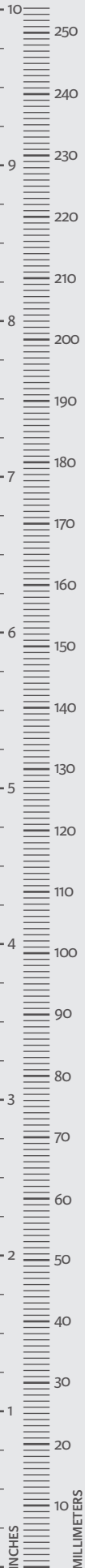

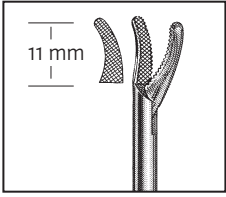

Appel Needle Holders
For use with 5-0 suture and smaller.

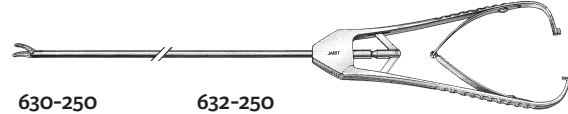

630-250 Left Curve, 3.5mm, 240mm	632-250 Left Curve, 3.5mm, 320mm
---	---

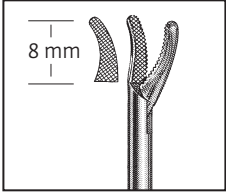

In-line Carb-Bite Needle Holder

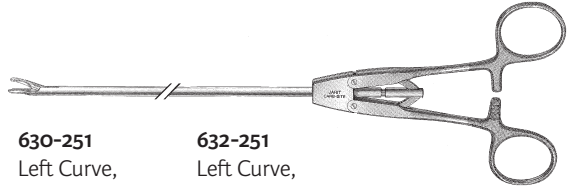

630-251 Left Curve, 3.5mm, 240mm	632-251 Left Curve, 3.5mm, 330mm
---	---

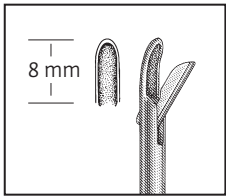

Romeo Self-Righting Needle Holder



630-266 3.5mm, 241mm	632-266 3.5mm, 325mm
--------------------------------	--------------------------------

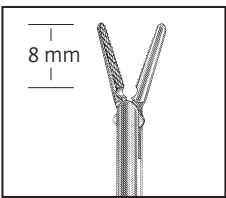

Lyons Needle Forceps

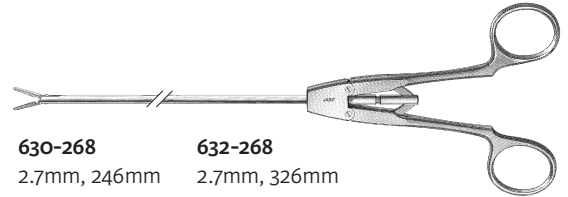

630-268 2.7mm, 246mm	632-268 2.7mm, 326mm
--------------------------------	--------------------------------

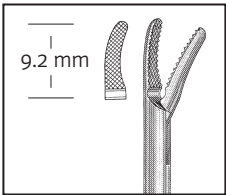

Juliet Receiving Forceps

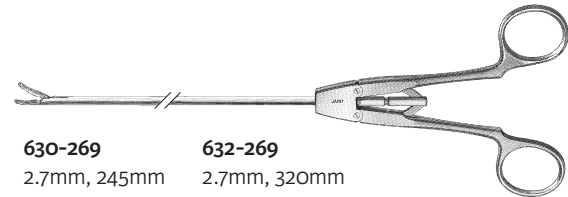

630-269 2.7mm, 245mm	632-269 2.7mm, 320mm
--------------------------------	--------------------------------

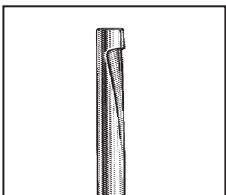

Appel Knot Pusher



630-287
2.7mm, 340mm overall length

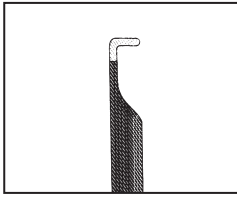

L-shaped Hook Electrodes

Partially insulated,
right angle tip.



630-318
3.5mm, 243mm

632-318
3.5mm, 330mm

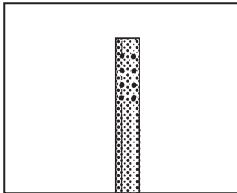

Suction/Irrigation Cannula



630-340
3.5mm, 240mm

Auto-Valve Cannula and Trocar

Auto-valve cannula and pyramidal trocar 3.5mm with
silicone valve and luer-lock for insufflation tubing

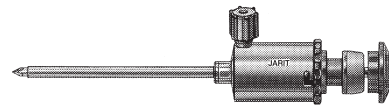

630-427
Auto-valve cannula and pyramidal trocar
3.5mm



630-429
Pyramidal trocar for
auto-valve 3.5mm



630-4300
Blunt trocar for
auto-valve 3.5mm

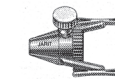

630-4512
Nose Cone with wings,
for auto-valve cannula
3.5mm

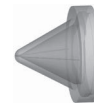

630-4350
Silicone valve for auto-
valve cannula 3.5mm,
drop-shaped (package of 5)
for single use only!

Reducer Sleeve

Reduces piston valve cannulas and facilitates
extraction of tissue.

600-465
5mm to 3mm

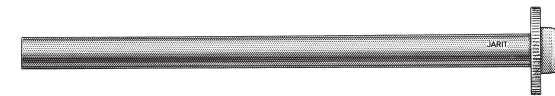

Autoclavable Laparoscope

Panoramic view with high-quality optics.

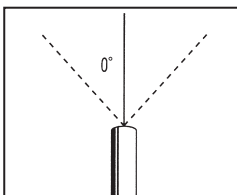

630-700
2.7mm, 0°, 175mm

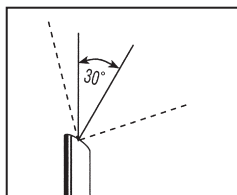

630-730
2.7mm, 30°, 175mm

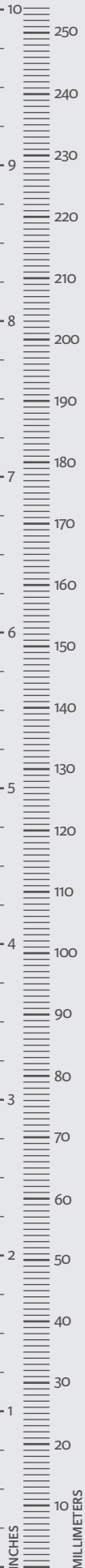
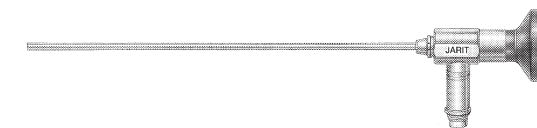

Catalog #	Description
600-300/305/310/315	Suction Coagulators
600-TVA	T-V Replacement Parts Kit
600-3003	T-V Guide Pin, Pkg/6 (Tappet/Cap/Valve)
600-3004	T-V Spring, Pkg/6
600-3005	Trumpet Valve Case
600-3006	T-V Bottom Cap, Pkg/6
600-3007	T-V Set Screw, Pkg/12
600-320/322	Suction/Irrigation Cannulas
600-3010	Rubber Cap W/O Hole, Pkg/12 (Suction Cannulas)
600-3021	Trumpet Valve (320/322), Pkg/6
600-3022	Trumpet Valve Top Cap (320/322), Pkg/6
600-3023	Trumpet Valve Pin Cap (320/322), Pkg/6
600-3027	Trumpet Valve Set Screw (320/322), Pkg/6
600-3029	Metal Base Cap (320/322), Pkg/12
600-CTVA	Replacement Parts Kit (Includes 600-3024, 3033 And 3036)
600-3024	T-V Spring (320/322), Pkg/6
600-3033	Ctv Assembly (320/322), Pkg/3
600-3036	Ctv Bottom Cap (320/322), Pkg/6
X600-320LASER	Laser Channel Only For 600-320
X600-322LASER	Laser Channel Only For 600-322
600-330	Suction/Irrigation Set, 10mm, 33cm **Discontinued
630-330	Suction/Irrigation Cannula, 3.5mm **Discontinued
600-3301	Irrigation Valve (330)
600-3302	Suction Valve (330)
600-3303	Valve Top Cap (330), Pkg/6
600-3304	Valve Spring (330/340), Pkg/6
600-3305	Valve Bottom Cap (330), Pkg/6
600-3306	Replacement Cannula 5mm (600-330/600-340)
600-3307	Replacement Cannula 10mm (600-330/600-340)
630-3308	Replacement Cannula 3.5mm (630-330)
600-330HOUS	Main Housing For (330)
600-3309	O-Ring (330/340), Pkg/6
600-340	Suction/Irrigation Set, 10mm
630-340	Suction/Irrigation Cannula, 3.5mm
600-3401	Irrigation Valve (340) Blue
600-3402	Suction Valve (340) Green
600-3304	Valve Spring (330/340), Pkg/6
600-3405	Valve Bottom Cap (340), Pkg/6
600-3306	Replacement Cannula 5mm 600-330/600-340
600-3307	Replacement Cannula 10mm 600-330/600-340
600-340HOUS	Main Housing For (340)
600-3309	O-Ring (330/340), Pkg/6
630-3308	Replacement Cannula 3.5mm 240mm
632-3308	Replacement Cannula 3.5mm 340mm
600-423	Auto-Valve Cannula and Trocar, Non-threaded, 10/11mm
600-424	Auto-Valve Cannula and Trocar, Threaded, 10/11mm
600-4240	Inner Seal (Yellow) (423/424/444/452), Pkg/6
600-4241	Knurled Ring (423/424/444/452), Pkg/6
600-4242	O-Ring (423/424/444/452), Pkg/6
600-4420	Outer Seal (Blue) (423/424/440/450/452/471), Pkg/6
600-4503	Stopcock Cap (All Trocars/Cannulas), Pkg/6



Catalog #	Description
600-426	Auto-Valve Cannula and Trocar, Non-threaded, 5mm
600-428	Auto-Valve Cannula and Trocar, Threaded, 5mm
600-4260	Inner Seal (Tan) (426/428), Pkg/6
600-4261	Knurled Ring (426/428), Pkg/6
600-4262	O-Ring (426/428), Pkg/6
600-4320	Outer Seal (Red) (426/428/430/462/470), Pkg/6
600-4503	Stopcock Cap (All Trocars/Cannulas), Pkg/6
600-444	Auto-Valve Cannulas and Trocars, Non-threaded, 12mm
600-4240	Inner Seal (Yellow) (423/424/444/452), Pkg/6
600-4241	Knurled Ring (423/424/444/452), Pkg/6
600-4242	O-Ring (423/424/444/452), Pkg/6
600-4470	Outer Seal (Green) (444/445), Pkg/6
600-4503	Stopcock Cap (All Trocars/Cannulas), Pkg/6
600-430	Cannula & Trocar Pyramid Tip 5mm **Discontinued
600-3030	Valve Spring (430), Pkg/6
600-3031	K-Cap W/Hole (430), Pkg/6
600-3032	K-Cap W/O Hole (430), Pkg/6
600-4320	Outer Seal (Red) (426/428/430/462/470), Pkg/6
600-4503	Stopcock Cap (All Trocars/Cannulas), Pkg/6
600-440	Cannula & Trocar Pyramid Tip 10/11mm **Discontinued
600-3040	Valve Spring (440/450), Pkg/6
600-3041	K-Cap W/Hole (440/450), Pkg/6
600-3042	K-Cap W/O Hole (440/450), Pkg/6
600-4420	Outer Seal (Blue) (423/424/440/450/452/471), Pkg/6
600-4503	Stopcock Cap (All Trocars/Cannulas), Pkg/6
600-445	Cannula & Trocar Pyramid Tip 12mm **Discontinued
600-3050	Valve Spring (445), Pkg/6
600-3051	K-Cap W/Hole (445), Pkg/6
600-3052	K-Cap W/O Hole (445), Pkg/6
600-4470	Outer Seal (Green) (444/445), Pkg/6
600-4503	Stopcock Cap (All Trocars/Cannulas), Pkg/6
600-448	Thoracic Cannula Threaded 12mm
600-4481	Stabilizing Cylinder (448), Pkg/2
600-450	Hasson Cannula 10/11mm, Blunt **Discontinued
600-3040	Valve Spring (440/450), Pkg/6
600-3041	K-Cap W/Hole (440/450), Pkg/6
600-3042	K-Cap W/O Hole (440/450), Pkg/6
600-4420	Outer Seal (Blue) (423/424/440/450/452/471), Pkg/6
600-4501	Blunt Trocar (450/452)
600-4502	Nose Cone (450/452)
600-4503	Stopcock Cap (All Trocars/Cannulas), Pkg/6
600-4504	Suture Attachment (450/452)
600-4520	Cone Seal (450/452), Pkg/6

Catalog #	Description
600-452	Auto-Valve Hasson Cannula, 10/11mm
600-4240	Inner Seal (Yellow) (423/424/444/452), Pkg/6
600-4241	Knurled Ring (423/424/444/452), Pkg/6
600-4242	O-Ring (423/424/444/452), Pkg/6
600-4420	Outer Seal (Blue) (423/424/440/450/452/471), Pkg/6
600-4501	Blunt Trocar (450/452)
600-4502	Nose Cone (450/452)
600-4503	Stopcock Cap (All Trocars/Cannulas), Pkg/6
600-4520	Cone Seal (450/452), Pkg/6
630-452	Auto-Valve Hasson Cannula, 5mm
600-4260	Replace Inner Seal(426/428), Pkg/6
600-4261	Knurled Ring (426/428), Pkg/6
600-4262	O-Ring (426/428), Pkg/6
600-4320	Outer Seal (Red) (426/428/430/462/470), Pkg/6
600-4503	Stopcock Cap (All Trocars/Cannulas), Pkg/6
630-4501	Blunt Trocar (452)
630-4502	Nose Cone (452)
630-4520	Cone Seal (452), Pkg/6
630-427	Auto-Valve Cannula and Trocar, 3.5mm
630-4300	Blunt Trocar
630-4320	Outer Seal (Red), Pkg/6
630-4350	Silicone Valve For Auto-Valve, Pkg/5
600-240	Endoloop Applicator
600-460/465/468/469	Reducer Sleeves
600-4620	Replacement Seal (460), Pkg/6
600-4670	Replacement Seal Diam. 2mm (240/465), Pkg/6
600-4680	Replacement Seal (468), Pkg/6
600-4690	Replacement Seal (469), Pkg/6
600-461	Reducer Flip-Top
600-4320	Outer Seal (Red) (426/428/430/462/470), Pkg/6

Catalog #	Description
600-550/560 600-SPS-550	P.E.E.R. Retractors Spring And Screw (550/560)
600-580/582/584/585 X600-580CPCAP	Articulators Plastic Cap For Cleaning Port
615-330/334/338 615-331/335/339 615-334HC 615-EC-330	Bipolar Forceps 32cm Bipolar Forceps 45cm Plastic Brushing For Bipolar Connector (White), Pkg/3 End Caps For Bipolars, Pkg/3
600-410 600-3011	Cholangiogram Guide Rubber Cap W/Hole, Pkg/12 (410)
600-700/730/750/780 615-700 630-700/730 615-3011	5/10mm Laparoscopes 10mm Offset Laparoscope 2.7mm Laparoscopes Rubber Cap For Light Cable Connectors, Pkg/6
600-130/135/137/138/273/275 615-160/162/178 600-SCR-138 600-3017 X600-135SPRING	Spring-Loaded Instruments Screw Only For Spring-Loaded Handles Spring And Screw For Spring-Loaded Handles, Pkg/6 Spring Only For Spring-Loaded Handles
620-800/805 620-804 620-EC-800 620-WHS-800	Endoscope and Instrument Holders Rails Clamping Base, Double Clamp End Screw (800/805) Wing Handle Screw (800/805)











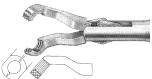
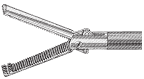

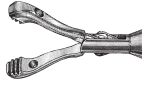
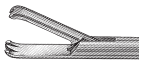
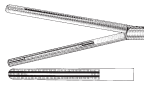

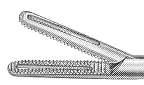
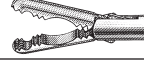

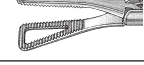

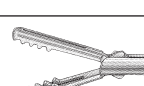

Index

Index

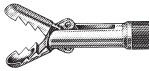
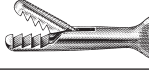
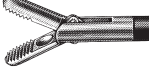
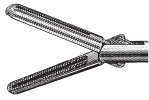
Index

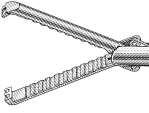
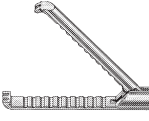
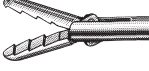
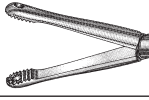
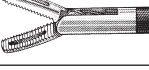

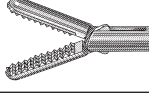
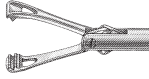



Tip Style	Dia	One-Piece		
		SKU's	Page	
Graspers				
	Allis Grasping Forceps	5mm	600-122 625-122	7
	Anvil Grasping Forceps	10mm	625-154	12
	Atrau-Allis Grasping Forceps	5mm	600-113, 600-114 625-113, 625-113LL	7
	Atrau-Allis Long Jaw Grasping Forceps	5mm	625-114 625-114LL	7
	Babcock Forceps, 5mm	5mm	600-147, 610-147 625-147, 625-147LL	11
	Babcock Forceps, 10mm	10mm	625-144	10
	Babcock Forceps, Round Jaw	10mm	600-145 625-145	11
	Claw Forceps	5mm	600-137	9
	Claw Forceps	10mm	600-135	9
	DeBakey Forceps	5mm	600-140, 610-140 610-140L, 625-140LL	9
	DeBakey Forceps, Curved	10mm	625-141	9
	DJB Grasping Forceps	5mm	625-139 625-139LL	9
	Dual-Cup Grasping Forceps	5mm	600-108IL, 610-108 625-108, 625-108LL	6
	Duckbill Grasping Forceps	5mm	625-118	12
	Duval Grasping Forceps	10mm	600-150 625-150	12
	Foerster Sponge Forceps	10mm	600-158	13
	Fundus Grasping Forceps - Double Action	5mm	600-107IL, 610-107DA 625-107D5, 625-107DA 625-107RD	6
	Fundus Grasping Forceps - Single Action	5mm	610-107, 625-107 625-107LL	6
	Grabber Forceps	5mm	600-104IL, 610-104 625-104, 625-104LL 625-106LL	5



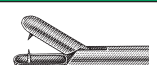

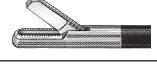
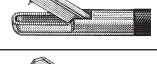



Tip Style		Dia	One-Piece	
			SKU's	Page
Graspers				
	Grasping and Dissecting Forceps	5mm	600-120	8
	Grasping and Extracting Forceps	10mm	600-130	8
	Grasping Forceps	5mm	600-100, 600-105 600-106, 605-100 610-100, 625-100 625-100LL, 625-105	4
	Hunter Bowel Grasper	5mm	600-164L, 610-163 610-164, 610-165 625-163, 625-164 625-164LL, 625-165LL	13
	Paddle Babcock Forceps	5mm	600-143L, 625-143 625-143LL, 625-146LL	10
	Paddle Babcock Forceps	10mm	625-142	10
	Retraction Grasping Forceps - Double Action	5mm	625-109DA, 625-109IL 652-109RD	7
	Retraction Grasping Forceps - Single Action	5mm	625-109 625-109LL	7
	Retrograde Grasping Forceps	5mm	600-116, 600-118 600-119	8
	Russian Grasping Forceps	10mm	600-154	12
	Strong Forceps	5mm	615-109, 615-110 615-111	14
	Strong Hold Babcock Forceps	5mm	610-149	10
	Strong TC Grasping Forceps	5mm	625-101, 625-103 625-103LL	5
	Swanstrom Grasping Forceps	5mm	600-148IL, 610-148 625-148, 625-148LL	11
	TC Grasping Forceps	5mm	625-102 625-102LL	4
	Tenaculum Forceps	5mm	605-152	14
	Tenaculum Forceps	10mm	615-150 615-152	14

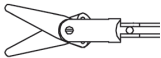
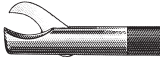

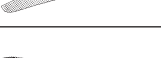
Tip Style		Dia	One-Piece	
			SKU's	Page
Dissectors				
	Bullet-Nose Dissecting Forceps	5mm	625-117	17
	Maryland Dissector - Long Jaw	10mm	625-125	17
	Maryland Dissector - Standard	5mm	600-126, 625-126 625-127	17
	Maryland Dissector - Standard	10mm	600-125	17
	Micro Dissecting Forceps	5mm	600-110 625-110	16
	Micro Grasping Forceps	5mm	600-117	16
	Mixer Dissecting Forceps	10mm	600-127	18
	Mixer Spreader-Dissector	5mm	625-129, 625-129RH 625-130RH	18
	Mixer Spreader-Dissector	10mm	600-128, 625-128 625-128RH	18
	Needle Nose Forceps	5mm	600-112 625-112	16
	Right Angle Dissector	10mm	625-132	18
	Tapered Dissecting Forceps	5mm	600-115 625-115	16
	Tapered Maryland Dissector	5mm	625-124	17

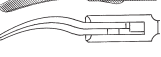
Tip Style		Dia	One-Piece	
			SKU's	Page
Biopsy Forceps				
	Biopsy Forceps, 2 Teeth	5mm	615-160 615-162	19
	Biopsy Forceps, Oval Fenestrated	5mm	615-174 615-176	19
	Biopsy Punch	5mm	615-164 615-166	19
	Biopsy Punch, 1 Tooth	5mm	615-170 615-172	19
	Hook Biopsy Punch	5mm	615-168 615-169	19
	Micro Biopsy Forceps	5mm	615-178	19
	Spoon Forceps	10mm	600-138	30

Tip Style		Dia	One-Piece	
			SKU's	Page
Scissors				
	Baby Metzenbaum	5mm	-	-
	Hook Scissors	5mm	600-205 600-206 600-207 625-205	20
	Mayo Operating Scissors	10mm	600-220	21
	Metzenbaum Scissors	5mm	625-230	21
	Micro Scissors, Curved Left	5mm	600-212	21
	Micro Scissors, Straight	5mm	600-210	21
	Mini Scissors	5mm	625-240	21
	Supercut Endo Scissors, Curved	5mm	600-202 600-203	20
	Supercut Endo Scissors, Straight	5mm	625-201	20
	Supercut Scissors	5mm	600-200 600-201	20

600-100	4, 49	600-3003	43	600-4470	44	615-1603	34	625-127	17, 50
600-104IL	5, 48	600-3004	43	600-448	44, 45	615-160E	34	625-128	18, 50
600-105	4, 49	600-3005	43	600-4481	44	615-160N	34	625-128RH	18, 50
600-106	4, 49	600-3006	43	600-450	44	615-162	19, 46, 50	625-129	18, 50
600-107IL	6, 48	600-3007	43	600-4501	44, 45	615-164	19, 50	625-129RH	18, 50
600-108IL	6, 48	600-3010	43	600-4502	44, 45	615-1643	34	625-130RH	18, 50
600-109IL	7	600-3011	46	600-4503	44, 45	615-164E	34	625-132	18, 50
600-110	16, 50	600-3017	46	600-4504	44	615-164N	34	625-139	9, 48
600-112	16, 50	600-3021	43	600-452	36, 45	615-166	19, 50	625-139LL	9, 48
600-113	7, 48	600-3022	43	600-4520	44, 45	615-168	19, 50	625-140LL	9, 48
600-114	7, 48	600-3023	43	600-455	36	615-169	19, 50	625-141	9, 48
600-115	16, 50	600-3024	43	600-460	36, 45	615-170	19, 50	625-142	10, 49
600-116	8, 49	600-3027	43	600-461	36, 45	615-172	19, 50	625-143	10, 49
600-117	16, 50	600-3029	43	600-4620	45	615-174	19, 50	625-143LL	10, 49
600-118	8, 49	600-3030	44	600-465	36, 42, 45	615-1743	34	625-144	10, 48
600-119	8, 49	600-3031	44	600-4670	45	615-174E	34	625-145	11, 48
600-120	8, 49	600-3032	44	600-468	36, 45	615-174N	34	625-146LL	10, 49
600-122	7, 48	600-3033	45	600-4680	45	615-176	19, 50	625-147	11, 48
600-123	8	600-3036	43	600-469	36, 45	615-178	19, 50	625-147LL	11, 48
600-125	17, 50	600-3040	44	600-4690	45	615-210	31	625-148	11, 49
600-126	17, 50	600-3041	44	600-475	31	615-212	31	625-148LL	11, 49
600-127	18, 50	600-3042	44	600-480	31	615-295	29	625-150	12, 48
600-128	18, 50	600-305	28, 43	600-481	31	615-296B	29	625-154	12, 48
600-130	8, 46, 49	600-3050	44	600-490	25	615-3011	46	625-163	13, 49
600-135	9, 48	600-3051	44	600-491	25	615-330	29, 46	625-164	13, 49
600-137	9, 48	600-3052	44	600-495	31	615-331	29, 46	625-164LL	13, 49
600-138	30, 50	600-310	28, 43	600-496	31	615-334	29, 46	625-165LL	13, 49
600-140	9, 48	600-315	28, 43	600-500	18	615-334HC	46	625-200	20
600-143IL	10, 49	600-316	28	600-520	14	615-335	29, 46	625-201	20, 51
600-145	11, 48	600-317	28	600-522	14	615-338	29, 46	625-202	20
600-147	11, 48	600-317L	28	600-540	27	615-339	29, 46	625-2023	33
600-148IL	11, 49	600-318	28	600-550	27, 46	615-700	35, 46	625-202E	33
600-150	12, 48	600-318L	28	600-560	27, 46	615-EC-330	46	625-202N	33
600-154	12, 49	600-319	28	600-580	26, 46	620-800	37, 46	625-203	20
600-158	13, 48	600-319L	28	600-582	26, 46	620-804	37, 46	625-205	20, 51
600-160	13	600-320	25, 43	600-584	26, 46	620-805	34, 46	625-2053	33
600-164IL	13, 49	600-322	25, 40	600-585	26, 46	620-EC-800	46	625-205E	33
600-200	20, 51	600-330	43	600-618	37	620-WHS-800	46	625-205N	33
600-201	20, 51	600-3301	43	600-620	37	625-0903	33	625-2103	33
600-202	20, 51	600-3302	43	600-700	38, 46	625-090H	33	625-210E	33
600-203	20, 51	600-3303	43	600-730	38, 46	625-100	4, 49	625-210N	33
600-205	20, 51	600-3304	43	600-750	38, 46	625-100LL	4, 49	625-2123	33
600-206	20, 51	600-3305	43	600-780	38, 46	625-101	5, 49	625-212E	33
600-207	20, 51	600-3306	43	600-CTVA	43	625-102	4, 49	625-212N	33
600-210	21, 51	600-3307	43	600-SCR-138	46	625-102LL	4, 49	625-230	21, 51
600-212	21, 51	600-3309	43	600-SPS-550	46	625-103	5, 49	625-2303	34
600-220	21, 51	600-330HOUS	43	600-TVA	43	625-103LL	5, 49	625-230E	34
600-240	24, 45	600-340	25, 43	605-100	4, 49	625-104	5, 48	625-230N	34
600-249	22	600-340HOUS	43	605-152	14, 49	625-104LL	5, 48	625-2353	34
600-250	22, 24	600-3401	43	610-100	4, 49	625-105	4, 49	625-235E	34
600-251	22	600-3402	43	610-104	5, 48	625-106LL	5, 48	625-235N	34
600-252	22	600-3405	43	610-107	6, 48	625-107	6, 48	625-240	21, 51
600-253	22	600-400	30, 46	610-107DA	6, 48	625-107D5	6, 48	625-2403	34
600-254	22	600-410	30, 40	610-108	6, 48	625-107DA	6, 48	625-240E	34
600-255	22	600-423	35, 43	610-140	9, 48	625-107LL	6, 48	625-240N	34
600-260	22	600-424	35, 43	610-140L	9, 48	625-107RD	6, 48	630-100	39
600-261	22	600-4240	43-45	610-147	11, 48	625-108	6, 48	630-104	39
600-264	22	600-4241	43-45	610-148	11, 49	625-108LL	6, 48	630-105	40
600-266	23	600-4242	43-45	610-149	10, 49	625-109	7, 49	630-107	39
600-267	23	600-425	35	610-163	13, 49	625-109DA	7, 49	630-107IL	39
600-268	23	600-426	35, 44	610-164	13, 49	625-109LL	7, 49	630-108	39
600-269	23	600-4260	44, 45	610-165	13, 49	625-109RD	7, 49	630-110	40
600-270	24	600-4261	44, 45	610-166	13	625-110	16, 50	630-111	40
600-271	23	600-4262	44, 45	615-109	14, 49	625-112	16, 50	630-113	39
600-273	23	600-427	35	615-110	14, 49	625-113	7, 48	630-116	40
600-275	23	600-428	35, 44	615-111	14, 49	625-113LL	7, 48	630-126	40
600-285	24	600-430	44	615-113	15	625-114	7, 48	630-129	40
600-287	24	600-431	35	615-114	15	625-114LL	7, 48	630-129RH	40
600-289	24	600-4320	44, 45	615-116	15	625-115	16, 50	630-147	39
600-290	29	600-440	44	615-118	15	625-117	17, 50	630-164	39
600-291	29	600-441	35	615-143	15	625-118	12, 48	630-164IL	39
600-292	38	600-4420	43-45	615-144	15	625-122	7, 48	630-178	40
600-293	38	600-444	35, 44	615-150	14, 49	625-124	17, 50	630-202	40
600-294	38	600-445	44	615-152	14, 49	625-125	17, 50	630-205	40
600-300	28, 43	600-447	35	615-160	19, 46, 50	625-126	17, 50	630-250	41

630-251..... 41
 630-266..... 41
 630-268..... 41
 630-269..... 41
 630-287..... 41
 630-318.....42
 630-330.....43
 630-3308.....43
 630-340..... 42, 43
 630-427..... 42, 45
 630-429.....42
 630-4300..... 42, 45
 630-4320.....45
 630-4350..... 42, 45
 630-4501.....45
 630-4502.....45
 630-4512.....42
 630-452..... 36, 45
 630-4520.....45
 630-700.....38, 42, 46
 630-730..... 38, 42, 46
 632-100.....39
 632-104.....39
 632-105..... 40
 632-107.....39
 632-107L.....39
 632-108.....39
 632-110..... 40
 632-111..... 40
 632-113.....39
 632-126..... 40
 632-129..... 40
 632-129RH..... 40
 632-147.....39
 632-164.....39
 632-164L.....39
 632-202..... 40
 632-205..... 40
 632-250..... 41
 632-251..... 41
 632-266..... 41
 632-268..... 41
 632-269..... 41
 632-318.....42
 632-3308.....43
 X600-135SPRING..... 46
 X600-320LASER.....43
 X600-322LASER.....43
 X600-580CPCAP..... 46

3.5mm Biopsy Forceps	40	Hasson Cannulas	36, 44-45
3.5mm Dissecting Forceps	40	Herron Articulator Bar Retractor	26
3.5mm Grasping Forceps	39-40	Hook Biopsy Punches	19, 50
3.5mm Laparoscopic Instruments.....	39-42	Hook Electrodes	28
3.5mm Ligation	41	Hook End Suction Coagulator	28
3.5mm Needle Holders	41	Hook Endo Scissors	40
3.5mm Receivers	41	Hook Scissors.....	20, 51
3.5mm Scissors	40	Hook, Appel Dissecting	18
Allis Grasping Forceps.....	7, 48	Hunter Bowel Graspers.....	13, 49
Anvil Grasping Forceps	12, 48	Hunter Clamp.....	13
Appel Dissecting Hook	18	In-line Carb-Bite Needle Holders.....	22, 41
Appel Knot Pushers.....	24, 41	Instrument Holder.....	37, 46
Appel Needle Holders.....	22, 41	Jarit Detach Baby Metzenbaum Scissors	34
Articulator Retractors	26, 48	Jarit Detach Biopsy Forceps.....	34
Articulators.....	26, 48	Jarit Detach Biopsy Punch	34
Atrau-Allis Grasping Forceps.....	7, 39	Jarit Detach Hook Scissors.....	33
Atrau-Allis Long Jaw Grasping Forceps.....	7, 38	Jarit Detach Metzenbaum Scissors	34
Autoclavable Laparoscopes	38, 42, 48	Jarit Detach Micro Scissors	33
Auto-Valve Cannula and Trocar.....	46, 48	Jarit Detach Mini Scissors	34
Auto-Valve Cannulas and Trocars.....	37, 47, 50	Jarit Detach Scissors.....	33-34
Auto-Valve Hasson Cannulas.....	36, 47	Jarit Detach Supercut Scissors.....	33
Babcock Forceps	10-11, 39	Jarit Detach System	33-34
Babcock Forceps, Round Jaw	11, 48	Juliet Receiving Forceps.....	23, 41
Babcock Forceps, Strong Hold.....	10, 49	Knot Pushers	24, 41
Baby Metzenbaum Scissors	34, 57	Laparoscopes	38, 42
Ball Electrode	28	Laparoscopic Case	37
Bariatric Case	37	Large Bipolar Forceps.....	29
Bariatric Endoscope & Instrument Holder	37	Ligation	22-24
Biopsy Forceps	19, 34-35, 40, 50	Light Post Adapters	38
Biopsy Instruments	19, 34-35, 40, 50	Lobe Spleen Extractor.....	14
Biopsy Punch.....	34, 50	L-shaped Hook Electrodes.....	28, 42
Biopsy Punches.....	19, 50	L-shaped Hook Suction Coagulator	28
Bipolar Cable, Wolf Generator	29	Lyons Needle Forceps	23, 41
Bipolar Cables	29	Maryland Dissectors	17, 50, 60
Bipolar Forceps.....	29, 46	Mayo Operating Scissors.....	21, 51
Blunt Suction Coagulator.....	28	Metzenbaum Scissors.....	21, 51
Bowel Forceps	15	Micro Biopsy Forceps	19, 50
Bullet-Nose Dissecting Forceps	17, 50	Micro Bipolar Forceps	29
Cannula & Trocar Pyramid Tip.....	44	Micro Dissecting Forceps	16, 40, 50
Carb-Bite Needle Holders	22, 41	Micro Grasping Forceps.....	16, 50
Cholangiogram Clamp.....	30	Micro Scissors	21, 51
Cholangiogram Guide.....	30, 46	Mini Scissors	21, 51
Claw Forceps	9, 48	Mixer Dissecting Forceps	18, 50
DeBakey Forceps.....	9, 48	Mixer Spreader-Dissectors	18, 50, 60
Dilation Set.....	31	Monopolar Adapter.....	29
Dissecting Forceps	16-18, 40	Monopolar Cable.....	29
DJB Grasping Forceps.....	9, 48	Myoma Screws.....	31
Dual-Cup Grasping Forceps	6, 48	Needle Holders	22-24, 41
Duckbill Grasping Forceps.....	12, 48	Needle Nose Forceps	16, 50
Duval Grasping Forceps	12, 48	Offset Laparoscope	38, 46
Electrodes	28	One-Piece Biopsy Instruments.....	19
Electrosurgical Accessories.....	29	One-Piece Dissecting Forceps	16-18
Electrosurgical Coagulation.....	28-29	One-Piece Electrosurgical Coagulation	28-29
Endoloop Applicator	24, 45	One-Piece Grasping Forceps.....	4-15
Endoscope & Instrument Holder.....	37, 46	One-Piece Laparoscopic Instrumentation.....	3-31
Fallopian Tube, Grasping Forceps.....	15	One-Piece Ligation	22-24
Fan Retractor	27	One-Piece Needle Holders	22-24
Foerster Sponge Forceps	13, 48	One-Piece Receivers	22-24
Fundus Grasping Forceps	6, 39, 48	One-Piece Retracting Instruments	26-27
Grabber Forceps.....	5, 39, 48	One-Piece Retractors.....	26-27
Grasping and Dissecting Forceps.....	8, 49	One-Piece Scissors.....	20-21
Grasping and Extracting Forceps	8, 49	One-Piece Specialization	30-31
Grasping Bipolar Forceps.....	29	Operating Laparoscopes	38
Grasping Forceps	4-15, 39-40, 49	P.E.E.R. Retractors	27, 46
Grasping Forceps, Fallopian Tube.....	15	Paddle Babcock Forceps	10, 49

Palpation Probes31
 Puncture Needles with Irrigation..... 25
 Pyloromyotomy Dissector 40
 Receivers 22-24
 Reducer Flip Top45
 Reducer Sleeves..... 36, 45
 Replacement Parts.....43-46
 Retracting Instruments..... 26-27, 36
 Retraction Grasping Forceps..... 7, 49
 Retractors 26-27, 49
 Retrograde Grasping Forceps..... 8, 49
 Right Angle Dissectors18, 50
 Romeo Self-Righting Needle Holders 23, 41
 Round Jaw Babcock Forceps11, 48
 Russian Grasping Forceps.....12, 49
 Scissors20-21, 33-34, 40
 Spare Parts.....43-46
 Spatula Electrodes.....28
 Spatula Tip Suction Coagulator28
 Specialization.....30-31
 Spoon Forceps 30, 50
 S-Retractors.....36
 Stone Extractor 14
 Storage and Accessories.....37
 Strong Atraumatic Grasping Forceps.....15
 Strong Forceps 14, 40, 49
 Strong Hold Babcock Forceps.....10, 49
 Strong TC Grasping Forceps.....5, 49
 Suction Coagulators28, 43
 Suction/Irrigation Cannulas 25, 42, 43
 Suction/Irrigation Set25, 43
 Supercut Endo Scissors 20, 30
 Supercut Scissors 20, 33, 40, 51
 Suturing Set24
 Swanstrom Grasping Forceps11, 49
 Tapered Dissecting Forceps16, 50
 Tapered Maryland Dissectors17, 50
 TC Grasping Forceps 4, 49
 Tenaculum Forceps.....14, 49
 Thoracic Cannula 36, 44
 Trocar/Cannula System.....35-36, 43-45
 Trocars.....35, 42
 Vein/Nerve Retractor26
 Veress Needles.....31
 Winer Grasping Forceps 8
 Wolf Generator Bipolar Cable.....29





Availability of these products might vary from a given country or region to another, as a result of specific local regulatory approval or clearance requirements for sale in such country or region.

- Non contractual document. The manufacturer reserves the right, without prior notice, to modify the products in order to improve their quality.
- Warning: Applicable laws restrict these products to sale by or on the order of a physician.
- Consult product labels and inserts for any indication, contraindications, hazards, warnings, precautions, and instructions for use.

For more information or to place an order, please contact:

United States, Canada, Asia, Pacific, Latin America

USA 800-654-2873 ■ 888-980-7742 fax

International +1 609-936-5400 ■ +1 609-750-4259 fax

integralife.com

Manufacturer:



Integra LifeSciences Production Corporation

11 Cabot Boulevard

Mansfield, MA 02048 USA